

COURSES OF STUDY 2021-2022



INDIAN INSTITUTE OF TECHNOLOGY DELHI

VISION

To contribute to India and the World through excellence in scientific and technical education and research; to serve as a valuable resource for industry and society; and remain a source of pride for all Indians.

MISSION

To generate new knowledge by engaging in cutting-edge research and to promote academic growth by offering state-of-the-art undergraduate, postgraduate and doctoral programmes.

To identify, based on an informed perception of Indian, regional and global needs, areas of specialization upon which the Institute can concentrate.

To undertake collaborative projects which offer opportunities for long-term interaction with academia and industry.

To develop human potential to its fullest extent so that intellectually capable and imaginatively gifted leaders can emerge in a range of professions.

VALUES

- Academic integrity and accountability.
- Respect and tolerance for the views of every individual.
- Attention to issues of national relevance as well as of global concern.
- Breadth of understanding, including knowledge of the human sciences.
- Appreciation of intellectual excellence and creativity.
- An unfettered spirit of exploration, rationality and enterprise.

COURSES OF STUDY 2021-2022

Undergraduate Programmes

Bachelor of Technology

Dual Degree (B.Tech. + M.Tech.)

Postgraduate Programmes

P.G. Diploma of I.I.T. Delhi

Master of Science

Master of Business Administration

Master of Design

Master of Technology

Master of Science (Research)

Master of Public Policy

Doctor of Philosophy



INDIAN INSTITUTE OF TECHNOLOGY DELHI

Hauz Khas, New Delhi 110 016, India.

<http://www.iitd.ac.in>

This book is available at the IIT Delhi website:

<http://www.iitd.ac.in>

Link:<https://home.iitd.ac.in/curriculum.php>

In case of queries, please visit IIT Delhi website or contact:

Undergraduate Programme
Assistant Registrar (Academics - UGS)

Ph. : +91 11 2659 1718

E-mail : arugs@iitd.ac.in
drpgsr@iitd.ac.in
adcur@admin.iitd.ac.in
deanacad@admin.iitd.ac.in

Postgraduate Programme

Joint Registrar (PGS&R)

Ph. : +91 11 2659 1737

E-mail : drpgsr@iitd.ac.in
adres@admin.iitd.ac.in
deanacad@admin.iitd.ac.in

Copyright : © IIT Delhi

Produced by : Publication Cell, IIT Delhi

August 2021

CONTENTS

1.	INTRODUCTION	1-6
1.1	Background	1
1.2	Departments, Centres and Schools	1
1.3	Programmes Offered	2
1.4	Entry Number	6
1.5	Honour Code	6
2.	COURSE STRUCTURE AND CREDIT SYSTEM	6-13
2.1	Course Numbering Scheme	6
2.2	Credit System	7
2.3	Assignment of Credits to Courses	7
2.4	Earning Credits	8
2.5	Description of Course Content	8
2.6	Pre-requisite(s)	9
2.7	Overlapping/ Equivalent Courses	9
2.8	Course Coordinator	9
2.9	Grading System	9
2.10	Evaluation of Performance	12
3.	REGISTRATION AND ATTENDANCE	13-16
3.1	Registration	13
3.2	Registration and Student Status	14
3.3	Advice on Courses	14
3.4	Validation of Registration	14
3.5	Minimum Student Registration in a Course	14
3.6	Late Registration	14
3.7	Add/Drop, Audit and Withdrawal of Courses	14
3.8	Semester Withdrawal	15
3.9	Registration in Special Module Courses	15
3.10	Registration for Non-graded Units	15
3.11	Pre-requisite Requirement(s) for Registration	15
3.12	Overlapping/ Equivalent Courses	15
3.13	Limits on Registration	16
3.14	Registration and Fee Payment	16
3.15	Continuous Absence and Registration Status	16
3.16	Attendance Rule	16
4.	UNDERGRADUATE DEGREE REQUIREMENTS, REGULATIONS AND PROCEDURES	17-27
4.1	Overall Requirements	17
4.2	Breakup of Degree Requirements	17
4.3	Non-graded Core Requirement	19
4.4	Minimum and Maximum Durations for Completing Degree Requirements	20
4.5	Absence During the Semester	21
4.6	Conditions for Continuation of Registration, Termination/Re-start, Probation and Warning	22
4.7	Scheme for Academic Advising of Undergraduate Students	23
4.8	Capability Linked Opportunities for Undergraduate Students	24
4.9	Change of Programme at the End of the First Year	25
4.10	Self-study Course	26
4.11	Assistantship for Dual-degree Programmes	27
4.12	Admission of UG Students to PG Programmes	27
4.13	Measures for Helping SC/ST Students	27
5.	POSTGRADUATE DEGREE REQUIREMENTS, REGULATIONS and PROCEDURES	28-36
5.1	Degree Requirements	28
5.2	Continuation Requirements	28
5.3	Minimum Student Registration for a Programme	28
5.4	Lower and Upper Limits for Credits Registered	28
5.5	Audit Courses for PG Students	28
5.6	Award of D.I.I.T. to M.Tech./M.B.A. Students	29

5.7	Regulations for Part-time Students	29
5.8	Leave Rules for P.G. D.I.I.T., M.Des., M.Tech. and M.S. (Research).....	29
5.9	Assistantship Requirements	29
5.10	Summer Registration.....	29
5.11	Master of Science (Research) Regulations.....	30
5.12	Migration from one PG Programme to another PG Programme of the Institute.....	30
5.13	Doctor of Philosophy (Ph.D.) Regulations.....	30
6.	SPECIAL PROVISIONS (ONLINE TEACHING OWING TO COVID-19) FOR SEMESTER I OF ACADEMIC YEAR 2021-22 FOR OTHER THAN UG FIRST YEAR COURSES	37-38
6.1	Special Provisions on Grading, and Registration for the Semesters Conducted Online.....	37
6.2	Special Provisions on Continuation/ Termination of Registration and Assistantships for the Semesters Conducted Online.....	37
6.3	Special Provisions Applicable to Ph.D./ M.S.(R) Students.....	38
7.	UNDERGRADUATE PROGRAMME STRUCTURES	39-76
8.	CAPABILITY-LINKED OPTIONS FOR UNDERGRADUATE STUDENTS	77-87
9.	NON-GRADED CORE FOR UNDERGRADUATE STUDENTS	88-101
9.1	Introduction to Engineering and Programme	88
9.2	Language and Writing Skills.....	89
9.3	NCC/ NSO/ NSS	89
9.4	Professional Ethics and Social Responsibility.....	90
9.5	Communication Skills/Seminar	92
9.6	Design/ Practical Experience	93
9.7	Overlapping Activities.....	101
10.	POSTGRADUATE PROGRAMME STRUCTURES.....	102-162
11.	COURSE DESCRIPTIONS	163-387
	Department of Applied Mechanics	164
	Department of Biochemical Engineering and Biotechnology.....	174
	Department of Chemical Engineering.....	179
	Department of Chemistry	188
	Department of Civil Engineering	193
	Department of Computer Science and Engineering	212
	Department of Design	222
	Department of Electrical Engineering.....	224
	Department of Energy Science and Engineering	245
	Department of Humanities and Social Sciences	259
	Department of Management Studies	281
	Department of Materials Science and Engineering	300
	Department of Mathematics.....	308
	Department of Mechanical Engineering.....	319
	Department of Physics	334
	Department of Textile and Fibre Engineering.....	348
	Centre for Applied Research in Electronics	357
	Centre for Atmospheric Sciences	360
	Centre for Automotive Research and Tribology (Formerly ITMMEC).....	365
	Centre for Biomedical Engineering.....	368
	National Resource Centre for Value Education in Engineering.....	371
	Centre for Rural Development and Technology.....	372
	Centre for Sensors, Instrumentation and Cyber-Physical Systems Engineering (Formerly IDDC)	375
	Amar Nath and Shashi Khosla School of Information Technology	377
	Kusuma School of Biological Sciences	378
	Bharti School of Telecommunication Technology and Management	384
	School of Public Policy	384
	Interdisciplinary M.Tech. Programmes	386
	ABBREVIATIONS	388
	SLOT TIMINGS.....	389

1. INTRODUCTION

1.1 Background

At the undergraduate level, IIT Delhi provides science-based engineering education with a view to produce quality engineer-scientists. Every B.Tech. student needs to do compulsory foundation courses in the areas of basic sciences, humanities, social sciences and engineering sciences apart from departmental requirements in his/her core engineering discipline. Departmental courses (core and electives) constitute about half of the total curriculum. Further, students do open category electives to develop broad inter-disciplinary knowledge base or to specialize significantly in an area outside the parent discipline. Many activities are included in the undergraduate curriculum as non-graded core with a view to enhance the quality of learning. The curriculum provides broad based knowledge and simultaneously builds a temper for a lifelong process of learning and exploring. At present, IIT Delhi offers 14 B.Tech. programmes and 3 Dual Degree (integrated B.Tech. and M.Tech.) programmes.

IIT Delhi also offers multiple Postgraduate Programmes (M.Sc./M.Tech./M.S.(Research)/M.Des./M.B.A./M.P.P./Ph.D.) through its Departments, Centres, and Schools. Currently, there are 35 M.Tech., 6 Interdisciplinary M.Tech., 15 M.S.(R.), 5 M.Sc., 1 M.Des., 3 M.B.A. (including part time), 1 M.P.P. and 31 Ph.D. programmes offered by different academic units. In addition, there are 2 joint Ph.D. and 1 joint PG Diploma programmes being offered in collaboration with partner institutions. The Institute has multiple courses at appropriate levels to cater to the academic requirements of the Postgraduate students. New courses are also being continuously added to the existing pool of PG and Pre-Ph.D. courses. At the postgraduate level, students are also encouraged to look beyond their area of specialization to broaden their horizons through open electives and self-learning.

The medium of instruction in the Institute is English.

The Institute follows a semester system. An academic year typically runs from July through June next year and is essentially comprised of two semesters. Typically, the 1st semester starts in the last week of July and ends in the 1st week of December; the 2nd semester starts in the 1st week of January and ends in the 2nd week of May. Additionally, the summer semester which starts in the 3rd week of May and ends in the 2nd week of July, is utilized in some exceptional cases. Detailed schedule is given in the Semester Schedule that is made available before the start of each semester.

1.2 Departments, Centres and Schools

Each course is offered by an Academic Unit which could be a Department, a Centre or a School. The names of Departments, Centres and Schools and their two-letter codes are given in Table 1. Some programmes are offered jointly by multiple academic units and are classified as interdisciplinary programmes; their codes are given in Table 2.

Table 1: Academic Departments, Centres and Schools

Name of Academic Unit (alphabetical order)	Code of Academic Unit	Course Prefix
Applied Mechanics, Department of	AM	AP
Applied Research in Electronics, Centre for	CR	CR
Artificial Intelligence, School of	AI	-*
Atmospheric Sciences, Centre for	AS	AS
Automotive Research and Tribology, Centre for	CT	IT
Biochemical Engineering and Biotechnology, Department of	BE	BB
Biological Sciences, Kusuma School of	BL	SB
Biomedical Engineering, Centre for	BM	BM
Chemical Engineering, Department of	CH	CL
Chemistry, Department of	CY	CM
Civil Engineering, Department of	CE	CV
Computer Science and Engineering, Department of	CS	CO
Design, Department of	DD	DD
Electrical Engineering, Department of	EE	EL
Energy Science and Engineering, Department of	ES	ES

Humanities and Social Sciences, Department of	HU/HS	HU/HS
Information Technology, Amar Nath and Shashi Khosla, School of	AN/SI	SI
Interdisciplinary Research, School of	SR	-*
Management Studies, Department of	SM	MS/MD
Materials Science and Engineering, Department of	MS	PT
Mathematics, Department of	MA	MT
Mechanical Engineering, Department of	ME	MC
Optics and Photonics, Centre	-*	-*
Physics, Department of	PH	PY
Public Policy, School of	PP	SP
Rural Development and Technology, Centre for	RD	RD
Sensors, Instrumentation and Cyber-Physical Systems Engineering, Centre for	ID	DS
Telecommunication Technology and Management, Bharti School of	BS	BS
Textile and Fibre Engineering, Department of	TT	TX
Transportation Research and Injury Prevention, Centre	TR	-*
Value Education in Engineering, National Resource, Centre for	VE	VE

*New academic entities, unit and course prefix yet to be assigned.

1.3 Programmes Offered

IIT Delhi offers a variety of academic programmes for students with a wide range of backgrounds. Admission to many of these programmes are based on performance in national level tests/entrance examinations. Details are given in the Prospectus.

The programmes offered by IIT Delhi are presently classified as Undergraduate (UG) and Postgraduate (PG) programmes. This classification is based primarily on entry/admission qualification of students rather than the level of degree offered. For all undergraduate programmes, students are admitted after 10+2 years of schooling while for all postgraduate programmes, students are admitted after they have obtained at least a college level Bachelor's degree. Various programmes offered and their specializations are listed below.

A. Bachelor of Technology: (B.Tech.)

Department	Programme	Code
Applied Mechanics	B.Tech. in Engineering and Computational Mechanics	AM1
Biochemical Engg. and Biotechnology	B.Tech. in Biochemical Engineering and Biotechnology	BB1
Chemical Engineering	B.Tech. in Chemical Engineering	CH1
Computer Science and Engineering	B.Tech. in Computer Science and Engineering	CS1
Civil Engineering	B.Tech. in Civil Engineering	CE1
Electrical Engineering	B.Tech. in Electrical Engineering	EE1
	B.Tech. in Electrical Engineering (Power and Automation)	EE3
Energy Science and Engineering	B.Tech. in Energy Engineering	ES1
Materials Science and Engineering	B.Tech. in Materials Engineering	MS1
Mathematics	B. Tech. in Mathematics & Computing	MT1
Mechanical Engineering	B.Tech. in Mechanical Engineering	ME1
	B.Tech. in Production and Industrial Engineering	ME2
Physics	B.Tech. in Engineering Physics	PH1
Textile and Fibre Engineering	B.Tech. in Textile Technology	TT1

B. Dual-Degree : (B.Tech. and M.Tech.)

Department	Programme	Code
Chemical Engineering	B.Tech. and M.Tech. in Chemical Engineering	CH7
Computer Science and Engineering	B.Tech. and M.Tech. in Computer Science and Engineering	CS5
Mathematics	B.Tech. and M.Tech. in Mathematics & Computing	MT6

C. Master of Technology: (M.Tech.)

Department/Centre	Programme	Code
Applied Mechanics	M.Tech. in Engineering Analysis and Design	AMA
Chemical Engineering	M.Tech. in Chemical Engineering	CHE
Chemistry	M.Tech. in Molecular Engg. : Chemical Synthesis & Analysis	CYM
Civil Engineering	M.Tech. in Geotechnical and Geoenvironmental Engineering	CEG
	M.Tech. in Rock Engineering and Underground Structures	CEU
	M.Tech. in Structural Engineering	CES
	M.Tech. in Water Resources Engineering	CEW
	M.Tech. in Construction Engineering and Management	CET
	M.Tech. in Construction Technology and Management (*)	CEC
	M.Tech. in Environmental Engineering and Management	CEV
	M.Tech. in Transportation Engineering	CEP
Computer Science & Engineering	M.Tech. in Computer Science and Engineering	MCS
Electrical Engineering	M.Tech. in Communications Engineering	EEE
	M.Tech. in Computer Technology	EET
	M.Tech. in Control and Automation	EEA
	M.Tech. in Integrated Electronics and Circuits	EEN
	M.Tech. in Power Electronics, Electrical Machines and Drives	EEP
	M.Tech. in Power Systems	EES
Energy Science and Engineering	M.Tech. in Energy & Environment Technologies and Management	ESN
	M.Tech. in Renewable Energy Technologies and Management*	ESR
Materials Science & Engineering	M.Tech. in Materials Engineering	MSM
	M.Tech. in Polymer Science and Technology	MSP
Mechanical Engineering	M.Tech. in Mechanical Design	MEM
	M.Tech. in Industrial Engineering	MEE
	M.Tech. in Production Engineering	MEP
	M.Tech. in Thermal Engineering	MET
Physics	M.Tech. in Applied Optics	PHA
	M.Tech. in Solid State Materials	PHM
Textile and Fibre Engineering	M.Tech. in Fibre Science & Technology	TTF
	M.Tech. in Textile Engineering	TTE
	M.Tech. in Textile Chemical Processing	TTC
Applied Research in Electronics	M.Tech. in Radio Frequency Design and Technology	CRF

Atmospheric Sciences	M.Tech. in Atmospheric-Oceanic Science and Technology	AST
Automotive Research & Tribology	M.Tech. in Electric Mobility	CTE
Biomedical Engineering	M.Tech. in Biomedical Engineering	BMT
Energy Science and Engineering	M.Tech. in Energy & Environment Technologies and Management	ESN
	M.Tech. in Renewable Energy Technologies and Management*	ESR
Interdisciplinary Programme	M.Tech. in Cyber Security	JCS
	M.Tech. in Energy Studies	JES
	M.Tech. in Industrial Tribology and Maintenance Engineering#	JIT
	M.Tech. in Instrument Technology	JID
	M.Tech. in Optoelectronics and Optical Communication	JOP
	M.Tech. in Telecommunication Technology Management	JTM
	M.Tech. in VLSI Design Tools and Technology (*)	JVL

NOTE: * Sponsored programmes. # Temporarily suspended.

D. Master of Science (Research): M.S.(R)

Department/School	Code
Amar Nath and Shashi Khosla School of Information Technology	SIY
Applied Mechanics	AMY
Automotive Research and Tribology	CTY
Bharti School of Telecommunication Technology and Management	BSY
Biochemical Engineering and Biotechnology	BEY
Chemical Engineering	CHY
Civil Engineering	CEY
Computer Science and Engineering	CSY
Electrical Engineering	EEY
Energy Science and Engineering	ESY
Materials Science and Engineering	MSY
Mechanical Engineering	MEY
Kusuma School of Biological Sciences	BLY
VLSI Design Tools and Technology	JVY
Sensors, Instrumentation and Cyber-Physical Systems Engineering	IDY

E. Master of Design: (M.Des.)

Department	Programme	Code
Design	Master of Design in Industrial Design	DDS

F. Master of Business Administration: (M.B.A.)

Department	Programme	Code
Management Studies	M.B.A.	SMG
	M.B.A. (with focus on Telecommunication Systems Management)	SMT
	M.B.A. (with focus on Technology Management) (part-time and evening programme)	SMN

G. Master of Science: (M.Sc.)

Department	Programme	Code
Chemistry	M.Sc. in Chemistry	CYS
Humanities and Social Sciences	M.Sc. in Cognitive Science	HCS
	M.Sc. in Economics	HES
Mathematics	M.Sc. in Mathematics	MAS
Physics	M.Sc. in Physics	PHS

G. Master of Public Policy (M.P.P.)

Department	Programme	Code
School of Public Policy	Master of Public Policy	PPM

I. Postgraduate Diploma

Department	Programme	Code
Applied Mechanics	P.G. D.I.I.T (Naval Construction) (for candidates sponsored by the Indian Navy)	AMX
Mechanical Engineering	Joint P.G. Diploma in Visionary Leadership in Manufacturing (VLFM) (Jointly with NITIE Mumbai)	MVX

The DIIT is also awarded under special circumstances in every Master of Technology programme listed in item C above. It is awarded only to those students who have not been able to complete the requirements of the corresponding M.Tech. degree. For details please see Section 5.6.

J. Doctor of Philosophy: (Ph.D.)

All Departments, Centres and Schools listed in Section 1.2 offer Ph.D. programmes. In addition, two joint Ph.D. programmes are offered in association with The University of Queensland Australia and National Chiao Tung University Taiwan. The two-letter code of the academic unit followed by Z corresponds to the Ph.D. code of the respective academic unit. (e.g. MAZ is the Ph.D. code of the Mathematics Department).

1.4 Entry Number

The entry number of a student consists of eleven alpha-numerals, as described below:

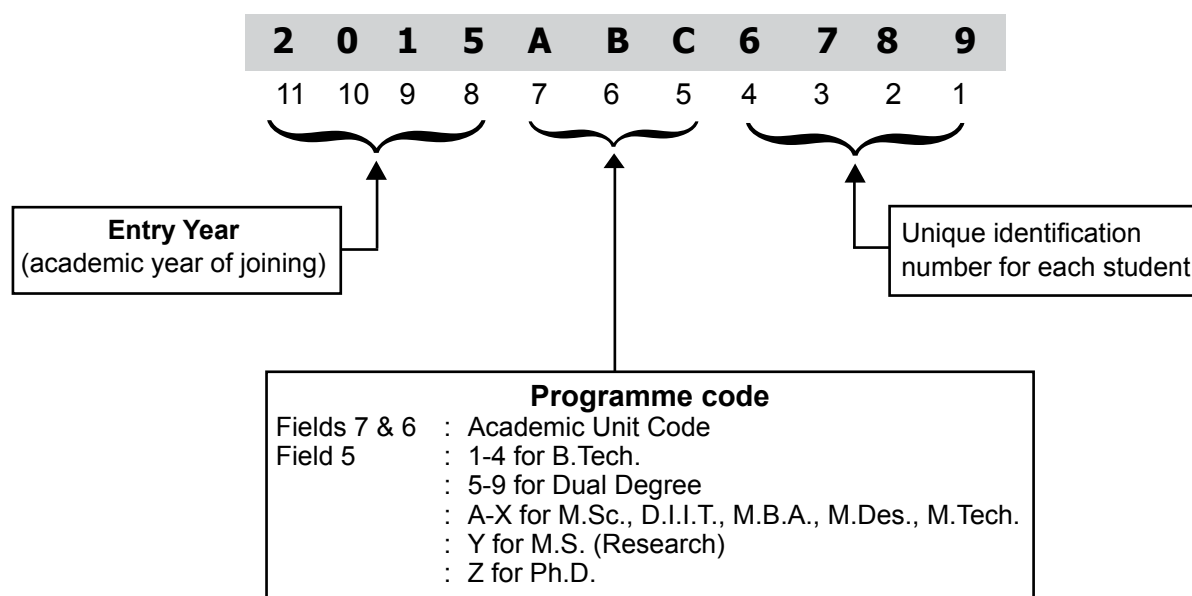

In case of change in Programme by a student, the programme code in his/her entry number (fields 5, 6 and 7) will be changed. However, his/her unique identification number will remain unchanged. Such students will have two entry numbers, one prior to programme change and one after the change. However, any time, only one entry number, that corresponds to the student's present status will be valid and active.

1.5 Honour Code

The Honour Code of IIT Delhi is given at the end of this document. Every student signs this Honour Code at the time of admission and is expected to adhere to the Honour Code throughout the period of his/her studies at the Institute.

2. COURSE STRUCTURE AND CREDIT SYSTEM

2.1 Course Numbering Scheme

Normally every course at IIT Delhi runs for the full length of the semester. Only exception is for V-type courses which may run for part of the semester. A student registers in advance for courses that he/she wants to study and at the end of the semester a grade is awarded. On obtaining a pass grade, the student earns all the credits associated with the course while a fail grade does not get any credit. Partial credits are not awarded.

Each course is denoted by a unique code consisting of three alphabets followed by three numerals:

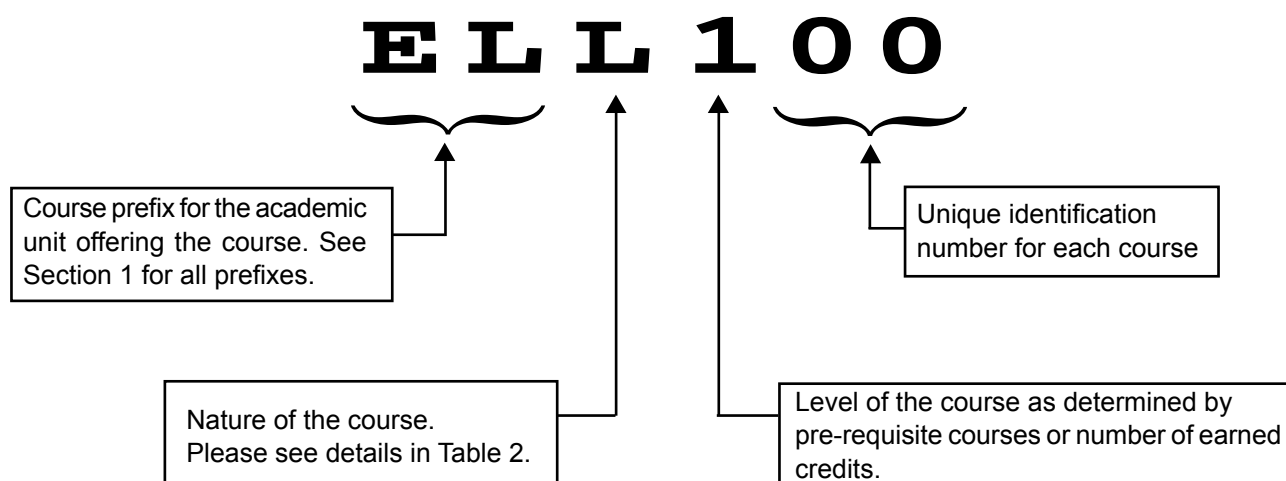

(a) Codes for the nature of the course**Table 2: Codes for the nature of courses.**

Code	Description
D	Project based courses (e.g. Major, Minor, Mini Projects)
L	Lecture courses (other than lecture hours, these courses can have Tutorial and Practical hours, e.g. L-T-P structures 3-0-0, 3-1-2, 3-0-2, 2-0-0, etc.)
N	Non-graded core component
P	Practical/Practice based courses (where performance is evaluated primarily on the basis of practice, practical or laboratory work with LTP structures such as 0-0-3, 0-0-4, 1-0-3, 0-1-3, etc.)
Q	Seminar Courses
R	Professional Practices
S	Independent Study
T	Practical Training
V	Lecture Courses on Special Topics (1 or 2 credits)

(b) Level of the course

The first digit of the numeric part of the course code indicates the level of the course as determined by pre-requisite course(s) and/or by the maturity required for registering for the course. The latter requirement is enforced through a requirement of minimum number of earned credits. In general,

- 100 – 400 level courses : Core and elective courses for UG programmes.
These courses are not open to any PG student.
- 500 level courses : Courses for M.Sc. programmes.
These courses are not open to other students.
- 600 level courses : Preparatory/introductory courses for M.Tech. and advanced courses for M.Sc. programmes. 500 and 600 level courses are normally not open to UG students.
- 700 - 800 level courses : Core and elective courses for M.Tech., M.Des., M.B.A., M.S.(Research) and Ph.D. programmes. Usually 800 level courses are advanced courses for PG students.

2.2 Credit System

Education at the Institute is organized around the semester-based credit system of study. A student is allowed to attend classes in a course and earn credit for it, only if he/she has registered for that course. Prominent features of the credit system are a process of continuous evaluation of a student's performance/progress and flexibility to allow a student to progress at an optimum pace suited to his/her ability or convenience, subject to fulfilling minimum requirements for continuation and within the maximum allowable period for completion of a degree.

A student's performance/progress is measured by the number of credits that he/she has earned, i.e. completed satisfactorily. Based on the course credits and grades obtained by the student, grade point average is calculated. A minimum grade point average is required to be maintained for satisfactory progress and continuation in the programme. Also, a minimum number of earned credits and a minimum grade point average should be acquired in order to qualify for the degree. All programmes are defined by the total credit requirement and a pattern of credit distribution over courses of different categories as defined in sections 4 and 5 for UG and PG programmes respectively.

2.3 Assignment of Credits to Courses

Each course has a certain number of credit(s) or non-graded unit(s) assigned to it depending upon its lecture, tutorial and laboratory/practical contact hours in a week. This weightage is also indicative of the academic expectation that includes in-class contact and self-study outside class hours.

- Lectures and Tutorials** : One lecture or tutorial hour per week over the period of one 14 week semester is assigned one credit.
- Practical/Practice** : One laboratory/practice hour per week over the period of one 14 week semester is assigned half credit.

A few courses are without credit and are counted under non-graded (NG) courses.

Example : Course COL334 Computer Networks; 4 credits (3-0-2)

The credits indicated for this course are computed as follows:

3 hours/week lectures	= 3 credits	}	Total = 3 + 0 + 1 = 4 credits
0 hours/week tutorial	= 0 credit		
2 hours/week practicals	= 2 × 0.5 = 1 credit		

Total contact hours for the course = (3 h Lectures + 0 h Tutorial + 2 h Practical) per week
= 5 contact hours per week for 14 weeks.

For each lecture or tutorial credit, the self-study component is 1-2 hours/week (for 100-600 level courses) and 3 hours/week (for 700-800 level courses). The self-study component for practicals is 1 hour for every two hours of practicals per week. In the above example, the student is expected to devote a minimum of 3 + 1 = 4 hours per week on self-study in addition to class contact of 5 hours per week.

2.4 Earning Credits

At the end of every semester, a letter grade is awarded in each course for which a student had registered. On obtaining a pass grade, the student accumulates the course credits as earned credits. An undergraduate student has the option of auditing some courses within the credit requirements for graduation. Grades obtained in audit courses are not counted for computing of grade point average. However, a pass grade is essential for earning credits from an audit course. Section 2.9 defines the letter grades awarded at IIT Delhi and specifies the minimum grade for passing a course.

2.5 Description of Course Content

Course content description consists of following components: (i) Course Number, (ii) Title of the Course, (iii) Credit and L-T-P, (iv) Pre-requisite(s) and overlapping courses, if any, and (v) List of broad topics covered in the course. Content descriptions for all courses are given in section 10 of this document. An example course content description of a 100 level course is as follows:

MTL100 Calculus

4 Credits (3-1-0)

Review of Limit, Continuity and Differentiability, uniform continuity, Mean Value Theorems and applications, Taylor's Theorem, maxima and minima, sequences and series, limsup, liminf, convergence of sequences and series of real numbers, absolute and conditional convergence.

Reimann Integral, fundamental theorem of integral calculus, applications of definite integrals, improper integrals, beta and gamma functions.

Functions of several variables, limit and continuity, partial derivatives and differentiability, gradient, directional derivatives, chain rule, Taylor's theorem, maxima and minima and method of Lagrange Multipliers.

Double and triple integration, Jacobian and change of variables formula. Parametrization of curves and surfaces, vector fields, divergence and curl, line integrals, Green's theorem, surface integral, Gauss and Stokes theorems with applications.

2.6 Pre-requisite(s)

Each course, other than 100 level courses, may have specified pre-requisite(s) which may be other course(s), or a minimum number of earned credits, or both. A student who has not obtained a pass grade in the pre-requisite(s) specified or has not earned requisite number of credits will not be eligible to register for that course. For example:

TXL372 Speciality Yarns and Fabrics

2 credits (2-0-0)

Pre-requisite(s): TXL221/TXL222 and TXL231/TXL232 and EC50

A student who has obtained a pass grade in TXL221 or TXL222, and in TXL231 or TXL232 and has also earned 50 credits will be eligible to register for this course.

For UG students the Pre-requisite(s) for some courses of special nature are given below.

Independent Study	65 earned credits
Mini Project	65 earned credits
Minor Project (Dual Degree)	100 earned credits
B.Tech. Project Part - I	100 earned credits
B.Tech. Project Part - II	Minimum B Grade in B.Tech. Project Part - I
M.Tech. Major Project Part-I (Dual Degree)	135 earned credits

In addition to any pre-requisite specified for 700 and 800 level courses, a UG student needs to earn 75 and 100 credits to register for 700 and 800 level courses, respectively.

2.7 Overlapping/Equivalent Courses

Wherever applicable, overlapping and equivalent courses have been identified for each course. A student is not permitted to earn credits by registering for more than one course in a set of overlapping/equivalent courses. Departments/Centres/Schools may use these overlapping/equivalent courses for meeting degree/pre-requisite requirements in special circumstances. For example:

CLL113 Numerical Methods in Chemical Engineering

4 Credits (3-0-2)

Overlaps with: MTL107, MTP290, MTL445, CVL734, COL726

A student who has earned a pass grade in CLL113 will not be eligible to register for MTL107, MTP290, MTL445, CVL734 or COL726. An overlapping course cannot serve as a substitute for a core course of his/her programme. In the above example, if MTL107 is a core course for a student, he/she is not allowed to register for CLL113 as a substitute for this core course.

2.8 Course Coordinator

Every course is usually coordinated by a member of the teaching staff of a Department/Centre/School in a given semester. This faculty member is designated as the Course Coordinator. He/she has the full responsibility for conducting the course, coordinating the work of other members of the faculty and teaching assistants involved in that course, administering assignments, conducting the tests as well as moderating and awarding the grades. For any difficulty related to a course, the student is expected to approach the respective course coordinator for advice and clarification. The distribution of the weightage for tests, quizzes, assignments, laboratory work, workshop and drawing assignment, term paper, etc. that will be the basis for award of grade in a course will be decided by the course coordinator of that course, in consultation with other teachers involved, and announced at the beginning of the semester.

2.9 Grading System

The grade obtained in a course reflects a student's performance in the course. While relative standing of the student is indicated by his/her grades, the process of awarding grades is not necessarily based upon fitting the marks scored by the students to some statistical distribution. The course coordinator and associated faculty for a course formulate appropriate procedure to award grades that are reflective of the student's performance vis-à-vis the expected learning outcomes of the course.

2.9.1 Grade points

The grades and their equivalent numerical points (referred to as Grade Points) are listed in Table 3.

Table 3: Grades and their description.

Grade	Grade points	Description
A	10	Outstanding
A (-)	9	Excellent
B	8	Very good
B (-)	7	Good
C	6	Average
C (-)	5	Below average
D	4	Marginal
E	2	Poor
F	0	Very poor
I	-	Incomplete
NP	-	Audit pass
NF	-	Audit fail
W	-	Withdrawal
X	-	Project/Ph.D. Continuation
S	-	Satisfactory completion
Z	-	Course continuation
U	-	Unsatisfactory progress in Ph.D.

2.9.2 Description of grades

A grade

An 'A' grade stands for outstanding achievement. The minimum marks for award of an 'A' grade is 80 %. However, individual course coordinators may set a higher marks requirement for awarding an 'A' grade.

C grade

The 'C' grade stands for average performance. This is the minimum grade required to pass in the Major Project Part 1 and Part 2 of Dual degree and 2 year M.Tech. and M.S.(R) Programmes.

D grade

The 'D' grade stands for marginal performance; i.e. it is the minimum passing grade in any course excluding the M.Tech. Major Project. The minimum marks for award of 'D' grade is 30 %. However, individual course coordinators may set a higher marks requirement.

E and **F** grades

A student who has scored at least 20% aggregate marks in a subject can be awarded an 'E' Grade. The Course Coordinators are, however, free to enhance this limit but should keep the percentage about 10% less than the cut-off marks for 'D' Grade. The Course Coordinators can also specify any additional requirements (to be specified at the beginning of the Semester) for awarding 'E' Grade. Students who obtain an 'E' Grade will be eligible to appear in a repeat major test (re-major test), an examination with weightage same as that of Major test, for only lecture courses ('L' Category Courses described in section 2.1). If they perform satisfactorily, they become eligible for getting the grade converted to a 'D' Grade, otherwise they will continue to have 'E' Grade. The student will have only one chance to appear for re-major for an 'E' Grade. The re-major test will be conducted within the first week of the next semester. The date of re-major test of Institute core courses for undergraduate students will be

centrally notified, while for all other courses, the date would be announced by the respective course coordinators. A student can appear for a maximum of three such re-major tests in a given semester. If a student cannot appear for the re-major test due to any reason(s), he/she will not get any additional chance.

If a student with 'E' grade in a course does not pass the course through a re-major test or obtains an 'F' grade in the course, he/she has to repeat the course if it is a core course. In case the course is an elective, the student may take the same course again or any other course from the same category. 'E' and 'F' Grades are not counted in the calculation of the CGPA; however, these are taken into account in the calculation of the SGPA. (Please see 2.10 for definitions)

I grade

An 'I' grade is temporarily awarded to a student on his/her request to denote incomplete performance in L (lecture), P (practical), V (special module) category courses. Requests for 'I' grade should be made at the earliest but not later than the last day of major tests. An 'I' grade is awarded in case of absence on medical grounds or other special circumstances, before or during the major examination period, provided the student has met the attendance criterion of the course. Attendance in the course for which 'I' grade is being sought will be certified by the course coordinator of the course. The course coordinators can instruct all students awarded 'I' grade as well as 'E' grade to appear for a common re-major test. All evaluation requirements for such students in the corresponding course(s) should be completed before the end of the first week of the next semester. Upon completion of all course requirements, the 'I' grade is converted to a regular grade (A to F, NP or NF).

NP and NF grades

These grades are awarded in a course that the student opts to audit. Only elective courses can be audited. Auditing a course is allowed until a date stipulated in the semester schedule. The audit pass (NP) grade is awarded if the student's attendance is above 75% in the class and he/she has obtained at least 'D' grade. The course coordinator can specify a higher criterion, at the beginning of the semester, for audit pass. If the stipulated requirements are not fulfilled, the audit fail (NF) grade is awarded. The grades obtained in an audit course are not considered in the calculation of SGPA, CGPA or DGPA. However, for undergraduate students, the credits will be counted in total earned credits in the respective category, subject to the maximum allowable limit for audit.

W grade

A 'W' grade is awarded in a course from which the student has opted to withdraw. Withdrawal from a course is permitted until the date specified in the Semester Schedule. Withdrawal from PG major project part 2 is allowed only if he/she is given semester withdrawal. The W grade is mentioned on the grade card.

X grade

The 'X' grade is awarded for incomplete work in Independent Study, Mini Project, Minor Project, or Major Project Part 1 and Part 2, based on the request of the student. On completion of the work, 'X' grade can be converted to a regular grade within the first week of the next semester. Otherwise, the student will be awarded 'X' grade on a permanent basis and it will appear in his/her grade card. Further, the student will be required to register for the course in the next semester. The credits of the course will be counted towards his/her total load for the semester. In case of Major Project Part 1, the student will not be permitted to register for Major Project Part 2 simultaneously as Major Project Part 1 is a pre-requisite for Major Project Part 2. A regular full-time student can be awarded 'X' grade only once in a course, other than the summer semester. A part-time M.Tech. student is permitted a maximum of two X-grades in the Major Project part-2.

S and Z grades

The 'S' grade denotes satisfactory performance and completion of a course. The 'Z' grade is awarded for non-completion of the course requirements, and if it is a core course, the student will have to register for the course until he/she obtains the 'S' grade. The specific courses in which 'S' or 'Z' grades are awarded for undergraduate students are:

- (i) Introduction to Engineering and Programme
- (ii) Language and Writing skills
- (iii) NCC /NSO /NSS
- (iv) Professional Ethics and Social Responsibility
- (v) Communication Skills/Seminar
- (vi) Design/Practical Experience

Besides, summer/winter internships in some PG programmes are also awarded S/Z.

2.10 Evaluation of Performance

The performance of a student will be evaluated in terms of three indices, viz., the Semester Grade Point Average (SGPA) which is the Grade Point Average for a semester, Cumulative Grade Point Average (CGPA) which is the Grade Point Average for all the completed semesters at any point in time, and Degree Grade Point Average (DGPA). Degree Grade Point Average (DGPA) is calculated on the basis of the best valid credits in each category, after graduation requirements in all categories are met.

The Earned Credits (E.C.) are defined as the sum of credits for courses in which a student has been awarded pass grades. Points secured in a semester = Σ (Course credits \times Grade point for all courses in which pass grade has been obtained). The SGPA is calculated on the basis of grades obtained in all courses the student registered for, in the particular semester, except audit courses.

$$\text{SGPA} = \frac{\text{Points secured in the semester}}{\text{Credits registered in the semester, excluding audit and S/Z grade courses}}$$

The CGPA is calculated on the basis of pass grades obtained in all completed semesters, except audit courses and courses in which S/Z grade is awarded.

$$\text{CGPA} = \frac{\text{Cumulative points secured in courses with pass grades}}{\text{Cumulative earned credits, excluding audit and S/Z grade courses}}$$

Examples of these calculations are given in Tables 4(a) and 4 (b).

Table 4: (a) Typical academic performance calculations - Semester I

Course no.	Course credits	Grade awarded	Earned credits	Grade points	Points secured
(column 1)	(column 2)	(column 3)	(column 4)	(column 5)	(column 6)
MTLXXX	5	C	5	6	30
COLXXX	4	C (-)	4	5	20
PYLXXX	4	A	4	10	40
PYPXXX	2	B	2	8	16
MCLXXX	4	E	0	2	08
TXNXXX	2	S	2	—	—

Credits registered in the semester (total of column 2) = 21

Credits registered in the semester excluding audit and S/Z grade courses = 19

Earned credits in the semester (total of column 4) = 17

Earned credits in the semester excluding audit and S/Z grade courses = 15

Points secured in the semester (total of column 6) = 114

Points secured in the semester in all passed courses (*total of column 6 and pass grade*) = 106

$$\text{SGPA} = \frac{\text{Points secured in the semester}}{\text{Credits registered in the semester, excluding audit and S/Z grade courses}} = \frac{114}{19} = 6.000$$

$$\text{CGPA} = \frac{\text{Cumulative points secured in courses with pass grades}}{\text{Cumulative earned credits, excluding audit and S/Z grade courses}} = \frac{106}{15} = 7.067$$

Semester performance: Earned credits (E.C.) = 17 SGPA = 6.000

Cumulative performance: Earned credits (E.C.) = 17 CGPA = 7.067

Table 4: (b) Typical academic performance calculations - semester II

Course no.	Course credits	Grade awarded	Earned credits	Grade points	Points secured
(column 1)	(column 2)	(column 3)	(column 4)	(column 5)	(column 6)
MTLXXX	5	B	5	8	40
ELLXXX	4	A (-)	4	9	36
CMLXXX	4	W	—	—	—
CMPXXX	2	B (-)	2	7	14
MCLXXX	4	C	4	6	24
APLXXX	4	A	4	10	40
NLNXXX	1	S	1	—	—

Credits registered in the semester (*total of column 2*) = 24

Credits registered in the semester excluding audit and S/Z grade courses = 23

Earned credits in the semester (*total of column 4*) = 20

Earned credits in the semester excluding audit & S/Z grade courses = 19

Points secured in this semester (*total of column 6*) = 154

Points secured in this semester in all passed courses (*total of column 6 & A-D grade*) = 154

Cumulative points secured = 106 (I semester) + 154 (this sem.) = 260

Cumulative earned credits = 17 (I semester) + 20 (this sem.) = 37

$$\text{SGPA} = \frac{\text{Points secured in the semester}}{\text{Credits registered in the semester, excluding audit and S/Z grade courses}} = \frac{154}{19} = 8.105$$

$$\text{CGPA} = \frac{\text{Cumulative points secured in courses with pass grades}}{\text{Cumulative earned credits, excluding audit and S/Z grade courses}} = \frac{106 + 154}{15 + 19} = 7.647$$

Semester performance: Earned credits (E.C.) = 20 SGPA = 8.105

Cumulative performance: Earned credits (E.C.) = 37 CGPA = 7.647

On completing all the degree requirements, the degree grade point average, DGPA, will be calculated and this value will be indicated on the degree/diploma. **The DGPA will be calculated on the basis of category-wise best valid credits required for graduation.**

A student, who has earned the requisite credits but does not meet the graduation DGPA requirement, may do additional courses in any elective category to meet the DGPA requirement within the maximum permissible time limit.

3. REGISTRATION AND ATTENDANCE

3.1 Registration

Registration is a very important procedural part of the academic system. The registration procedure ensures that the student's name is on the roll list of each course that he/she wants to study. **No credit is given if the student attends a course for which he/she has not registered.** Registration for courses to be taken in a particular semester will be done according to a specified schedule before the end of the previous semester. Each student is required to complete the registration process on the web-based system. The student must also take steps to pay his/her dues before the beginning of the semester. Students who do not make payments by a stipulated date can be de-registered for the particular semester.

As students have to report on the date prescribed by office of Dean Academics to mark his/her attendance in person, before the start of Semester. This is a requirement for validation of registration of existing students.

In-absentia registration or registration after the specified date will be allowed only in rare cases at the discretion of Dean, Academics. In case of illness or absence during registration, the student should intimate the same to his/her Programme Coordinator and Dean, Academics.

Brief description of registration related activities is given in the following paragraphs. The relevant dates are included in the Semester Schedule that is made available before the start of the semester. There may be changes in the schedule and/or procedure of registration from time to time. The students are intimated through e-mail about any such change to the e-mail address allocated to each student by the Institute at the time of admission. **This e-mail address is the only channel through which the Institute would communicate with the student. For cyber security reasons, e-mail accounts/kerberos logins that are not used for a certain length of time are disabled and such accounts locked/deleted by the Institute. Students must therefore login into their e-mail accounts/kerberos logins regularly.**

3.2 Registration and Student Status

Failure to register before the last date for late registration will imply that the student has discontinued studies and his/her name will be struck off the rolls.

All registered students, except part-time postgraduate students and casual students, are considered as full-time students at the Institute. They are expected to be present at the Institute and devote full time to academics and co-curricular and extra-curricular activities in the campus.

3.3 Advice on Courses

At the time of registration, each student must finalize the academic programme, keeping in view factors such as, minimum/maximum numbers of total and lecture credits, past performance, backlog of courses, SGPA/CGPA, pre-requisite(s), work-load and student's interests, amongst others. Special provisions exist for advising academically weak students. Details are given in section 4.7.

3.4 Validation of Registration

Before the commencement of classes of each semester, on a date specified in the Semester Schedule, every student including part-time students, is required to be present on campus and validate his/her registration by logging into the website. Students who do not do registration validation will not be permitted to add/drop courses.

3.5 Minimum Student Registration in a Course

Undergraduate courses (of 100, 200, 300, or 400 level) and M.Sc. courses (500 or 600 level) will run if a minimum of 12 students register for the course. Under special circumstances, a departmental elective course may be allowed to run with minimum registration of 8 students, with prior permission of Chairman, Senate. A 700 or 800 level course can run with a minimum of 4 students. This requirement will be verified on the last date for Add/Drop. Courses without the minimum enrolment will be dropped. The students who had registered for these courses will be de-registered, and they will be given one more day for adding a course in lieu of the dropped course.

3.6 Late Registration

For reasons beyond his/her control, if a student is not able to register or send an authorized representative with a medical certificate, he/she may apply to the Dean, Academics for late registration. Dean, Academics will consider and may approve late registration in genuine cases on payment of an extra fee called late registration fee. Late registration is permitted until a date specified in the Semester Schedule, typically one week after the beginning of the semester.

3.7 Add/Drop, Audit and Withdrawal of Courses

- a) **Add/Drop:** A student has the option to add courses that he/she has not registered for or drop courses for which he/she has already registered for. This facility is restricted to a period stipulated in the Semester Schedule, during the first week of the semester, subject to vacancy status of the courses concerned.
- b) **Audit:** A student may apply for changing a credit course to an audit course before a deadline specified in the Semester Schedule.

- c) **Withdrawal:** A student who wants to withdraw from a course should apply before a deadline specified in the Semester Schedule. A withdrawal grade (W) will be awarded in such cases.

Appropriate web-based applications are to be used for availing of the above-mentioned options.

3.8 Semester Withdrawal

Semester withdrawal and absence for a semester under different conditions, *viz.* (i) medical and personal grounds (ii) industrial internship (iii) exchange/deputation to another academic institution in India or abroad, and (iv) disciplinary condition can be granted on application. The condition as per the following should be clearly specified in the application.

- Semester Withdrawal (SW) reflects the condition, in which a student is forced to withdraw from all courses in the semester for medical conditions, or for a part-time student when he/she is sent for an outstation assignment by his/her employer. A student can apply for semester withdrawal if he/she has missed 20 or more teaching days on these grounds. Under no circumstances will an application for semester withdrawal be accepted after the commencement of major tests. A student is not permitted to request for semester withdrawal with retrospective effect.
- Semester Leave (SL) indicates the situation in which a student is permitted to take one or more semesters off for industrial internship or any other assignment with prior approval and planning. The application is to be routed through his/her advisor/programme coordinator and Head of the concerned Department/Centre/School. Dean, Academics is the final approving authority for such requests. All such applications must be processed before the beginning of the semester in which the leave will be taken. At present, JEE-entry B.Tech. and dual degree students are allowed one extra semester for completion of the programme for every semester leave for industrial internship. Such students are permitted a maximum of two semesters of leave. The full-time 2 year M.Tech./M.S.(R) students would be permitted a maximum of one semester leave for industrial internship or other assignment as approved by the Dean. These semesters will not be counted towards the maximum permitted time period for completion of the degree similar to the provision for JEE entry students.
- When a student registers at another academic institution in India or abroad with the expectation of credit transfer or research work through a pre-approved arrangement including an MoU, the student should be considered as being on a Semester Exchange (SE). The SE period will be counted towards the total period permitted for the degree.
- When a student is suspended for one or more semesters on disciplinary grounds, the student status should be called Disciplinary Withdrawal period (DW).
- UG student may go for a long Internship or spend a semester on a Technical Start-up with the prior approval of the DPE Committee of the Department.

3.9 Registration in Special Module Courses

Special module courses, i.e. 'V'-category courses, are 1 or 2 credit courses that can be offered at the beginning of the semester and the regular registration procedure will be followed. A 'V'-category course may also be offered during the semester. In such a case, students will be allowed to add this course before classes for the course begin. These courses will usually cover specialized topics that are not generally available in the regular courses. Eligible students can register for these courses. The course coordinator will evaluate the students' performance and award a letter grade. The credits so earned will count towards the appropriate category for degree completion purposes.

3.10 Registration for Non-graded Units

Details pertaining to registration and other modalities of earning non-graded units are given in Section 8 of this booklet.

3.11 Pre-requisite Requirement(s) for Registration

A student can register for a course only if he/she fulfills the pre-requisite requirement(s). Request for relaxation of pre-requisite requirement(s) may be raised by students under special circumstances. Such a request needs approval of the Departmental Faculty Advisor and Chairman Grades and Registration.

3.12 Overlapping/Equivalent Courses

A student is not allowed to earn credits from two overlapping/equivalent courses. Overlapping/equivalent courses, wherever applicable, are specified in the Description of Course Contents.

3.13 Limits on Registration

An undergraduate student (B.Tech. or Dual Degree) should register for a minimum of 12 credits in a semester. The maximum number of credits permitted for a UG student in a semester is 26, with a provision to register for up to 28 credits in a maximum of two semesters during the entire period of their study. This number would be reduced to a maximum of 1.25 times the average credits earned by the student in the past two registered semesters, in case the student is placed on probation on the basis of academic performance.

3.14 Registration and Fee Payment

Every registered student must pay the stipulated fees in full before the specified deadlines. In the event that a student does not make these payments, he/she can be de-registered from all courses and his/her name can be struck off from the rolls.

3.15 Continuous Absence and Registration Status

If a student is absent from the Institute for more than four weeks without notifying the Head of Department/Centre/School or Dean, Academics, his/her registration will be terminated and name will be removed from the Institute rolls.

3.16 Attendance Rule

It is mandatory for the students to attend all classes. Attendance Records of all students for each course will be maintained.

The Course Coordinator will announce the class policy on attendance with respect to grading etc., at the beginning of the semester. This shall be done keeping in mind the importance of classroom learning in the teaching-learning process. Once the class attendance policy has been made clear to all the students registered for the course, the Course Coordinator will implement the same in totality.

For the purpose of attendance calculation, every scheduled practical class will count as one unit irrespective of the number of contact hours.

Attendance record will be maintained based upon roll calls (or any equivalent operation) in every scheduled lecture, tutorial and practical class. Students are required to strictly adhere to and comply with any method or device employed by the Course Coordinator/Instructor for purpose of Attendance Recording. Failure to do so may call for disciplinary action. The course coordinator will maintain and consolidate attendance record for the course (lectures, tutorials and practicals together, as applicable).

A Course Coordinator may choose any one or more of the following as attendance policy.

- (a) The Course Coordinator can assign 10% of the total marks to surprise quiz(zes). If attendance of the student is greater than 90%, result of the best three quizzes will be considered, else average of all quizzes will be considered.
- (b) The Course Coordinator can allocate specific marks for participation in discussions in the class on a regular basis.
- (c) If a student's attendance is less than 75%, the student will be awarded one grade less than the actual grade that he/she has earned. For example, a student who has got an A grade but has attendance less than 75% will be awarded an A (-) grade.
- (d) A student cannot get NP for an audit course if his/her attendance is less than 75%.

The Course Coordinator can implement any other attendance policy provided the policy is approved by the Dean, Academics.

Attendance statistics will also be used in the following way:

- (a) If a student's attendance is less than 75% in more than two courses without any valid reason in a semester, he/she will be issued warning and put under probation. If this is repeated, he/she will not be allotted a hostel seat in the next semester.
- (b) If a student's attendance is less than 75% in any course or CGPA is less than 7.0, then he/she will not be eligible to hold any position of responsibility in the hostel/institute in the next semester.

4. UNDERGRADUATE DEGREE REQUIREMENTS, REGULATIONS AND PROCEDURES

4.1 Overall Requirements

4.1.1 B.Tech.

The total credit requirement for the B.Tech. (4-year programme) is 148-158 credits (exact requirement is discipline specific). The minimum and maximum number of registered semesters for graduation requirements are listed in Table 7. For B.Tech. programmes, the total credits are distributed over following categories :

- (a) Institute Core (IC):
 - Basic Sciences (BS): Mathematics, Physics, Chemistry and Biology courses
 - Engineering Arts and Science (EAS): Fundamental engineering courses
 - Humanities and Social Sciences (HUSS): At least two courses to be taken in the 200 level and at least one course to be taken in the 300 level. Management Courses (MSL 3XX) are not counted under this category.
- (b) Departmental Core (DC): courses of relevant discipline.
- (c) Departmental Electives (DE): electives related to the parent discipline.
- (d) Programme linked basic sciences/EAS (PL): additional BS/EAS courses that are specified by the department.
- (e) Open Category (OC): electives can be taken outside or within the discipline; these credits can be used towards departmental specialization or minor area also (see Sec 4.6).
- (f) Non-graded Core (NG) units: These are core requirements and can be earned through formal academic activity and informal co-curricular or extra-curricular activities.

4.1.2 Dual degree programmes

The total credit requirements for a dual degree programme would depend upon the credit requirements of the B.Tech. and M.Tech. programmes that constitute the Dual Degree. The minimum credit requirement for the award of Dual Degree would typically be 10 less than the total credits of the constituent B.Tech. and M.Tech. programmes. The B.Tech. requirements for a dual degree are same as that given in Section 4.1.1. The M.Tech. part is divided into two categories – Programme Core (PC) and Programme Elective (PE). The minimum and maximum number of registered semesters for graduation requirements are listed in Table 7.

4.2 Breakup of Degree Requirements

4.2.1 Earned Credit Requirements

The minimum earned credit/unit requirements for B.Tech. degree are given in Table 5.

Table 5 : Degree requirements of B.Tech. programmes

	Category	Symbol	B. Tech. Requirements	Remarks
1	Institute Core	IC	58 Credits	Common to all disciplines
2	Programme Linked EAS/BS	PL	0-15 Credits	Discipline specific as decided by the Department
3	Departmental core	DC	65-80 with min 10 as DE	Discipline specific
4	Departmental Elective	DE		
5	Open Category	OC	10 Credits	Open to student's choice
6	Non-graded Core	NG	11 units	See Sec. 4.3
	Total		148-158 Credits +11 nongraded units	

4.2.2 Degree Grade Point Average (DGPA) Requirement

A student must obtain a minimum DGPA of 5.0 to be eligible for award of the B.Tech. degree. The minimum DGPA requirement for M.Tech. part of Dual Degree programme is 6.0. All exceptions to the above conditions will be dealt with as per following regulations:

- (a) If a student completes required credits for B.Tech. with DGPA less than 5.0, then the student will be permitted to do additional elective courses under appropriate category to improve the DGPA within the maximum time limit for completion of B.Tech. degree. In case a DGPA of 5.0 or more is achieved within the stipulated period, a B.Tech. degree will be awarded and in case the same is not achieved no degree will be awarded and the student may apply for a diploma.
- (b) If a student completes requisite credits for Dual Degree Programme:
- (i) with B. Tech. DGPA less than 5.0 but M.Tech. DGPA more than 6.0
- The student will be permitted to do additional elective courses (under appropriate category) to improve the DGPA for completion of B.Tech. part within the maximum time limit. In case a DGPA of 5.0 or more is achieved for B.Tech., the student will become eligible for award of the Dual Degree (B.Tech. & M. Tech.) and in case the same is not achieved no degree will be awarded and the student may apply for a diploma.
- (ii) with B.Tech. DGPA more than 5.0 but M.Tech. DGPA less than 6.0
- The student may opt to do additional elective courses (PE category only) to improve the DGPA within the maximum time limit. If no programme elective (PE) courses are available, other relevant 700 and 800 level courses as approved by the department can be done for the purpose of improving the DGPA. In case DGPA of 6.0 or more is achieved for the M.Tech. part, the student will be eligible for award of the Dual Degree (B.Tech. & M.Tech.). However, in case the same is not achieved at the end of the stipulated period, the student will be eligible for the award of only B.Tech. degree, provided a written request for the same is made to the Dean, Academics.
- (iii) with B.Tech. DGPA less than 5.0 and M.Tech. DGPA less than 6.0
- The student will be permitted to do additional elective courses under appropriate categories to improve the DGPA for completion of B.Tech. and courses under PE category for completion of M.Tech. degree within the maximum time limit. If no programme elective courses are available, relevant 700 and 800 level courses as approved by the department can be done for the purpose of improving the DGPA of the M.Tech. part. In case a DGPA of 5.0 or more for B.Tech. and 6.0 or more for M. Tech. are achieved, the student will be eligible for award of the Dual Degree (B.Tech. & M.Tech.). However, in case a DGPA 5.0 or more for B.Tech. is achieved but the DGPA of 6.0 or more for M.Tech. is not achieved at the end of stipulated period, the student will be eligible for award of only B.Tech. degree provided a written request for the same is made to the Dean, Academics.
- (c) A student may be permitted to do additional elective courses under appropriate elective categories for improving DGPA, even if he/she satisfies all graduation requirements. The student may be permitted to register for courses in the additional semesters, up to the maximum limit in terms of registered semesters for improving his/her DGPA provided a request for the same is made to the Dean, Academics within 15 days of the notification of grades in the final semester. During this period when the student is registered for improving DGPA, no hostel facilities or assistantship will be provided to the student.
- (d) A student is eligible to apply for a Diploma provided he/she has earned 100 credits and has exhausted the maximum number of permitted registered semesters for completion of his/her degree. If the student has completed 50 credits (out of 100 credits) from his/her DC+DE+PC+PE categories then the student will be awarded 'Undergraduate Diploma in the respective discipline' on completion. If the student has not completed 50 credits from these categories but has completed 100 credits then he/she will be awarded 'Undergraduate Diploma in Engineering'. The Diploma is not equivalent to an undergraduate degree.
- (e) No self-study course will be permitted for the purpose of improvement of DGPA.

4.2.3 Audit Courses

Audit facility is open to all undergraduate students who have 85 Earned Credits. A student will be permitted to do any number of audit courses over and above the graduation requirements. The audit limits for graduation are:

- (a) B.Tech. (4-year) programme: A maximum of 8 credits from the elective courses in any category out of the total credits required for B.Tech. degree may be completed on audit basis.
- (b) Dual-degree programme: A maximum of 8 credits from the elective courses in any category may be completed on audit basis from the UG part of the programme.

- (c) A student earns either an NP (audit pass) or an NF (audit fail) grade for an audit course. The audit pass (NP) grade may be awarded if the student satisfies the attendance criteria specified for the course and he/she has obtained at least a 'D' grade. The course coordinator can specify a higher criterion for audit pass at the beginning of the semester. If either of these requirements is not fulfilled, the audit fail (NF) grade is awarded.
- (d) Grades obtained in an audit course are not considered in the calculation of SGPA or CGPA.

4.3 Non-graded Core Requirement

As part of the curriculum, non-graded units have been prescribed as core requirements for the undergraduate degree. These units can be earned through a combination of formal academic activities and informal co-curricular or extra-curricular activities. The components of non-graded core requirement are listed in Table 6.

Table 6: Components of Non-Graded Core Requirement

	Components	Minimum NGUs for Graduation	Maximum Countable Towards Total of 11 NGUs
1	Introduction to Engineering and Programme	1	1
2	Language and Writing Skills	2	2
3	Communication Skills/Seminar	1	1
4	NCC/NSO/NSS	1	2
5	Professional Ethics and Social Responsibility	1	2
6	Design and Practical Experience	3	5
	Total units required for graduating		11

The 11 units listed in Table 6 will be core requirement for students of all undergraduate programmes with entry year 2020 or later. A student must earn these 11 units over the complete duration of the programme with special requirements for each component as explained in Chapter 9. A student must get S grades to earn these units. Incomplete performance in these components will be indicated by a Z grade.

For components 3-6 in the above table, a special portal called the NGU portal is used for necessary approvals and posting of "S" grades. This portal can be accessed at <https://ngu.iitd.ac.in/index>

A brief description of the six components is given below. For complete details, please refer to Chapter 9.

(a) Introduction to Engineering and Programme (NIN100) (1 unit)

This course will introduce the students to the vast domain of Engineering in general with a glimpse of the specifics of various engineering disciplines. All students will be required to register for this course in the first semester for earning 1 unit. These may involve listening to guest lectures, interaction with distinguished alumni, simple product building and product dissection exercises, executing simple design thinking exercises, visit to laboratories (in and outside the Institute) and industry.

(b) Language and Writing Skills (NLN100 and NLN101) (2 units)

All students will be required to participate in Task-Based Language Learning (TBLL) exercises in the first year, through two core courses: NLN100 in first semester and NLN101 in second semester. These language games are designed to enhance their linguistic capabilities in comprehension, both reading and listening, as well as improve their ability to structure and compose ideas in spoken and written communication. Wherever necessary principles of English Grammar will be discussed along with the nuances of technical writing. The Language Needs of a particular class of students will be assessed through an initial language test at the beginning of the first semester. Then, the exercises will be tailored according to the specific language needs of the particular class of students. These exercises could be scheduled during normal academic hours or outside. Based on the performance and regularity, a student may be prescribed additional self-learning exercises and practice sessions during vacations as well, as requirement for securing an S grade.

(c) NCC/NSO/NSS (NCN100/NSN100/NPN100) (Minimum 1 and Maximum 2 units)

NCC/NSO/NSS also form part of the core requirement of the degree. Students will be required to earn at least 1 unit from these activities involving 40 hours of work and a maximum of 2 units for 80 hours of work towards the total NGU requirement.

(d) Professional Ethics and Social Responsibility (PESR) (Minimum 1 and Maximum 2 units)

There is increasing consensus worldwide that professional ethics need to be incorporated into the engineering curriculum to provide students exposure to the kind of professional and ethical dilemmas they might face on an individual basis as well as the larger ethical aspects of technology development. Workshops, discussions/debates will be organized to sensitize students about Professional Ethics and Social Responsibility (PESR). This component has 3 core courses: NEN100 in first semester, NEN101 in 2nd semester and NEN300 after 3rd year corresponding to a total of 1 unit. Students can earn an extra unit through additional activities, such as PESR workshops (NEN202) and PESR projects (NEN203). For more details, please see Section 9.4.

(e) Skills/Seminar (1 unit)

Communication skills is an essential requirement for a modern engineer. As a part of the degree requirements, undergraduate students will have to earn 1 unit in communication skills by registering for a seminar course or an equivalent activity. Please see Section 9.5 for details.

(f) Design and Practical Experience (Minimum 3 and Maximum 5 units)

The objective of this non-graded core requirement component is to give opportunities to students to acquire substantial design and practical experience both as a part of formal courses as well as in an informal setting. Second and even more important objective of this course is to inculcate design thinking among students and facilitate gaining some design immersion experience. Design and Practical Experience (DPE) component is introduced to promote learning by doing which does two important things: it allows students to immerse themselves in the environment in which work is to be done, so that they can understand the values and expectations of the target beneficiaries. Secondly, it enables a fresh look at problems, not only at the ways of defining them, but also at the ways to solve those including skill-sets that are required to address them. A shift from problem-based learning (acquisition of knowledge) to project-based learning (application of knowledge), where the projects are grounded in problems outside the classrooms and labs in everyday scenarios, will involve students in reality, and reality in education. Design and Practical Experience bridges division between the curricular and the co-curricular and encourages curiosity and involvement that arise out of total absorption in a subject of interest. Non-graded units in Design and Practical Experience can be earned through one or more of the following:

- Specialized Elective Courses related to Design and Practical Experience (Maximum 2 Units)
- Regular Courses with optional Design and Practical Experience Component (Maximum 2 Units)
- Summer/winter/semester/SURA/DISA projects with Institute faculty, not evaluated for earning credits (Maximum 2 units)
- Co-curricular projects such as Robocon, SAE-minibaja, etc. (Maximum 2 Units)
- Summer Internships with Industry (Maximum 2 Units)
- One Semester Internship (Maximum 5 Units)
- Workshop Module on Design and Practical Experience offered by Faculty/Visitors (1 Unit each)
- Section 9.6 gives complete details for this component.

4.4 Minimum and Maximum durations for completing degree requirements

(a) The minimum and maximum permitted duration of each academic programme will be determined in terms of number of registered regular semesters, hereinafter called registered semesters. Any semester in which a student has registered for a course will be called a registered semester subject to the following:

- (i) Only the First and Second semesters of an academic year can be registered semesters. The summer semester will not be counted as a registered semester.
- (ii) A semester when a student has been granted semester withdrawal or granted semester leave will not be considered as a registered semester.

- (iii) The semester when a student is suspended from the Institute on disciplinary grounds will not be counted towards the number of registered semesters.
- (iv) A semester in which a student is allowed by the Institute to undergo semester - long internship will be counted as a registered semester.

The summer semesters shall normally be available for earning credits. However, after the student has registered for the maximum permissible number of registered semesters, the subsequent summer semesters will not be available for earning credits.

- (b) The minimum and maximum permissible number of registered semesters for completing all degree requirements are defined in Table 7.

Table 7: Minimum and Maximum permissible duration for completing degree requirements.

Programme Name	Minimum Number of Registered Semesters	Maximum Number of Registered Semesters Permitted for Completing Degree Requirements
B.Tech.	8	12*
Dual Degree	10	14*

*If a student opts for the slow-paced programme, then the maximum permissible number of registered semesters shall be increased by two semesters.

4.5 Absence During the Semester

- (a) A student must inform the Dean, Academics immediately of any instance of continuous absence from classes.
- (b) A student who is absent due to illness or any other emergency, up to a maximum of two weeks, should approach the course coordinator for make-up quizzes, assignments and laboratory work.
- (c) A student who has been absent from a minor test due to illness should approach the course coordinator for a make-up test immediately on return to class. The request should be supported with a medical certificate from Institute's medical officer. A certificate from a registered medical practitioner will also be acceptable for a student normally residing off-campus provided registration number of the medical practitioner appears explicitly on the certificate.
- (d) In case a student misses a minor test on the same day on which he/she has appeared in another test, a medical certificate from the institute's medical must be submitted.
- (e) In case of absence on medical grounds or other special circumstances, before or during the major examination period, the student can apply for 'I' grade. At least 75% attendance in a course is necessary for being eligible for request of I-grade in that course. An application requesting I-grade should be made at the earliest but not later than the last day of major tests. An online application should be made by the student. On submission of a medical certificate/Dean's permission, the UG section verifies the certificate and forwards the request to the concerned course coordinator. The course coordinator verifies the attendance requirement and forwards the application to the Head of the Department/Centre/School of the student's programme. Head's approval is contingent upon the satisfaction of attendance requirement. On approval, an 'I' grade is awarded to the student. All evaluation requirements for students with 'I' grade should be completed before the end of the first week of the next semester. Upon completion of all course requirements, the 'I' grade is converted to a regular grade (A to F, NP or NF).
- (f) In case the period of absence on medical grounds is more than 20 working days during the semester, a student may apply for withdrawal from the semester, i.e. withdrawal from all courses registered that semester. Such application must be made as early as possible and latest before the start of the major tests. No applications for semester withdrawal will be considered after the major tests have commenced. Dean, Academics, depending on the merit of the case, will approve such applications. Partial withdrawal from courses registered in a semester is not allowed.
- (g) If a student is continuously absent from the institute for more than four weeks without notifying the Dean Academics, his/her name will be removed from institute rolls.

4.6 Conditions for Continuation of Registration, Termination/Re-start, Probation and Warning

During the first two registered semesters of an undergraduate programme, a student is registered for a total of 34 credits, besides non-graded units. By the end of the first two registered semesters, not including summer, a student is expected to earn a minimum number of credits (excluding non-graded units) as specified in Table 8, in order to continue registration. If a student does not meet this criterion, his/her performance is classified as “Poor Performance”, and he/she may opt to start the programme afresh, or else his/her registration will be terminated. This option to re-start the programme is available to a student only once.

Table 8: Criteria for continuation at the end of second registered semester

Description	Earned Credits (excluding non-graded units)		Decision
	GE/OBC/EWS	SC/ST/PD	
Minimum for Continuation	23	19	Continuation of registration
Poor Performance	≤ 22	≤ 18	Restart (Once only)/Termination of registration

- If a student chooses to restart after the first two registered semesters, then his/her credits earned and semesters registered will not be carried over. The re-start will be indicated on the transcript. The re-start will be permitted only once. If at the end of two registered semesters after re-start, the earned credits are less than or equal to 22 for GE/OBC or less than or equal to 18 for SC/ST/PD students, then the registration will be terminated.
- Each student is expected to earn at least 12 credits in each registered semester with an SGPA greater than or equal to 5.0. If the performance of a student at the end of any registered semester is below this minimum acceptable level, then he/she will be placed on probation, a warning shall be given to him/her and intimation sent to the parents.
- A student placed on probation shall be monitored, including mandatory attendance in classes, special tutorials and mentoring. Mentoring would comprise structured guidance under a senior/postgraduate student.
- If the performance of a student on probation does not meet the criterion in item (b) in the following registered semester, then the student would face termination, and will be permitted to register by the Dean, Academics only if the department makes a favourable recommendation. The Head of the Department's recommendation shall be prepared after consultation with the student, and should include (i) feasibility of completing the programme requirements, and (ii) identification of remedial measures for the problems leading to poor performance.
- A student on probation can register upto 18 credits in a semester. This can be relaxed in 8th/10th or later registered semester for B.Tech./Dual Degree students, respectively.

Slow-paced programme

- If a student has earned the minimum credits specified in Table 8 for continuation but has less than 28 Earned Credits at the end of the first two registered semesters, he/ she will be eligible to opt for the slow-paced programme. A student opting for such a programme shall be permitted two additional registered semesters for completing degree requirements as indicated in Table 7.
- In the slow paced programme, the upper limit for credits registered in a semester will be 18. A student in this programme is expected to earn at least 9 credits with minimum SGPA of 5.0 in any semester, falling which he/ she will be issued a warning and placed on probation.

A student placed on probation would be monitored, including mandatory attendance in special tutorials and mentoring.

If the performance of a student on probation does not meet the above criterion in the following registered semester, then the student would face termination and will be permitted to register by the Dean Academics only if the department makes a favourable recommendation. The Head of the Department's recommendation

shall be prepared after consultation with the student, and should include (i) feasibility of completing the programme, and (ii) identification of remedial measures for the problems leading to poor performance.

- (c) The semester-wise schedule of the slow-paced programme shall be defined by the respective department for each student.

4.7 Scheme for Academic Advising of Undergraduate Students

Advising Scheme for Regular Students

- (a) There is a class committee for each entry year of all programmes. The class committee is responsible for providing consistent and uniform academic advice to the entire batch of students.
- (b) Class committee shall consist of a Chairman, at least two faculty members of the department (one of them will function as Convenor of the class committee) and elected student representatives (as per CAIC constitution) including a student coordinator. All student coordinators of courses intended for the batch in a given semester and special advisors of academically weak students will be permanent invitees to the class committee. The faculty members in the class committee would be referred to as Faculty Mentors for the batch.
- (c) A Chairperson appointed for each entry year of students by the Head of the Department shall be associated with the batch till it graduates and will provide basic guidance for formulating course plan and electives for the students of the batch.
- (d) The Convenor of a class committee will be appointed in a year-specific fashion: for example, the Convenor of the second year class committee would continue in the same position for 3 years, serving consecutive batches.
- (e) Students can approach any class committee member for academic advice before registration. In other words, all the three members of the class committee will have the functional role of mentor and local guardian for all the students. In case of need for any exception and relaxation in rules or regulations pertaining to registration of courses, the class committee Convenor will recommend and forward the request.
- (f) The faculty members of the committee in consultation with the elected representatives of the students will provide academic advice applicable to all the students in general. The class committee is also expected to discharge following responsibilities:
- (i) Considering mid-semester feed-back about courses running in the current semester
 - (ii) Identifying electives for the subsequent semester
 - (iii) Addressing issues related to scheduling and categorisation of courses
 - (iv) Organizing STIC events for the batch.
- (g) The Class Committee Convenor with the support of student coordinator will organize at least one Student-Teacher Interaction Committee (STIC) event in each semester for interaction between class committee members and all the students of the batch.
- (h) The Chairman, Convenor and the other faculty members of first year class committee would be identified by the department prior to the orientation of new students. During orientation, students and their parents will be introduced to these class committee members.

Advising Scheme for Academically Weak Students

- (a) The students on probation in each batch will be put under a special advisor, identified by the department, who is expected to monitor the students on probation in a personalized manner. Normally, not more than 5-8 students would be assigned to a special advisor. Heads of Departments will appoint special advisors at the beginning of an academic session.
- (b) A meeting of the special advisors with Dean, Academics would be held at the beginning of each semester for coordination of the advising process.
- (c) A student on probation is expected to be in close contact with the advisor by meeting him/her at least once every 3 weeks for the entire period during which the student continues to remain in probation. Special advisors will be invitees to the class committee meetings.
- (d) Special advisor in consultation with the parents and student counsellor, if required, will make a student-specific academic plan. The special advisor is expected to:

- Closely interact with the weak student and his/her parents
 - Formulate individualized academic plan
 - Manage and track counselling process of the student, if any, in coordination with the Associate Dean, Student Welfare.
 - Approve their registration
 - Manage the recommendation/appeal for termination/continuation process in consultation with Head of the Department and Dean, Academics.
- (e) At the time of registration for a semester, the student meets his/her advisor if possible with parents, to:
- Identify specific problems and ways to mitigate the same
 - Formulate academic plan and target(s) for the semester
 - Help Head of the Department in the processing of the student's appeal against termination, if applicable
 - Approve the registration of the student online.
- (f) The student being placed under probation for the first time may also meet the counsellor during this period, if needed. The counsellor can provide professional help in identifying to resolving problems. Counsellors' input will be available to the special advisor. During the add-drop period, the student, preferably along with his/her parents, should come and meet the Counsellor.
- (g) While considering any appeal from an academically weak student for continuation of his registration, the Dean, Academics would consider the following:
- (i) whether he/she has met his/her Advisor and Counsellor at the scheduled times on a regular basis and
 - (ii) whether he/she is regular in help sessions.
- Registration of a student under probation will not be approved for the next semester if he/she does not comply with the process of meeting the advisor and counsellor. He/ she will then be required to withdraw from the semester.
- (h) A student on probation will not be permitted to contest for any position of responsibility. However, he/ she will be permitted to participate in extra-curricular activities in a restricted fashion only on specific recommendation of his/her advisor.

An Institute level committee known as the Welfare Committee would monitor the entire operation of academic advising for weak students. Functions of the Welfare committee include monitoring the performance of weak students and making the final recommendations regarding termination/ continuation, restarting first year and slow-paced programme requests. This committee would also evaluate the weak students based on the feed-back regarding

- (i) regularity in meeting the advisor and /or counsellor
- (ii) student's attendance in help sessions and
- (iii) academic performance.

A summary of the weak student's performance would be made available to the class committee members, Head of the student's Department as well as Course Coordinators of the courses in which the student is currently registered.

Student Mentors

- (a) Each student will be assigned a student mentor from the same hostel and preferably from the same discipline to mentor students on academic and extra-curricular activities and provide feed-back to the advisor and counselor in case of weak students.
- (b) There are individual incentives for good student mentors. Also, hostels performing well on mentoring benefit in terms of points towards BSW trophy.

4.8 Capability Linked Opportunities for Undergraduate Students

A student who clears all the first year credit requirements with CGPA 7.0 and above will be permitted to register for additional credits from third semester onwards. A student will be permitted to register for up to 26 credits per semester provided

- (a) The student has cleared all courses for which the student has registered till then and
- (b) His/her CGPA is 7 or above

In case a student does not meet this requirement but has cleared $20 \times N$ credits, where N is the total number of semesters spent, then he/she can register up to a maximum of 24 credits.

A student registering for 26 credits in each semester after the end of first year can complete a maximum of 190 credits at the end of 4 years. Similarly, a student registering for 24 credits in each semester after first year can complete a maximum of 178 credits. Since the graduation requirement for 4-year B.Tech programmes varies between 145-155 Earned Credits, it will be feasible for capable students to add value to their degrees by registering for additional courses of their choice.

Students can make use of these additional credits in two blocks of 20 credits to opt for:

- (a) Minor/Interdisciplinary Area Specialization
- (b) Departmental Specialization

A student based on his/her performance and interest can choose either one or both. Successful completion of minor area credits and/or departmental Specialization will be indicated on the degree.

When a student opts for a departmental specialization and/or a minor area, he/she can use 10 open category credits (mandatory degree requirement) towards departmental specialization and/or minor area requirements. For example, a student registered for B.Tech (Chemical Engineering) and opting for minor area in Computer Science and Engg., can opt for courses prescribed for minor area in Computer Science and Engineering, as part of mandatory 10 credits requirements under OC. He/she will need to do additional 10 credits in the minor area to be eligible for Minor area specialization in the degree.

A student may not opt for either of the two but can do additional credits through open choice of courses. In case a student cannot meet requirements of a minor area or departmental Specialization, additional credits earned by the student over and above his/her degree requirement will be used for DGPA calculation and will be indicated on his/her transcript.

A set of pre-defined courses of total 20 credits in a focus area comprises a Departmental Specialization if the courses belong to the parent Department of an undergraduate programme, or a Minor/Interdisciplinary Area Specialization if the courses belong to a different Department/Centre/School. Additional conditions and details of individual specializations are given in Section 7.

If any course of a Minor/Interdisciplinary area overlaps with any core course (DC or PC category courses) or elective course (DE or PE category courses) of the student's programme, then credits from this course will not count towards the minor area credit requirements, though this course may contribute towards satisfying the requirement of the Minor/Interdisciplinary area. In such a case, the requirement of 20 credits must be completed by taking other courses of the specialization.

4.9 Change of Programme at the End of the First Year

- (a) An undergraduate student is eligible to apply for change of branch at the end of the first year only, provided he/she satisfies the following criteria:
 - (i) CGPA for General and OBC category students : >8.00
 - (ii) CGPA for SC/ST and Person with Disability category students : >7.00
 - (iii) Earned credits/non-graded units at the end of the second semester of the first year : All credits of core and non-graded units of the first year
 - (iv) Optionally, one first year course would be identified by each programme, in which the grade of the applicant is equal to or above B. A list of such courses identified for various programmes is given in Table 9.
- (b) The student should have no disciplinary action against him/her.
- (c) Change of the branch will be permitted strictly in the order of merit, in each category, as determined by CGPA at the end of first year, subject to the limitation that the actual number of students in the third semester in the branch to which transfer is to be made should not exceed its sanctioned strength by more than 15% and the strength of the branch from which transfer is being sought does not fall below 85% of its sanctioned strength.
- (d) In case more than one student applying for programme change have the same CGPA, the tie shall be resolved on the basis of JEE ranks of such applicants.

- (e) The conditions mentioned in item (a) above will not be insisted upon for change to a branch in which a vacancy exists with reference to the sanctioned strengths, and the concerned student was eligible as per JEE Rank for admission to that branch at the time of entry to IIT Delhi. However, these conditions will continue to apply in case of students seeking change to a branch to which the concerned student was not eligible for admission at the time of entry to IIT Delhi.

Table 9: Qualifying criterion as per a (iv) for change of branch

S. No.	Programme Code and Name of the Programme to which change is sought		Specified Course in which a minimum of B grade is required
1	AM1	B.Tech. in Engg. and Computational Mechanics	APL100: Engineering Mechanics
2	BB1	B.Tech. in Biochemical Engg. and Biotechnology	CML101: Introduction to Chemistry
3	CH1	B.Tech in Chemical Engineering	MTL101: Linear Algebra and Differential Equations
4	CH7	B.Tech. and M.Tech in Chemical Engineering	MTL101: Linear Algebra and Differential Equations
5	CE1	B.Tech in Civil Engineering	APL100: Engineering Mechanics
6	CS1	B.Tech. in Computer Science and Engineering	COL100: Introduction to Computer Science
7	CS5	B.Tech. and M.Tech in Computer Science and Engg.	COL100: Introduction to Computer Science
8	EE1	B.Tech. in Electrical Engineering	None
9	EE3	B.Tech. in Electrical Engg. (Power and Automation)	None
10	ES1	B.Tech. in Energy Science & Engineering	To be decided
11	MS1	Materials Science and Engineering	APL100: Engineering Mechanics
12	MT1	B.Tech. in Mathematics and Computing	MTL100: Calculus
13	MT6	B.Tech. and M.Tech. in Mathematics and Computing	MTL100: Calculus
14	ME1	B.Tech. in Mechanical Engineering	None
15	ME2	B.Tech. in Production and Industrial Engineering	None
16	PH1	B.Tech. in Engineering Physics	PYL101: Electromagnetism & Quantum Mechanics
17	TT1	B.Tech. in Textile Technology	APL100: Engineering Mechanics

4.10 Self-study Course

A self-study course will be from the regular UG courses listed in this document (Section 10). The main features of a self-study course are as follows:

- (a) A student may be given a self-study course not exceeding 5 credits in the final semester if he/she is short by a maximum of 5 earned credits required for graduation and provided that the course is not running in that semester as a regular course. Students in the Dual-Degree programmes are allowed to avail of this provision during their last semester. However, they would be permitted to take only a UG course as a possible self-study course. A student can make use of this provision only once during the programme.
- (b) A student may also be permitted to do a U.G. core course not exceeding 5 credits in self-study mode at most once during the program, provided he/she has failed in it earlier and the course is not being offered as a regular course during that semester.

- (c) Students should apply for a self-study course with appropriate recommendation of a Course Coordinator and the Head of the Department of the student's programme. The final sanction of a self-study course to a student is made by the Dean, Academics.
- (d) Normally, no formal lectures will be held for a self-study course but laboratory, design and computation exercises will be conducted if they form an integral part of the course.
- (e) The Course Coordinator will hold minor and major tests besides other tests/quizzes for giving his/her assessment at the end of the semester. In summer semester, there will be at least one mid semester test and a major test.
- (f) The self-study course will run during the total duration of a given semester (Semester I, Semester II, or the summer semester).

4.11 Assistantship for Dual-Degree Programmes

The students of dual-degree programmes will be considered for award of institute research/ teaching assistantship if they have earned 135 credits. Only those students who have either qualified GATE or have a CGPA more than 8.0 will be eligible for this assistantship. The assistantship will be provided for a maximum period of 14 months beginning from the summer semester following eighth semester, provided the student is registered for M.Tech. Major Project in that semester. A student availing assistantship will be required to provide 8 hours of assistance per week besides his/ her normal academic work. For continuation of assistantship a student will need to secure SGPA of 7.0. A student will be eligible to receive assistantship from sources other than institute fund or MHRD if he/she has a CGPA of 7.0 and has earned 135 credits.

A student receiving assistantship will be eligible for total of 30 days leave during the 14-month period. He/she will not be entitled to mid-semester breaks, winter and summer vacations.

4.12 Admission of UG Students to PG Programmes

Undergraduate students of the Institute are eligible for admission to PG programmes at IIT Delhi. For admission to PG programme the minimum CGPA required at the end of sixth semester shall be 7.5. The student will be awarded both the degrees - B.Tech. and the PG degree on successful completion of the degree requirements of both the programmes with provision for waiver of a maximum of 10 credits.

4.13 Measures for helping SC/ST Students

A number of measures exist for helping students belonging to SC and ST categories. A senior faculty member is appointed as adviser to SC/ST students for advising them on academic and non-academic matters. Financial measures for helping SC/ST students are described in the Prospectus.

5. POSTGRADUATE DEGREE REQUIREMENTS, REGULATIONS AND PROCEDURES

5.1 Degree Requirements

The detailed degree requirements for M.Sc., M.B.A., M.Des. M.Tech., M.S. (Research), Ph.D. degrees and P.G. D.I.I.T. are listed in Table 10.

5.2 Continuation Requirements

The detailed requirements for continuation as a student in the respective programme for M.Sc., M.B.A., M.Des. M.Tech., M.S. (Research), M.P.P., Ph.D. degrees and P.G. D.I.I.T. are listed in Table 10. Failure to maintain the specified academic standing will result in termination of registration and the student's name will be struck off the rolls.

The maximum permitted duration of each programme will be determined in terms of the number of registered semesters. Any semester in which a student has registered for a course will be called a registered semester subject to the following:

- (a) Only the 1st and 2nd semesters of an academic year can be registered semesters. The summer semester will not be considered as a registered semester.
- (b) A semester when a student has been granted semester withdrawal or granted leave will not be considered as a registered semester.
- (c) The semester when a student is suspended from the Institute on disciplinary grounds will not be counted towards the number of registered semesters.

The summer semesters falling in between the permitted registered semesters shall be available for earning credits. After the student has registered for the maximum permissible number of registered semesters, the subsequent summer semesters will not be available for earning credits.

5.3 Minimum Student Registration for a Programme

M.Sc., M.B.A., M.Des., M.P.P. or M.Tech. programme will not be run unless the number of students registered for that programme is six or more. If the number of students left in a programme at the end of the 2nd semester is less than four, the same programme may be looked into for temporary suspension by the Board of Educational Research and Planning.

5.4 Lower and Upper Limits for Credits Registered

For students pursuing M.Sc., M.B.A., M.Tech., M.P.P. and M.S.(Research), the minimum registration requirements in a semester are specified in Table 10. These minimum credit requirements are not applicable for graduating students who require lower than the proposed minimum to graduate.

5.5 Audit Courses for PG Students

- (a) M.Tech./M.S.(R)/M.Sc./M.P.P./Ph.D. students are eligible for auditing a course at any time before completion of the programme.
- (b) A student can request for an audit grade in any course provided he/she is eligible to earn audit credits, he/she is already registered for that course and it is not a core requirement of the student's programme. The request for auditing a course should be made on or before the last date for audit requests as defined in the semester schedule.
- (c) A student earns either an NP (audit pass) or an NF (audit fail) grade for an audit course. The audit pass (NP) grade may be awarded if the student satisfies the attendance criteria specified for the course and he/she has obtained at least a 'D' grade. The course coordinator can specify a higher criterion for audit pass at the beginning of the semester. If either of these requirements is not fulfilled, the audit fail (NF) grade is awarded.
- (d) Grades obtained in an audit course are not considered in the calculation of SGPA or CGPA.
- (e) M.Tech., M.Sc., M.S.(R), M.P.P. and Ph.D. students can audit a course over and above their credit requirements, as specified by the supervisor and SRC. Audited credits do not count for graduation requirements of PG students.

- (f) Non-credit core courses or core courses not considered for calculation of SGPA or CGPA for PG programmes like Ph.D., MBA, M.Tech., M.P.P., M.S.(R) should not be referred to as audit courses. These courses should be treated like similar core requirements for UG programmes such as Introduction to Programme. A student can earn either a S or Z grade in such courses. The grade S indicates successful completion. A student has to earn a S grade in such a course to meet the core requirements of a programme.

5.6 Award of D.I.I.T. to M.Tech./MBA Students

If a student after completing the maximum period available for the M.Tech. programme is not able to get the required minimum DGPA of 6.0 with the minimum required credits for the respective programme, then he/she can apply for a D.I.I.T. irrespective of whether the department/centre runs a Diploma programme or not. For the award of D.I.I.T., the student must have earned a minimum of 36 valid credits with a minimum CGPA of 5.5. The request for the award of DIIT must be made within 5 years of the date of joining the programme.

In case of M.B.A., DIIT shall be considered if at least 36 credits (9 courses from core and 3 courses from focus module) +4 compulsory audit courses, have been completed satisfactorily with a minimum CGPA of 5.5.

5.7 Regulations for Part-time Students

Normally, part-time M.Tech. and M.S. (Research) students are expected to complete the degree requirements in six semesters. In case of special circumstances, including extension of project work, the student can be allowed to continue beyond six semesters but in any case he/she cannot extend registration beyond ten semesters excluding summer semesters. In case of full-time students converting to part-time registration, the limit of six semesters will continue to apply.

5.8 Leave Rules for P.G. D.I.I.T., M.Des., M.Tech. and M.S. (Research)

A full-time P.G. D.I.I.T., M.Des., M.Tech. or M.S. (Research) student during his/her stay at the Institute will be entitled to leave for 30 days (including leave on medical grounds), per academic year. Even during mid-semester breaks, and summer and winter vacations, he/she will have to explicitly apply for leave. He/she, however, may be permitted to avail of leave only up to 15 days during winter vacation at the end of the first semester.

The leave will be subject to approval of the Head of Department/Centre/Programme/School Coordinator concerned and a proper leave account of each student shall be maintained by the Department/Centre/Programme/School Coordinator concerned.

5.9 Assistantship Requirements

A P.G. D.I.I.T., M.Des., M.Tech. or M.S. (Research) student irrespective of the source of assistantship, must attend at least 75% of classes in each course in which he/she is registered. In case his/her attendance falls below 75% in any course during a month, he/she will not be paid assistantship for that month. Further, if his/her attendance again falls short of 75 % in any course in any subsequent month in that semester, his/her studentship and assistantship will be terminated. For the above purpose, if 75% works out to be a number which is not a whole number, the immediate lower whole number will be treated as the required 75% attendance.

The students are expected to put in 8 hours per week towards the work assigned by the Institute. Continuation of assistantship in a subsequent semester would be conditional to satisfactory performance of the assigned work and a SGPA of 7.0 or more (relaxed to 6.75 for SC/ST and PH students registered in M.Des., M.Tech. and M.S. (Research) programmes).

5.10 Summer Registration

Summer semester registration for PG students is admissible. M.Tech./M.S.(R)/M.Des./M.P.P. students will be allowed to register for maximum of one course (upto 4 Credits) and M.B.A./M.Sc. students upto 2 courses in the summer. Summer semester registration for PG students is permitted only when a student would graduate on completion of the courses registered in summer, and it is recommended by DRC/CRC. For projects, in case X grade is awarded in the second semester, the student would be expected to register during summer for completion of the project. Normally regular courses would not be offered during summer semester. Courses can, however, be offered by Departments/Centres/Schools for taking care of special situations subject to the availability and consent of faculty.

5.11 Master of Science (Research) Regulations

The M.S. (Research) programme will comprise of 15 credits of the course work and 36 credits of the research work. The 15 credits of course work should not include any component of minor project. In the first semester, the student has to register for a minimum of 09 and a maximum of 15 credits. In the first semester, the part-time students can only register for course work with minimum and maximum limits of 3 and 12 credits, respectively. The course work must be completed by the end of third semester; otherwise the registration of the student will stand cancelled.

The larger project component gives the student an opportunity to conduct in-depth investigation on a topic of his/her interest. The project will be monitored by the Student Research Committee (SRC) and the students will have to register for thesis (project course no. xxD895, 'xx' is department/school code) for 36 credits. An 'X' grade is awarded at the end of each semester until the project work gets completed and the thesis is written. Nominally the M.S.(R) programme is expected to take 4 semesters (excluding summer). Upon completion of project work, a thesis is written that is evaluated by one internal and one external examiner. Upon satisfactory recommendations from the examiners, the thesis defense can be conducted before a committee. Conversion to Ph.D. is also possible. For further details, see the "Rules and Regulations for Master of Science (Research) Programme" booklet.

5.12 Migration from one PG programme to another PG Programme of the Institute

Provision exists for the PG students of the Institute to move from (i) M.Tech./M.S.(R) to Ph.D., (ii) M.Tech. to M.S.(R), and (iii) M.S.(R) to M.Tech. as per details given in the table below:

	M.Tech./M.S.(R) to Ph.D.	M.Tech. to M.S.(R)	M.S.(R) to M.Tech.
Timing	> 1st Sem.	> 1st Sem. & ≤ 3rd Sem.	> 1st Sem. & ≤ 3rd Sem.
Eligibility	≥ 8.0 SGPA/CGPA & ≥ 12 credits	≥ 12 credits	≥ 12 credits
Admission	DRC/CRC (Evaluation)	DRC/CRC (Evaluation)	DRC/CRC (Evaluation)
Credits	Credits transfer as recommended by DRC/CRC	Credits transfer as recommended by DRC/CRC	Credits transfer as recommended by DRC/CRC
Duration	Max. 7 years from date of joining M.Tech./M.S.(R)	Max. 5 years from date of joining M.Tech.	Max. 5 years from date of joining M.S.(R)

Full-time M.Tech. and M.S.(R) students of IIT Delhi interested in joining the Ph.D. programme within two years of completion of their M.Tech./M.S.(R) will be granted waiver of residency period. The course work requirements can be made up by either additional credits (6 credits as per present norms) taken during their M.Tech./M.S.(R) period (over and above their minimum Degree requirements) or in the summer semester (first or second) by identifying courses. In all cases, the request for such credit transfer should be recommended by the concerned DRC/CRC/SRC as relevant to their respective Ph.D. programmes.

5.13 Doctor of Philosophy (Ph.D.) Regulations

The award of Ph.D. degree is in recognition of high achievements, independent research and application of scientific knowledge to the solution of technical and scientific problems. Creative and productive enquiry is the basic concept underlying the research work. In order to overcome any deficiency in the breadth of fundamental training or proper foundation for advanced work, special preliminary or pre-Ph.D. courses are given by each Department/Centre/School. These courses are given either by faculty members or by guest-speakers and specialists in the field of research.

5.13.1 Course requirements

Candidates admitted to non-engineering departments and having a B.Tech./M.Sc./M.A. or equivalent degree are required to complete a minimum of 12 credits. Relaxation up to 6 credits in the course work can be considered for those with an M.Phil. degree. The minimum requirement of pre-Ph.D. Course Credits/work for Ph.D. student admitted to an engineering department and having B.Tech./M.Sc. Degree is 20 credits. The minimum requirement of pre-Ph.D. Course Credits/work for Ph.D. student admitted to engineering department and having M.Tech. or equivalent Degree is 6 credits. Individual Academic Units may recommend course work requirements above the minimum requirements specified by the Institute.

Table 10. Continuation of Registration and Graduation Requirements for Postgraduate Programmes

Degree/Diploma	Registration limits (Per semester)	Criteria for continuation of registration	Graduation requirements		
			Valid Credits (\$)	Minimum DGPA	Max. Period of stay
P.G. D.I.I.T. (Naval Construction)	Minimum 12 credits Maximum 20 credits	CGPA > 5.0 at the end of each semester.	49	6.0	6 sem. #
Master of Public Policy	Minimum 12 credits Maximum 17 credits	(i) The minimum acceptable performance level in any registered semester is SGPA of 6.0. (ii) If at the end of any registered semester, the SGPA is less than 6.0 then the student will be issued a warning letter and placed on probation; a copy of the warning letter will be sent to the parents. The Chairperson DRC / CRC shall assess the feasibility of completing degree requirements and identify remedial measures for problems leading to poor performance. (iii) If a student is on probation and his/her academic performance is below the minimum acceptable level in the following registered semester then his/her registration will be terminated. (iv) The registration of any student will be limited to 1.25 times the average earned credits of the previous two registered semesters, subject to a minimum of 12 credits and a maximum of 17 credits.	54	6.0	6 sem.
M.Sc., Chemistry	Minimum 12 credits Maximum 26 credits	(i) The minimum acceptable performance level in any registered semester is SGPA of 5.0. (ii) If at the end of any registered semester, the SGPA is less than 5.0 then the student will be issued a warning letter and placed on probation; a copy of the warning letter will be sent to the parents. The Chairperson DRC/CRC shall assess the feasibility of completing degree requirements and identify remedial measures for problems leading to poor performance. (iii) If a student is on probation and his/her academic performance is below the minimum acceptable level in the following registered semester then his/her registration will be terminated. (iv) The registration of any student will be limited to 1.25 times the average earned credits of the previous two registered semesters, subject to a minimum of 15 credits and a maximum of 26 credits.	75-81	5.0	6 sem.
M.Sc., Cognitive Science					
M.Sc., Economics					
M.Sc., Mathematics					
M.Sc., Physics					
M.Tech., Full Time	Minimum 09 credits Maximum 15 credits	(i) The minimum acceptable performance level in any registered semester is SGPA of 6.0. (ii) If at the end of any registered semester the SGPA is less than 6.0, then the student will be issued a warning letter and placed on probation; a copy of the warning letter will be sent to Chairperson DRC/CRC. The Chairperson DRC/CRC shall assess the feasibility of completing degree requirements and identify remedial measures for problems leading to poor performance. (iii) If a student is on probation and his/her academic performance is below the minimum acceptable level in the following registered semester then his/her registration will be terminated. (iv) The registration of any student shall be limited to 1.25 times the average earned credits of the previous two registered semesters, subject to a minimum of 09 credits and a maximum of 15 credits for full time students.	48-54 credits	6.0	6 sem.
M.Tech., Part Time	Minimum 3 credits Maximum 12 credits				10 sem. @
M. Des.	Minimum 09 credits Maximum 15 credits		54	6.0	6 sem.
M.B.A., Full Time	Same as M.Tech. full time		72 (+ 6 compulsory audit courses)	6.0	6 sem.
M.B.A., Part Time	Same as M.Tech. part time				10 sem. @

M.S. (Res.) Full Time	See note +	(i) The minimum acceptable performance level in any registered semester is SGPA of 7.0 or more. (ii) If at the end of any registered semester, the SGPA is less than 7.0, then the student should be issued a warning letter and placed on probation; a copy of the warning letter should be sent to the Chairperson DRC/CRC. The Chairperson DRC/CRC shall assess the feasibility of completing degree requirements and identify remedial measures for problems leading to poor performance. (iii) If a student is on probation and his/her academic performance is below the minimum acceptable level in the following registered semester then his/her registration will be terminated. (iv) During the research work period, each unsatisfactory performance grade would entail a warning and two consecutive warnings would result in termination of registration.	51 including Thesis.	7.0	6 sem.
M.S. (Res.) Part Time	See note ++				10 sem. ***
Ph.D.	For details please refer to Ph.D. Ordinances and Regulations	(i) A student will be evaluated on completion of pre-Ph.D. course work in terms of Degree Grade Point Average (DGPA) which is calculated on the basis of the best valid credits as prescribed by the Department/Centre/School. The requirement for completion of pre-Ph.D. course work is DGPA of 7.5 or more. within the maximum permissible period i.e 18 and 24 months respectively for full-time and part time students. (ii) Registration of a Ph.D. student will be terminated at the end of 1st Semester on account of performance in the course work if the SGPA is less than 6.0. In case the SGPA is equal to or more than 6.0, the student will be allowed to continue the course work even if the credit requirements as recommended by the SRC have been completed in the first semester itself. (iii) In the subsequent semesters, the student must maintain a CGPA of more than 7.0 to continue registration.	12 for B.Tech./M.Sc., 6 for M.Tech. or equivalent; A Deptt./ Centre / School may prescribe additional credits + Thesis	7.5	14 sem.

NOTE:

- \$ Detailed break-up of core, elective and open category courses are given in the latter pages of this document.
- £ If a student at the end of the M.Tech. programme fails to complete required valid credits with a CGPA of 6.00 or above, he/she still can get a DIIT even though the Department/Interdisciplinary Programme does not have a regular Diploma programme provided: (i) he/she has secured a minimum of 36 valid credits; and (ii) he/she has secured a minimum CGPA of 5.50. The request for the award of D.I.I.T. must be made within 5 years of the date of joining the programme.
- + In the first semester the student has to register for a minimum of 9 and a maximum of 15 credits of course work only. In the subsequent 3-semester the student shall complete the research work and the course work remaining, if any.
- ++ In the first two semesters the part-time student shall register only for the course work with the minimum and maximum limits of 3-15 credits. The research work and the remaining course work, if any, shall be completed in the remaining 4 semesters. However, the course work must be completed within the first 4-semester of registration.
- +++ The 10 Semester rule for part-time M.S. (Research) students will be applicable only to those who have joined initially as part-time students. For students converting from full-time to part-time the maximum stay limit of 6 semesters will be applicable, subject to recommendations of DRC/CRC/SRC and approval by Dean, Academics.
- @ The 10 Semester rule for part-time M.Tech. students will be applicable only to those who have joined initially as part-time students. For students converting from full-time to part-time, the maximum stay limit of 6 semester will be applicable.
- # The summer semester will not be considered as a registered semester.

M.Tech. or equivalent degree holders admitted to Ph.D. are required to complete a minimum of 6 credits. The Departments /Centres/Schools may stipulate a larger number of credits in general or in specific cases. The course requirement will be determined by the Department/Centre/School Research Committee (DRC/CRC/SRC) on the recommendations of the supervisor after due consideration of the background of the student in relation to the proposed topic of research. These courses can be prescribed from existing M.Tech. courses and/or from special pre-Ph.D. courses including laboratory, seminar, foreign language, etc. Normally, no independent study course will be allowed for Ph.D. students. The pre-Ph.D. course credits that contribute to the DGPA of the Research Scholar can only be earned from regular lecture courses. In exceptional cases for Research Scholars who join the Ph.D. programme after B.Tech. (or equivalent) degree, a maximum of one course may be allowed having laboratory or programming content only. Such an exception would be allowed by the Dean, Academics on recommendation of the SRC of the student and the corresponding DRC/CRC.

Further, in case a Ph.D. student having completed 15 credits is unable to complete the research at the Ph.D. level for any reason whatsoever, he/she may be allowed to complete M.S. (Research) degree requirement as per Institute rules.

A student shall be formally registered/admitted to the candidacy of Ph.D. degree only after he/she has cleared the comprehensive examination. Students would be permitted to take the comprehensive examination only after they have submitted a research plan and have completed the course work (including compulsory audit course - HSL 800: Research Writing). Full-time and part-time students must clear the comprehensive examination within a period of 18 months and 24 months, respectively, from the date of joining. A maximum of two chances will be given to any student to clear the comprehensive examination. Every student, after having completed the comprehensive examination must formally register for the candidacy on a form obtainable from the PG Section.

5.13.2 Time limit

In addition to the information in Table 10, the time limits shown in Table 11 apply for Ph.D. work.

Table 11: Time limits for students registered under Ph.D. Programme

S. No.		Candidate's qualification	
		M.Tech. or equivalent	B.Tech./M.Sc. or equivalent
1	Limits for Registration		
1.1	Minimum period of registration	2 years	3 years (can be reduced to 2 years with the approval of Senate)
1.2	Normal maximum period of registration	10 Semesters	10 Semesters
1.3	Extended maximum period of registration	14 Semesters	14 Semesters
2	Conversion from Full-time to Part-time Registration	Comprehensive examination with the approval of Dean Academics	

5.13.3 Leave regulations

(a) Leave during course work

A full-time Ph.D. student, during his/her stay at the Institute will be entitled to leave for 30 days, including leave on medical grounds, per academic year. Even during mid-semester breaks, and summer and winter vacations, he/she will have to explicitly apply for leave. He/she, however, may be permitted to avail of leave only up to 15 days during winter vacation at the end of the first semester.

Leave beyond 30 days in an academic year may be granted to a research scholar in exceptional cases subject to the following conditions:

- (i) the leave beyond 30 days will be without Assistantship/Scholarship, and
- (ii) such an extension of up to additional 30 days will be granted only once during the programme of the scholar.

In addition, a Ph.D. student who has completed his/her course work may be granted leave on medical grounds up to 10 days per academic year.

Women research scholars will be eligible for Maternity Leave with assistantship for a period not exceeding 180 days once during the tenure of their Ph.D. programme.

The leave may be subject to the approval of the Head of Department/Centre/School/Programme Coordinator concerned on the recommendation of the Supervisor; and a proper leave account of each research scholar shall be maintained by the Department/Centre/School/Programme Coordinator concerned.

5.13.4 Attendance requirements for assistantship

Any full time Ph.D. student receiving assistantship or scholarship irrespective of the source while pursuing course work, must attend at least 75% of classes in each course in which he/she is registered. In case his/her attendance falls below 75% in any course during a month, he/she will not be paid assistantship for that month. Further, if his/her attendance again falls short of 75% in any course in any subsequent month in that semester, his/her studentship and assistantship will be terminated. A research scholar after having completed the course work must attend to his/her research work on all the working days and mark attendance except when he/she is on duly sanctioned leave. The requirement of 75% attendance will apply as above, on daily attendance except in the cases where longer leave has been duly sanctioned within the leave entitlement of the student. For the above purpose, if 75% works out to be a number which is not a whole number, the immediate lower whole number will be treated as the required 75% attendance.

All scholars who are offered assistantship are expected to put in 8 hours per week towards the work assigned by the Institute. Continuation of assistantship in the subsequent semester would be conditional, subject to satisfactory performance in the work assigned.

The above holds for Prime Minister's Research Fellowship (PMRF) scholars as well. Additional rules governing PMRF scholars may be announced from time to time.

5.13.5 Further regulations governing Ph.D. students

The Ph.D. degree of the Institute may be conferred on a candidate who fulfills all the requirements detailed in the Ordinances and other rules, approved by the Senate. Some of the important regulations are given below:

- (i) Applications for Ph.D. registration, i.e., for entry to a course of study and research leading to Ph.D. degree must be made to the Board of Academic Programmes (BAP) on the approved form. The date of registration is normally the date of joining the programme. However, in exceptional cases the date of registration may be preponed by a maximum of 6 months by the BAP if it is convinced that the candidate has spent adequate amount of time on research earlier.
- (ii) The academic programme of all the Ph.D. candidates in a Department/Centre/School will be coordinated by the DRC/CRC/SRC appointed by the BAP.
- (iii) The supervisor shall be a full-time member of the academic staff of the Institute. The supervisor(s) shall be appointed within three months of joining the programme. For this, Ph.D. candidates must fill up the required portion of the prescribed form, following which supervisor(s) must fill up the required portion, and the Student Research Committee (SRC) must be finalized by the respective DRC/CRC/SRC, of the Academic Unit. This process must be completed within three months of the Ph.D. candidate's date of first registration. If necessary, the Board of Academic Programme on the recommendations of the Supervisor through the DRC/CRC/SRC, may appoint Joint Supervisor(s) not exceeding two from inside or outside the Institute. Normally, there should not be more than two supervisors for a candidate from within the Institute. Appointment of any Joint Supervisor would not be permitted after a lapse of eighteen months from the date of registration of the candidate, except in cases when none of the supervisors is in the Institute for a year or more at a stretch.
- (iv) The DRC/CRC/SRC shall meet from time to time and review the progress of each candidate in the course work, as well as research, by any means, including oral examination of the candidate, if necessary, and recommend, after due consultation with the supervisor(s), such steps to the candidate as are necessary to improve his/her performance.
- (v) The progress of each candidate will be monitored by the DRC/CRC/SRC. For this purpose, the following procedures will be followed:
 - (a) Ph.D. research work will be compulsorily given a course number, DTD 899 (Doctoral Thesis) for all candidates across the Institute.
 - (b) The DRC/CRC/SRC Secretary/Ph.D. Coordinator will be coordinating the collection of progress reports written and signed by the scholars and forwarded by the supervisors every semester.
 - (c) The supervisor(s)/SRC/DRC/CRC will evaluate the progress of the student every semester.
 - (d) 'X' grade will be awarded if the progress is 'satisfactory' in that semester.
 - (e) If the progress is 'unsatisfactory', 'U' grade will be awarded. For the first appearance of 'U' grade, a warning would be issued to the candidate by Dean, Academics. If his/her performance does not improve after warning, the assistantship may be withheld.

- (f) If there are two consecutive 'U' grade (in consecutive semesters), the registration will stand terminated.
- (g) Submission of progress report should continue till submission of thesis.
- (h) Like all other courses, the grades for DTD 899 will be discussed in the Department/Centre/School as per the semester schedule.

The above process will continue till the thesis is submitted.

- (vi) The candidate may submit the thesis at any time provided that:
 - (a) He/she has completed the minimum period of registration including any extension prescribed by the Board of Academic Programmes (BAP).
 - (b) He/she has completed the course work requirement as prescribed by the DRC/CRC/SRC with DGPA not below 7.50 and has also cleared the comprehensive examination.
 - (c) He/she has submitted at least two months in advance, the title and a synopsis of the thesis. The Synopsis along with the list of examiners suggested by the supervisor needs to be approved by the DRC/CRC/SRC and then forwarded to Dean, Academics.
- (vii) The thesis shall normally be written in English in the specific format and shall contain a critical account of the candidate's research. It should be characterized by a discovery of facts, a fresh approach towards interpretation of facts and theories or significant contribution to knowledge of design or development, or a combination of them. It should bear evidence of the candidate's capacity for analysis and judgement and also his/her ability to carry out independent investigation, design or development. A thesis should normally be supplemented by published work. No part of the thesis or supplementary published work shall be submitted for the award of any other Degree/Diploma. Normally, three copies of thesis in soft cover have to be submitted in the format prescribed by the Institute. In case of joint supervision, four copies of the thesis are required to be submitted.
- (viii) On receipt of the title and synopsis of a thesis, the Dean, Academics will appoint a Board of Examiners for each candidate. The Board will consist of one (or two) internal examiner(s), normally the supervisor(s), and two external examiners, one from within India and one from abroad who shall be an expert in the subject of thesis. These external examiners shall be chosen from a list of eight, to be recommended by the supervisor(s) through the DRC/CRC/SRC while forwarding the title and synopsis of the thesis. The candidate will be required to submit a fresh synopsis if more than 9 months elapse from the synopsis submission date to the thesis submission date.
- (ix) Each Examiner will submit a detailed assessment report recommending to the BAP, one of the following courses of action:
 - (a) that the thesis be deemed satisfactory and that the candidate may defend his/her thesis orally before a committee constituted for the purpose and any members of the faculty and research students who wish to be present.
 - (b) that the candidate may submit a revised thesis before the expiry of a specific period. In the normal circumstances, he/she may submit the revised thesis within a period of one year from the date of communication in this regard from the Dean, Academics. However, in exceptional circumstances, this period may be extended by the BAP by another year: the total revision time irrespective of the number of revisions allowed will not exceed a period of two years.
 - (c) that the thesis be rejected outright.

In the event of disagreement between the external examiners, the BAP may, as a special case, appoint another external examiner, if the merit of the case so demands. The examiner will report independently to the BAP.
- (x) The oral defense of the thesis shall be conducted by a committee consisting of the internal examiner(s) and one external examiner. If none of the external examiners is available for the conduct of the oral defense, an alternative external examiner shall be appointed by the BAP for this purpose only.
- (xi) On the completion of all stages of the examination, the Oral Defense Committee shall recommend to the BAP one of the following courses of action:

- (a) that the degree be awarded.
- (b) that the candidate should be examined on a further occasion in a manner they shall prescribe.
- (c) that the degree shall not be awarded.

In the case of (a) above, the Oral Defense Committee shall also provide to the candidate a list of all corrections and modifications, if any, suggested by the examiners.

- (xii) The degree shall be awarded by the Senate, provided that:
 - (a) the Oral Defense Committee, through the BAP so recommends.
 - (b) the candidate produces a 'no dues certificate' from all concerned in the prescribed form and gets it forwarded along with the report of the Oral Defense Committee; and
 - (c) the candidate has submitted two hard cover copies of the thesis, after incorporating all necessary corrections and modifications including appropriate IPR notice. The hard-bound copies of the Ph.D. thesis, submitted after the viva-voce examination, must contain the appropriate copyright certificate in the beginning of the thesis, on a separate page on the left side. One of these copies is for the Department/Centre/School Library and the other is for the Central Library. A softcopy of the thesis has been submitted to the Central Library.
 - (d) A Hindi translation of the thesis abstract is to be submitted as part of final submission (after examiner reports are received). The students can seek assistance from Hindi Cell in this regard.
- (xiii) If a member of the academic staff, who is registered for the degree, leaves the Institute before the minimum period of registration is completed, he/she will be permitted to submit his thesis in due course, provided that:
 - (a) a substantial part of the research has been completed at the Institute; and
 - (b) any additional work required can be adequately supervised.
- (xiv) A member of the academic staff who has commenced his research before joining the Institute may, at the discretion of the BAP and on the recommendation of the Supervisor through the DRC/CRC/SRC concerned, be permitted to include in his period of registration, part or all of the time spent on research before joining the Institute, up to a maximum of one year.
- (xv) A member of the non-academic staff of the Institute who satisfies eligibility qualifications may be considered for admission to the degree as a part-time candidate provided his/her application is duly approved by the Director of the Institute.

6. SPECIAL PROVISIONS (ONLINE TEACHING OWING TO COVID-19) FOR SEMESTER I OF ACADEMIC YEAR 2021-22 FOR OTHER THAN UG FIRST YEAR COURSES

Semester I 2021-22 is to be conducted in online mode for teaching, evaluation and grading in view of Covid-19 outbreak. These rules are applicable only for semesters completed online fully or partially, and supersede the academic rules mentioned elsewhere in the document only for the duration of semesters affected by the Covid-19 pandemic.

Laboratory components (either independent courses or as part of a course) of Semester I 2021-22, may be conducted online (wherever possible, to be decided by Academic Units), or may be kept on hold (when online laboratory sessions are not possible). Such pending laboratory courses will be scheduled later, most likely during the latter half of Academic Year 2021-22. For courses in which the laboratory components are deferred, the courses with both L/T and P components will be split and the part with L/T component will be offered. The part of the course with P component will be offered later.

6.1 Special Provisions on Grading, and Registration for the Semesters Conducted Online

- a. Provisions for courses done on audit basis:
 - Up to 2 courses with a limit of one core/compulsory course can be done on audit basis in an online semester. Major Project for PG programmes (including Dual Degree), cannot be audited.
 - The default minimum marks for audit pass grade to be 30%. However, it can be changed in the range of 30-40% for a course and needs to be informed as a part of course evaluation policy in the first week of classes. The minimum marks for audit pass grade may not be same as minimum marks for D grade. These requirements need to be informed to students as part of the course evaluation policy in the first week of classes.
 - Some of the evaluation components of the courses with minimum performance in these evaluations may be made a necessary requirement of doing the course on audit basis and needs to be informed as a part of course evaluation policy in the first week of classes.
 - The performance in the evaluations conducted in a continuous manner during the semester is to be shared with the students by the respective Course Coordinator prior to the audit option time period. It is desirable to complete and share 30-40% evaluation before the start of the course audit-withdrawal window, so that the students have an idea about their performance in a course before they exercise the audit option.
 - PhD and MS(R) students may also exercise the Audit option for their registered online courses; however, such audited courses will not contribute to their pre-PhD coursework requirements. In case they audit a course, they must register for some other course as per the advice of their supervisor's/programme coordinators in subsequent semesters to complete their pre-PhD coursework requirements.
- b. Attendance policy, suitably accommodative of online environment (limited or interruptive connectivity at students end), may be a part of course evaluation policy. A priori approval of any deviation from the approved attendance policies (for normal semesters), as listed in the Courses of Study, must be obtained from Dean Academics.
- c. The lower limit of the range of marks for the D grade (for courses being done on credit basis) to remain fixed at 30% for online semesters.
- d. The 60-teaching day (with rest of the course contents covered optionally though asynchronous online lectures, or in-person lectures conducted on buffer days or outside slot hours), with one-minor, one-major model to continue until the pandemic situation ends and complete normalcy and in-campus academic activities are restored.

6.2 Special Provisions on Continuation/Termination of Registration and Assistantships for the Semesters Conducted Online

- a. In the criteria for continuation/termination, probation, continuation of assistantship/scholarships, etc., the CGPA/SGPA part of the criteria will not be applicable for the semesters conducted online.
- b. There is no change in the minimum earned credits for any of these criteria except that the clause for student on probation will remain suspended for semesters conducted partly or completely in online mode. For example,

there will not be any change in the Restart/Termination criteria applicable to UG students at the end of First Year as it is based entirely on the earned credits.

- c. A student may opt to withdraw from online semesters on grounds that it is not possible to cope up with the online teaching and these withdrawals will not count towards the maximum number of withdrawals or maximum number of semesters allowed for the programme. The last date for application of withdrawal must be before the first day of Major examination/evaluation of the semester.
- d. As the Covid outbreak and subsequent impact of academics in all institutions, including IIT Delhi, is an evolving situation, the above provisions may be reviewed at any time by the Senate, and any revised provisions that the Senate wishes to put in place will be applicable to all currently registered students of IIT Delhi.

6.3 Special Provisions Applicable to Ph.D./M.S.(R) Students

- a. Ph.D. students may exercise the Audit option for their registered online courses; however, such audited courses will not contribute to their pre-Ph.D. coursework requirements. In case they audit a course, they must register for some other course as per the advice of their supervisors/programme coordinators in subsequent semesters to complete their pre-Ph.D. coursework requirements.
- b. For all research scholars registered in IIT Delhi as on 28.04.2021, for Written Comprehensive and Presentation of Research Plan, 6 months (183 days) ad hoc extension is recommended from the calendar due dates (in case these examinations are not already completed).
- c. For Ph.D. students registered in 2017 and prior, an ad hoc one-time six-month extension (183 days) for thesis submission beyond the Senate-mandated 7 years is approved (the net relaxation under this provision is no more than 6 months (183 days)). In case students continue in the “15th registered Semester”, they will need to register but the fees would be waived. A research scholar (2017 and prior registration) will be able to avail this default provision only once.
- d. Similar extension for M.S.(R) students registered in 2019 and prior (the net relaxation under this provision is no more than 6 months (183 days)). An M.S.(R) student (2019 and prior registration) will be able to avail this default provision only once.
- e. Provisions for Ph.D./M.S.(R) students for Online Progress Presentations, Online/Take-home Written Comprehensive Examination, Oral Comprehensive Examination (presentations of research plan), Pre-Ph.D. Synopsis seminar, and Ph.D. viva, are to continue. Ph.D. viva may be conducted by the DRC Chairperson or her/his nominee and may be conducted through any video conferencing platform that has been adopted by the Institute. Link to the recording may be shared with the Office of Dean Academics along with submission of Ph.D. viva reports.

7. UNDERGRADUATE PROGRAMME STRUCTURES

Bachelor of Technology in Engineering and Computational Mechanics

Department of Applied Mechanics

The overall Credit Structure

Course Category	Credits
Institute Core Courses	
Basic Sciences (BS)	24
Engineering Arts and Science (EAS)	19
Humanities and Social Sciences (HuSS)	15
Programme-linked Courses	12.5
Departmental Courses	
Departmental Core	65.5
Departmental Electives	12
Open Category Courses	10
Total Graded Credit requirement	158
Non Graded Units	11

Institute Core : Basic Sciences

CML101	Introduction to Chemistry	3	1	0	4
CMP100	Chemistry Laboratory	0	0	4	2
MTL100	Calculus	3	1	0	4
MTL101	Linear Algebra and Differential Equations	3	1	0	4
PYL101	Electromagnetism & Quantum Mechanics	3	1	0	4
PYP100	Physics Laboratory	0	0	4	2
SBL100	Introductory Biology for Engineers	3	0	2	4
Total Credits		24			

Institute Core: Engineering Arts and Sciences

APL100	Engineering Mechanics	3	1	0	4
COL100	Introduction to Computer Science	3	0	2	4
CVL100	Environmental Science	2	0	0	2
ELL101	Introduction to Electrical Engineering	3	1	0	4
ELP101	Introduction to Electrical Engineering (Lab)	0	0	2	1
MCP100	Introduction to Engineering Visualization	0	0	4	2
MCP101	Product Realization through Manufacturing	0	0	4	2
Total Credits		19			

Programme-Linked Basic/Engineering Arts/Sciences Core

MTL107	Numerical Methods and Computations	3	0	0	3
COL106	Data Structures and Algorithms	3	0	4	5
ELL 201	Digital Electronics	3	0	3	4.5
Total Credits		12.5			

Humanities and Social Sciences

Courses from Humanities, Social Sciences and Management offered under this category	15
---	-----------

Departmental Core

APL101	Applied Mathematics for Engineers	3	0	0	3
MLL100	Introduction to Material Science and Engg.*	3	0	2	4
APL103	Experimental Methods	3	0	2	4
APL104	Solid Mechanics	3	1	0	4
APL106	Fluid Mechanics	3	1	0	4
APL203	Dynamics of Mechanical Systems	3	1	0	4
APL205	Basics of Computer Aided Design	2	0	0	2
APL206	Engineering Thermodynamics	2	0	0	2
APL207	Heat Transfer	2	0	0	2
AMP262	Solid & Fluids Lab	0	0	4	2
APL302	Basics of Product Design	3	0	2	4
APL311	Introduction to Finite Element Method	3	0	2	4
APL321	Introduction to Computational Fluid Dynamics	3	0	2	4
APL331	Advanced Mechanics of Solids	3	0	0	3
APL361	Advanced Fluid Dynamics	3	0	0	3
APL380	Bio-mechanics	3	0	0	3
APL390	Experimental Techniques in Fluids and Solids	2	0	3	3.5

APL405	Machine Learning in Mechanics	2	0	2	3
APL410	Multi-Scale Modeling and Computation	3	0	0	3
APD411	B.Tech. Project-I	0	0	8	4

Total Credits

65.5

* APL102 is superseded by MLL100

Departmental Electives

APL306	Vibration	3	0	0	3
APL340	Chaos	3	1	0	4
APL402	Fluid Structure Interaction	3	0	0	3
APL411	Application of Finite Element Methods	2	0	2	3
APD412	B.Tech Project II	0	0	12	6
APL412	Computational Multibody Dynamics	3	0	0	3
APL415	Composite Mechanics and Structures	3	0	0	3
APL421	Application of CFD	2	0	2	3
APL422	Advanced Computational Fluid Dynamics	2	0	2	3
APL424	Introduction to Hydrodynamics Stability	3	0	0	3
APL431	Aircraft Structures	3	0	0	3
APL432	Aero-Elasticity	3	0	0	3
APL433	Introduction to Plates and Shells	3	0	0	3
APL434	Smart Material and Structures	3	0	0	3
APL435	Impact Mechanics and Crash Worthiness	3	0	0	3
APL440	Parallel Processing in Computational Mechanics	3	0	2	4
APL450	Introduction to Soft Robotics	3	0	0	3
APL452	Introduction to Digital Twins	2	0	2	3
APL491	Reliability Engineering	3	0	0	3
APL701	Continuum Mechanics	3	0	0	3
APL713	Turbulence and its Modeling	3	0	0	3
APL715	Physics of Turbulent Flow	3	0	0	3
APL736	Multiscale Modeling of Crystalline Materials	3	0	2	4
ALP737	Advanced Design of Machine Elements	3	0	0	3
APL740	Mechanics of Biological Cells	3	0	2	3
APL742	Advanced Bio-Mechanics	3	0	0	3
APL745	Deep Learning for Mechanics	3	0	2	4
APL764	Biomaterials	3	0	0	3
APL765	Fracture Mechanics	3	0	0	3
APL771	Design Optimization and Design Theory	3	0	0	3
ELL715	Digital Image processing	3	0	0	3
ELL794	Human Computer Interface	3	0	0	3
APL805	Advanced Finite Element methods	3	0	0	3

Suggested Courses under Open Elective Courses

COL216	Computer Architecture	3	0	2	4
COL334	Computer Networks	3	0	2	4
COL341	Fundamentals of Machine Learning	3	0	2	4
COL333	Principles of Artificial Intelligence	3	0	2	4
COL362	Introduction to Database Mgmt. System	3	0	2	4
MTL180	Discrete Mathematical Structures	3	1	0	4
MTL290	Computing Laboratory	0	0	4	2
MTL342	Analysis and Design of Algorithms	3	1	0	4
MTL458	Operating Systems	3	0	2	4
MTL415	Parallel Algorithms	3	0	0	3

Suggested Courses under HUSS

HUL211	Introduction to Economics	3	1	0	4
HUL212	Micro Economics	3	1	0	4
HUL213	Macro Economics	3	1	0	4
HUL261	Introduction to Psychology	3	1	0	4
MSL301	Organization and People Management	3	0	0	3
MSL302	Managerial Accounts and Financial Mgmt.	3	0	0	3
MSL708	Financial Management	3	0	0	3
MSL704	Science & Technology Policy Systems	3	0	0	3

Semester	Course-1		Course-2		Course-3		Course-4		Course-5		Course-6		Course-7		Course-8		Course-9		Course-10		L	T	P	Credits	Non-Graded Units	Contact Hours
	ELL101	ELP101	MCP100	PYL101	MTL100	PYP100	MCP101	NIN100	NEN100	MLN100	NEN100	MLN100	MLN100	MLN100	MLN100	MLN100	MLN100	MLN100	MLN100	MLN100						
I	Introduction to Electrical Engg.	Introduction to Electrical Engg. (Lab.)	Introduction to Engineering Visualization	Electromagnetism & Quantum Mechanics	Calculus	Physics Laboratory	Product Realization through Manufacturing	Introduction to Engineering (Non-graded)	Professional Ethics and Social Responsibility-1 (Non-graded)	Language and Writing Skills-1 (Non-Graded)																
	3 1 0 4	0 0 2 1	0 0 4 2	3 1 0 4	3 1 0 4	0 0 4 2	0 0 4 2	0 0 4 2	0 0 4 2	0 0 4 2	0 0 4 2	0 0 4 2	0 0 4 2	0 0 4 2	0 0 4 2	0 0 4 2	0 0 4 2	0 0 4 2	0 0 4 2	0 0 4 2	0 0 4 2	9.0	3	14	19.0	2.5
II	Engineering Mechanics	Introduction to Computer Science	Introduction to Chemistry	Linear Algebra and Differential Equations	Chemistry Laboratory																					
	3 1 0 4	3 0 2 4	3 1 0 4	3 1 0 4	0 0 4 2																	12	3	6	18.0	1.5
Note: Courses 1-6 above are attended in the given order by half of all first year students. The other half of First year students attend the Courses 1-6 of II semester first.																										
III	Introduction to Materials Science and Engineering	Fluid Mechanics	Solid Mechanics	Applied mathematics for Engineers	Introduction to Biology for Engineers																					
	3 0 2 4	3 1 0 4	3 1 0 4	3 0 0 3	3 0 2 4																15	2	4	19.0	0	21.0
IV	Experimental Methods	Data Structures and Algorithms	Numerical Methods and Computations	Digital Electronics	Environmental Science																					
	3 0 2 4	3 0 4 5	3 0 0 3	3 0 3 4.5	2 0 0 2																19	0	9	23.5	0	28.0
V	Dynamics of Mechanical System	Basics of Computer Aided Design	Fluids and Solids Laboratory	Basics of Product Design	Bio-mechanics																					
	3 1 0 4	2 0 0 2	0 0 4 2	3 0 2 4	3 0 0 3																16	1	6	20.0	0	23.0
VI	Advanced Mechanics of Solids	Advanced Fluid Dynamics	Introduction to Finite Element Methods	Advanced Experiments in Solids & Fluids																						
	3 0 0 3	3 0 0 3	3 0 2 4	2 0 3 3.5																	17	0	5	19.5	0	22.0
VII		Multi-scale Modeling and Computation	Intro. to Computational Fluid Dynamics	Machine Learning in Mechanics																						
	3 0 0 3	3 0 0 3	3 0 2 4	2 0 2 3	3 0 0 3																16	0	12	22.0	0	28.0
VIII	APD412	DE3	DE4	OC3	OC4																					
	0 0 12 6	3 0 0 3	3 0 0 3	2 0 0 2	3 0 0 3																11	0	12	17.0	0	23.0

TOTAL=158

Bachelor of Technology in Biochemical Engineering and Biotechnology

Department of Biochemical Engineering and Biotechnology

The overall Credit Structure

Course Category	Credits
Institute Core Courses	
Basic Sciences (BS)	24
Engineering Arts and Science (EAS)	19
Humanities and Social Sciences (HuSS)	15
Programme-linked Courses	11
Departmental Courses	
Departmental Core	69
Departmental Electives	10
Open Category Courses	10
Total Graded Credit requirement	158
Non Graded Units	11

Institute Core : Basic Sciences

CML101	Introduction to Chemistry	3	1	0	4
CMP100	Chemistry Laboratory	0	0	4	2
MTL100	Calculus	3	1	0	4
MTL101	Linear Algebra and Differential Equations	3	1	0	4
PYL101	Electromagnetism & Quantum Mechanics	3	1	0	4
PYP100	Physics Laboratory	0	0	4	2
SBL100	Introductory Biology for Engineers	3	0	2	4
Total Credits					24

Institute Core: Engineering Arts and Sciences

APL100	Engineering Mechanics	3	1	0	4
COL100	Introduction to Computer Science	3	0	2	4
CVL100	Environmental Science	2	0	0	2
ELL101	Introduction to Electrical Engineering	3	1	0	4
ELP101	Introduction to Electrical Engineering (Lab)	0	0	2	1
MCP100	Introduction to Engineering Visualization	0	0	4	2
MCP101	Product Realization through Manufacturing	0	0	4	2
Total Credits					19

Programme-Linked Basic/Engineering Arts/Sciences Core

MLL100	Introduction to Materials Science and Engineering*	3	0	2	4
CLL110	Transport Phenomena	3	1	0	4
MTL102	Differential Equations	3	0	0	3
Total Credits					11

* APL102 is superseded by MLL100

Humanities and Social Sciences

Courses from Humanities, Social Sciences and Management offered under this category **15**

Departmental Core

BBL131	Principles of Biochemistry	3	0	3	4.5
BBL132	General Microbiology	3	0	3	4.5
BBL133	Mass and Energy Balances in Biochemical Engineering	3	0	0	3
BBL231	Molecular Biology and Genetics	3	0	3	4.5
BBL331	Bioprocess Engineering	3	0	0	3
BBP332	Bioprocess Engineering Laboratory	0	0	3	1.5

BBL431	Bioprocess Technology	2	0	0	2
BBL432	Fluid Solid Systems	2	0	0	2
BBL433	Enzyme Science and Engineering	3	0	2	4
BBL434	Bioinformatics	2	0	2	3
BBD451	Major Project Part-I (BB1)	0	0	6	3
BBL731	Bioseparation Engineering	3	0	3	4.5
BBL732	Bioprocess Plant Design	3	0	2	4
BBL733	Recombinant DNA Technology	2	0	3	3.5
CLL122	Chemical Reaction Engineering-I	3	1	0	4
CLL231	Fluid Mechanics for Chemical Engineers	3	1	0	4
CLL251	Heat Transfer for Chemical Engineers	3	1	0	4
CLL252	Mass Transfer-I	3	0	0	3
CLL261	Process Dynamics and Control	3	1	0	4
CLP301	Chemical Engineering Laboratory-I	0	0	3	1.5
CLP302	Chemical Engineering Laboratory-II	0	0	3	1.5
Total Credits					69

Departmental Electives

BBL341	Environmental Biotechnology	3	0	0	3
BBL342	Physical and Chemical Properties of Biomolecules	2	1	0	3
BBL343	Carbohydrates and Lipids in Biotechnology	2	1	0	3
BBV350	Special Module in Biochemical Engineering and Biotechnology	1	0	0	1
BBD351	Mini Project (BB)	0	0	6	3
BBL441	Food Science and Engineering	3	0	0	3
BBL442	Immunology	3	0	2	4
BBL443	Modeling and Simulation of Bioprocesses	3	0	2	4
BBL444	Advanced Bioprocess Control	3	0	0	3
BBL445	Membrane Applications in Bioprocessing	3	0	0	3
BBL446	Biophysics	3	0	0	3
BBL447	Enzyme Catalyzed Organic Synthesis	2	0	2	3
BBD452	Major Project Part-II (BB1)	0	0	16	8
CLL477	Materials of Construction	3	0	0	3
BBL734	Metabolic Regulation and Engineering	3	0	0	3
BBL735	Genomics and Proteomics	2	0	2	3
BBL736	Dynamics of Microbial Systems	3	0	0	3
BBL737	Instrumentation and Analytical Methods in Bioengineering	2	0	2	3
BBL740	Plant Cell Technology	3	0	2	4
BBL741	Protein Science and Engineering	3	0	0	3
BBL742	Biological Waste Treatment	3	0	2	4
BBL743	High Resolution Methods in Biotechnology	2	0	2	3
BBL744	Animal Cell Technology	3	0	2	4
BBL745	Combinatorial Biotechnology	3	0	0	3
BBL746	Current Topics in Biochemical Engineering and Biotechnology	3	0	0	3
BBL747	Bionanotechnology	3	0	0	3
BBL748	Data Analysis for DNA Microarrays	3	0	2	4
BBL749	Cancer Cell Biology	3	0	3	4.5
BBL750	Genome Engineering	2	0	2	3
BBL751	Biotechnology Entrepreneurship	2	0	0	2
BBL752	Microbial Ecology	3	0	0	3
BBL754	Optics within Life Science	3	0	0	3
BBL756	Plasmid Biology	3	0	0	3
CLL728	Biomass Conversion and Utilization	3	0	0	3

Semester	Course-1	Course-2	Course-3	Course-4	Course-5	Course-6	Course-7	Course-8	Course-9	Course-10	L	T	P	Credits	Non-Graded Units	Contact Hours	
I	ELL101 Introduction to Electrical Engineering	ELP101 Introduction to Electrical Engineering (Lab.)	MCP100 Introduction to Engineering Visualization	PYL101 Electromagnetism & Quantum Mechanics	MTL100 Calculus	PYP100 Physics Laboratory	MCP101 Product Realization through Manufacturing	NIN100 Introduction to Engineering (Non-graded)	NEN100 Professional Ethics and Social Responsibility-1 (Non-graded)	MLN100 Language and Writing Skills-1 (Non-Graded)	9.0	3	14	19.0	2.5	31.0	
	APL100 Engineering Mechanics	COL100 Introduction to Computer Science	CML101 Introduction to Chemistry	MTL101 Linear Algebra and Differential Equations	CMP100 Chemistry Laboratory			NEN101 Professional Ethics and Social Responsibility-2 (Non-graded)	MLN101 Language and Writing Skills-2 (Non-Graded)		12	3	6	18.0	1.5	24.0	
<p>Note: Courses 1-6 above are attended in the given order by half of all first year students. The other half of First year students attend the Courses 1-6 of II semester first.</p>																	
III	MLL100 Introduction to Materials Science and Engineering	CLL110 Transport Phenomena	SBL100 Introductory Biology for Engineers	BBL131 Principles of Biochemistry	BBL132 General Microbiology	BBL133 Mass and Energy Balances in Biochemical Engg.											
	CLL251 Heat Transfer for Chemical Engineers	CLL122 Chemical Reaction Engineering I	CLL231 Fluid Mechanics for Chemical Engineers	CVL100 Environmental Science	BBL231 Molecular Biology and Genetics	HUL2XX Humanities Elective-1					18	1	10	24.0	0	29.0	
IV	MTL102 Differential Equations	CLL252 Mass Transfer I	CLL261 Process Dynamics and Control	CLP301 Chemical Engineering Laboratory I	BBP332 Bioprocess Engineering Laboratory	BBL331 Bioprocess Engineering	HUL2XX Humanities Elective-2				17	4	3	22.5	0	24.0	
	CLP302 Chemical Engineering Laboratory II	HUL2XX Humanities Elective-3	BBL432 Fluid Solid Systems	BBL434 Bioinformatics	BBL433 Enzyme Science and Engineering	BBL431 Bioprocess Technology					15	2	6	20.0	0	23.0	
VI	HUL3XX Humanities Elective-4	OC1 (4)	BED451 B. Tech. Project	BBL731 Bioprocess Plant Design	BBL732 Bioprocess Plant Design	BBL733 Recombinant DNA Technology					12	1	7	16.5	0	20.0	
	DE1 (4)	DE2 (3)	DE3 (3)	OC2 (3)	OC3 (3)						14	0	16	22.0	0	30.0	
VIII	3	0	2	4	3	0	0	3	3	0	0	3	3	0	0	3	17.0
																TOTAL=158.0	

Bachelor of Technology in Chemical Engineering

Department of Chemical Engineering

The overall Credit Structure

Course Category	Credits
Institute Core Courses	
Basic Sciences (BS)	24
Engineering Arts and Science (EAS)	19
Humanities and Social Sciences (HuSS)	15
Programme-linked Courses	7
Departmental Courses	
Departmental Core	67
Departmental Electives	12
Open Category Courses	10
Total Graded Credit requirement	154
Non Graded Units	11

Institute Core: Basic Sciences

CML101	Introduction to Chemistry	3	1	0	4
CMP100	Chemistry Laboratory	0	0	4	2
MTL100	Calculus	3	1	0	4
MTL101	Linear Algebra and Differential Equations	3	1	0	4
PYL101	Electromagnetism & Quantum Mechanics	3	1	0	4
PYP100	Physics Laboratory	0	0	4	2
SBL100	Introductory Biology for Engineers	3	0	2	4
Total Credits					24

Institute Core: Engineering Arts and Sciences

APL100	Engineering Mechanics	3	1	0	4
COL100	Introduction to Computer Science	3	0	2	4
CVL100	Environmental Science	2	0	0	2
ELL101	Introduction to Electrical Engineering	3	1	0	4
ELP101	Introduction to Electrical Engineering (Lab)	0	0	2	1
MCP100	Introduction to Engineering Visualization	0	0	4	2
MCP101	Product Realization through Manufacturing	0	0	4	2
Total Credits					19

Programme-Linked Basic/Engineering Arts/Sciences Core

MLL100	Introduction to Materials Science and Engineering*	3	0	2	4
CML103	Applied Chemistry - Chemistry at Interfaces	3	0	0	3
Total Credits					7

* APL102 is superseded by MLL100

Humanities and Social Sciences

Courses from Humanities, Social Sciences and Management offered under this category	15
---	-----------

Departmental Core

CLL110	Transport Phenomena	3	1	0	4
CLL111	Material and Energy Balances	2	2	0	4
CLL113	Numerical Methods in Chemical Engineering	3	0	2	4
CLL121	Chemical Engineering Thermodynamics	3	1	0	4
CLL122	Chemical Reaction Engineering-I	3	1	0	4
CLL141	Intro. to Materials for Chemical Engineers	3	0	0	3
CLL222	Chemical Reaction Engineering-II	3	0	0	3
CLL231	Fluid Mechanics for Chemical Engineers	3	1	0	4
CLL251	Heat Transfer for Chemical Engineers	3	1	0	4
CLL252	Mass Transfer-I	3	0	0	3
CLL261	Process Dynamics and Control	3	1	0	4
CLL271	Introduction to Industrial Biotechnology	3	0	0	3
CLP301	Chemical Engineering Laboratory-I	0	0	3	1.5
CLP302	Chemical Engineering Laboratory-II	0	0	3	1.5
CLP303	Chemical Engineering Laboratory-III	0	0	3	1.5
CLL331	Fluid-Particle Mechanics	3	1	0	4
CLL352	Mass Transfer-II	3	1	0	4
CLL361	Instrumentation and Automation	1	0	3	2.5
CLL371	Chemical Process Technology and Economics	3	1	0	4
CLD411	B.Tech. project	0	0	8	4
Total Credits					67

Departmental Electives

CLL133	Powder Processing and Technology	3	0	0	3
CLL296	Nano-engineering of Soft Materials	3	0	0	3
CLL390	Process Utilities and Pipeline Design	3	0	0	3
CLL402	Process Plant Design	3	0	0	3

CLD412*	Major Project in Energy and Environment	0	0	10	5
CLD413*	Major Project in Complex Fluids	0	0	10	5
CLD414*	Major Project in Process Engineering, Modeling and Optimization	0	0	10	5
CLD415*	Major Project in Biopharmaceuticals and Fine Chemicals	0	0	10	5
CLL475	Safety and Hazards in Process Industries	3	0	0	3
CLL477	Materials of Construction	3	0	0	3
CLL705	Petroleum Reservoir Engineering	3	0	0	3
CLL706	Petroleum Production Engineering	3	0	0	3
CLL707	Population Balance Modeling	3	0	0	3
CLL720	Principles of Electrochemical Engineering	3	0	0	3
CLL721	Electrochemical Methods	3	0	0	3
CLL722	Electrochemical Conversion and Storage Devices	3	0	0	3
CLL723	Hydrogen Energy and Fuel Cell Technology	3	0	0	3
CLL724	Environmental Engineering and Waste Mgmt	3	0	0	3
CLL725	Air Pollution Control Engineering	3	0	0	3
CLL726	Molecular Modeling of Catalytic Reactions	3	0	0	3
CLL727	Heterogeneous Catalysis and Catalytic Reactors	3	0	0	3
CLL728	Biomass Conversion and Utilization	3	0	0	3
CLL729	Colloids and Aerosols	3	0	0	3
CLL730	Structure, Transport and Reactions in BioNano Systems	3	0	0	3
CLL731	Advanced Transport Phenomena	3	0	0	3
CLL732	Advanced Chemical Engineering Thermodynamics	3	0	0	3
CLL733	Industrial Multiphase Reactors	3	0	0	3
CLL734	Process Intensification and Novel Reactors	3	0	0	3
CLL735	Design of Multicomponent Separation Process	3	0	0	3
CLL736	Experimental Characterization of Multiphase Reactors	3	0	0	3
CLL742	Experimental Characterization of BioMacromolecules	3	0	0	3
CLL743	Petrochemicals Technology	3	0	0	3
CLL760	Crystal Engineering and Design	3	0	0	3
CLL761	Chemical Engineering Mathematics	3	0	0	3
CLL762	Advanced Computational Techniques in Chemical Engineering	2	0	2	3
CLL766	Interfacial Engineering	3	0	0	3
CLL767	Structures and Properties of Polymers	3	0	0	3
CLL768	Fundamentals of Computational Fluid Dynamics	2	0	2	3
CLL769	Applications of Computational Fluid Dynamics	2	0	2	3
CLL771	Introduction to Complex Fluids	3	0	0	3
CLL772	Transport Phenomena in Complex Fluids	3	0	0	3
CLL773	Thermodynamics of Complex Fluids	3	0	0	3
CLL774	Simulation Techniques for Complex Fluids	3	0	0	3
CLL775	Polymerization Process Modeling	3	0	0	3
CLL776	Granular Materials	3	0	0	3
CLL777	Complex Fluids Technology	3	0	0	3
CLL778	Interfacial Behaviour and Transport of Biomolecules	3	0	0	3
CLL779	Molecular Biotechnology and in-vitro Diagnostics	3	0	0	3
CLL780	Bioprocessing and Bioseparations	3	0	0	3
CLL781	Process Operations Scheduling	3	0	0	3
CLL782	Process Optimization	3	0	0	3
CLL783	Advanced Process Control	3	0	0	3
CLL784	Process Modeling and Simulation	3	0	0	3
CLL785	Evolutionary Optimization	3	0	0	3
CLL786	Fine Chemicals Technology	3	0	0	3
CLL787	Statistical Methods for Chemical Engineering	3	0	0	3
CLL788	Process Data Analytics	3	0	0	3
CLL789	Applied Time Series Analysis for Chemical Engineering	3	0	0	3
CLL791	Chemical Product and Process Integration	3	0	0	3
CLL792	Chemical Product Development and Commercialization	3	0	0	3
CLL793	Membrane Science and Engineering	3	0	0	3
CLL794	Petroleum Refinery Engineering	3	0	0	3
CLV796	Current Topics in Chemical Engineering	1	0	0	1
CLV797	Recent Advances in Chemical Engineering	2	0	0	2
CLL798	Selected Topics in Chemical Engineering-I	3	0	0	3
CLL799	Selected Topics in Chemical Engineering-II	3	0	0	3

*Student can take any one of these course.

Semester	Course-1	Course-2	Course-3	Course-4	Course-5	Course-6	Course-7	Course-8	Course-9	Course-10	L	T	P	Credits	Non-Graded Units	Contact Hours
I	ELL101 Introduction to Electrical Engineering	ELP101 Introduction to Electrical Engineering (Lab.)	MCP100 Introduction to Engineering Visualization	PYL101 Electromagnetism & Quantum Mechanics	MTL100 Calculus	PYP100 Physics Laboratory	MCP101 Product Realization through Manufacturing	NIN100 Introduction to Engineering (Non-graded)	NEN100 Professional Ethics and Social Responsibility-1 (Non-graded)	NLN100 Language and Writing Skills-1 (Non-Graded)						
	APL100 Engineering Mechanics	COL100 Introduction to Computer Science	CML101 Introduction to Chemistry	MTL101 Linear Algebra and Differential Equations	CMP100 Chemistry Laboratory			NEN101 Professional Ethics and Social Responsibility-2 (Non-graded)	NLN101 Language and Writing Skills-2 (Non-Graded)		9.0	3	14	19.0	2.5	31.0
	3 1 0 4	3 0 2 4	3 1 0 4	3 1 0 4	3 0 0 4	3 1 0 4	3 0 0 4	3 0 0 4	3 0 0 4	3 0 0 4	3 0 0 4	3	0	14	19.0	2.5
II																
	3 1 0 4	3 0 2 4	3 1 0 4	3 1 0 4	3 0 0 4	3 1 0 4	3 0 0 4	3 0 0 4	3 0 0 4	3 0 0 4	12	3	6	18.0	1.5	24.0
Note: Courses 1-6 above are attended in the given order by half of all first year students. The other half of First year students attend the Courses 1-6 of II semester first.																
III	CLL110 Transport Phenomena	CLL111 Material and Energy Balances	CLL113 Numerical Methods in Chemical Engineering	CML103 Applied Chemistry: Chemistry at Interfaces	HUL2XX											
	3 1 0 4	2 2 0 4	3 0 2 4	3 0 0 3	3 1 0 4						14	4	2	19.0	0	20.0
	3 1 0 4	2 2 0 4	3 0 2 4	3 0 0 3	3 1 0 4											
IV	CLL121 Chemical Engineering Thermodynamics	CLL122 Chemical Reaction Engineering I	CLL231 Fluid Mechanics for Chemical Engineers	CLL251 Heat Transfer for Chemical Engineers	SBL100 Introductory Biology for Engineers	MLL100 Introduction to Materials Science and Engineering										
	3 1 0 4	3 1 0 4	3 1 0 4	3 1 0 4	3 0 2 4	3 0 2 4					18	4	4	24.0	0	26.0
	3 1 0 4	3 1 0 4	3 1 0 4	3 1 0 4	3 0 2 4	3 0 2 4										
V	CLL252 Mass Transfer I	CLL222 Chemical Reaction Engineering II	CLL331 Fluid-Particle Mechanics	CLL141 Introduction to Materials for Chemical Engineers	CLL261 Process Dynamics and Control	CVL100 Environmental Science	CLP301 Chemical Engineering Laboratory I									
	3 0 0 3	3 0 0 3	3 1 0 4	3 0 0 3	3 1 0 4	2 0 0 2	0 0 3 1.5				17	2	3	20.5	0	22.0
	3 0 0 3	3 0 0 3	3 1 0 4	3 0 0 3	3 1 0 4	2 0 0 2	0 0 3 1.5									
VI	CLL352 Mass Transfer II	DE 1	CLL271 Introduction to Industrial Biotechnology	CLL371 Chemical Process Technology and Economics	CLL361 Instrumentation and Automation	HUL2XX	CLP302 Chemical Engineering Laboratory II									
	3 1 0 4	3 0 0 3	3 0 0 3	3 1 0 4	1 0 3 2.5	3 1 0 4	0 0 3 1.5				16	3	6	22.0	0	25.0
	3 1 0 4	3 0 0 3	3 0 0 3	3 1 0 4	1 0 3 2.5	3 1 0 4	0 0 3 1.5									
VII	DE 2	DE 3 / OC 1	OC 2	CLP303 Chemical Engineering Laboratory III	CLD411 B. Tech. Project	HUL2XX										
	3 0 0 3	3 0 0 3	3 1 0 4	0 0 3 1.5	0 0 8 4	3 1 0 4					12	2	11	19.5	0	25.0
	3 0 0 3	3 0 0 3	3 1 0 4	0 0 3 1.5	0 0 8 4	3 1 0 4										
VIII	OC1 / DE 3	DE 4	OC 3	HUL3XX												
	3 0 0 3	3 0 0 3	3 0 0 3	3 0 0 3							12	0	0	12.0	0	12.0
	3 0 0 3	3 0 0 3	3 0 0 3	3 0 0 3												
TOTAL=154.0																

Dual Degree Programme : Bachelor of Technology and Master of Technology in Chemical Engineering

Department of Chemical Engineering

The overall Credit Structure

Course Category	Credits
B.Tech. Part	
Institute Core Courses	
Basic Sciences (BS)	24
Engineering Arts and Science (EAS)	19
Humanities and Social Sciences (HuSS)	15
Programme-linked Courses	7
Departmental Courses	
Departmental Core	63
Departmental Electives	09
Open Category Courses	3
Total B.Tech. Credit Requirement	140
Non Graded Units	11
M.Tech. Part	
Programme Core Courses	33
Programme Elective Courses	12
Open Elective	3
Total M.Tech. Credit Requirement	48
Grand Total Credit Requirement	188

Institute Core: Basic Sciences

CML101	Introduction to Chemistry	3	1	0	4
CMP100	Chemistry Laboratory	0	0	4	2
MTL100	Calculus	3	1	0	4
MTL101	Linear Algebra and Differential Equations	3	1	0	4
PYL101	Electromagnetism & Quantum Mechanics	3	1	0	4
PYP100	Physics Laboratory	0	0	4	2
SBL100	Introductory Biology for Engineers	3	0	2	4
Total Credits					24

Institute Core: Engineering Arts and Sciences

APL100	Engineering Mechanics	3	1	0	4
COL100	Introduction to Computer Science	3	0	2	4
CVL100	Environmental Science	2	0	0	2
ELL101	Introduction to Electrical Engineering	3	1	0	4
ELP101	Introduction to Electrical Engineering (Lab)	0	0	2	1
MCP100	Introduction to Engineering Visualization	0	0	4	2
MCP101	Product Realization through Manufacturing	0	0	4	2
Total Credits					19

Programme-Linked Basic/Engineering Arts/Sciences Core

MLL100	Introduction to Materials Science and Engineering*	3	0	2	4
CML103	Applied Chemistry - Chemistry at Interfaces	3	0	0	3
Total Credits					7

* APL102 is superseded by MLL100

Humanities and Social Sciences

Courses from Humanities, Social Sciences and Management offered under this category **15**

Departmental Core

CLL110	Transport Phenomena	3	1	0	4
CLL111	Material and Energy Balances	2	2	0	4
CLL113	Numerical Methods in Chemical Engineering	3	0	2	4
CLL121	Chemical Engineering Thermodynamics	3	1	0	4
CLL122	Chemical Reaction Engineering-I	3	1	0	4
CLL141	Introduction to Materials for Chemical Engineers	3	0	0	3
CLL222	Chemical Reaction Engineering-II	3	0	0	3
CLL231	Fluid Mechanics for Chemical Engineers	3	1	0	4
CLL251	Heat Transfer for Chemical Engineers	3	1	0	4
CLL252	Mass Transfer-I	3	0	0	3
CLL261	Process Dynamics and Control	3	1	0	4
CLL271	Introduction to Industrial Biotechnology	3	0	0	3
CLP301	Chemical Engineering Laboratory-I	0	0	3	1.5
CLP302	Chemical Engineering Laboratory-II	0	0	3	1.5
CLP303	Chemical Engineering Laboratory-III	0	0	3	1.5
CLL331	Fluid-Particle Mechanics	3	1	0	4
CLL352	Mass Transfer-II	3	1	0	4

CLL361	Instrumentation and Automation	1	0	3	2.5
CLL371	Chemical Process Technology and Economics	3	1	0	4
Total Credits					63

Departmental Electives

CLL133	Powder Processing and Technology	3	0	0	3
CLL296	Nano-engineering of Soft Materials	3	0	0	3
CLL390	Process Utilities and Pipeline Design	3	0	0	3
CLL402	Process Plant Design	3	0	0	3
CLL475	Safety and Hazards in Process Industries	3	0	0	3
CLL477	Materials of Construction	3	0	0	3
CLL705	Petroleum Reservoir Engineering	3	0	0	3
CLL706	Petroleum Production Engineering	3	0	0	3
CLL707	Population Balance Modeling	3	0	0	3
CLL720	Principles of Electrochemical Engineering	3	0	0	3
CLL721	Electrochemical Methods	3	0	0	3
CLL722	Electrochemical Conversion and Storage Devices	3	0	0	3
CLL723	Hydrogen Energy and Fuel Cell Technology	3	0	0	3
CLL724	Environmental Engineering and Waste Management	3	0	0	3
CLL725	Air Pollution Control Engineering	3	0	0	3
CLL726	Molecular Modeling of Catalytic Reactions	3	0	0	3
CLL727	Heterogeneous Catalysis and Catalytic Reactors	3	0	0	3
CLL728	Biomass Conversion and Utilization	3	0	0	3
CLL729	Colloids and Aerosols	3	0	0	3
CLL730	Structure, Transport and Reactions in BioNano Systems	3	0	0	3
CLL732	Advanced Chemical Engineering Thermodynamics	3	0	0	3
CLL734	Process Intensification and Novel Reactors	3	0	0	3
CLL735	Design of Multicomponent Separation Processes	3	0	0	3
CLL736	Experimental Characterization of Multiphase Reactors	3	0	0	3
CLL742	Experimental Characterization of BioMacromolecules	3	0	0	3
CLL743	Petrochemicals Technology	3	0	0	3
CLL760	Crystal Engineering and Design	3	0	0	3
CLL761	Chemical Engineering Mathematics	3	0	0	3
CLL762	Advanced Computational Techniques in Chemical Engineering	2	0	2	3
CLL766	Interfacial Engineering	3	0	0	3
CLL767	Structures and Properties of Polymers	3	0	0	3
CLL768	Fundamentals of Computational Fluid Dynamics	2	0	2	3
CLL769	Applications of Computational Fluid Dynamics	2	0	2	3
CLL771	Introduction to Complex Fluids	3	0	0	3
CLL772	Transport Phenomena in Complex Fluids	3	0	0	3
CLL773	Thermodynamics of Complex Fluids	3	0	0	3
CLL774	Simulation Techniques for Complex Fluids	3	0	0	3
CLL775	Polymerization Process Modeling	3	0	0	3
CLL776	Granular Materials	3	0	0	3
CLL777	Complex Fluids Technology	3	0	0	3
CLL778	Interfacial Behaviour and Transport of Biomolecules	3	0	0	3
CLL779	Molecular Biotechnology and in-vitro Diagnostics	3	0	0	3
CLL780	Bioprocessing and Bioseparations	3	0	0	3
CLL781	Process Operations Scheduling	3	0	0	3
CLL782	Process Optimization	3	0	0	3
CLL783	Advanced Process Control	3	0	0	3
CLL784	Process Modeling and Simulation	3	0	0	3
CLL785	Evolutionary Optimization	3	0	0	3
CLL786	Fine Chemicals Technology	3	0	0	3
CLL787	Statistical Methods for Chemical Engineering	3	0	0	3
CLL788	Process Data Analytics	3	0	0	3
CLL789	Applied Time Series Analysis for Chemical Engineering	3	0	0	3
CLL791	Chemical Product and Process Integration	3	0	0	3
CLL792	Chemical Product Development and Commercialization	3	0	0	3
CLL793	Membrane Science and Engineering	3	0	0	3
CLL794	Petroleum Refinery Engineering	3	0	0	3

CLV796	Current Topics in Chemical Engineering	1	0	0	1	CLL760	Crystal Engineering and Design	3	0	0	3
CLV797	Recent Advances in Chemical Engineering	2	0	0	2	CLL761	Chemical Engineering Mathematics	3	0	0	3
CLL798	Selected Topics in Chemical Engineering-I	3	0	0	3	CLL762	Advanced Computational Techniques in Chemical Engineering	2	0	2	3
CLL799	Selected Topics in Chemical Engineering-II	3	0	0	3	CLL766	Interfacial Engineering	3	0	0	3
Program Core											
CLL703	Process Engineering	3	0	0	3	CLL767	Structures and Properties of Polymers	3	0	0	3
CLL731	Advanced Transport Phenomena	3	0	0	3	CLL768	Fundamentals of Computational Fluid Dynamics	2	0	2	3
CLL733	Industrial Multiphase Reactors	3	0	0	3	CLL769	Applications of Computational Fluid Dynamics	2	0	2	3
CLD880	Minor Project	0	0	8	4	CLL771	Introduction to Complex Fluids	3	0	0	3
CLD881	Major Project Part-I	0	0	16	8	CLL772	Transport Phenomena in Complex Fluids	3	0	0	3
CLD882	Major Project Part-II	0	0	24	12	CLL773	Thermodynamics of Complex Fluids	3	0	0	3
	Total Credits				33	CLL774	Simulation Techniques for Complex Fluids	3	0	0	3
Program Electives											
CLL705	Petroleum Reservoir Engineering	3	0	0	3	CLL775	Polymerization Process Modeling	3	0	0	3
CLL706	Petroleum Production Engineering	3	0	0	3	CLL776	Granular Materials	3	0	0	3
CLL707	Population Balance Modeling	3	0	0	3	CLL777	Complex Fluids Technology	3	0	0	3
CLL720	Principles of Electrochemical Engineering	3	0	0	3	CLL778	Interfacial Behaviour and Transport of Biomolecules	3	0	0	3
CLL721	Electrochemical Methods	3	0	0	3	CLL779	Molecular Biotechnology and in-vitro Diagnostics	3	0	0	3
CLL722	Electrochemical Conversion and Storage Devices	3	0	0	3	CLL780	Bioprocessing and Bioseparations	3	0	0	3
CLL723	Hydrogen Energy and Fuel Cell Technology	3	0	0	3	CLL781	Process Operations Scheduling	3	0	0	3
CLL724	Environmental Engineering and Waste Management	3	0	0	3	CLL782	Process Optimization	3	0	0	3
CLL725	Air Pollution Control Engineering	3	0	0	3	CLL783	Advanced Process Control	3	0	0	3
CLL726	Molecular Modeling of Catalytic Reactions	3	0	0	3	CLL784	Process Modeling and Simulation	3	0	0	3
CLL727	Heterogeneous Catalysis and Catalytic Reactors	3	0	0	3	CLL785	Evolutionary Optimization	3	0	0	3
CLL728	Biomass Conversion and Utilization	3	0	0	3	CLL786	Fine Chemicals Technology	3	0	0	3
CLL729	Colloids and Aerosols	3	0	0	3	CLL787	Statistical Methods for Chemical Engineering	3	0	0	3
CLL730	Structure, Transport and Reactions in BioNano Systems	3	0	0	3	CLL788	Process Data Analytics	3	0	0	3
CLL732	Advanced Chemical Engineering Thermodynamics	3	0	0	3	CLL789	Applied Time Series Analysis for Chemical Engineering	3	0	0	3
CLL734	Process Intensification and Novel Reactors	3	0	0	3	CLL791	Chemical Product and Process Integration	3	0	0	3
CLL735	Design of Multicomponent Separation Processes	3	0	0	3	CLL792	Chemical Product Development and Commercialization	3	0	0	3
CLL736	Experimental Characterization of Multiphase Reactors	3	0	0	3	CLL793	Membrane Science and Engineering	3	0	0	3
CLL742	Experimental Characterization of BioMacromolecules	3	0	0	3	CLL794	Petroleum Refinery Engineering	3	0	0	3
CLL743	Petrochemicals Technology	3	0	0	3	CLV796	Current Topics in Chemical Engineering	1	0	0	1
						CLV797	Recent Advances in Chemical Engineering	2	0	0	2
						CLL798	Selected Topics in Chemical Engineering-I	3	0	0	3
						CLL799	Selected Topics in Chemical Engineering-II	3	0	0	3

Semester	Course-1	Course-2	Course-3	Course-4	Course-5	Course-6	Course-7	Course-8	Course-9	Course-10	L	T	P	Credits	Non-Graded Units	Contact Hours																
I	ELL101 Introduction to Electrical Engineering	ELP101 Introduction to Electrical Engineering (Lab.)	MCP100 Introduction to Engineering Visualization	PYL101 Electromagnetism & Quantum Mechanics	MTL100 Calculus	PYP100 Physics Laboratory	MCP101 Product Realization through Manufacturing	NIN100 Introduction to Engineering (Non-graded)	NEP100 Professional Ethics and Social Responsibility-1 (Non-graded)	NLN100 Language and Writing Skills-1 (Non-Graded)	9	0	3	14	19.0	2.5	31.0															
	APL100 Engineering Mechanics	COL100 Introduction to Computer Science	CML101 Introduction to Chemistry	MTL101 Linear Algebra and Differential Equations	CMP100 Chemistry Laboratory			NEP101 Professional Ethics and Social Responsibility-2 (Non-Graded)	NLN101 Language and Writing Skills-2 (Non-Graded)		9	0	3	14	19.0	2.5	31.0															
	3	1	0	4	3	1	0	4	0	0	2	1	0	0	0	2	1															
II	Note: Courses 1-6 above are attended in the given order by half of all first year students. The other half of first year students attend the Courses 1-6 of II semester first.																															
	3	1	0	4	3	1	0	4	0	0	4	2	0	0	1	0.5	0	2	1	12	3	6	18.0	1.5	24.0							
III	CLL110 Transport Phenomena	CLL111 Material and Energy Balances	CLL113 Numerical Methods in Chemical Engineering	CML103 Applied Chemistry: Chemistry at Interfaces	HUL2XX																											
	3	1	0	4	2	2	0	4	3	0	0	3	3	1	0	4																
	3	1	0	4	3	0	2	4	3	0	0	3	3	1	0	4																
IV	CLL121 Chemical Engineering Thermodynamics	CLL122 Chemical Reaction Engineering I	CLL231 Fluid Mechanics for Chemical Engineers	CLL251 Heat Transfer for Chemical Engineers	SBL100 Introductory Biology for Engineers	MLL100 Introduction to Materials Science and Engineering																										
	3	1	0	4	3	1	0	4	3	1	0	4	3	0	2	4																
	3	1	0	4	3	1	0	4	3	1	0	4	3	0	2	4																
V	CLL252 Mass Transfer I	CLL222 Chemical Reaction Engineering II	CLL331 Fluid-Particle Mechanics	CLL141 Introduction to Materials for Chemical Engineers	CLL261 Process Dynamics and Control	CVL100 Environmental Science	CLP301 Chemical Engineering Laboratory I																									
	3	0	0	3	3	0	0	3	3	1	0	4	2	0	0	2	0	0	3	1.5												
	3	0	0	3	3	0	0	3	3	0	0	3	3	1	0	4	2	0	0	3	1.5											
VI	CLL362 Mass Transfer II	DE 1	CLL271 Introduction to Industrial Biotechnology	CLL371 Chemical Process Technology and Economics	CLL361 Instrumentation and Automation	HUL2XX	CLP302 Chemical Engineering Laboratory II																									
	3	1	0	4	3	0	0	3	3	1	0	4	1	0	3	2.5	3	1	0	4	0	0	3	1.5								
	3	1	0	4	3	0	0	3	3	1	0	4	1	0	3	2.5	3	1	0	4	0	0	3	1.5								
VII	DE 2	PE 1	PE 2	CLP303 Chemical Engineering Laboratory III	CLL703 Process Engineering	HUL2XX	OC 1																									
	3	0	0	3	3	0	0	3	0	0	3	1.5	3	0	0	3	3	1	0	4	3	0	0	3								
	3	0	0	3	3	0	0	3	0	0	3	1.5	3	0	0	3	3	1	0	4	3	0	0	3								
VIII	PE 3	DE 3	CLD880 Minor Project	HUL3XX	CLL731 Adv Trans Pheno	CLL733 Ind Multiph Reac																										
	3	0	0	3	3	0	0	3	3	0	0	3	3	0	0	3	3	0	0	3	0	0	3									
	3	0	0	3	3	0	0	3	3	0	0	3	3	0	0	3	3	0	0	3	0	0	3									
Summer																																
	CLD881 Major Project I	PE 4	OE 1																													
	0	0	16	8	3	0	0	3	3	0	0	3	3	0	0	3	6	0	16	14.0	0											
IX	CLD882 Major Project II																															
	0	0	24	12																												
	0	0	24	12																												
X																																
	0	0	24	12																												
	0	0	24	12																												
																TOTAL=188.0																

Bachelor of Technology in Civil Engineering

Department of Civil Engineering

The overall Credit Structure

Course Category	Credits
Institute Core Courses	
Basic Sciences (BS)	24
Engineering Arts and Science (EAS)	19
Humanities and Social Sciences (HuSS)	15
Programme-linked Courses	10
Departmental Courses	
Departmental Core	66
Departmental Electives	14
Open Category Courses	10
Total Graded Credit requirement	158
Non Graded Units	11

Institute Core: Basic Sciences

Course Code	Course Name	Credits
CML101	Introduction to Chemistry	3 1 0 4
CMP100	Chemistry Laboratory	0 0 4 2
MTL100	Calculus	3 1 0 4
MTL101	Linear Algebra and Differential Equations	3 1 0 4
PYL101	Electromagnetism & Quantum Mechanics	3 1 0 4
PYP100	Physics Laboratory	0 0 4 2
SBL100	Introductory Biology for Engineers	3 0 2 4
Total Credits		24

Institute Core: Engineering Arts and Sciences

Course Code	Course Name	Credits
APL100	Engineering Mechanics	3 1 0 4
COL100	Introduction to Computer Science	3 0 2 4
CVL100	Environmental Science	2 0 0 2
ELL101	Introduction to Electrical Engineering	3 1 0 4
ELP101	Introduction to Electrical Engineering (Lab)	0 0 2 1
MCP100	Introduction to Engineering Visualization	0 0 4 2
MCP101	Product Realization through Manufacturing	0 0 4 2
Total Credits		19

Programme-Linked Basic/Engineering Arts/Sciences Core

Course Code	Course Name	Credits
APL 107	Mechanics of Fluids	3 1 2 5
APL 108	Mechanics of Solids	3 1 2 5
Total Credits		10

Humanities and Social Sciences

Courses from Humanities, Social Sciences and Management offered under this category	15
---	-----------

Departmental Core

Course Code	Course Name	Credits
CVL111	Elements of Surveying	3 0 2 4
CVL121	Engineering Geology	3 0 0 3
CVP121	Engineering Geology Lab	0 0 2 1
CVL141	Civil Engineering Materials	3 0 0 3
CVL212	Environmental Engineering	3 0 2 4
CVL222	Soil Mechanics	3 0 0 3
CVP222	Soil Mechanics Lab	0 0 2 1
CVL242	Structural Analysis-I	3 0 0 3
CVP242	Structural Analysis Lab	0 0 2 1
CVL243	RC Design	3 0 0 3
CVP243	Structures & Material (Concrete) Lab	0 0 3 1.5
CVL244	Construction Practices	2 0 0 2
CVL245	Construction Management	2 0 0 2
CVL261	Introduction to Transportation Engineering	3 0 0 3
CVP261	Transportation Engineering Lab	0 0 2 1
CVL281	Hydraulics	3 1 0 4
CVP281	Hydraulics Lab	0 0 2 1
CVL282	Engineering Hydrology	3 0 2 4
CVL321	Geotechnical Engineering	3 1 0 4
CVP321	Geotechnical Engineering Lab	0 0 2 1
CVL341	Structural Analysis-II	3 0 0 3
CVL342	Steel Design	3 0 0 3
CVP342	Structures & Material (Steel) Lab	0 0 2 1
CVL381	Design of Hydraulic Structures	3 0 2 4
CVD411	B.Tech. Project Part-I	0 0 8 4
CVP441	Structural Design & Detailing	0 0 3 1.5
Total Credits		66

Departmental Electives

Course Code	Course Name	Credits
CVL284	Fundamentals of Geographic Information Systems	2 0 2 3
CVL311	Industrial Waste Management	3 0 0 3
CVL312	Environmental Assessment Methodologies	3 0 0 3
CVL313	Air and Noise Pollution	3 0 0 3
CVL344	Construction Project Management	3 0 0 3
CVL361	Introduction to Railway Engineering	3 0 0 3
CVL382	Groundwater	2 0 0 2
CVL383	Water Resources Systems	2 0 0 2
CVL384	Urban Hydrology	2 0 0 2
CVL385	Frequency Analysis in Hydrology	2 0 0 2
CVL386	Fundamentals of Remote Sensing	2 0 2 3
CVD412	B.Tech. Project Part-II	0 0 12 6
CVL421	Ground Engineering	3 0 0 3
CVL422	Rock Engineering	3 0 0 3
CVL423	Soil Dynamics	3 0 0 3
CVL424	Environmental Geotechniques & Geosyntheses	3 0 0 3
CVL431	Design of Foundations & Retaining Structures	3 0 0 3
CVL432	Stability of Slopes	2 0 0 2
CVL433	FEM in Geotechnical Engineering	3 0 0 3
CVP434	Geotechnical Design Studio	0 0 4 2
CVL435	Underground Structures	2 0 0 2
CVL441	Structural Design	3 0 0 3
CVL442	Structural Analysis-III	3 0 0 3
CVL443	Prestressed Concrete & Industrial Structures	3 0 0 3
CVL461	Logistics and Freight Transport	3 0 0 3
CVL462	Introduction to Intelligent Transportation Systems	3 0 0 3
CVL481	Water Resources Management	3 0 0 3
CVL482	Water Power Engineering	2 0 2 3
CVL483	Groundwater & Surface-water Pollution	2 0 0 2
CVP484	Computational Aspects in Water Resources	1 0 4 3
CVL485	River Mechanics	2 0 2 3
CVL486	Geo-informatics	2 0 2 3
CVL721	Solid Waste Engineering	3 0 0 3
CVL724	Environmental systems analysis	3 0 0 3
CVL727	Environmental risk assessment	3 0 0 3
CVL728	Environmental Quality Modeling	3 0 0 3
CVL740	Pavement Materials and Design of Pavements	3 0 2 4
CVL741	Urban and Regional Transportation Planning	3 0 2 4
CVL742	Traffic Engineering	3 0 2 4
CVL743	Airport Planning and Design	3 0 0 3
CVL744	Transportation Infrastructure Design	2 0 2 3
CVL746	Public Transportation Systems	3 0 0 3
CVL763	Analytical and Numerical Methods for Structural Engineering	3 0 0 3
CVL765	Concrete Mechanics	3 0 0 3
CVL766	Design of Bridge Structures	3 0 0 3
CVL768	Design of Masonry Structures	3 0 0 3
CVL769	Design of Tall Buildings	3 0 0 3
CVL770	Prestressed and Composite Structures	3 0 0 3
CVL771	Advanced Concrete Technology	3 0 0 3
CVL820	Environmental impact assessment	3 0 0 3
CVL822	Emerging Technologies for Environmental Management	3 0 0 3
CVL823	Thermal Techniques for Waste Management	3 0 0 3
CVL824	Life Cycle Analysis and Design for Environment	3 0 0 3
CVL837	Mechanics of Sediment Transport	2 0 2 3
CVL841	Advanced Transportation Modelling	2 0 2 3
CVL842	Geometric Design of Roads	2 0 2 3
CVL847	Transportation Economics	3 0 0 3
CVL857	Structural Safety and Reliability	3 0 0 3
CVL858	Theory of Plates and Shells	3 0 0 3
CVL859	Theory of Structural Stability	3 0 0 3
CVL862	Design of Offshore Structures	3 0 0 3
CVL866	Wind Resistant Design of Structures	3 0 0 3

Semester	Course-1	Course-2	Course-3	Course-4	Course-5	Course-6	Course-7	Course-8	Course-9	Course-10	L	T	P	Credits	Non-Graded Units	Contact Hours																									
I	ELL101 Introduction to Electrical Engineering	ELPT101 Introduction to Electrical Engineering (Lab.)	MCP100 Introduction to Engineering Visualization	PYL101 Electromagnetism & Quantum Mechanics	MTL100 Calculus	PYP100 Physics Laboratory	MCP101 Product Realization through Manufacturing	NIN100 Introduction to Engineering (Non-graded)	NEW100 Professional Ethics and Social Responsibility-1 (Non-graded)	NLN100 Language and Writing Skills-1 (Non-Graded)	3	1	0	4	0	0	0	2	1	9	0	0	2	1	19.0	2.5	31.0														
	APL100 Engineering Mechanics	COL100 Introduction to Computer Science	CML101 Introduction to Chemistry	MTL101 Linear Algebra and Differential Equations	CMP100 Chemistry Laboratory			NEW101 Professional Ethics and Social Responsibility-2 (Non-graded)	NLN101 Language and Writing Skills-2 (Non-Graded)			3	1	0	4	0	0	2	1	9	0	0	2	1																	
	3	1	0	4	3	1	0	4	3	1	0	4	0	0	4	2	0	0	2	1	12	3	6	18.0	1.5	24.0															
II	CVL111 Elements of Surveying	CVL121+CVP121 Engineering Geology + Lab	CVL141 Civil Engineering Materials	APL107 Mechanics of Fluids	APL108 Mechanics of Solids	HUL2XX																																			
	3	0	2	4	3	0	0	3	3	1	2	5	3	1	0	4						18	3	8	25.0	0	29.0														
	CVL222 + CVP222 Soil Mechanics + Lab	CVL242 + CVP242 Structural Analysis I + Lab	CVL261 + CVP261 Intro. to Transportation Engg + Lab	CVL281 + CVP281 Hydraulics + Lab	CVL100 Environmental Science	HUL2XX																																			
3	0	2	4	3	0	2	4	3	1	2	5	2	0	0	2	3	1	0	4			17	2	8	23.0	0	27.0														
IV	CVL243 + CVP243 RC Design + Lab	CVL245 Construction Management	CVL282 Engineering Hydrology	CVL321 + CVP321 Geotechnical Engineering + Lab	CVL341 Structural Analysis II for Engineers	SBL100 Introductory Biology																																			
	3	0	3	4.5	2	0	0	2	3	1	2	5	3	0	0	3	3	0	2	4			17	1	9	22.5	0	27.0													
	CVL212 Environmental Engineering	CVL244 Construction Practices	CVL342 + CVP342 Steel Design + Lab	CVL381 Design of Hydraulic Structures	OC 1	HUL2XX																																			
3	0	2	4	2	0	0	2	3	0	2	4	3	0	0	3	3	1	0	4			17	1	6	21.0	0	24.0														
VI	DE 1	DE 2	DE 3 / OC 2		CVP441 Structural Design and Detailing	HUL3XX	CVD411 B.Tech. Project I																																		
	2	0	2	3	2	0	0	2	0	0	3	1.5	3	0	0	3	0	0	3	0	0	3	0	0	8	4	10	0	13	16.5	0	23.0									
	DE 4	DE 5	OC 2 / DE 3	OC 3																																					
2	0	2	3	3	0	0	3	3	1	0	4																														
VIII																																									
	2	0	2	3	3	0	0	3	3	1	0	4																													
	2	0	2	3	3	0	0	3	3	1	0	4																													
TOTAL=158.0																																									

Bachelor of Technology in Computer Science and Engineering

Department of Computer Science and Engineering

The overall Credit Structure

Course Category	Credits
Institute Core Courses	
Basic Sciences (BS)	24
Engineering Arts and Science (EAS)	19
Humanities and Social Sciences (HuSS)	15
Programme-linked Courses	14
Departmental Courses	
Departmental Core	55
Departmental Electives	11
Open Category Courses	10
Total Graded Credit requirement	148
Non Graded Units	11

Institute Core: Basic Sciences

CML101	Introduction to Chemistry	3	1	0	4
CMP100	Chemistry Laboratory	0	0	4	2
MTL100	Calculus	3	1	0	4
MTL101	Linear Algebra and Differential Equations	3	1	0	4
PYL101	Electromagnetism & Quantum Mechanics	3	1	0	4
PYP100	Physics Laboratory	0	0	4	2
SBL100	Introductory Biology for Engineers	3	0	2	4
Total Credits					24

Institute Core: Engineering Arts and Sciences

APL100	Engineering Mechanics	3	1	0	4
CVL100	Environmental Science	2	0	0	2
COL100	Introduction to Computer Science	3	0	2	4
ELL101	Introduction to Electrical Engineering	3	1	0	4
ELP101	Introduction to Electrical Engineering (Lab)	0	0	2	1
MCP100	Introduction to Engineering Visualization	0	0	4	2
MCP101	Product Realization through Manufacturing	0	0	4	2
Total Credits					19

Programme-Linked Basic/Engineering Arts/Sciences Core

ELL205	Signals and Systems	3	1	0	4
MTL103*	Optimization Methods and Applications	3	0	0	3
MTL104*	Linear Algebra and Applications	3	0	0	3
MTL105*	Algebra	3	0	0	3
MTL106	Probability and Stochastic Processes	3	1	0	4
PYL102#	Principles of Electronic Materials	3	0	0	3
PYL103#	Physics of Nanomaterials	3	0	0	3
Total Credits					14

* One of these three courses

One of these two courses

Humanities and Social Sciences

Courses from Humanities, Social Sciences and Management offered under this category **15**

Departmental Core

COL106	Data Structures and Algorithms	3	0	4	5
COL202	Discrete Mathematical Structures	3	1	0	4
COL215	Digital Logic and System Design	3	0	4	5
COL216	Computer Architecture	3	0	2	4
COL226	Programming Languages	3	0	4	5
COP290	Design Practices	0	0	6	3
COL331	Operating Systems	3	0	4	5
COL333	Principles of Artificial Intelligence*	3	0	2	4
COL334	Computer Networks	3	0	2	4
COL351	Analysis and Design of Algorithms	3	1	0	4
COL352	Introduction to Automata and Theory of Computation	3	0	0	3
COL362	Introduction to Database Management Systems*	3	0	2	4
COL380	Introduction to Parallel and Distributed Programming	2	0	2	3
COD490	B.Tech. Project	0	0	12	6
COD492	B.Tech. Project Part-I	0	0	12	6
Total Credits					55

Departmental Electives

COD300	Design Project	0	0	4	2
COD310	Mini Project	0	0	6	3
COL333	Principles of Artificial Intelligence*	3	0	2	4
COL341	Machine Learning	3	0	2	4
COL362	Introduction to Database Management Systems*	3	0	2	4
COP315	Embedded System Design Project	0	1	6	4
COD494**	B.Tech. Project Part-II	0	0	16	8
COR310	Professional Practices (CS)	1	0	2	2
COS310	Independent Study (CS)	0	3	0	3
COL703***	Logic for Computer Science	3	0	2	4

COL718	Architecture of High Performance Computers	3	0	2	4
COL719	Synthesis of Digital Systems	3	0	2	4
COL720	Real Time Systems	3	0	2	4
COL722	Introduction to Compressed Sensing	3	0	0	3
COL724	Advanced Computer Networks	3	0	2	4
COL726	Numerical Algorithms	3	0	2	4
COL728	Compiler Design	3	0	3	4.5
COL729	Compiler Optimization	3	0	3	4.5
COL730	Parallel Programming	3	0	2	4
COL732	Virtualization and Cloud Computing	3	0	2	4
COL733	Cloud Computing Technology Fundamentals	3	0	2	4
COL740	Software Engineering	3	0	2	4
COL750	Foundations of Automatic Verification	3	0	2	4
COL751	Algorithmic Graph Theory	3	0	0	3
COL752	Geometric Algorithms	3	0	2	4
COL753	Complexity Theory	3	0	0	3
COL754	Approximation Algorithms	3	0	0	3
COL756	Mathematical Programming	3	0	0	3
COL757	Model Centric Algorithm Design	3	0	2	4
COL758	Advanced Algorithms	3	0	2	4
COL759	Cryptography & Computer Security	3	0	0	3
COL760	Advanced Data Management	3	0	2	4
COL761	Data Mining	3	0	2	4
COL762	Database Implementation	3	0	2	4
COL764	Information Retrieval and Web Search	3	0	2	4
COL765	Logic and Functional Programming	3	0	2	4
COL768	Wireless Networks	3	0	2	4
COL770	Advanced Artificial Intelligence	3	0	2	4
COL772	Natural Language Processing	3	0	2	4
COL774	Machine Learning	3	0	2	4
COL776	Learning Probabilistic Graphical Models	3	0	2	4
COL780	Computer Vision	3	0	2	4
COL781	Computer Graphics	3	0	3	4.5
COL783	Digital Image Analysis	3	0	3	4.5
COL786	Advanced Functional Brain Imaging	3	0	2	4
COL788	Advanced Topics in Embedded Computing	3	0	0	3
COL860	Special Topics in Parallel Computation	3	0	0	3
COL861	Special Topics in Hardware Systems	3	0	0	3
COL862	Special Topics in Software Systems	3	0	0	3
COL863	Special Topics in Theoretical Computer Science	3	0	0	3
COL864	Special Topics in Artificial Intelligence	3	0	0	3
COL865	Special Topics in Computer Applications	3	0	0	3
COL866	Special Topics in Algorithms	3	0	0	3
COL867	Special Topics in High Speed Networks	3	0	0	3
COL868	Special Topics in Database Systems	3	0	0	3
COL869	Special Topics in Concurrency	3	0	0	3
COL870	Special Topics in Machine Learning	3	0	0	3
COL871	Special Topics in Programming Languages	3	0	0	3
COL872	Special Topics in Cryptography	3	0	0	3
COL873	Special Topics in Natural Language Processing	3	0	0	3
COL874	Special Topics in Compilers and Language Implementation	3	0	0	3
COL876	Special Topics in Formal Methods	3	0	0	3
COL886	Special Topics in Operating Systems	3	0	0	3
COV877	Special Module on Visual Computing	1	0	0	1
COV878	Special Module in Machine Learning	1	0	0	1
COV879	Special Module in Financial Algorithms	2	0	0	2
COV880	Special Module in Parallel Computation	1	0	0	1
COV881	Special Module in Hardware Systems	1	0	0	1
COV882	Special Module in Software Systems	1	0	0	1
COV883	Special Module in Theoretical Computer Science	1	0	0	1
COV884	Special Module in Artificial Intelligence	1	0	0	1
COV885	Special Module in Computer Applications	1	0	0	1
COV886	Special Module in Algorithms	1	0	0	1
COV887	Special Module in High Speed Networks	1	0	0	1
COV888	Special Module in Database Systems	1	0	0	1
COV889	Special Module in Concurrency	1	0	0	1
SIL765	Networks & System Security	3	0	2	4
SIL769	Internet Traffic - Measurement, Modeling & Analysis	3	0	2	4
SIL801	Special Topics in Multimedia System	3	0	0	3
SIL802	Special Topics in Web Based Computing	3	0	0	3
SIV813	Applications of Computer in Medicines	1	0	0	1
SIV861	Information and Comm Technologies for Development	1	0	0	1
SIV864	Special Module on Media Processing & Communication	1	0	0	1
SIV895	Special Module on Intelligent Information Processing	1	0	0	1

* One of COL333 or COL362 will be considered as DC and other will be considered as DE

** DC for CS1 students with specialization, DE for other CS1 students but with at most 4 credits counted towards DE.

*** DC for CS1 students with specialization.

Semester	Course-1	Course-2	Course-3	Course-4	Course-5	Course-6	Course-7	Course-8	Course-9	Course-10	L	T	P	Credits	Non-Graded Units	Contact Hours
I	ELL101 Introduction to Electrical Engineering	ELP101 Introduction to Electrical Engineering (Lab.)	MCP100 Introduction to Engineering Visualization	PYL101 Electromagnetism & Quantum Mechanics	MTL100 Calculus	PYP100 Physics Laboratory	MCP101 Product Realization through Manufacturing	NIN100 Introduction to Engineering (Non-graded)	NEI100 Professional Ethics and Social Responsibility-1 (Non-graded)	NLN100 Language and Writing Skills-1 (Non-Graded)	9.0	3	14	19.0	2.5	31.0
	APL100 Engineering Mechanics	COL100 Introduction to Computer Science	CML101 Introduction to Chemistry	MTL101 Linear Algebra and Differential Equations	CMP100 Chemistry Laboratory			NEI101 Professional Ethics and Social Responsibility-2 (Non-graded)	NLN101 Language and Writing Skills-2 (Non-Graded)		9.0	3	14	19.0	2.5	31.0
II	3 1 0 4	3 0 2 4	3 1 0 4	3 1 0 4	0 0 4 2	0 0 4 2	0 0 4 2	0 0 1 0.5	0 0 2 1	0 0 2 1	12	3	6	18.0	1.5	24.0
<p>Note: Courses 1-6 above are attended in the given order by half of all first year students. The other half of First year students attend the Courses 1-6 of II semester first.</p>																
III	COL202 Discrete Mathematical Structures	COL215 Digital Logic & System Design	COL106 Data Structures & Algorithms	PYL102 Principles of Electronic Materials	MTL106 Probability and Stochastic Processes											
	COL226 Programming Languages	COL216 Computer Architecture	ELL205 Signals and Systems	CVL100 Environmental Science	HUL2XX Design Practices	COP290 Design Practices					15	2	8	21.0	0	25.0
IV	3 0 4 5	3 0 2 4	3 1 0 4	2 0 0 2	3 1 0 4	0 0 6 3					14	2	12	22.0	0	28.0
V	COL333 / DE 1 Principles of Artificial Intelligence*	COL334 Computer Networks	COL351 Analysis and Design of Algorithms	SBL100 Introductory Biology for Engineers	HUL2XX Design Project (Non-Graded)	COD3XX Design Project (Non-Graded)										
	3 0 2 4	3 0 2 4	3 1 0 4	3 0 2 4	3 1 0 4	0 0 4 0					15	2	6	20.0	2	27.0
VI	COL362 / DE1 Introduction to Database Management Systems*	COL331 Operating Systems	COL352 Intro to Automata & Theory of Computation	MTLXXX Programme-Linked course in Mathematics	HUL2XX Intro to Parallel & Distributed Programming	COL380 Intro to Parallel & Distributed Programming										
VII	DE 2 (3)	OC 1 (3)	COL490/492 B.Tech Project part - I								17	1	8	22.0	0	26.0
	3 0 0 3	3 0 0 3	0 0 12 6								6	0	12	12.0	0	18.0
VIII	OC 2 (4)	OC 3 (3)	DE 3 (4)	HUL3XX												
	3 1 0 4	3 0 0 3	3 0 2 4	3 0 0 3							12	1	2	14.0	0	15.0
																TOTAL=148.0

Dual Degree Programme: Bachelor of Technology and Master of Technology in Computer Science and Engineering

Department of Computer Science and Engineering

The overall Credit Structure

Course Category	Credits
Institute Core Courses	
Basic Sciences (BS)	24
Engineering Arts and Science (EAS)	19
Humanities and Social Sciences (HuSS)	15
Programme-linked Courses	14
Departmental Courses	
Departmental Core	49
Departmental Electives	11
Open Category Courses	10
Total B.Tech. Credit Requirement	142
Non Graded Units	11
M. Tech. Part	
Programme Core Courses	32
Programme Elective Courses	14
Total M.Tech. Credit Requirement	46
Grand Total Credit Requirement	188

Institute Core: Basic Sciences

CML101	Introduction to Chemistry	3	1	0	4
CMP100	Chemistry Laboratory	0	0	4	2
MTL100	Calculus	3	1	0	4
MTL101	Linear Algebra and Differential Equations	3	1	0	4
PYL101	Electromagnetism & Quantum Mechanics	3	1	0	4
PYP100	Physics Laboratory	0	0	4	2
SBL100	Introductory Biology for Engineers	3	0	2	4
Total Credits					24

Institute Core: Engineering Arts and Sciences

APL100	Engineering Mechanics	3	1	0	4
COL100	Introduction to Computer Science	3	0	2	4
CVL100	Environmental Science	2	0	0	2
ELL101	Introduction to Electrical Engineering	3	1	0	4
ELP101	Introduction to Electrical Engineering (Lab)	0	0	2	1
MCP100	Introduction to Engineering Visualization	0	0	4	2
MCP101	Product Realization through Manufacturing	0	0	4	2
Total Credits					19

Programme-Linked Basic/Engineering Arts/Sciences Core

ELL205	Signals and Systems	3	1	0	4
MTL103*	Optimization Methods and Applications	3	0	0	3
MTL104*	Linear Algebra and Applications	3	0	0	3
MTL105*	Algebra	3	0	0	3
MTL106	Probability and Stochastic Processes	3	1	0	4
PYL102#	Principles of Electronic Materials	3	0	0	3
PYL103#	Physics of Nanomaterials	3	0	0	3
Total Credits					14

*One of these three courses

one of these two courses

Humanities and Social Sciences

Courses from Humanities, Social Sciences and Management offered under this category	15
---	-----------

Departmental Core

COL106	Data Structures and Algorithms	3	0	4	5
COL202	Discrete Mathematical Structures	3	1	0	4
COL215	Digital Logic and System Design	3	0	4	5
COL216	Computer Architecture	3	0	2	4
COL226	Programming Languages	3	0	4	5
COP290	Design Practices	0	0	6	3
COL331	Operating Systems	3	0	4	5
COL333	Principles of Artificial Intelligence*	3	0	2	4
COL334	Computer Networks	3	0	2	4
COL351	Analysis and Design of Algorithms	3	1	0	4
COL352	Introduction to Automata and Theory of Computation	3	0	0	3
COL380	Introduction to Parallel and Distributed Programming	2	0	2	3
Total Credits					49

Departmental Electives

COD300	Design Project	0	0	4	2
COD310	Mini Project	0	0	6	3
COL333	Principles of Artificial Intelligence*	3	0	2	4
COL341	Machine Learning	3	0	2	4
COL362	Introduction to Database Management Systems*	3	0	2	4
COP315	Embedded System Design Project	0	1	6	4
COR310	Professional Practices (CS)	1	0	2	2
COS310	Independent Study (CS)	0	3	0	3
COL718	Architecture of High Performance Computers	3	0	2	4
COL719	Synthesis of Digital Systems	3	0	2	4
COL720	Real Time Systems	3	0	2	4
COL722	Introduction to Compressed Sensing	3	0	0	3
COL724	Advanced Computer Networks	3	0	2	4
COL728	Compiler Design	3	0	3	4.5
COL729	Compiler Optimization	3	0	3	4.5
COL730	Parallel Programming	3	0	2	4
COL732	Virtualization and Cloud Computing	3	0	2	4
COL733	Cloud Computing Technology Fundamentals	3	0	2	4
COL740	Software Engineering	3	0	2	4
COL750	Foundations of Automatic Verification	3	0	2	4
COL751	Algorithmic Graph Theory	3	0	0	3
COL752	Geometric Algorithms	3	0	2	4
COL753	Complexity Theory	3	0	0	3
COL754	Approximation Algorithms	3	0	0	3
COL756	Mathematical Programming	3	0	0	3
COL757	Model Centric Algorithm Design	3	0	2	4
COL758	Advanced Algorithms	3	0	2	4
COL759	Cryptography & Computer Security	3	0	0	3
COL760	Advanced Data Management	3	0	2	4
COL761	Data Mining	3	0	2	4
COL762	Database Implementation	3	0	2	4
COL764	Information Retrieval and Web Search	3	0	2	4
COL765	Logic and Functional Programming	3	0	2	4
COL768	Wireless Networks	3	0	2	4
COL770	Advanced Artificial Intelligence	3	0	2	4
COL772	Natural Language Processing	3	0	2	4
COL774	Machine Learning	3	0	2	4
COL776	Learning Probabilistic Graphical Models	3	0	2	4
COL780	Computer Vision	3	0	2	4
COL781	Computer Graphics	3	0	3	4.5
COL783	Digital Image Analysis	3	0	3	4.5
COL786	Advanced Functional Brain Imaging	3	0	2	4
COL788	Advanced Topics in Embedded Computing	3	0	0	3
COL829	Advanced Computer Graphics	3	0	2	4
COL851	Special Topics in Operating Systems	3	0	0	3
COL852	Special Topics in Compiler Design	3	0	0	4
COL860	Special Topics in Parallel Computation	3	0	0	3
COL861	Special Topics in Hardware Systems	3	0	0	3
COL862	Special Topics in Software Systems	3	0	0	3
COL863	Special Topics in Theoretical Computer Science	3	0	0	3
COL864	Special Topics in Artificial Intelligence	3	0	0	3
COL865	Special Topics in Computer Applications	3	0	0	3
COL866	Special Topics in Algorithms	3	0	0	3
COL867	Special Topics in High Speed Networks	3	0	0	3
COL868	Special Topics in Database Systems	3	0	0	3
COL869	Special Topics in Concurrency	3	0	0	3
COL870	Special Topics in Machine Learning	3	0	0	3
COL871	Special Topics in Programming Languages	3	0	0	3
COL872	Special Topics in Cryptography	3	0	0	3
COL873	Special Topics in Natural Language Processing	3	0	0	3
COL874	Special Topics in Compilers and Language Implementation	3	0	0	3
COL876	Special Topics in Formal Methods	3	0	0	3
COV877	Special Module on Visual Computing	1	0	0	1
COV878	Special Module in Machine Learning	1	0	0	1
COV879	Special Module in Financial Algorithms	2	0	0	2
COV880	Special Module in Parallel Computation	1	0	0	1

COV881	Special Module in Hardware Systems	1	0	0	1	COL781	Computer Graphics	3	0	3	4.5	
COV882	Special Module in Software Systems	1	0	0	1	COL783	Digital Image Analysis	3	0	3	4.5	
COV883	Special Module in Theoretical Computer Science	1	0	0	1	COL788	Advanced Topics in Embedded Computing	3	0	0	3	
COV884	Special Module in Artificial Intelligence	1	0	0	1	COS799	Independent Study	0	3	0	3	
COV885	Special Module in Computer Applications	1	0	0	1	COL812	System Level Design and Modelling	3	0	0	3	
COV886	Special Module in Algorithms	1	0	0	1	COL818	Principles of Multiprocessor Systems	3	0	2	4	
COV887	Special Module in High Speed Networks	1	0	0	1	COL819	Advanced Distributed Systems	3	0	2	4	
COV888	Special Module in Database Systems	1	0	0	1	COL821	Reconfigurable Computing	3	0	0	3	
COV889	Special Module in Concurrency	1	0	0	1	COL830	Distributed Computing	3	0	0	3	
SIL765	Networks & System Security	3	0	2	4	COL831	Semantics of Programming Languages	3	0	0	3	
SIL769	Internet Traffic -Measurement, Modeling & Analysis	3	0	2	4	COL832	Proofs and Types	3	0	0	3	
SIL801	Special Topics in Multimedia System	3	0	0	3	COL859	Advanced Computer Graphics	3	0	2	4	
SIL802	Special Topics in Web Based Computing	3	0	0	3	COL860	Special Topics in Parallel Computation	3	0	0	3	
SIV813	Applications of Computer in Medicines	1	0	0	1	COL861	Special Topics in Hardware Systems	3	0	0	3	
SIV861	Information and Comm Technologies for Development	1	0	0	1	COL862	Special Topics in Software Systems	3	0	0	3	
SIV864	Special Module on Media Processing & Communication	1	0	0	1	COL863	Special Topics in Theoretical Computer Science	3	0	0	3	
SIV895	Special Module on Intelligent Information Processing	1	0	0	1	COL864	Special Topics in Artificial Intelligence	3	0	0	3	
Program Core						COL865	Special Topics in Computer Applications	3	0	0	3	
COL703	Logic for Computer Science	3	0	2	4	COL866	Special Topics in Algorithms	3	0	0	3	
COL726	Numerical Algorithms	3	0	2	4	COL867	Special Topics in High Speed Networks	3	0	0	3	
COD891	Minor Project	0	0	6	3	COL868	Special Topics in Database Systems	3	0	0	3	
COD892	M.Tech. Project Part-I	0	0	14	7	COL869	Special Topics in Concurrency	3	0	0	3	
COD893	M.Tech. Project Part-II	0	0	28	14	COL870	Special Topics in Machine Learning	3	0	0	3	
Total Credits						32	COL871	Special Topics in Programming Languages	3	0	0	3
Program Electives						COL872	Special Topics in Cryptography	3	0	0	3	
COD745	Minor Project	0	0	6	3	COL873	Special Topics in Natural Language Processing	3	0	0	3	
COL718	Architecture of High Performance Computers	3	0	2	4	COL874	Special Topics in Compilers and Language Implementation	3	0	0	3	
COL719	Synthesis of Digital Systems	3	0	2	4	COL876	Special Topics in Formal Methods	3	0	0	3	
COL720	Real Time Systems	3	0	2	4	COL886	Special Topics in Operating Systems	3	0	0	3	
COL724	Advanced Computer Networks	3	0	2	4	COV877	Special Module on Visual Computing	1	0	0	1	
COL728	Compiler Design	3	0	3	4.5	COV878	Special Module in Machine Learning	1	0	0	1	
COL729	Compiler Optimization	3	0	3	4.5	COV879	Special Module in Financial Algorithms	2	0	0	2	
COL730	Parallel Programming	3	0	2	4	COV880	Special Module in Parallel Computation	1	0	0	1	
COL732	Virtualization and Cloud Computing	3	0	2	4	COV881	Special Module in Hardware Systems	1	0	0	1	
COL740	Software Engineering	3	0	2	4	COV882	Special Module in Software Systems	1	0	0	1	
COL750	Foundations of Automatic Verification	3	0	2	4	COV883	Special Module in Theoretical Computer Science	1	0	0	1	
COL751	Algorithmic Graph Theory	3	0	0	3	COV884	Special Module in Artificial Intelligence	1	0	0	1	
COL752	Geometric Algorithms	3	0	2	4	COV885	Special Module in Computer Applications	1	0	0	1	
COL753	Complexity Theory	3	0	0	3	COV886	Special Module in Algorithms	1	0	0	1	
COL754	Approximation Algorithms	3	0	0	3	COV887	Special Module in High Speed Networks	1	0	0	1	
COL756	Mathematical Programming	3	0	0	3	COV888	Special Module in Database Systems	1	0	0	1	
COL757	Model Centric Algorithm Design	3	0	2	4	COV889	Special Module in Concurrency	1	0	0	1	
COL758	Advanced Algorithms	3	0	2	4	SIL765	Networks & System Security	3	0	2	4	
COL759	Cryptography & Computer Security	3	0	0	3	SIL769	Internet Traffic -Measurement, Modeling & Analysis	3	0	2	4	
COL760	Advanced Data Management	3	0	2	4	SIL801	Special Topics in Multimedia System	3	0	0	3	
COL762	Database Implementation	3	0	2	4	SIL802	Special Topics in Web Based Computing	3	0	0	3	
COL764	Information Retrieval and Web Search	3	0	2	4	SIV813	Applications of Computer in Medicines	1	0	0	1	
COL768	Wireless Networks	3	0	2	4	SIV861	Information and Comm Technologies for Development	1	0	0	1	
COL770	Advanced Artificial Intelligence	3	0	2	4	SIV864	Special Module on Media Processing & Communication	1	0	0	1	
COL772	Natural Language Processing	3	0	2	4	SIV871	Special Module in Computational Neuroscience	1	0	0	1	
COL774	Machine Learning	3	0	2	4	SIV895	Special Module on Intelligent Information Processing	1	0	0	1	
COL776	Learning Probabilistic Graphical Models	3	0	2	4							
COL780	Computer Vision	3	0	2	4							

Semester	Course-1	Course-2	Course-3	Course-4	Course-5	Course-6	Course-7	Course-8	Course-9	Course-10	L	T	P	Credits	Non-Graded Units	Contact Hours
I	ELL101 Introduction to Electrical Engineering	ELP101 Introduction to Electrical Engineering (Lab.)	MCP100 Introduction to Engineering Visualization	PYL101 Electromagnetism & Quantum Mechanics	MTL100 Calculus	PYP100 Physics Laboratory	MCP101 Product Realization through Manufacturing	NIN100 Introduction to Engineering (Non-graded)	NEW100 Professional Ethics and Social Responsibility-1 (Non-graded)	MLN100 Language and Writing Skills-1 (Non-Graded)						
	3 1 0 4	0 0 2 1	0 0 4 2	3 1 0 4	3 1 0 4	0 0 4 2	0 0 4 2	0 0 2 1	0 0 1 0.5	0 0 2 1	9 0	3	14	19.0	2.5	31.0
II	APL100 Engineering Mechanics	COL100 Introduction to Computer Science	CML101 Introduction to Chemistry	MTL101 Linear Algebra and Differential Equations	CMP100 Chemistry Laboratory			NEW101 Professional Ethics and Social Responsibility-2 (Non-graded)	NLN101 Language and Writing Skills-2 (Non-Graded)							
	3 1 0 4	3 0 2 4	3 1 0 4	3 1 0 4	0 0 4 2			0 0 1 0.5	0 0 2 1		12	3	6	18.0	1.5	24.0
Note: Courses 1-6 above are attended in the given order by half of all first year students. The other half of first year students attend the Courses 1-6 of II semester first.																
III	COL202 Discrete Mathematical Structures	COL215 Digital Logic & System Design	COL106 Data Structures & Algorithms	PYLXXX Programme-linked courses in Physics	MTL106 Probability and Stochastic Processes											
	3 1 0 4	3 0 4 5	3 0 4 5	3 0 0 3	3 1 0 4											
IV	COL226 Programming Languages	COL216 Computer Architecture	ELL205 Signals and Systems	CVL100 Environmental Science	HUL2XX HUL2XX	COP290 Design Practices					15	2	8	21.0	0	25.0
	3 0 4 5	3 0 2 4	3 1 0 4	2 0 0 2	3 1 0 4	0 0 6 3					14	2	12	22.0	0	28.0
V	COL333 / DE 1 Principles of Artificial Intelligence*	COL334 Computer Networks	COL351 Analysis and Design of Algorithms	SBL100 Introductory Biology for Engineers	HUL2XX HUL2XX											
	3 0 2 4	3 0 2 4	3 1 0 4	3 0 2 4	3 1 0 4						15	2	6	20.0	0	23.0
VI	COL362 / DE1 Introduction to Database Management Systems*	COL331 Operating Systems	COL352 Intro to Automata & Theory of Computation	MTLXXX Programme-Linked course in Mathematics	HUL2XX HUL2XX	COL380 Intro to Parallel & Distributed Programming										
	3 0 2 4	3 0 4 5	3 0 0 3	3 0 0 3	3 1 0 4	2 0 2 3					17	1	8	22.0	0	26.0
VII	DE 2 (3)	DE 3(4)	COL703 Logic for Computer Science	OC 1 (3)		PE 1 (3)										
	3 0 0 3	3 0 2 4	3 0 2 4	3 0 0 3		3 0 0 3					15	0	4	17.0	0	19.0
VIII	COD891 Minor Project	COL726 Numerical Algorithms	HUL3XX HUL3XX	PE 2 (3)	PE 3 (3)	OC (2)										
	0 0 6 3	3 0 2 4	3 0 0 3	3 0 0 3	3 0 0 3	3 0 0 3					15	0	8	19.0	0	23.0
IX	PE 4 (3)	PE 5 (3)	COD892 M.Tech Project Part I	OC (3)												
	3 0 0 3	3 0 0 3	0 0 14 7	3 0 0 3							9	0	14	16.0	0	23.0
X			COD893 M.Tech Project Part II													
			0 0 28 14								0	0	28	14.0	0	28.0
																TOTAL=188.0

Bachelor of Technology in Electrical Engineering

Department of Electrical Engineering

The overall Credit Structure

Course Category	Credits
Institute Core Courses	
Basic Sciences (BS)	24
Engineering Arts and Science (EAS)	19
Humanities and Social Sciences (HuSS)	15
Programme-linked Courses	15
Departmental Courses	
Departmental Core	60
Departmental Electives	10
Open Category Courses	10
Total Graded Credit requirement	153
Non Graded Units	11

Institute Core: Basic Sciences

CML101	Introduction to Chemistry	3	1	0	4
CMP100	Chemistry Laboratory	0	0	4	2
MTL100	Calculus	3	1	0	4
MTL101	Linear Algebra and Differential Equations	3	1	0	4
PYL101	Electromagnetism & Quantum Mechanics	3	1	0	4
PYP100	Physics Laboratory	0	0	4	2
SBL100	Introductory Biology for Engineers	3	0	2	4
Total Credits					24

Institute Core: Engineering Arts and Sciences

APL100	Engineering Mechanics	3	1	0	4
COL100	Introduction to Computer Science	3	0	2	4
CVL100	Environmental Science	2	0	0	2
ELL101	Introduction to Electrical Engineering	3	1	0	4
ELP101	Introduction to Electrical Engineering (Lab)	0	0	2	1
MCP100	Introduction to Engineering Visualization	0	0	4	2
MCP101	Introduction to Product Realization through Manufacturing	0	0	4	2
Total Credits					19

Humanities and Social Sciences

Courses from Humanities, Social Sciences and Management offered under this category					15
---	--	--	--	--	-----------

Programme-Linked Basic/Engineering Arts/Sciences Core

COL106	Data Structures and Algorithms	3	0	4	5
MTL106	Probability and Stochastic Processes	3	1	0	4
MCL142	Thermal Science for Electrical Engineers	3	0	0	3
PYL102	Principles of Electronic Materials	3	0	0	3
Total Credits					15

Departmental Core

ELL201	Digital Electronics	3	0	3	4.5
ELL202	Circuit Theory	3	1	0	4

ELL203	Electromechanics	3	1	0	4
ELP203	Electromechanics Laboratory	0	0	3	1.5
ELL205	Signals and Systems	3	1	0	4
ELL211	Physical Electronics	3	0	0	3
ELL212	Engineering Electromagnetics	3	1	0	4
ELP212	Electromagnetics Laboratory	0	0	3	1.5
ELL225	Control Engineering-I	3	1	0	4
ELP225	Control Engineering Laboratory	0	0	3	1.5
ELL302	Power Electronics	3	0	0	3
ELP302	Power Electronics Laboratory	0	0	3	1.5
ELL303	Power Engineering-I	3	1	0	4
ELP303	Power Engineering Laboratory	0	0	3	1.5
ELL304	Analog Electronic Circuits	3	1	3	5.5
ELL305	Computer Architecture	3	0	0	3
ELP305	Design and System Laboratory	0	0	3	1.5
ELL311	Communication Engineering	3	1	0	4
ELP311	Communication Engineering Laboratory	0	0	2	1
ELD411	B.Tech. Project-I	0	0	6	3

Total Credits **60**

Departmental Electives

ELL301	Electrical and Electronics Instrumentation	3	0	0	3
ELL312	Semiconductor process technology	3	0	0	3
ELL313	Antennas and Propagation	3	0	0	3
ELL315	Introduction to Analog Integrated Circuits	3	0	0	3
ELL316	Introduction to VLSI Design	3	0	0	3
ELL318	Digital Hardware Design	3	0	0	3
ELL319	Digital Signal Processing	3	0	2	4
ELL332	Electric Drives	3	0	0	3
ELL333	Multivariable Control	3	0	0	3
ELL365	Embedded Systems	3	0	0	3
ELL400	Power Systems Protection	3	0	0	3
ELL401	Advanced Electromechanics	3	0	0	3
ELL402	Computer Communication	3	0	0	3
ELL405	Operating Systems	3	0	0	3
ELL406	Robotics and Automation	3	0	0	3
ELL407	Power Quality	3	0	2	4
ELL409	Machine Intelligence and Learning	3	0	2	4
ELL410	Multicore Systems	3	0	0	3
ELL411	Digital Communications	3	0	2	4
ELL703	Optimal Control Theory	3	0	0	3
ELL710	Coding Theory	3	0	0	3
ELL715	Digital Image Processing	3	0	2	4
ELL716	Telecommunication Switching and Transmission	3	0	0	3
ELL725	Wireless Communications	3	0	0	3
ELL730	I.C. Technology	3	0	0	3
ELL738	Micro and Nano Photonics	3	0	0	3
ELL740	Compact Modeling of Semiconductor Devices	3	0	2	4
ELL758	Power Quality	3	0	0	3
ELL765	Smart Grid Technology	3	0	0	3
ELS310	Independent Study (EL)	0	3	0	3

Semester	Course-1	Course-2	Course-3	Course-4	Course-5	Course-6	Course-7	Course-8	Course-9	Course-10	L	T	P	Credits	Non-Graded Units	Contact Hours
I	ELL101	ELP101	MCP100	PYL101	MTL100	PYP100	MCP101	NIN100	NEW100	NLN100						
	Introduction to Electrical Engineering	Introduction to Electrical Engineering (Lab.)	Introduction to Engineering Visualization	Electromagnetism & Quantum Mechanics	Calculus	Physics Laboratory	Product Realization through Manufacturing	Introduction to Engineering (Non-graded)	Professional Ethics and Social Responsibility-1 (Non-graded)	Language and Writing Skills-1 (Non-Graded)	9.0	3	14	19.0	2.5	31.0
	3 1 0 4	0 0 2 1	0 0 4 2	3 1 0 4	3 1 0 4	0 0 4 2	0 0 4 2	0 0 2 1	0 0 1 0.5	0 0 2 1						
II	APL100	COL100	CML101	MTL101	CMP100			NEW101	NLN101							
	Engineering Mechanics	Introduction to Computer Science	Introduction to Chemistry	Linear Algebra and Differential Equations	Chemistry Laboratory			Professional Ethics and Social Responsibility-2 (Non-graded)	Language and Writing Skills-2 (Non-Graded)							
	3 1 0 4	3 0 2 4	3 1 0 4	3 1 0 4	0 0 4 2			0 0 1 0.5	0 0 2 1		12	3	6	18.0	1.5	24.0
Note: Courses 1-6 above are attended in the given order by half of all first year students. The other half of First year students attend the Courses 1-6 of II semester first.																
III	ELL202	COL106	ELL203	ELL211	ELL205	HUL 2XX										
	Circuit Theory	Data Structures & Algorithms	Electromechanics	Physical Electronics	Signals and Systems											
	3 1 0 4	3 0 4 5	3 1 0 4	3 0 0 3	3 1 0 4	3 1 0 4					18.0	4	4	24.0	0	26.0
IV	ELL201	ELL212	SBL100	MTL106	ELL225	ELP203										
	Digital Electronics	Engineering Electromagnetics	Introductory Biology for Engineers	Probability and Stochastic Processes	Control Engineering-I	Electromechanics Laboratory										
	3 0 3 4.5	3 1 0 4	3 0 2 4	3 1 0 4	3 1 0 4	0 0 3 1.5					15.0	3	8	22.0	0	26.0
V	ELL304	ELL311	CVL100	ELL302	ELL305	ELP212	ELP225									
	Analog Electronic Circuits	Communication Engineering	Environmental Science	Power Electronics	Computer Architecture	Electromagnetics Laboratory	Control Engineering Lab									
	3 1 3 5.5	3 1 0 4	2 0 0 2	3 0 0 3	3 0 0 3	0 0 3 1.5	0 0 3 1.5				14.0	2	9	20.5	0	25.0
VI	MCL142	HUL2XX	PYL102	ELL303	DE 1	ELP311	ELP305	ELP302								
	Thermal Science for Electrical Engineers		Principles of Electronic Materials	Power Engineering-I	Communication Engineering Laboratory	Design and System Laboratory	Power Electronics Laboratory									
	3 0 0 3	3 1 0 4	3 0 0 3	3 1 0 4	0 0 2 4	0 0 2 1	0 0 3 1.5	0 0 3 1.5			15.0	2	10	22.0	0	27.0
VII		HUL2XX	DE 2	OC1	ELD411	ELP303										
					B.Tech. Project	Power Engineering Laboratory										
		3 1 0 4	3 0 0 3	3 0 2 4	0 0 6 3	0 0 3 1.5					9.0	1	11	15.5	0	21.0
VIII	DE 3	OC2	OC3	HUL3XX												
	3 0 0 3	3 0 0 3	3 0 0 3	3 0 0 3							12.0	0	0	12.0	0	12.0
TOTAL=153.0																

Bachelor of Technology in Electrical Engineering Power and Automation

Department of Electrical Engineering

The overall Credit Structure

Course Category	Credits
Institute Core Courses	
Basic Sciences (BS)	24
Engineering Arts and Science (EAS)	19
Humanities and Social Sciences (HuSS)	15
Programme-linked Courses	15
Departmental Courses	
Departmental Core	60
Departmental Electives	10
Open Category Courses	10
Total Graded Credit requirement	153
Non Graded Units	11

Institute Core : Basic Sciences

CML101	Introduction to Chemistry	3	1	0	4
CMP100	Chemistry Laboratory	0	0	4	2
MTL100	Calculus	3	1	0	4
MTL101	Linear Algebra and Differential Equations	3	1	0	4
PYL101	Electromagnetism & Quantum Mechanics	3	1	0	4
PYP100	Physics Laboratory	0	0	4	2
SBL100	Introductory Biology for Engineers	3	0	2	4
Total Credits					24

Institute Core: Engineering Arts and Sciences

APL100	Engineering Mechanics	3	1	0	4
COL100	Introduction to Computer Science	3	0	2	4
CVL100	Environmental Science	2	0	0	2
ELL101	Introduction to Electrical Engineering	3	1	0	4
ELP101	Introduction to Electrical Engineering (Lab)	0	0	2	1
MCP100	Introduction to Engineering Visualization	0	0	4	2
MCP101	Product Realization through Manufacturing	0	0	4	2
Total Credits					19

Humanities and Social Sciences

Courses from Humanities, Social Sciences and Management offered under this category **15**

Programme-Linked Basic/Engineering Arts/Sciences Core

COL106	Data Structures and Algorithms	3	0	4	5
MTL106	Probability and Stochastic Processes	3	1	0	4
MCL142	Thermal Science for Electrical Engineers	3	0	0	3
PYL102	Principles of Electronic Materials	3	0	0	3
Total Credits					15

Departmental Core

ELL201	Digital Electronics	3	0	3	4.5
--------	---------------------	---	---	---	-----

ELL202	Circuit Theory	3	1	0	4
ELL203	Electromechanics	3	1	0	4
ELP203	Electromechanics Laboratory	0	0	3	1.5
ELL205	Signals and Systems	3	1	0	4
ELL225	Control Engineering-I	3	1	0	4
ELP225	Control Engineering Laboratory	0	0	3	1.5
ELL231	Power Electronics and Energy Devices	3	0	0	3
ELL302	Power Electronics	3	0	0	3
ELP302	Power Electronics Laboratory	0	0	3	1.5
ELL303	Power Engineering-I	3	1	0	4
ELP303	Power Engineering Laboratory	0	0	3	1.5
ELL304	Analog Electronic Circuits	3	1	3	5.5
ELL305	Computer Architecture	3	0	0	3
ELP305	Design and System Laboratory	0	0	3	1.5
ELL332	Electric Drives	3	0	0	3
ELP332	Electric Drives Laboratory	0	0	3	1.5
ELL363	Power Engineering-II	3	0	0	3
ELL365	Embedded Systems	3	0	0	3
ELD431	B.Tech. Project-I	0	0	6	3
Total Credits					60

Departmental Electives

ELL301	Electrical and Electronics Instrumentation	3	0	0	3
ELL311	Communication Engineering	3	1	0	4
ELL319	Digital Signal Processing	3	0	2	4
ELL333	Multivariable Control	3	0	0	3
ELL334	Multivariable Control	3	0	2	4
ELL400	Power Systems Protection	3	0	0	3
ELL401	Advanced Electromechanics	3	0	0	3
ELL405	Operating Systems	3	0	0	3
ELL406	Robotics and Automation	3	0	0	3
ELL407	Power Quality	3	0	2	4
ELL409	Machine Intelligence and Learning	3	0	2	4
ELL410	Multicore Systems	3	0	0	3
ELL417	Renewable Energy System	3	0	0	3
ELL431	Power System Optimization	3	0	0	3
ELL436	Digital Control	3	0	0	3
ELL437	Switch Mode Power Conversion	3	0	0	3
ELL453	Power System Dynamics and Control	3	0	0	3
ELL703	Optimal Control Theory	3	0	0	3
ELL715	Digital Image Processing	3	0	2	4
ELL730	I.C. Technology	3	0	0	3
ELL758	Power Quality	3	0	0	3
ELL765	Smart Grid Technology	3	0	0	3
ELS330	Independent Study (EP)	0	3	0	3

Semester	Course-1	Course-2	Course-3	Course-4	Course-5	Course-6	Course-7	Course-8	Course-9	Course-10	L	T	P	Credits	Non-Graded Units	Contact Hours	
I	ELL101 Introduction to Electrical Engineering	ELP101 Introduction to Electrical Engineering (Lab.)	MCP100 Introduction to Engineering Visualization	PYL101 Electromagnetism & Quantum Mechanics	MTL100 Calculus	PYP100 Physics Laboratory	MCP101 Product Realization through Manufacturing	NIN100 Introduction to Engineering (Non-graded)	NEN100 Professional Ethics and Social Responsibility-1 (Non-graded)	NLN100 Language and Writing Skills-1 (Non-Graded)	9.0	3	14	19.0	2.5	31.0	
	APL100 Engineering Mechanics	COL100 Introduction to Computer Science	CML101 Introduction to Chemistry	MTL101 Linear Algebra and Differential Equations	CMP100 Chemistry Laboratory			NEN101 Professional Ethics and Social Responsibility-2 (Non-graded)	NLN101 Language and Writing Skills-2 (Non-Graded)								
	3 1 0 4	3 0 0 2 1	0 0 4 2	3 1 0 4	3 1 0 4	0 0 4 2	0 0 4 2	0 0 4 2	0 0 1 0.5	0 0 2 1	0 0 2 1	9.0	3	14	19.0	2.5	31.0
II	3 1 0 4	3 0 2 4	3 1 0 4	3 1 0 4	0 0 4 2			0 0 1 0.5	0 0 2 1		12	3	6	18.0	1.5	24.0	
	ELL202 Circuit Theory	COL106 Data Structures & Algorithms	ELL203 Electromechanics	SBL100 Introductory Biology for Engineers	ELL205 Signals and Systems												
	3 1 0 4	3 0 4 5	3 1 0 4	3 0 2 4	3 1 0 4												
III	ELL201 Digital Electronics	ELL231 Power Electronics and Energy Devices	CVL100 Environmental Science	MTL106 Probability and Stochastic Processes	ELL225 Control Engineering-I	ELP203 Electromechanics Laboratory	HUL2XX				15	3	6	21.0	0	24.0	
	3 0 3 4.5	3 0 0 3	2 0 0 2	3 1 0 4	3 1 0 4	0 0 3 1.5	3 1 0 4				17	3	6	23.0	0	26.0	
	ELL304 Analog Electronic Circuits	DE 1	ELL302 Power Electronics	HUL2XX	ELL305 Computer Architecture	ELP225 Control Engineering-I											
IV	3 1 3 5.5	3 0 2 4	3 0 0 3	3 1 0 4	3 0 0 3	0 0 3 1.5					15	2	8	21.0	0	25.0	
	MCL142 Thermal Science for Electrical Engineers	ELL365 Embedded Systems	PYL102 Principles of Electronic Materials	ELL303 Power Engineering-I	ELL332 Electric Drives	ELP305 Design and System Laboratory	ELP302 Power Electronics Laboratory										
	3 0 0 3	3 0 0 3	3 0 0 3	3 1 0 4	3 0 0 3	0 0 3 1.5	0 0 3 1.5				15	1	6	19.0	0	22.0	
V		HUL2XX	ELL363	OC1	ELD431 B.Tech. Project I	ELP303 Power Engineering Laboratory	ELP332 Electric Drives Laboratory										
	DE 2	DE 3	OC2	OC3	HUL3XX						9	1	14	17.0	0	24.0	
	3 0 0 3	3 1 0 4	3 0 0 3	3 0 2 4	0 0 6 3	0 0 3 1.5	0 0 3 1.5										
VI																	
	DE 2	DE 3	OC2	OC3	HUL3XX												
	3 0 0 3	3 0 0 3	3 0 0 3	3 0 0 3	3 0 0 3						15	0	0	15.0	0	15.0	
VII																	
	DE 2	DE 3	OC2	OC3	HUL3XX												
	3 0 0 3	3 0 0 3	3 0 0 3	3 0 0 3	3 0 0 3												
VIII																	
	DE 2	DE 3	OC2	OC3	HUL3XX												
	3 0 0 3	3 0 0 3	3 0 0 3	3 0 0 3	3 0 0 3												
TOTAL=153.0																	

Note: Courses 1-6 above are attended in the given order by half of all first year students. The other half of First year students attend the Courses 1-6 of II semester first.

Bachelor of Technology in Energy Engineering

Department of Energy Science and Engineering

The overall Credit Structure

Course Category	Credits
Institute Core Courses	
Basic Sciences (BS)	24
Engineering Arts and Science (EAS)	19
Humanities and Social Sciences (HuSS)	15
Programme-linked Courses	12
Departmental Courses	
Departmental Core	67
Departmental Electives	10
Open Category Courses	10
Total Graded Credit requirement	157
Non Graded Units	11

Institute Core : Basic Sciences

CML101	Introduction to Chemistry	3	1	0	4
CMP100	Chemistry Laboratory	0	0	4	2
MTL100	Calculus	3	1	0	4
MTL101	Linear Algebra and Differential Equations	3	1	0	4
PYL101	Electromagnetism & Quantum Mechanics	3	1	0	4
PYP100	Physics Laboratory	0	0	4	2
SBL100	Introductory Biology for Engineers	3	0	2	4
Total Credits					24

Institute Core: Engineering Arts and Sciences

APL100	Engineering Mechanics	3	1	0	4
COL100	Introduction to Computer Science	3	0	2	4
CVL100	Environmental Science	2	0	0	2
ELL101	Introduction to Electrical Engineering	3	1	0	4
ELP101	Introduction to Electrical Engineering (Lab)	0	0	2	1
MCP100	Introduction to Engineering Visualization	0	0	4	2
MCP101	Product Realization through Manufacturing	0	0	4	2
Total Credits					19

Programme-Linked Basic/Engineering Arts/Sciences Core

MCL140	Engineering Thermodynamics	3	1	0	4
MCL242	Heat Transfer	3	1	0	4
MLL100	Introduction to Materials Science and Engg.*	3	0	2	4
Total Credits					12

* APL102 is superseded by MLL100

Humanities and Social Sciences

Courses from Humanities, Social Sciences and Management offered under this category					15
---	--	--	--	--	-----------

Departmental Core

APL105	Mechanics of Solids and Fluids	3	1	0	4
ESL100	Energy Resources and Utilization	3	1	0	4
ESL260	Network Analysis	2	1	0	3
ESL220	Semiconductors for Energy Systems	3	0	0	3
ESL261	Analog and Digital Electronics	3	0	0	3
ESL200	Fundamentals of Energy Engineering	3	1	2	5
ESL262	Electrical Machines	3	0	0	3
ESL280	Introduction to Plasma Concepts	3	0	2	4
ESL263	Power Electronics and Drives for Energy Engg.	3	0	0	3
ESL370	Control Systems and Automation	3	0	0	3
ESL341	Energy Storage	3	0	0	3
ESL371	Design of Energy Systems	3	1	0	4

ESL361	Power Systems and Smart Grid Operations	3	0	0	3
ESL373	Computational Methods for Energy Systems	3	0	2	4
ESL352	Hydrogen Economy	3	0	0	3
ESP260	Electrical Energy Laboratory	0	0	3	1.5
ESP300	Energy Innovation Laboratory	0	0	3	1.5
ESL372	Intelligent Techniques for Energy System Analysis	3	0	0	3
ESL390	Energy Economics	3	0	0	3
ESD400	B. Tech Project – I	0	0	6	3
ESL400	Energy Efficiency	3	0	0	3

Total Credits **67**

Departmental Electives

ESL300	Self-organizing Dynamical Systems	3	0	0	3
ESL320	Building Integrated Photovoltaics	3	0	0	3
ESL330	Energy, Ecology and Environment	3	1	0	4
ESL331	Hydrodynamic Machines	3	1	0	4
ESL342	Nanotechnology in Energy Conversion and Storage	3	0	0	3
ESL351	Fundamentals of Internal Combustion Engines	3	0	0	3
ESL360	Direct Energy Conversion Methods	3	1	0	4
ESL374	Smart Devices for Energy Harvesting	3	0	0	3
ESL375	IoT for Energy Systems	3	0	0	3
ESL376	Smart Buildings	3	0	0	3
ESL377	Optimization of Energy System	3	0	0	3
ESL380	Basics of Nuclear Fission and Fusion	3	1	0	4
ESL381	Plasma Science	3	1	0	4
ESL382	Plasma Sources and Diagnostics	3	0	0	3
ESL410	Waste to Energy	3	0	0	3
ESL420	Industry Relevant Photovoltaic Technologies	3	0	0	3
ESL450	Hybrid Vehicles	3	0	0	3
ESL480	Plasma Chemistry	3	0	0	3
ESL481	Plasma Based Technologies for Smart Materials	3	0	0	3
ESL490	Wind and Tidal Wave Energy	3	0	0	3
ESL732	Bioconversion and Processing of Waste	3	0	0	3
ESL738	Power System Planning and Operation	3	0	0	3
ESL739	Bioenergy: Resources, Technologies and Applications	3	0	0	3
ESL742	Economics and Financing of Renewable Energy Systems	3	0	0	3
ESL746	Hydrogen Energy	3	0	0	3
ESL749	Developing Energy Efficiency and Renewable Energy Projects	2	0	2	3
ESL750	Economics and Planning of Energy Systems	3	0	0	3
ESL753	Solar Thermal Technologies and Applications	3	0	0	3
ESL755	Solar Photovoltaic Devices and Systems	3	0	0	3
ESL756	Energy Policy and Planning	3	0	0	3
ESL762	Computational Fluid Dynamics for Energy Systems	3	0	2	4
ESL768	Wind and Small Hydro Energy Systems	3	0	0	3
ESL769	Design of Wind Turbines	2	0	2	3
ESL774	Quantitative Methods and Planning for Energy Systems	3	0	0	3
ESL776	Industrial Energy and Environment Analysis	3	0	0	3
ESL784	Cogeneration and Energy Efficiency	3	0	0	3
ESL791	Renewable Energy Integration and Power Systems	3	0	0	3
ESL796	Operation and Control of Electrical Energy Systems	3	0	0	3
ESL798	Distributed and Decentralized Energy Systems	3	0	0	3
ESL845	Net Zero Energy Buildings	3	0	0	3
ESL855	Solar Photovoltaic Power Generation	3	0	0	3
ESD406	B.Tech. Project-II	0	0	18	9

Semester	Course-1	Course-2	Course-3	Course-4	Course-5	Course-6	Course-7	Course-8	Course-9	Course-10	L	T	P	Credits	Non-Graded Units	Contact Hours
I	ELL101 Introduction to Electrical Engineering	ELP101 Introduction to Electrical Engineering (Lab.)	MCP100 Introduction to Engineering Visualization	PYL101 Electromagnetism & Quantum Mechanics	MTL100 Calculus	PYP100 Physics Laboratory	MCP101 Product Realization through Manufacturing	NIN100 Introduction to Engineering (Non-graded)	NEN100 Professional Ethics and Social Responsibility-1 (Non-graded)	NLN100 Language and Writing Skills-1 (Non-Graded)						
	3 1 0 4	0 0 2 1	0 0 4 2	3 1 0 4	3 1 0 4	0 0 4 2	0 0 4 2	0 0 2 1	0 0 1 0.5	0 0 2 1	9.0	3	14	19.0	2.5	31.0
II	APL100 Engineering Mechanics	COL100 Introduction to Computer Science	CML101 Introduction to Chemistry	MTL101 Linear Algebra and Differential Equations	CMP100 Chemistry Laboratory			NEN101 Professional Ethics and Social Responsibility-2 (Non-Graded)	NLN101 Language and Writing Skills-2 (Non-Graded)							
	3 1 0 4	3 0 2 4	3 1 0 4	3 1 0 4	0 0 4 2			0 0 1 0.5	0 0 2 1		12	3	6	18.0	1.5	24.0
Note: Courses 1-6 above are attended in the given order by half of all first year students. The other half of First year students attend the Courses 1-6 of II semester first.																
III	MCL140 Engineering Thermodynamics	MCL242 Heat Transfer	ESL100 Energy Resource and Utilization	ESL260 Network Analysis	ESL220 Semiconductors for Energy Systems	ESL261 Analog and Digital Electronics										
	3 1 0 4	3 1 0 4	3 1 0 4	2 1 0 3	3 0 0 3	3 0 0 3					17	4	0	21.0	0	21.0
	MLL100 Introduction to Materials Science and Engineering	APL105 Mechanics of Solids and Fluids	ESL200 Fundamentals of Energy Engineering	CVL100 Environmental Science	SBL100 Introductory Biology for Engineers	ELP203 Electromechanics Laboratory		HUL2XX								
IV	ESL262 Electrical Machines	ESL280 Introduction to Plasma Concepts	ESL263 Power Electronics and Drives for Energy Engg.	ESL370 Control System and Automation	ESL371 Design of Energy Systems			HUL2XX								
	3 0 2 4	3 1 0 4	3 1 2 5	2 0 0 2	3 0 2 4	0 0 3 1.5	3 1 0 4				17	3	6	23.0	0	26.0
	ESL341 Energy Storage	ESL361 Power Systems and Smart Grid Operations	ESL373 Computational Methods for Energy Systems	ESL352 Hydrogen Economy			HUL2XX	ESP260 Electrical Energy Laboratory	ESP300 Energy Innovation Laboratory			18	2	2	21.0	0
VI	ESL372 Intelligent Techniques for Energy System Analysis	ESL390 Energy Economics	ESL400 Energy Efficiency		DE-1	HUL2XX			ESD400							
	3 0 0 3	3 0 0 3	3 0 0 3	3 0 0 3			3 1 0 4	0 0 3 1.5	0 0 3 1.5		15	1	8	20.0	0	24.0
									B. Tech Project - I							
VII					DE-2				0 0 6 3		15	0	6	18.0	0	21.0
VIII		OC2		OC3	DE-3						15	2	0	0	0	17.0
	3 0 0 3	3 0 0 3	3 0 0 4	3 1/0 0/2 4	0 0 0 7	14	7	0 0 0 14	0 0 0 7		9	1	14	17.0	0	24
TOTAL=157.0																

Bachelor of Technology in Materials Engineering

Department of Materials Science and Engineering

The overall Credit Structure

Course Category	Credits
Institute Core Courses	
Basic Sciences (BS)	24
Engineering Arts and Science (EAS)	19
Humanities and Social Sciences (HuSS)	15
Programme-linked Courses	11
Departmental Courses	
Departmental Core	64
Departmental Electives	12
Open Category Courses	10
Total Graded Credit requirement	155
Non Graded Units	11

MLL371	Materials Processing	2	0	2	3
MLL213	Materials Modelling	1	0	4	3
MLL262	Principles of metal extraction	3	1	0	4
MLL452	Corrosion and Degradation of Materials	3	0	2	4
MLL372	Materials Selection and Design	3	0	0	3
MLL264	Glass and Ceramics	2	0	0	2
MLS302	Research Practice for Beginners	0	0	2	1
MLP352	Mechanical Behavior of Materials Lab	0	0	3	1.5
MLP354	Functional Materials Lab	0	0	3	1.5
MLP473	Materials Selection and Design Lab	0	0	3	1.5
MLL181	Materials and Sustainable Development	3	0	0	3
MLD411	B.Tech Project-BTP-I	0	0	8	4
Total Credits					64

Institute Core : Basic Sciences

CML101	Introduction to Chemistry	3	1	0	4
CMP100	Chemistry Laboratory	0	0	4	2
MTL100	Calculus	3	1	0	4
MTL101	Linear Algebra and Differential Equations	3	1	0	4
PYL101	Electromagnetism & Quantum Mechanics	3	1	0	4
PYP100	Physics Laboratory	0	0	4	2
SBL100	Introductory Biology for Engineers	3	0	2	4
Total Credits					24

Institute Core: Engineering Arts and Sciences

APL100	Engineering Mechanics	3	1	0	4
COL100	Introduction to Computer Science	3	0	2	4
CVL100	Environmental Science	2	0	0	2
ELL101	Introduction to Electrical Engineering	3	1	0	4
ELP101	Introduction to Electrical Engineering (Lab.)	0	0	2	1
MCP100	Introduction to Engineering Visualization	0	0	4	2
MCP101	Product Realization through Manufacturing	0	0	4	2
Total Credits					19

Programme-Linked Basic/Engineering Arts/Sciences Core

MTL107	Numerical Methods and Computations	3	0	0	3
APL104	Solid Mechanics	3	1	0	4
CLL110	Transport Phenomena	3	1	0	4
Total Credits					11

Humanities and Social Sciences

Courses from Humanities, Social Sciences and Management offered under this category	15
---	-----------

Departmental Core

MLL100	Introduction to Materials Science & Engg.*	3	0	2	4
MLL103	Intro to Thermodynamics of Materials	3	1	0	4
MLL102	Structure of Materials	2	1	0	3
MLL104	Characterization of Materials I	3	0	3	4.5
MLL202	Phase Equilibria and Transformations	2	1	0	3
MLL212	Math. Methods in Materials Engineering	2	1	0	3
MLL242	Introduction to Polymeric Materials	3	0	2	4
MLL251	Mechanical Behavior of Materials	3	1	0	4
MLL253	Electronic, Optical and Magnetic Properties of Materials	3	0	0	3

* APL102 is superseded by MLL100

Departmental Electives

MLS300	Independent study	3	0	0	3
MLL351	Iron and Steel Making	2	0	0	2
MLL353	Metal Casting Technology	2	0	2	3
MLP362	Metallography Lab	0	0	4	2
MLD412	B.Tech. Project (Part -2)	0	0	12	6
MLD413	Major project in Polymeric Materials	0	0	12	6
MLD414	Major project in Metallurgy	0	0	12	6
MLL203	Characterization of Materials-II	3	0	0	3
MLL341	Engineering Biomaterials	2	0	0	2
MLL342	Physical Chemistry of Polymers	3	0	0	3
MLL343	Polymer and Elastomer Technology	3	0	0	3
MLL344	Rheology and processing of polymers	3	0	2	4
MLL345	Polymer Matrix composites	2	0	0	2
MLL364	Welding Metallurgy	2	0	2	3
MLL365	Powder Metallurgy	3	0	0	3
MLL366	Heat Treatment and Surface Engineering	2	0	2	3
MLL730	Diffusion & Kinetics	3	0	0	3
PTL712	Polymer Blends and Composites Materials	3	0	0	3
PTL718	Polymer Reaction Engineering	3	0	0	3
PTL720	Polymer Product and Mould Design	2	0	2	3
PTL714	Biodegradable Polymeric Materials	3	0	0	3
MLL714	Fracture Mechanics	3	0	0	3
MLL715	Advanced Engineering Materials	3	0	0	3
MLL716	Engineering Failure Analysis & Prevention	3	0	0	3
MLL717	Engineering Plastics and Specialty Polymers	3	0	0	3
PHL704	Science and Technology of thin films	3	0	0	3
CML723	Principles and practices of NMR and optical spectroscopy	3	0	0	3
APL736	Multiscale Modelling of Crystalline Materials	3	0	2	4
CML734	Chemistry of Nanostructured Materials	3	0	0	3
ELL212	Electromagnetics	3	1	0	4
MLL732	Porous Materials	3	0	0	3
MLL734	Texture and Grain Boundary Engineering in metals and alloys	3	0	0	3
MLL736	Tribology and Surface Engg. of Materials	3	0	0	3
MLL738	Electronic Devices and Characterization	3	0	0	3
MLL740	Nanostructures and Nanomaterials	3	0	0	3
MLL742	Micro and nanofabrication in Materials Engg.	3	0	0	3
MLL744	Materials for Additive Manufacturing	3	0	0	3
MLL746	Crystals, Symmetry, and Tensors	3	2	0	5

Semester	Course-1		Course-2		Course-3		Course-4		Course-5		Course-6		Course-7		Course-8		Course-9		Course-10		L	T	P	Credits	Non-Graded Units	Contact Hours		
	ELL101	Introduction to Electrical Engineering	ELP101	Introduction to Electrical Engineering (Lab.)	MCP100	Introduction to Engineering Visualization	PYL101	Electromagnetism & Quantum Mechanics	MTL100	Calculus	PYP100	Physics Laboratory	MCP101	Product Realization through Manufacturing	MIN100	Introduction to Engineering (Non-graded)	NEN100	Professional Ethics and Social Responsibility-1 (Non-graded)	NEN100	Professional Ethics and Social Responsibility-1 (Non-graded)							Language and Writing Skills-1 (Non-Graded)	
I	3	1 0 4	0 0 2 1	0 0 4 2	3 1 0 4	3 1 0 4	3 1 0 4	3 1 0 4	3 1 0 4	3 1 0 4	0 0 4 2	0 0 4 2	0 0 4 2	0 0 4 2	0 0 2 1	0 0 1 0.5	0 0 1 0.5	0 0 2 1	0 0 2 1	0 0 2 1	9.0	3	14	19.0	2.5	31.0		
	APL100	Engineering Mechanics	COL100	Introduction to Computer Science	CML101	Introduction to Chemistry	MTL101	Linear Algebra and Differential Equations	CMPT100	Chemistry Laboratory					NEN101	Professional Ethics and Social Responsibility-2 (Non-graded)	NEN101	Language and Writing Skills-2 (Non-Graded)										
II	3	1 0 4	3 0 2 4	3 1 0 4	3 1 0 4	3 1 0 4	3 1 0 4	3 1 0 4	3 1 0 4	0 0 4 2					0 0 1 0.5	0 0 2 1				12	3	6	18.0	1.5	24.0			
<p>Note: Courses 1-6 above are attended in the given order by half of all first year students. The other half of first year students attend the Courses 1-6 of II semester first.</p>																												
III	APL104	Solid Mechanics	SBL100	Intro to Biology for Engineers	MLL100	Intro to Materials Science & Engineering	MLL103	Intro to Thermodynamics of Materials		HUL2XX (I)																		
	3	1 0 4	3 0 2 4	3 0 2 4	3 0 2 4	3 1 0 4	3 1 0 4	3 1 0 4		3 1 0 4											15	3	4	20.0	0	22.0		
IV	MLL102	Structure of Materials	MLL104	Characterization of Materials I	MLL202	Phase Equilibria and Transformations	MLL212	Mathematical Methods in Mat. Engg.	MLL242	Introduction to Polymeric Materials-I	MTL107	Numerical Methods and Computation																
	2	1 0 3	3 0 3 4.5	2 1 0 3	2 1 0 3	2 1 0 3	2 1 0 3	2 1 0 3	3 0 2 4	3 0 0 3	3 0 0 3	3 0 0 3	3 0 0 3	3 0 0 3	3 0 0 3	3 0 0 3	3 0 0 3	3 0 0 3	3 0 0 3	15	3	5	20.5	0	23.0			
V	CLL110	Transport Phenomena	MLL251	Mechanical Behavior of Materials	MLL253	Electronic, Optical & Magnetic Props. of Mat.	MLL371	Materials Processing	MLL213	Materials Modelling	CVL100	Environmental Science	DE I	Departmental Elective I														
	3	1 0 4	3 1 0 4	3 0 0 3	3 0 0 3	2 0 2 3	2 0 2 3	2 0 2 3	1 0 4 3	1 0 4 3	2 0 0 2	2 0 0 2	3 0 0 3	3 0 0 3							17	2	6	22.0	0	25.0		
VI	MLL262	Principles of Metal Extraction	MLL452	Corrosion and Degradation of Materials	MLL372	Materials Selection and Design	MLL264	Glass and Ceramics	MLL302	Research Practice for Beginners	MLP352	Mechanical Behavior of Materials Lab	MLP 354	Functional Materials Lab	HUL2XX (II)													
	3	1 0 4	3 0 2 4	3 0 0 3	3 0 0 3	2 0 0 2	2 0 0 2	2 0 0 2	0 0 2 1	0 0 3 1.5	0 0 3 1.5	0 0 3 1.5	0 0 3 1.5	0 0 3 1.5	3 1 0 4	3 1 0 4	3 1 0 4	3 1 0 4	3 1 0 4	3 1 0 4	14	2	10	21.0	0	26.0		
VII	MLP473	Materials Selection and Design Lab	MLL181	Materials and Sustainable Development	MLD411	Bi.Tech Project - I	DE 2		DE 3	OC1																		
	0	0 3 1.5	3 0 0 3	0 0 8 4	3 0 0 3	3 0 0 3	3 0 0 3	3 0 0 3	3 0 0 3	3 0 0 3	3 0 0 3	3 0 0 3	3 1 0 4	3 1 0 4							15	1	11	21.5	0	27.0		
VIII	DE 4		OC2		OC3		HUL3XX																					
	3	0 0 3	3 0 0 3	3 1 0 4	3 0 0 3	3 0 0 3	3 0 0 3	3 0 0 3													12	1	0	13.0	0	13.0		
																									TOTAL=155.0			

Bachelor of Technology in Mechanical Engineering

Department of Mechanical Engineering

The overall Credit Structure

Course Category	Credits
Institute Core Courses	
Basic Sciences (BS)	24
Engineering Arts and Science (EAS)	19
Humanities and Social Sciences (HuSS)	15
Programme-linked Courses	11
Departmental Courses	
Departmental Core	64
Departmental Electives	12
Open Category Courses	10
Total Graded Credit requirement	155
Non Graded Units	11

Institute Core : Basic Sciences

CML101	Introduction to Chemistry	3	1	0	4
CMP100	Chemistry Laboratory	0	0	4	2
MTL100	Calculus	3	1	0	4
MTL101	Linear Algebra and Differential Equations	3	1	0	4
PYL101	Electromagnetism & Quantum Mechanics	3	1	0	4
PYP100	Physics Laboratory	0	0	4	2
SBL100	Introductory Biology for Engineers	3	0	2	4
Total Credits					24

Institute Core: Engineering Arts and Sciences

APL100	Engineering Mechanics	3	1	0	4
COL100	Introduction to Computer Science	3	0	2	4
CVL100	Environmental Science	2	0	0	2
ELL101	Introduction to Electrical Engineering	3	1	0	4
ELP101	Introduction to Electrical Engineering (Lab.)	0	0	2	1
MCP100	Introduction to Engineering Visualization	0	0	4	2
MCP101	Product Realization through Manufacturing	0	0	4	2
Total Credits					19

Programme-Linked Basic/Engineering Arts/Sciences Core

MLL100	Introduction to Materials Science and Engineering*	3	0	2	4
MTL107	Numerical Methods and Computations	3	0	0	3
MTL108	Introduction to Statistics	3	1	0	4
Total Credits					11

* APL102 is superseded by MLL100

Humanities and Social Sciences

Courses from Humanities, Social Sciences and Management offered under this category	15
---	-----------

Departmental Core

APL 104	Solid Mechanics	3	1	0	4
APL 106	Fluid Mechanics	3	1	0	4
MCL111	Kinematics and Dynamics of Machines	3	0	2	4
MCL131	Manufacturing Processes-I	3	0	0	3
MCL140	Engineering Thermodynamics	3	1	0	4
MCL201	Mechanical Engineering Drawing	2	0	3	3.5
MCL211	Design of Machines	3	0	2	4
MCL212	Control Theory and Applications	3	0	2	4
MCL231	Manufacturing Processes-II	3	0	0	3
MCP231	Manufacturing Laboratory-I	0	0	2	1
MCL241	Energy Systems and Technologies	3	0.5	1	4
MCL242	Heat and Mass Transfer	3	1	0	4
MCL261	Introduction to Operations Research	3	0	0	3
MCP301	Mechanical Engineering Laboratory-I	0	0	3	1.5

MCL311	CAD and Finite Element Analysis	3	0	2	4
MCP331	Manufacturing Laboratory-II	0	0	2	1
MCL361	Manufacturing System Design	3	0	0	3
MCP401	Mechanical Engineering Laboratory-II	0	0	4	2
MCD411	B.Tech.Project	0	0	8	4
MCL431	CAM and Automation	2	0	2	3
Total Credits					64

Departmental Electives

MCD310	Mini Project	0	0	6	3
MCL314	Acoustics and Noise Control	3	0	2	4
MCL321	Automotive Systems	3	0	2	4
MCL322	Power Train Design	3	0	0	3
MCL330	Special Topics Production Engineering	3	0	0	3
MCL334	Industrial Automation	3	0	2	4
MCL336	Advances in Welding	3	0	2	4
MCL337	Advanced Machining Processes	3	0	0	3
MCL338	Mechatronic Applications in Manufacturing	3	0	2	4
MCL341	Gas Dynamics and Propulsion	3	0	2	4
MCL343	Introduction to Combustion	3	0	0	3
MCL344	Refrigeration and Air-conditioning	3	0	2	4
MCL345	Reciprocating Internal Combustion Engines	3	0	2	4
MCL347	Intermediate Heat Transfer	3	0	0	3
MCL348	Thermal Management of Electronics	3	0	0	3
MCL350	Mechanical Engineering Product Synthesis	1	0	2	2
MCL363	Investment Planning	3	0	0	3
MCL364	Value Engineering	3	0	2	4
MCL366	OR Methods in Policy and Governance	3	0	0	3
MCL368	Quality and Reliability Engineering	3	0	0	3
MCL370	Special Topics in Industrial Engineering	3	0	0	3
MCL380	Special Topics in Mechanical Engineering	3	0	0	3
MCV390	Special module in Mechanical Engineering	1	0	0	1
MCD412	B.Tech. Project-II	0	0	14	7
MCL421	Automotive Structural Design	2	0	2	3
MCL422	Design of Brake Systems	2	0	2	3
MCL441	Modelling and Experiments in Heat Transfer	2	0	4	4
MCL442	ThermoFluid Analysis of Biosystems	3	0	0	3
MCL443	Electrochemical Energy Systems	3	0	0	3
MCL705	Experimental Methods	3	0	2	4
MCL721	Automotive Prime Movers	3	0	0	3
MCL722	Mechanical Design of Prime Mover Elements	3	0	0	3
MCL723	Vehicle Dynamics	2	0	2	3
MCL724	Biomechanics of Trauma in Automotive Design	3	0	0	3
MCL725	Design Electronic Assist Systems in Automobiles	3	0	0	3
MCL726	Design of Steering Systems	3	0	0	3
MCL729	Nanomechanics	2	0	2	3
MCL730	Designing with Advanced Materials	3	0	2	4
MCL736*	Automotive Design	3	0	2	4
MCL743	Plant Equipment Design	3	0	0	3
MCL747	Design of Precision Machines	2	0	2	3
MCL749	Mechatronics Product Design	3	0	2	4
MCL750	Product Design and Manufacturing	1	0	4	3
MCL753	Manufacturing Informatics	3	0	2	4
MCL755	Service System Design	3	0	0	3
MCL756	Supply Chain Management	3	0	0	3
MCL759	Entrepreneurship	3	0	0	3
MCL760	Project Management	3	0	0	3
MCL776	Advances in Metal Forming	3	0	0	3
MCL777	Machine Tool Design	3	0	2	4
MCL788	Surface Engineering	3	0	2	4
MCL814	Convective Heat Transfer	3	0	0	3
MCL818*	Heating, Ventilating and Air-conditioning	3	0	2	3
MCL865	Advanced Operations Research	3	0	0	3

*with permission of course coordinator only

Semester	Course-1	Course-2	Course-3	Course-4	Course-5	Course-6	Course-7	Course-8	Course-9	Course-10	L	T	P	Credits	Non-Graded Units	Contact Hours
I	ELL101 Introduction to Electrical Engineering	ELP101 Introduction to Electrical Engineering (Lab.)	MCP100 Introduction to Engineering Visualization	PYL101 Electromagnetism & Quantum Mechanics	MTL100 Calculus	PYP100 Physics Laboratory	MCP101 Product Realization through Manufacturing	NIN100 Introduction to Engineering (Non-graded)	NEN100 Professional Ethics and Social Responsibility-1 (Non-graded)	NLN100 Language and Writing Skills-1 (Non-Graded)						
	3 1 0 4	0 0 2 1	0 0 4 2	3 1 0 4	3 1 0 4	0 0 4 2	0 0 4 2	0 0 2 1	0 0 1 1	0 0 2 1	9.0	3	14	19.0	2.5	31.0
II	APL100 Engineering Mechanics	COL100 Introduction to Computer Science	CML101 Introduction to Chemistry	MTL101 Linear Algebra and Differential Equations	CMP100 Chemistry Laboratory			NEN101 Professional Ethics and Social Responsibility-2 (Non-graded)	NLN101 Language and Writing Skills-2 (Non-Graded)							
	3 1 0 4	3 0 2 4	3 1 0 4	3 1 0 4	0 0 4 2			0 0 1 0.5	0 0 2 1	12	3	6	18.0	1.5	24.0	
Note: Courses 1-6 above are attended in the given order by half of all first year students. The other half of First year students attend the Courses 1-6 of II semester first.																
III	MLL100 Introduction to Materials Science and Engineering	APL106 Fluid Mechanics	APL104 Solid Mechanics	MCL140 Engineering Thermodynamics	MCL111 Kinematics and Dynamics of Machines											
	3 0 2 4	3 1 0 4	3 1 0 4	3 1 0 4	3 0 2 4											
IV	SBL100 Introductory Biology for Engineers	MCL131 Manufacturing Processes-I	MCL241 Energy systems and Technologies	MTL108 Introduction to Statistics	MCL201 Mechanical Engineering Drawing	HUL2XX										
	3 0 2 4	3 0 0 3	3 0.5 1 4	3 1 0 4	2 0 3 3.5	3 1 0 4										
V	MCL261 Introduction to Operations Research	MCL231 Manufacturing Processes-II	MCL242 Heat and Mass Transfer	MTL107 Numerical Methods and Computations	MCL211 Design of Machines	MCP231 Manufacturing Laboratory-I	HUL2XX									
	3 0 0 3	3 0 0 3	3 1 0 4	3 0 0 4	3 0 2 4	0 0 2 1	3 1 0 4									
VI	MCL361 Manufacturing System Design	MCL212 Control theory and applications	MCL311 CAD and Finite Element Analysis	MCP301 Mechanical Engineering Lab-I	MCP331 Manufacturing Laboratory-II	CVL100 Environmental Science	HUL2XX									
	3 0 0 3	3 0 2 4	3 0 2 4	0 0 3 1.5	0 0 2 1	2 0 0 2	3 1 0 4									
VII	MCL431 CAM and Automation	MCD411 B.Tech.Project	DE 1 (3)	OC 1 (3)	MCP401 Mechanical Engineering Lab-II	DE 2 (3)										
	2 0 2 3	0 0 8 4	3 0 0 3	3 0 0 3	0 0 4 2	3 0 0 3										
VIII	DE 3 (3)	OC 2 (3)	OC 3 (4)	DE 4 (3)	HUL3XX											
	3 0 0 3	3 0 0 3	3 1 0 4	3 0 0 3	3 0 0 3											
											15.0	1	0	16.0	0	16.0
TOTAL=155.0																

Bachelor of Technology in Production and Industrial Engineering

Department of Mechanical Engineering

The overall Credit Structure

Course Category	Credits
Institute Core Courses	
Basic Sciences (BS)	24
Engineering Arts and Science (EAS)	19
Humanities and Social Sciences (HuSS)	15
Programme-linked Courses	11
Departmental Courses	
Departmental Core	66
Departmental Electives	12
Open Category Courses	10
Total Graded Credit requirement	157
Non Graded Units	11

Institute Core : Basic Sciences

CML101	Introduction to Chemistry	3	1	0	4
CMP100	Chemistry Laboratory	0	0	4	2
MTL100	Calculus	3	1	0	4
MTL101	Linear Algebra and Differential Equations	3	1	0	4
PYL101	Electromagnetism & Quantum Mechanics	3	1	0	4
PYP100	Physics Laboratory	0	0	4	2
SBL100	Introductory Biology for Engineers	3	0	2	4
Total Credits		24			

Institute Core: Engineering Arts and Sciences

APL100	Engineering Mechanics	3	1	0	4
COL100	Introduction to Computer Science	3	0	2	4
CVL100	Environmental Science	2	0	0	2
ELL101	Introduction to Electrical Engineering	3	1	0	4
ELP101	Introduction to Electrical Engineering (Lab.)	0	0	2	1
MCP100	Introduction to Engineering Visualization	0	0	4	2
MCP101	Product Realization through Manufacturing	0	0	4	2
Total Credits		19			

Programme-Linked Basic/Engineering Arts/Sciences Core

MLL100	Introduction to Materials Science and Engg.*	3	0	2	4
MTL107	Numerical Methods and Computations	3	0	0	3
MTL108	Introduction to Statistics	3	1	0	4
Total Credits		11			

* APL102 is superseded by MLL100

Humanities and Social Sciences

Courses from Humanities, Social Sciences and Management offered under this category	15
---	-----------

Departmental Core

APL 104	Solid Mechanics	3	1	0	4
MCL111	Kinematics and Dynamics of Machines	3	0	2	4
MCL132	Metal Forming and Press Tools	3	0	0	3
MCL133	Near Net Shape Manufacturing	3	0	0	3
MCL134	Metrology and Quality Assurance	3	0	1	3.5
MCL135	Welding and Allied Processes	3	0	0	3
MCL136	Material Removal Processes	3	0	0	3
MCL141	Thermal Science for Manufacturing	3	1	0	4
MCL201	Mechanical Engineering Drawing	2	0	3	3.5
MCL211	Design of Machines	3	0	2	4
MCL212	Control Theory and Applications	3	0	2	4
MCP232	Production Engineering Laboratory-I	0	0	2	1
MCL261	Introduction to Operations Research	3	0	0	3
MCP261	Industrial Engineering Laboratory-I	0	0	2	1
MCL262	Stochastic Modelling and Simulation	3	0	0	3
MCL311	CAD and Finite Element Analysis	3	0	2	4
MCL331	Micro and Nano Manufacturing	3	0	0	3

MCP332	Production Engineering Laboratory-II	0	0	2	1
MCL361	Manufacturing System Design	3	0	0	3
MCP361	Industrial Engineering Laboratory-II	0	0	2	1
MCD411	B.Tech. Project	0	0	8	4
MCL431	CAM and Automation	2	0	2	3
Total Credits		66			

Departmental Electives

MCD310	Mini Project	0	0	6	3
MCL314	Acoustics and Noise Control	3	0	2	4
MCL321	Automotive Systems	3	0	2	4
MCL322	Power Train Design	3	0	0	3
MCL330	Special Topics Production Engg.	3	0	0	3
MCL334	Industrial Automation	3	0	2	4
MCL336	Advances in Welding	3	0	2	4
MCL337	Advanced Machining Processes	3	0	0	3
MCL338	Mechatronic Applications in Manufacturing	3	0	2	4
MCL341	Gas Dynamics and Propulsion	3	0	2	4
MCL343	Introduction to Combustion	3	0	0	3
MCL344	Refrigeration and Air-conditioning	3	0	2	4
MCL345	Reciprocating Internal Combustion Engines	3	0	2	4
MCL347	Intermediate Heat Transfer	3	0	0	3
MCL348	Thermal Management of Electronics	3	0	0	3
MCL350	Mechanical Engineering Product Synthesis	1	0	2	2
MCL363	Investment Planning	3	0	0	3
MCL364	Value Engineering	3	0	2	4
MCL366	OR Methods in Policy and Governance	3	0	0	3
MCL368	Quality and Reliability Engineering	3	0	0	3
MCL370	Special Topics in Industrial Engg.	3	0	0	3
MCL380	Special Topics in Mechanical Engineering	3	0	0	3
MCV390	Special module in Mechanical Engineering	1	0	0	1
MCD412	B.Tech. Project-II	0	0	14	7
MCL421	Automotive Structural Design	2	0	2	3
MCL422	Design of Brake Systems	2	0	2	3
MCL441	Modelling and Experiments in Heat Transfer	2	0	4	4
MCL442	Thermofluid Analysis of Biosystems	3	0	0	3
MCL443	Electrochemical Energy Systems	3	0	0	3
MCL705	Experimental Methods	3	0	2	4
MCL721	Automotive Prime Movers	3	0	0	3
MCL722	Mechanical Design of Prime Mover Elements	3	0	0	3
MCL723	Vehicle Dynamics	2	0	2	3
MCL724	Biomechanics of Trauma in Automotive Design	3	0	0	3
MCL725	Design Electronic Assist Systems in Automobiles	3	0	0	3
MCL726	Design of Steering Systems	3	0	0	3
MCL729	Nanomechanics	2	0	2	3
MCL730	Designing with advanced materials	3	0	2	4
MCL736*	Automotive Design	3	0	2	4
MCL743	Plant Equipment Design	3	0	0	3
MCL747	Design of Precision Machines	2	0	2	3
MCL749	Mechatronics Product Design	3	0	2	4
MCL750	Product Design and Manufacturing	1	0	4	3
MCL753	Manufacturing Informatics	3	0	2	4
MCL755	Service System Design	3	0	0	3
MCL756	Supply Chain Management	3	0	0	3
MCL759	Entrepreneurship	3	0	0	3
MCL760	Project Management	3	0	0	3
MCL776	Advances in Metal Forming	3	0	0	3
MCL777	Machine Tool Design	3	0	2	4
MCL788	Surface Engineering	3	0	2	4
MCL814	Convective Heat Transfer	3	0	0	3
MCL818*	Heating, Ventilating and Air-conditioning	3	0	2	3
MCL865	Advanced Operations Research	3	0	0	3

*with permission of course coordinator only

Semester	Course-1	Course-2	Course-3	Course-4	Course-5	Course-6	Course-7	Course-8	Course-9	Course-10	L	T	P	Credits	Non-Graded Units	Contact Hours
I	ELL101 Introduction to Electrical Engineering	ELPT01 Introduction to Electrical Engineering (Lab.)	MCP100 Introduction to Engineering Visualization	PYL101 Electromagnetism & Quantum Mechanics	MTL100 Calculus	PYP100 Physics Laboratory	MCP101 Product Realization through Manufacturing	NIN100 Introduction to Engineering (Non-graded)	NEEN100 Professional Ethics and Social Responsibility-1 (Non-graded)	NLN100 Language and Writing Skills-1 (Non-Graded)						
	APL100 Engineering Mechanics	COL100 Introduction to Computer Science	CML101 Introduction to Chemistry	MTL101 Linear Algebra and Differential Equations	CMP100 Chemistry Laboratory			NEEN101 Professional Ethics and Social Responsibility-2 (Non-graded)	NLN101 Language and Writing Skills-2 (Non-Graded)		9.0	3	14	19.0	2.5	31.0
	3 1 0 4	0 0 2 1	0 0 4 2	3 1 0 4	3 1 0 4	0 0 4 2	0 0 4 2	0 0 2 1	0 0 1 0.5	0 0 2 1	0 0 2 1					
II											12	3	6	18.0	1.5	24.0
Note: Courses 1-6 above are attended in the given order by half of all first year students. The other half of First year students attend the Courses 1-6 of II semester first.																
III	MLL100 Introduction to Materials Science and Engineering	APL 104 Solid Mechanics	MCL141 Thermal Science for Manufacturing	MCL111 Kinematics and Dynamics of Machines	HUL2XX											
	3 0 2 4	3 1 0 4	3 1 0 4	3 0 2 4	3 1 0 4						15.0	3	4	20.0	0	22.0
IV	SBL100 Introductory Biology for Engineers	MCL132 Metal Forming and Press Tools	MCL133 Near Net Shape Manufacturing	MTL108 Introduction to Statistics	MCL201 Mechanical Engineering Drawing	HUL2XX										
	3 0 2 4	3 0 0 3	3 0 0 3	3 1 0 4	2 0 3 3.5	3 1 0 4					17.0	2	5	21.5	0	24.0
V	MCL261 Introduction to Operations Research	MCL134 Metrology and Quality Assurance	MCL135 Welding and Allied Processes	MTL107 Numerical Methods and Computations	MCL211 Design of Machines	MCP232 Production Engineering Laboratory-I	MCL262 Stochastic Modelling and Simulation									
	3 0 0 3	3 0 1 3.5	3 0 0 3	3 0 0 3	3 0 2 4	0 0 2 1	3 0 0 3				18.0	0	5	20.5	0	23.0
VI	MCL361 Manufacturing System Design	MCL212 Control theory and applications	MCL311 CAD and Finite Element Analysis	MCP261 Industrial Engineering Laboratory-I	MCP332 Production Engineering Laboratory-II	MCL136 Material Removal Processes	MCL331 Micro and Nano Manufacturing	CVL100 Environmental Science								
	3 0 0 3	3 0 2 4	3 0 2 4	0 0 2 1	0 0 2 1	3 0 0 3	3 0 0 3	2 0 0 2			17.0	0	8	21.0	0	25.0
VII	MCL431 CAM and Automation	MCD411 B.Tech.Project	MCP361 Industrial Engineering Laboratory-II	OC 1 (3)	HUL2XX	DE 1 (3)										
	2 0 2 3	0 0 8 4	0 0 2 1	3 0 0 3	3 1 0 4	3 0 0 3					11.0	1	12	18.0	0	24.0
VIII	DE 2 (3)	OC 2 (3)	OC 3 (4)	DE 3 (3)	HUL3XX	DE 4 (3)										
	3 0 0 3	3 0 0 3	3 1 0 4	3 0 0 3	3 0 0 3	3 0 0 3					18.0	1	0	19.0	0	19.0
															TOTAL=157.0	

Bachelor of Technology in Mathematics and Computing

Department of Mathematics

The overall Credit Structure

Course Category	Credits
Institute Core Courses	
Basic Sciences (BS)	24
Engineering Arts and Science (EAS)	19
Humanities and Social Sciences (HuSS)	15
Programme-linked Courses	12.5
Departmental Courses	
Departmental Core	63.5
Departmental Electives	12
Open Category Courses	10
Total Graded Credit requirement	156
Non Graded Units	11

Institute Core : Basic Sciences

CML101	Introduction to Chemistry	3	1	0	4
CMP100	Chemistry Laboratory	0	0	4	2
MTL100	Calculus	3	1	0	4
MTL101	Linear Algebra and Differential Equations	3	1	0	4
PYL101	Electromagnetism & Quantum Mechanics	3	1	0	4
PYP100	Physics Laboratory	0	0	4	2
SBL100	Introductory Biology for Engineers	3	0	2	4
Total Credits		24			

Institute Core: Engineering Arts and Sciences

APL100	Engineering Mechanics	3	1	0	4
COL100	Introduction to Computer Science	3	0	2	4
CVL100	Environmental Science	2	0	0	2
ELL101	Introduction to Electrical Engineering	3	1	0	4
ELP101	Introduction to Electrical Engineering (Lab.)	0	0	2	1
MCP100	Introduction to Engineering Visualization	0	0	4	2
MCP101	Product Realization through Manufacturing	0	0	4	2
Total Credits		19			

Programme-Linked Basic/Engineering Arts/Sciences Core

COL106	Data Structures and Algorithms	3	0	4	5
ELL201	Digital Electronics	3	0	3	4.5
PYL102	Principles of Electronic Materials	3	0	0	3
Total Credits		12.5			

Departmental Core

ELL305	Computer Architecture	3	0	0	3
ELP305	Design and System Laboratory	0	0	3	1.5
MTL102	Differential Equations	3	0	0	3
MTL103	Optimization Methods and Applications	3	0	0	3
MTL104	Linear Algebra and Applications	3	0	0	3
MTL105	Algebra	3	0	0	3
MTL106	Probability and Stochastic Processes	3	1	0	4
MTL107	Numerical Methods and Computations	3	0	0	3
MTL122	Real and Complex Analysis	3	1	0	4
MTL180	Discrete Mathematical Structures	3	1	0	4
MTP290	Computing Laboratory	0	0	4	2
MTL342	Analysis and Design of Algorithms	3	1	0	4
MTL390	Statistical Methods	3	1	0	4
MTD411	B.Tech. Project	0	0	8	4
MTL421	Functional Analysis	3	0	0	3
MTL445	Computational Methods for Differential Equations	3	0	2	4
MTL458	Operating Systems	3	0	2	4
Total Credits		63.5			

Departmental Electives

COL334	Computer Networks	3	0	2	4
COL728	Compiler Design	3	0	3	4.5
ELL365	Embedded Systems	3	0	0	3
ELL715	Digital Image Processing	3	0	2	4

ELL786	Multimedia Systems	3	0	0	3
ELL789	Intelligent Systems	3	0	0	3
ELL792	Computer Graphics	3	0	0	3
ELL793	Computer Vision	3	0	0	3
ELL884	Information Retrieval	3	0	0	3
MTL145	Number Theory	3	0	0	3
MTL146	Combinatorics	3	0	0	3
MTL260	Boundary Value Problems	3	0	0	3
MTL265	Mathematical Programming Techniques	3	0	0	3
MTL270	Measure Integral and Probability	3	0	0	3
MTD350	Mini Project	0	0	6	3
MTL415	Parallel Algorithms	3	0	0	3
MTL704	Numerical Optimization	3	0	0	3
MTL717	Fuzzy Sets and Applications	3	0	0	3
MTL720	Neurocomputing and Applications	3	0	0	3
MTL725	Stochastic Processes and its Applications	3	0	0	3
MTL728	Category Theory	3	0	0	3
MTL729	Computational Algebra and its Applications	3	0	0	3
MTL730	Cryptography	3	0	0	3
MTL731	Introduction to Chaotic Dynamical Systems	3	0	0	3
MTL732	Financial Mathematics	3	0	0	3
MTL733	Stochastic of Finance	3	0	0	3
MTL735	Advanced Number Theory	3	0	0	3
MTL738	Commutative Algebra	3	0	0	3
MTL739	Representation of Finite Groups	3	0	0	3
MTL741	Fractal Geometry	3	0	0	3
MTL742	Operator Theory	3	0	0	3
MTL743	Fourier Analysis	3	0	0	3
MTL744	Mathematical Theory of Coding	3	0	0	3
MTL745	Advanced Matrix Theory	3	0	0	3
MTL747	Mathematical Logic	3	0	0	3
MTL751	Symbolic Dynamics	3	0	0	3
MTL754	Principles of Computer Graphics	3	0	0	3
MTL755	Algebraic Geometry	3	0	0	3
MTL756	Lie Algebras and Lie Groups	3	0	0	3
MTL757	Introduction to Algebraic Topology	3	0	0	3
MTL760	Advanced Algorithms	3	0	0	3
MTL761	Basic Ergodic Theory	3	0	0	3
MTL762	Probability Theory	3	0	0	3
MTL763	Introduction to Game Theory	3	0	0	3
MTL766	Multivariate Statistical Methods	3	0	0	3
MTL768	Graph Theory	3	0	0	3
MTL773	Wavelets and Applications	3	0	0	3
MTL781	Finite Element Theory and Applications	3	0	0	3
MTL785	Natural Language Processing	3	0	0	3
MTL792	Modern Methods in Partial Differential equations	3	0	0	3
MTL793	Numerical Methods for Hyperbolic PDEs	3	0	0	3
MTL794	Advanced Probability Theory	3	0	0	3
MTL795	Numerical Method for Partial Differential Equations	3	1	0	4
MTL799	Mathematical Analysis in Learning Theory	3	0	0	3
MTV791	Special Module in Dynamical System	1	0	0	1
MTL811	Mathematical Foundation of Artificial Intelligence	3	0	0	3
MTL843	Mathematical Modeling of Credit Risk	3	0	0	3
MTL851	Applied Numerical Analysis	3	0	0	3
MTL854	Interpolation and Approximation	3	0	0	3
MTL855	Multiple Decision Procedures in Ranking and Selection	3	0	0	3
MTL860	Linear Algebra	3	0	0	3
MTL863	Algebraic Number Theory	3	0	0	3
MTV874	Analysis	3	0	0	3
MTL882	Applied Analysis	3	0	0	3
MTL883	Physical Fluid Mechanics	3	0	0	3
MTL888	Boundary Elements Methods with Computer Implementation	3	0	0	3

Semester	Course-1	Course-2	Course-3	Course-4	Course-5	Course-6	Course-7	Course-8	Course-9	Course-10	L	T	P	Credits	Non-Graded Units	Contact Hours	
I	ELL101 Introduction to Electrical Engineering	ELP101 Introduction to Electrical Engineering (Lab.)	MCP100 Introduction to Engineering Visualization	PYL101 Electromagnetism & Quantum Mechanics	MTL100 Calculus	PYP100 Physics Laboratory	MCP101 Product Realization through Manufacturing	NIN100 Introduction to Engineering (Non-graded)	NEN100 Professional Ethics and Social Responsibility-1 (Non-graded)	NLN100 Language and Writing Skills-1 (Non-Graded)	9	0	3	14	19.0	2.5	31.0
	APL100 Engineering Mechanics	COL100 Introduction to Computer Science	CML101 Introduction to Chemistry	MTL101 Linear Algebra and Differential Equations	CMP100 Chemistry Laboratory			NEN101 Professional Ethics and Social Responsibility-2 (Non-graded)	NLN101 Language and Writing Skills-2 (Non-Graded)		0	0	2	1	0	0	2
II	3 1 0 4	3 0 2 4	3 1 0 4	3 1 0 4	3 0 0 4	0 0 4 2		0 0 1	0 0 1	0 0 2 1	12	3	6	18.0	1.5	24.0	
	Engineering Mechanics	Introduction to Computer Science	Introduction to Chemistry	Linear Algebra and Differential Equations	Chemistry Laboratory			Professional Ethics and Social Responsibility-2 (Non-graded)	Language and Writing Skills-2 (Non-Graded)								
Note: Courses 1-6 above are attended in the given order by half of all first year students. The other half of First year students attend the Courses 1-6 of II semester first.																	
III	COL106 Data Structures & Algorithms	MTL180 Discrete Mathematical Structures	PYL102 Principles of Electronic Materials	CVL100 Environmental Science	MTL104 Linear Algebra and Applications	HUL2XX HUL2XX											
	3 0 4 5	3 1 0 4	3 0 0 3	2 0 0 2	3 0 0 3	3 1 0 4					17	2	4	21.0	0	23.0	
IV	MTL122 Real and Complex Analysis	ELL201 Digital Electronics	MTL103 Optimization Methods and Applications	SBL100 Introduction to Biology for Engineers	MTP290 Computing Laboratory	HUL2XX HUL2XX											
	3 1 0 4	3 0 3 4.5	3 0 0 3	3 0 2 4	0 0 4 2	3 1 0 4					15	2	9	21.5	0	26.0	
V	MTL106 Probability and Stochastic Processes	ELL305 Computer Architecture	MTL105 Algebra	MTL107 Numerical Methods and Computation	MTL342 Analysis and Design of Algorithms	HUL2XX HUL2XX											
	3 1 0 4	3 0 0 3	3 0 0 3	3 0 0 3	3 1 0 4	3 1 0 4					18	3	0	21.0	0	21.0	
VI	MTL102 Differential Equations	MTL782 Data Mining	MTL390 Statistical Methods	MTL411 Functional Analysis	DE 1 DE 1	ELP305 Design and System Laboratory											
	3 0 0 3	3 0 2 4	3 1 0 4	3 0 0 3	3 0 0 3	0 0 3 1.5					15	1	5	18.5	0	21.0	
VII	MTL712 Computational Methods for Differential Equations	MTL783 Theory of Computation	DE 2 DE 2	MTL456 Operating Systems	OC 1 OC 1	HUL3XX HUL3XX											
	3 0 2 4	3 0 0 3	3 0 0 3	3 0 2 4	3 0 0 3	3 0 0 3					18	0	4	20.0	0	22.0	
VIII	OC 2 OC 2	OC 3 OC 3	DE 3 DE 3	DE 4 DE 4	MTD421 B.Tech. Project												
	3 1 0 4	3 0 0 3	3 0 0 3	3 0 0 3	0 0 8 4						12	1	8	17.0	0	21.0	
															TOTAL=156.0		

Dual Degree Programme: Bachelor of Technology and Master of Technology in Mathematics and Computing

Department of Mathematics

The overall Credit Structure

Course Category	Credits
Institute Core Courses	
Basic Sciences (BS)	24
Engineering Arts and Science (EAS)	19
Humanities and Social Sciences (HuSS)	15
Programme-linked Courses	12.5
Departmental Courses	
Departmental Core	59.5
Departmental Electives	6
Open Category Courses	12
Total B.Tech. Credit requirement	148
Non Graded Units	11
M.Tech. Part	
Programme Core Courses	24
Programme Electives Courses	18
Total M.Tech. Requirement	42
Total Graded Requirement	190

Institute Core : Basic Sciences

CML101	Introduction to Chemistry	3	1	0	4
CMP100	Chemistry Laboratory	0	0	4	2
MTL100	Calculus	3	1	0	4
MTL101	Linear Algebra and Differential Equations	3	1	0	4
PYL101	Electromagnetism & Quantum Mechanics	3	1	0	4
PYP100	Physics Laboratory	0	0	4	2
SBL100	Introductory Biology for Engineers	3	0	2	4
Total Credits					24

Institute Core: Engineering Arts and Sciences

APL100	Engineering Mechanics	3	1	0	4
COL100	Introduction to Computer Science	3	0	2	4
CVL100	Environmental Science	2	0	0	2
ELL101	Introduction to Electrical Engineering	3	1	0	4
ELP101	Introduction to Electrical Engineering (Lab.)	0	0	2	1
MCP100	Introduction to Engineering Visualization	0	0	4	2
MCP101	Product Realization through Manufacturing	0	0	4	2
Total Credits					19

Programme-Linked Basic/Engineering Arts/Sciences Core

COL106	Data Structures and Algorithms	3	0	4	5
ELL201	Digital Electronics	3	0	3	4.5
PYL102	Principles of Electronic Materials	3	0	0	3
Total Credits					12.5

Humanities and Social Sciences

Courses from Humanities, Social Sciences and Management offered under this category					15
---	--	--	--	--	-----------

Departmental Core

ELL305	Computer Architecture	3	0	0	3
ELP305	Design and System Laboratory	0	0	3	1.5
MTL102	Differential Equations	3	0	0	3
MTL103	Optimization Methods and Applications	3	0	0	3
MTL104	Linear Algebra and Applications	3	0	0	3
MTL105	Algebra	3	0	0	3
MTL106	Probability and Stochastic Processes	3	1	0	4
MTL107	Numerical Methods and Computations	3	0	0	3
MTL122	Real and Complex Analysis	3	1	0	4
MTL180	Discrete Mathematical Structures	3	1	0	4
MTP290	Computing Laboratory	0	0	4	2
MTL342	Analysis and Design of Algorithms	3	1	0	4
MTL783	Theory of Computation	3	0	0	3
MTL390	Statistical Methods	3	1	0	4
MTL411	Functional Analysis	3	0	0	3
MTL445	Computational Methods for Differential Equations	3	0	2	4
MTL458	Operating Systems	3	0	2	4

MTL712	Computational Methods for Differential Equations	3	0	2	4
MTL782	Data Mining	3	0	2	4
Total Credits					63.5

Departmental Electives

COL334	Computer Networks	3	0	2	4
ELL365	Embedded Systems	3	0	0	3
MTL145	Number Theory	3	0	0	3
MTL146	Combinatorics	3	0	0	3
MTL260	Boundary Value Problems	3	0	0	3
MTL265	Mathematical Programming Techniques	3	0	0	3
MTL270	Measure Integral and Probability	3	0	0	3
MTD350	Mini Project	0	0	6	3
MTL415	Parallel Algorithms	3	0	0	3
MTL768	Graph Theory	3	0	0	3
MTL773	Wavelets and Applications	3	0	0	3
MTL799	Mathematical Analysis in Learning Theory	3	0	0	3

Programme Core

MTL766	Multivariate Statistical Methods	3	0	0	3
MTL781	Finite Elements and Applications	3	0	0	3
MTD851	Major Project Part-I (MT)	0	0	12	6
MTD852	Major Project Part-II (MT)	0	0	24	12
MTD853*	Major Project Part-I	0	0	8	4
MTD854*	Major Project Part-II	0	0	28	14
Total Credits					22

*MTD853 and MTD854 together are alternatives to MTD851 and MTD852

Programme Electives

COL728	Compiler Design	3	0	3	4.5
ELL715	Digital Image Processing	3	0	2	4
ELL786	Multimedia Systems	3	0	0	3
ELL789	Intelligent Systems	3	0	0	3
ELL792	Computer Graphics	3	0	0	3
ELL793	Computer Vision	3	0	0	3
ELL884	Information Retrieval	3	0	0	3
MTL704	Numerical Optimization	3	0	0	3
MTL717	Fuzzy Sets and Applications	3	0	0	3
MTL720	Neurocomputing and Applications	3	0	0	3
MTL725	Stochastic Processes and its Applications	3	0	0	3
MTL728	Category Theory	3	0	0	3
MTL729	Computational Algebra and its Applications	3	0	0	3
MTL730	Cryptography	3	0	0	3
MTL731	Introduction to Chaotic Dynamical Systems	3	0	0	3
MTL732	Financial Mathematics	3	0	0	3
MTL733	Stochastic of Finance	3	0	0	3
MTL735	Advanced Number Theory	3	0	0	3
MTL738	Commutative Algebra	3	0	0	3
MTL739	Representation of Finite Groups	3	0	0	3
MTL741	Fractal Geometry	3	0	0	3
MTL742	Operator Theory	3	0	0	3
MTL743	Fourier Analysis	3	0	0	3
MTL744	Mathematical Theory of Coding	3	0	0	3
MTL745	Advanced Matrix Theory	3	0	0	3
MTL747	Mathematical Logic	3	0	0	3
MTL751	Symbolic Dynamics	3	0	0	3
MTL754	Principles of Computer Graphics	3	0	0	3
MTL755	Algebraic Geometry	3	0	0	3
MTL756	Lie Algebras and Lie Groups	3	0	0	3
MTL757	Introduction to Algebraic Topology	3	0	0	3
MTL760	Advanced Algorithms	3	0	0	3
MTL761	Basic Ergodic Theory	3	0	0	3
MTL762	Probability Theory	3	0	0	3
MTL763	Introduction to Game Theory	3	0	0	3

MTL785	Natural Language Processing	3	0	0	3	MTL851	Applied Numerical Analysis	3	0	0	3
MTL792	Modern Methods in Partial Differential equations	3	0	0	3	MTL854	Interpolation and Approximation	3	0	0	3
MTL793	Numerical Methods for Hyperbolic PDEs	3	0	0	3	MTL855	Multiple Decision Procedures in Ranking and Selection	3	0	0	3
MTL794	Advanced Probability Theory	3	0	0	3	MTL860	Linear Algebra	3	0	0	3
MTL795	Numerical Method for Partial Differential Equations	3	1	0	4	MTL863	Algebraic Number Theory	3	0	0	3
MTV791	Special Module in Dynamical System	1	0	0	1	MTV874	Analysis	3	0	0	3
MTL811	Mathematical Foundation of Artificial Intelligence	3	0	0	3	MTL882	Applied Analysis	3	0	0	3
MTL843	Mathematical Modeling of Credit Risk	3	0	0	3	MTL883	Physical Fluid Mechanics	3	0	0	3
						MTL888	Boundary Elements Methods with Computer Implementation	3	0	0	3

Semester	Course-1	Course-2	Course-3	Course-4	Course-5	Course-6	Course-7	Course-8	Course-9	Course-10	L	T	P	Credits	Non-Graded Units	Contact Hours	
I	ELL101 Introduction to Electrical Engineering	ELP101 Introduction to Electrical Engineering (Lab.)	MCP100 Introduction to Engineering Visualization	PYL101 Electromagnetism & Quantum Mechanics	MTL100 Calculus	PYP100 Physics Laboratory	MCP101 Product Realization through Manufacturing	NIN100 Introduction to Engineering (Non-graded)	NEI100 Professional Ethics and Social Responsibility-1 (Non-graded)	NLN100 Language and Skills-1 (Non-Graded)	9	0	3	14	19.0	2.5	31
	3 1 0 4	0 0 2 1	0 0 4 2	3 1 0 4	3 1 0 4	0 0 4 2	0 0 4 2	0 0 2 1	0 0 1 0.5	0 0 2 1							
	APL100 Engineering Mechanics	COL100 Introduction to Computer Science	CML101 Introduction to Chemistry	MTL101 Linear Algebra and Differential Equations	CMP100 Chemistry Laboratory			NEI101 Professional Ethics and Social Responsibility-2 (Non-graded)	NLN101 Language and Writing Skills-2 (Non-Graded)								
II	3 1 0 4	3 0 2 4	3 1 0 4	3 1 0 4	0 0 4 2			0 0 1 0.5	0 0 2 1		12	3	6	18.0	1.5	24	
	Note: Courses 1-6 above are attended in the given order by half of all first year students. The other half of First year students attend the Courses 1-6 of II semester first.																
III	COL106 Data Structures & Algorithms	MTL180 Discrete Mathematical Structures	PYL102 Principles of Electronic Materials	CVL100 Environmental Science	MTL104 Linear Algebra and Applications	HUL2XX											
	3 0 4 5	3 1 0 4	3 0 0 3	2 0 0 2	3 0 0 3	3 1 0 4											
IV	MTL122 Real and Complex Analysis	ELL201 Digital Electronics	MTL103 Optimization Methods and Applications	SBL100 Introduction to Biology for Engineers	MTP290 Computing Laboratory	HUL2XX											
	3 1 0 4	3 0 3 4.5	3 0 0 3	3 0 2 4	0 0 4 2	3 1 0 4											
V	MTL106 Probability and Stochastic Processes	ELL305 Computer Architecture	MTL105 Algebra	MTL107 Numerical Methods and Computation	MTL342 Analysis and Design of Algorithms	HUL2XX											
	3 1 0 4	3 0 0 3	3 0 0 3	3 0 0 3	3 1 0 4	3 1 0 4											
VI	MTL102 Differential Equations	MTL782 Data Mining	MTL390 Statistical Methods	MTL411 Functional Analysis	DE 1	ELP305 Design and System Laboratory											
	3 0 0 3	3 0 2 4	3 1 0 4	3 0 0 3	3 0 0 3	0 0 3 1.5											
VII	MTL112 Computational Methods for Differential Equations	MTL783 Theory of Computation	DE 2	MTL458 Operating Systems	OC 1	HUL3XX											
	3 0 2 4	3 0 0 3	3 0 0 3	3 0 2 4	3 0 0 3	3 0 0 3											
VIII	OC 2	OE 1	PE 1	PE 2	PE 3	PE 4											
	3 0 0 3	3 0 0 3	3 0 0 3	3 0 0 3	3 0 0 3	3 0 0 3											
IX	MTD851	MTL781 Finite Elements Theory and Applications	MTL766 Multivariate Statistical Methods	PE 5	PE 6	OE 2											
	0 0 12 6	3 0 0 3	3 0 0 3	3 0 0 3	3 0 0 3	3 0 0 3											
X	MTD852																
	0 0 24 12																
											0	0	24	12	0	24	
TOTAL=190.0																	

Bachelor of Technology in Engineering Physics

Department of Physics

The overall Credit Structure

Course Category	Credits
Institute Core Courses	
Basic Sciences (BS)	24
Engineering Arts and Science (EAS)	19
Humanities and Social Sciences (HuSS)	15
Programme-linked Courses	14.5
Departmental Courses	
Departmental Core	58
Departmental Electives	12
Open Category Courses	10
Total Graded Credit requirement	152.5
Non Graded Units	11

PYL125	Solid State Physics I	3	1	0	4
PYL127	Classical Mechanics & Relativity	3	1	0	4
PYL202	Statistical Physics	3	1	0	4
PYL204	Computational Physics	3	1	0	4
PYL205	Electrodynamics	3	1	0	4
PYL206	Mathematical Physics II	3	1	0	4
PYL208	Solid State Physics II	3	0	0	3
PYL209	Optics and Photonics II	3	0	0	3
PYP212	Engineering Physics Laboratory-II	0	0	6	3
PYP221	Engineering Physics Laboratory-III	0	0	6	3
PYP222	Engineering Physics Laboratory-IV	0	0	6	3
PYD411	Project-I	0	0	8	4
Total Credits					58

Institute Core : Basic Sciences

CML101	Introduction to Chemistry	3	1	0	4
CMP100	Chemistry Laboratory	0	0	4	2
MTL100	Calculus	3	1	0	4
MTL101	Linear Algebra and Differential Equations	3	1	0	4
PYL101	Electromagnetism & Quantum Mechanics	3	1	0	4
PYP100	Physics Laboratory	0	0	4	2
SBL100	Introductory Biology for Engineers	3	0	2	4
Total Credits					24

Institute Core: Engineering Arts and Sciences

APL100	Engineering Mechanics	3	1	0	4
COL100	Introduction to Computer Science	3	0	2	4
CVL100	Environmental Science	2	0	0	2
ELL101	Introduction to Electrical Engineering	3	1	0	4
ELP101	Introduction to Electrical Engineering (Lab.)	0	0	2	1
MCP100	Introduction to Engineering Visualization	0	0	4	2
MCP101	Product Realization through Manufacturing	0	0	4	2
Total Credits					19

Programme-Linked Basic/Engineering Arts/Sciences Core

CML102	Chemical Synthesis of Functional Materials	3	0	0	3
ELL201	Digital Electronics	3	0	3	4.5
ELL205	Signals and Systems	3	1	0	4
ESL350	Energy Conservation and Management	3	0	0	3
Total Credits					14.5

Humanities and Social Sciences

Courses from Humanities, Social Sciences and Management offered under this category	15
---	-----------

Departmental Core

PYP111	Engineering Physics Laboratory-I	0	0	6	3
PYL121	Mathematical Physics-I	3	1	0	4
PYL122	Quantum Mechanics	3	1	0	4
PYL123	Optics and Photonics I	3	1	0	4

Departmental Electives

PYS300	Independent Study	0	3	0	3
PYL301	Vacuum Technology & Surface Science	3	0	0	3
PYL302	Nuclear Science and Engineering	3	0	0	3
PYL303	Materials Science and Engineering	3	0	0	3
PYL304	Superconductivity and Applications	3	0	0	3
PYL305	Engineering Applications of Plasmas	3	0	0	3
PYL306	Microelectronic Devices	3	0	0	3
PYL307	Elements of Material Processing	3	0	0	3
PYL311	Lasers	3	0	0	3
PYL312	Semiconductor Optoelectronics	3	0	0	3
PYL313	Fourier Optics and Holography	3	0	0	3
PYL321	Low Dimensional Physics	3	0	0	3
PYL322	Nanoscale Fabrication	3	0	0	3
PYL323	Nanoscale Microscopy	2	0	0	2
PYL324	Spectroscopy of Nanomaterials	2	0	0	2
PYL331	Applied Quantum Mechanics	3	0	0	3
PYL332	General Theory of Relativity & Cosmology	3	0	0	3
PYL411	Quantum Electronics	3	0	0	3
PYD412	Project-II	0	0	16	8
PYL412	Ultrafast Laser Systems and Applications	3	0	0	3
PYL413	Fiber and Integrated Optics	3	0	0	3
PYD414	Project-III	0	0	8	4
PYL414	Engineering Optics	3	0	0	3
PYV418	Selected Topics in Photonics	2	0	0	2
PYV419	Special Topics in Photonics	1	0	0	1
PYL421	Functional Nanostructures	3	0	0	3
PYL422	Spintronics	3	0	0	3
PYL423	Nanoscale Energy Materials & Devices	3	0	0	3
PYV428	Selected Topics in Nanotechnology	2	0	0	2
PYV429	Special Topics in Nanotechnology	1	0	0	1
PYL431	Relativistic Quantum Mechanics	2	0	0	2
PYL432	Quantum Electrodynamics	3	0	0	3
PYL433	Introduction to Gauge Field Theories	2	0	0	2
PYL434	Particle Accelerators	2	0	0	2
PYL435	Advanced Computational Physics	2	1	0	3
PYV438	Selected Topics in Theoretical Physics	2	0	0	2
PYV439	Special Topics in Theoretical Physics	1	0	0	1

Semester	Course-1	Course-2	Course-3	Course-4	Course-5	Course-6	Course-7	Course-8	Course-9	Course-10	L	T	P	Credits	Non-Graded Units	Contact Hours	
I	ELL101 Introduction to Electrical Engineering	ELP101 Introduction to Electrical Engineering (Lab.)	MCP100 Introduction to Engineering Visualization	PYL101 Electromagnetism & Quantum Mechanics	MTL100 Calculus	PYP100 Physics Laboratory	MCP101 Product Realization through Manufacturing	NIN100 Introduction to Engineering (Non-Graded)	NEN100 Professional Ethics and Social Responsibility-1 (Non-Graded)	NLN100 Language and Writing Skills-1 (Non-Graded)	9	0	3	14	19.0	2.5	31.0
	APL100 Engineering Mechanics	COL100 Introduction to Computer Science	CML101 Introduction to Chemistry	MTL101 Linear Algebra and Differential Equations	CMP100 Chemistry Laboratory			NEN101 Professional Ethics and Social Responsibility-2 (Non-Graded)	NLN101 Language and Writing Skills-2 (Non-Graded)		12	3	6	18.0	1.5	24.0	
	3 1 0 4	3 0 0 2 4	3 1 0 4	3 1 0 4	3 1 0 4	0 0 4 2	0 0 4 2	0 0 1 0.5	0 0 2 1	0 0 2 1	0 0 2 1						
II	PYL203 Classical Mechanics & Relativity	PYL113 Mathematical Physics-I	PYL123 Optics & Photonics-I	PYL125 Solid State Physics-I	HUL2XX	PYL111 Engineering Physics Laboratory-I											
	PYL112 Quantum Mechanics	PYL208 Solid State Physics-II	PYL206 Mathematical Physics-II	ELL201 Digital Electronics	ESL350 Energy Conservation and Management	PYL212 Engineering Physics Laboratory-II					15	5	6	23.0	0	26.0	
	3 1 0 4	3 0 0 3	3 1 0 4	3 0 3 4.5	3 1 0 4	0 0 6 3											
IV	PYL209 Optics & Photonics-II	PYL111 Electrodynamics	ELL205 Signals and Systems	HUL2XX	CML102 Chemical Synthesis of Functional Materials	PYP221 Engineering Physics Laboratory-III											
	3 0 0 3	3 1 0 4	3 1 0 4	3 1 0 4	3 0 0 3	0 0 6 3					15	2	9	21.5	0	26.0	
V	PYL202 Statistical Physics	PYL204 Computational Physics	DE 1	HUL2XX	SBL100 Introductory Biology for Engineers	PYP222 Engineering Physics Laboratory-IV											
	3 1 0 4	3 1 0 4	3 0 0 3	3 1 0 4	3 0 2 4	0 0 6 3					15	3	8	22.0	0	26.0	
VI	DE 2	OC 1	HUL3XX	PYD411 Project I	CVL100 Environmental Science												
	3 0 0 3	3 0 0 3	3 0 0 3	0 0 8 4	2 0 0 2						11	0	8	15.0	0	19.0	
VII	DE 3	DE 4	OC 2	OC 3													
	3 0 0 3	3 0 0 3	3 1 0 4	3 0 0 3							12	1	0	13.0	0	13.0	
VIII																	
<p>Note: Courses 1-6 above are attended in the given order by half of all first year students. The other half of First year students attend the Courses 1-6 of II semester first.</p>																	
															TOTAL=152.5		

Bachelor of Technology in Textile Technology

Department of Textile and Fibre Engineering

The overall Credit Structure

Course Category	Credits
Institute Core Courses	
Basic Sciences (BS)	24
Engineering Arts and Science (EAS)	19
Humanities and Social Sciences (HuSS)	15
Programme-linked Courses	12
Departmental Courses	
Departmental Core	52
Departmental Electives	16
Open Category Courses	10
Total Graded Credit requirement	148
Non Graded Units	11

Institute Core : Basic Sciences

CML101	Introduction to Chemistry	3	1	0	4
CMP100	Chemistry Laboratory	0	0	4	2
MTL100	Calculus	3	1	0	4
MTL101	Linear Algebra and Differential Equations	3	1	0	4
PYL101	Electromagnetism & Quantum Mechanics	3	1	0	4
PYP100	Physics Laboratory	0	0	4	2
SBL100	Introductory Biology for Engineers	3	0	2	4
Total Credits					24

Institute Core: Engineering Arts and Sciences

APL100	Engineering Mechanics	3	1	0	4
COL100	Introduction to Computer Science	3	0	2	4
CVL100	Environmental Science	2	0	0	2
ELL101	Introduction to Electrical Engineering	3	1	0	4
ELP101	Introduction to Electrical Engineering (Lab.)	0	0	2	1
MCP100	Introduction to Engineering Visualization	0	0	4	2
MCP101	Product Realization through Manufacturing	0	0	4	2
Total Credits					19

Programme-Linked Basic/Engineering Arts/Sciences Core

MLL100	Introduction to Materials Science and Engineering*	3	0	2	4
APL103	Experimental Methods	3	0	2	4
APL105	Mechanics of Solids and Fluids	3	1	0	4
Total Credits					12

* APL102 is superseded by MLL100

Humanities and Social Sciences

Courses from Humanities, Social Sciences and Management offered under this category	15
---	-----------

Departmental Core

TXL130	Polymer Chemistry	3	0	0	3
TXL111	Textile Fibres	2	0	2	3
TXL211	Structure and Physical Properties of Fibres	3	0	0	3
TXL212	Manufactured Fibre Technology	3	0	0	3
TXP212	Manufactured Fibre Technology Lab	0	0	2	1
TXL221	Yarn Manufacture-I	3	0	0	3

TXP221	Yarn Manufacture Laboratory-I	0	0	2	1
TXL222	Yarn Manufacture-II	3	0	0	3
TXP222	Yarn Manufacture Laboratory-II	0	0	2	1
TXL231	Fabric Manufacture-I	3	0	0	3
TXP231	Fabric Manufacture Laboratory-I	0	0	2	1
TXL232	Fabric Manufacture-II	3	0	0	3
TXP232	Fabric Manufacture Laboratory-II	0	0	2	1
TXL241	Technology of Textile Preparation & Finishing	3	0	0	3
TXP241	Technology of Textile Preparation & Finishing Lab	0	0	3	1.5
TXL242	Technology of Textile Coloration	3	0	0	3
TXP242	Technology of Textile Coloration Lab	0	0	3	1.5
TXL361	Evaluation of Textile Materials	3	0	0	3
TXP361	Evaluation of Textiles Lab	0	0	2	1
TXL371	Theory of Textile Structures	3	1	0	4
TXL372	Speciality Yarns and Fabrics	2	0	0	2
TXD401	Major Project Part-I	0	0	8	4
Total Credits					52

Departmental Electives

TXD301	Mini Project	0	0	6	3
TXR301	Professional Practices	0	1	2	2
TXS301	Independent Studies	0	3	0	3
TXL321	Multi and Long Fibre Spinning	3	0	0	3
TXL331	Woven Textile Design	3	0	0	3
TXL381	Costing and its Application in Textiles	3	1	0	4
TXD402	Major Project Part-II	0	0	16	8
TXL700	Modelling and Simulation in Fibrous Assemblies	2	0	2	3
TXL710	High Performance and Specialty Fiber	3	0	0	3
TXL719	Functional & Smart Textiles	3	0	0	3
TXL724	Textured Yarn Technology	3	0	0	3
TXL734	Nonwoven Processes and Products	3	0	0	3
TXL740	Science & App. of Nanotechnology in Textiles	3	0	0	3
TXL741	Environment Management in Textile and Allied Industries	3	0	0	3
TXL750	Science of Clothing Comfort	3	0	0	3
TXL752	Design of Functional Clothing	3	0	0	3
TXL773	Medical Textiles	3	0	0	3
TXL774	Process Control in Yarn & Fabric Manufacturing	3	0	0	3
TXL775	Technical Textiles	3	0	0	3
TXL776	Design & Manuf. of Text. Reinforced Composites	3	0	0	3
TXL777	Product Design and Development	3	0	0	3
TXL781	Project Appraisal and Finance	3	0	0	3
TXL782	Production and Operations Management in Textile Industry	3	0	0	3
TXL783	Design of Experiments and Statistical Techniques	3	0	0	3
TXL786	Technology of Textile Coating and Lamination	2	0	2	3
TXV701	Process Cont. and Econ. in Manmade Fibre Prod.	1	0	0	1
TXV702	Management of Textile Business	1	0	0	1
TXV703	Special Module in Textile Technology	1	0	0	1
TXV704	Special Module in Yarn Manufacture	1	0	0	1
TXV705	Special Module in Fabric Manufacture	1	0	0	1
TXV706	Special Module in Fibre Science	1	0	0	1
TXV707	Special Module in Textile Chemical Processing	1	0	0	1

Semester	Course-1	Course-2	Course-3	Course-4	Course-5	Course-6	Course-7	Course-8	Course-9	Course-10	L	T	P	Credits	Non-Graded Units	Contact Hours	
I	ELL101 Introduction to Electrical Engineering	ELP101 Introduction to Electrical Engineering (Lab.)	MCP100 Introduction to Engineering Visualization	PYL101 Electromagnetism & Quantum Mechanics	MTL100 Calculus	PYP100 Physics Laboratory	MCP101 Product Realization through Manufacturing	NIN100 Introduction to Engineering (Non-graded)	NEIN100 Professional Ethics and Social Responsibility-1 (Non-graded)	NLN100 Language and Writing Skills-1 (Non-Graded)	9	0	3	14	19.0	2.5	31.0
	APL100 Engineering Mechanics	COL100 Introduction to Computer Science	CWL101 Introduction to Chemistry	MTL101 Linear Algebra and Differential Equations	CMP100 Chemistry Laboratory			NEIN101 Professional Ethics and Social Responsibility-2 (Non-graded)	NLN101 Language and Writing Skills-2 (Non-Graded)		9	0	3	14	19.0	2.5	31.0
	3 1 0 4	3 0 2 4	3 1 0 4	3 1 0 4	3 1 0 4	3 0 4 2		0 0 2 1	0 0 2 1	0 0 2 1	0 0 2 1	0	0	3	14	19.0	2.5
II																	
	3 1 0 4	3 0 2 4	3 1 0 4	3 1 0 4	0 0 4 2			0 0 1 0.5	0 0 2 1	0 0 2 1	12	3	6	18.0	1.5	24.0	
<p>Note: Courses 1-6 above are attended in the given order by half of all first year students. The other half of first year students attend the Courses 1-6 of II semester first.</p>																	
III	MLL100 Introduction to Materials Science and Engineering	TXL111 Textile Fibres	TXL130 Polymer Chemistry	APL103 Experimental Methods	CVL100 Environmental Science	HUL2XX											
	3 0 2 4	2 0 2 3	3 0 0 3	3 0 2 4	2 0 0 2	3 1 0 4											
	3 0 2 4	2 0 2 3	3 0 0 3	3 0 2 4	2 0 0 2	3 1 0 4											
IV	TXL211 Structure and Physical Properties of Fibres	TXL231 Fabric Manufacture - I	TXL241 Technology of Textile Preparation & Finishing	SBL100 Introductory Biology for Engineers	TXL221 Yarn Manufacture - I	TXP231 Fabric Manufacture Laboratory - I	TXP221 Yarn Manufacture Laboratory - I	TXP241 Tech. for Tex. Prep. And Finishing Lab	APL105 Mechanics of Solids and Fluids		16	0	6	20.0	0	23.0	
	3 0 0 3	3 0 0 3	3 0 0 3	3 0 2 4	3 0 0 3	3 0 2 1	0 0 2 1	0 0 3 1.5	3 1 0 4		18	0	9	23.5	0	28.0	
	3 0 0 3	3 0 0 3	3 0 0 3	3 0 2 4	3 0 0 3	3 0 2 1	0 0 2 1	0 0 3 1.5	3 1 0 4		18	0	9	23.5	0	28.0	
V	TXL222 Yarn Manufacture - II	TXL232 Fabric Manufacture - II	TXL242 Technology of Textile Coloration	TXL212 Manufactured Fibre Technology	HUL2XX	TXP222 Yarn Manufacture Laboratory - II	TXP232 Fabric Manufacture Laboratory - II	TXP242 Technology of Textile Coloration Lab									
	3 0 0 3	3 0 0 3	3 0 0 3	3 0 0 3	3 1 0 4	0 0 2 1	0 0 2 1	0 0 3 1.5									
	3 0 0 3	3 0 0 3	3 0 0 3	3 0 0 3	3 1 0 4	0 0 2 1	0 0 2 1	0 0 3 1.5									
VI	TXL361 Evaluation of Textile Materials	TXL371 Theory of Textile Structures	TXL372 Speciality Yarns and Fabrics	DE 1 (3)	HUL2XX	TXP212 Manufactured Fibre Technology Lab	TXP361 Evaluation of Textiles Lab										
	3 0 0 3	3 1 0 4	2 0 0 2	3 0 0 3	3 1 0 4	0 0 2 1	0 0 2 1										
	3 0 0 3	3 1 0 4	2 0 0 2	3 0 0 3	3 1 0 4	0 0 2 1	0 0 2 1										
VII	DE 3 (3)	DE 4 (3)	TXD411 B.Tech Project	HUL3XX	DE 2 (3)												
	3 0 0 3	3 0 0 3	0 0 8 4	3 0 0 3	3 0 0 3												
	3 0 0 3	3 0 0 3	0 0 8 4	3 0 0 3	3 0 0 3												
VIII	DE 5 (4)	OC 1 (3)	OC 2 (3)	OC 3 (4)													
	3 0 2 4	3 0 0 3	3 0 0 3	3 0 2 4													
	3 0 2 4	3 0 0 3	3 0 0 3	3 0 2 4													
<p>TOTAL=148.0</p>																	

8. CAPABILITY-LINKED OPTIONS FOR UNDERGRADUATE STUDENTS

As described in Section 4.8, students with CGPA higher than 7.0 and/or earned credits higher than 20 per semester are eligible to register for additional credits towards the following Capability-linked options. They can make use of these additional credits in two blocks of 20 credits to opt for

- (a) Minor/Interdisciplinary Area Specialization
- (b) Departmental Specialization

A student based on his/her performance and interest can choose either one or both. Successful completion of minor area credits and/or Interdisciplinary/Departmental Specialization will be indicated on the degree.

When a student opts for such a specialization and/or a minor area, he/she can use 10 open category (OC) credits (mandatory degree requirement) towards the specialization and/or minor area requirements. For example, a student registered for B.Tech (Chemical Engg.) and opting for minor area in Computer Science, can opt for courses prescribed for the minor area, as part of mandatory 10 credits requirements under OC. He/she will need to do additional 10 credits for completing the Minor area requirements.

A set of pre-defined courses of total 20 credits in a focus area comprises a Departmental Specialization if the courses belong to the parent Department of an undergraduate programme, or a Minor/Interdisciplinary Area Specialization if the courses belong to a different Department/Centre/School. Additional conditions and details are given in this section.

If any course of a Minor/Interdisciplinary area overlaps with any core course (DC or PC category courses) or elective course (DE or PE category courses) of the student's programme, then credits from this course will not count towards the minor area credit requirements, though this course may contribute towards satisfying the requirement of the Minor/Interdisciplinary area. In such a case, the requirement of 20 credits must be completed by taking other courses of the Minor Area or Departmental/Interdisciplinary specialization. A student interested in opting for a Capability-linked option can register for the same online, on a first-come first served basis, after he/she completes at least 2 courses, preferably the core courses (wherever applicable) of the Minor Area/Interdisciplinary/Departmental Specialization being applied for.

Minor Area in Atmospheric Sciences (Centre for Atmospheric Sciences)

Minor Area Core

ASL320	Climate Change: Impacts, Adaptation and Mitigation	3	0	2	4
ASL340	Fundamentals of Weather and Climate	3	0	0	3
ASL350	Introduction to Oceanography	3	0	0	3
ASL360	The Earth's Atmosphere: Physical Principles	3	0	0	3
ASL370	Indian Monsoon, Global Warming and Climate Change	3	0	0	3
ASL380	Climate Modelling	3	0	0	3
Total Credits					6

Minor Area Electives

ASD390	Minor Area Project	0	0	10	5
ASL733	Physics of the Atmosphere	3	0	0	3
ASL734	Dynamics of the Atmosphere	3	0	0	3
ASL735	Atmospheric Chemistry and Air Pollution	3	0	0	3
ASL736	Science of Climate Change	3	0	0	3
ASL737	Physical and Dynamical Oceanography	3	0	0	3
ASL750	Boundary Layer Meteorology	3	0	0	3
ASL751	Dispersion of Air Pollutants	3	0	0	3
ASL752	Mesoscale Meteorology	3	0	0	3
ASL753	Atmospheric Aerosols	3	0	0	3
ASL754	Cloud Physics	3	0	0	3
ASL755	Remote Sensing of the Atmosphere and Ocean	3	0	0	3
ASL756	Synoptic Meteorology	3	0	0	3
ASL757	Tropical Weather and Climate	3	0	0	3
ASL758	General Circulation of the Atmosphere	3	0	0	3
ASL759	Land-Atmosphere Interactions	3	0	0	3
ASL760	Renewable Energy Meteorology	3	0	0	3
ASL761	Earth System Modelling	3	0	0	3
ASL762	Air-Sea Interaction	3	0	0	3
ASL763	Coastal Ocean and Estuarine Processes	3	0	0	3
ASL822	Climate Variability	3	0	0	3
ASL823	Geophysical Fluid Dynamics	3	0	0	3

Minor Area in Biological Sciences (Kusuma School of Biological Sciences)

Minor Area Core

SBL201	High-Dimensional Biology	3	0	0	3
SBP200	Introduction to Practical Modern Biology	0	0	4	2
Total Credits					5

Minor Area Electives

SBD301	Mini Project	0	0	6	3
SBL701	Biometry	3	0	0	3
SBL702	Systems Biology	3	0	0	3
SBL704	Human Virology	3	0	0	3
SBL707	Bacterial Pathogenesis	3	0	0	3
SBL708	Epigenetics in Health and Disease	3	0	0	3
SBL705	Biology of Proteins	3	0	0	3
SBL703	Advanced Cell Biology	3	0	0	3
SBL706	Biologics	3	0	0	3
SBL709	Marine Bioprospecting	3	0	0	3
SBL710	Chemical Biology	3	0	0	3

Minor Area in Business Management (Department of Management Studies)

Minor Area Core (All four courses leading to 12 credits)

MSL301	Organizational & People Management	3	0	0	3
MSL302	Managerial Accounting & Financial Management	3	0	0	3
MSL303	Marketing Management	3	0	0	3
MSL304	Managing Operations	3	0	0	3
Total Credits					12

Minor Area Electives (9 credits required)

MSL704	Science & Technology Policy Systems	3	0	0	3
MSL709	Business Research Methods	1.5	0	0	1.5
MSL710	Creative Problem Solving	3	0	0	3
MSL711	Strategic Management	3	0	0	3
MSL712	Ethics & Values Based Leadership	1.5	0	0	1.5
MSL713	Information Systems Management	3	0	0	3

MSL714	Organizational Dynamics and Environment	3	0	0	3	MSL854	Big Data Analytics & Data Science	1.5	0	0	1.5
MSL715	Quality and Environment Management Systems	3	0	0	3	MSL855	Electronic Commerce	3	0	0	3
MSL716	Fundamentals of Management Systems	3	0	0	3	MSL856	Business Intelligence	3	0	0	3
MSL717	Business Systems Analysis & Design	3	0	0	3	MSL858	Business Process Management with IT	1.5	0	0	1.5
MSL719	Statistics for Management	3	0	0	3	MSL859	Current and Emerging Issues in IT Mgmt.	3	0	0	3
MSL720	Macroeconomic Environment of Business	3	0	0	3	MSL861	Market Research	3	0	0	3
MSL721	Econometrics	3	0	0	3	MSL862	Product Management	3	0	0	3
MSL724	Business Communication	1.5	0	0	1.5	MSL863	Advertising and Sales Promotion Mgmt.	3	0	0	3
MSL725	Business Negotiations	1.5	0	0	1.5	MSL864	Corporate Communication	3	0	0	3
MSL727	Interpersonal Behavior & Team Dynamics	1.5	0	0	1.5	MSL865	Sales Management	3	0	0	3
MSL729	Individual Behavior in Organization	1.5	0	0	1.5	MSL866	International Marketing	3	0	0	3
MSL730	Managing With Power	1.5	0	0	1.5	MSL867	Industrial Marketing Management	3	0	0	3
MSL731	Developing Self Awareness	1.5	0	0	1.5	MSL868	Digital Research Methods	1.5	0	0	1.5
MSL733	Organization Theory	1.5	0	0	1.5	MSL869	Current & Emerging Issues in Marketing	3	0	0	3
MSL734	Management of Small & Medium Scale Industrial Enterprises	3	0	0	3	MSL870	Corporate Governance	1.5	0	0	1.5
MSL740	Quantitative Methods in Management	3	0	0	3	MSL871	Banking and Financial Services	1.5	0	0	1.5
MSL780	Managerial Economics	1.5	0	0	1.5	MSL872	Working Capital Management	3	0	0	3
MSL801	Technology Forecasting & Assessment	3	0	0	3	MSL873	Security Analysis & Portfolio Management	3	0	0	3
MSL802	Management of Intellectual Property Rights	3	0	0	3	MSL874	Indian Financial System	1.5	0	0	1.5
MSL804	Procurement Management	3	0	0	3	MSL875	International Financial Management	3	0	0	3
MSL805	Services Operations Management	3	0	0	3	MSL876	Economics of Digital Business	1.5	0	0	1.5
MSL806	Mergers & Acquisitions	3	0	0	3	MSL877	Electronic Government	1.5	0	0	1.5
MSL807	Selected Topics in Strategic Management	1	0	0	1	MSL878	Electronic Payments	1.5	0	0	1.5
MSL808	Systems Thinking	3	0	0	3	MSL879	Current & Emerging Issues in Finance	3	0	0	3
MSL809	Cyber Security: Managing Risks	3	0	0	3	MSL880	Selected Topics in Management Methodology	3	0	0	3
MSL810	Advanced Data Mining for Business Decisions	1.5	0	0	1.5	MSL881	Management of Public Sector Enterprises in India	3	0	0	3
MSL811	Management Control Systems	3	0	0	3	MSL882	Enterprise Cloud Computing	1.5	0	0	1.5
MSL812	Flexible Systems Management	3	0	0	3	MSL883	ICTs, Development and Business	1.5	0	0	1.5
MSL813	Systems Methodology for Management	3	0	0	3	MSL884	Information System Strategy	3	0	0	3
MSL814	Data Visualization	1.5	0	0	1.5	MSL885	Digital Marketing-Analytics & Optimization	3	0	0	3
MSL815	Decision Support and Expert Systems	3	0	0	3	MSL886	IT Consulting & Practice	3	0	0	3
MSL816	Total Quality Management	3	0	0	3	MSL887	Mobile Commerce	3	0	0	3
MSL817	Systems Waste & Sustainability	3	0	0	3	MSL888	Data Warehousing for Business Decision	1.5	0	0	1.5
MSL818	Industrial Waste Management	3	0	0	3	MSL889	Current & Emerging Issues in Public Sector Management	3	0	0	3
MSL819	Business Process Re-engineering	3	0	0	3	MSL891	Data Analytics using SPSS	1.5	0	0	1.5
MSL820	Global Business Environment	3	0	0	3	MSL892	Predictive Analytics	1.5	0	0	1.5
MSL821	Strategy Execution Excellence	3	0	0	3	MSL893	Public Policy Issues in the Information Age	1.5	0	0	1.5
MSL822	International Business	3	0	0	3	MSL894	Social Media & Business Practices	3	0	0	3
MSL823	Strategic Change & Flexibility	3	0	0	3	MSL895	Advanced Data Analysis for Management	3	0	0	3
MSL824	Policy Dynamics & Learning Organization	3	0	0	3	MSL896	International Economic Policy	3	0	0	3
MSL825	Strategies in Functional Management	3	0	0	3	MSL897	Consultancy Process & Skills	3	0	0	3
MSL826	Business Ethics	3	0	0	3	MSL898	Consultancy Professional Practice	3	0	0	3
MSL827	International Competitiveness	3	0	0	3	MSL899	Current & Emerging Issues in Consultancy Management	3	0	0	3
MSL828	Global Strategic Management	3	0	0	3	MTL732	Financial Mathematics	4	3	1	0
MSL829	Current & Emerging Issues in Strategic Management	3	0	0	3	MSV826	Frontiers in OB & HR Management	1	0	0	1
MSL830	Organizational Structure and Processes	3	0	0	3	MSV827	Frontiers in Finance	1	0	0	1
MSL831	Management of Change	3	0	0	3	MSV828	Frontiers in Information Systems Mgmt.	1	0	0	1
MSL832	Managing Innovation for Organizational Effectiveness	3	0	0	3	MSV832	Frontiers in Strategic Management	1	0	0	1
MSL833	Organizational Development	3	0	0	3	MSV820	Contemporary Issues in IT Management	1	0	0	1
MSL834	Managing Diversity at Workplace	1.5	0	0	1.5	MSV821	Contemporary Issues in Operations Mgmt.	1	0	0	1
MSL835	Labor Legislation and Industrial Relations	3	0	0	3	MSV816	Contemporary Issue in Management	1	0	0	1
MSL836	International Human Resources Management	1.5	0	0	1.5	MSV801	Selected Topics in OB & HR Management	1	0	0	1
MSL839	Current & Emerging Issues in Organizational Management	3	0	0	3	MSV802	Selected Topics in Finance	1	0	0	1
MSL840	Manufacturing Strategy	3	0	0	3	MSV803	Selected Topics in IT Management	1	0	0	1
MSL841	Supply Chain Analytics	3	0	0	3	MSV804	Selected Topics in Operations Management	1	0	0	1
MSL842	Supply Chain Modeling	3	0	0	3	MSV805	Selected Topics in Economics	1	0	0	1
MSL843	Supply Chain Logistics Management	3	0	0	3	MSV806	Selected Topics in Marketing Management	1	0	0	1
MSL844	Systems Reliability, Safety and Maintenance Management	3	0	0	3	MSL837	Entrepreneurial Finance	3	0	0	3
MSL845	Total Project Systems Management	3	0	0	3	MSL750	Behavioral Finance	1.5	0	0	1.5
MSL846	Total Productivity Management	3	0	0	3	MSL751	Financial Technology	1.5	0	0	1.5
MSL847	Advanced Methods for Management Research	3	0	0	3	MSL860	Derivatives	3	0	0	3
MSL848	Applied Operations Research	3	0	0	3	MSL838	Fixed Income Securities	3	0	0	3
MSL849	Current & Emerging Issues in Manufacturing Management	3	0	0	3	MSL890	Financial Engineering	3	0	0	3
MSL850	Management of Information Technology	3	0	0	3	MSL310	Financial Institutions and Markets	3	0	0	3
MSL851	Strategic Alliance	1.5	0	0	1.5	MSL718	Management of Blockchain Technology	1.5	0	0	1.5
MSL852	Network System: Applications and Management	3	0	0	3	MSL782	Business Cycles and Global Economy	1.5	0	0	1.5
MSL853	Software Project Management	3	0	0	3	MSL783	Global Economic Development	1.5	0	0	1.5
						MSL784	Sovereign Debt and Default	3	0	0	3

Minor Area in Entrepreneurship (Department of Management Studies)

Minor Area Core : 5 Courses (Total of 12 Credits)

MSL305	New Venture Creation	2	0	2	3
MSL306	Ideation and Prototyping	2	0	2	3
MSL307	Venture Financing & Teaming	2	0	2	3
MSD308	Product Viability & Market Traction	0	0	3	1.5
MSD309	Business Plan & Funding	0	0	3	1.5

Minor Area Electives : 3 Courses (Total of 9 Credits) from the following lists

MSL301	Organization & People Management	3	0	0	3
MSL302	Managerial Accounting & Financial Management	3	0	0	3
MSL303	Marketing Management	3	0	0	3
MSL304	Managing Operations	3	0	0	3
MSL401	Entrepreneurial Design Thinking	3	0	0	3
MSL402	Social Innovation & Entrepreneurship	3	0	0	3
MSL403	Entrepreneurial Market Strategies	3	0	0	3
MSL404	Entrepreneurial Business Development	3	0	0	3
MSL405	Financial Accounting & Compliance for Startups	3	0	0	3
MSL406	Company Law, Governance, IPR & Legal Issues for Startups	3	0	0	3
MSL407	Corporate Innovation & Entrepreneurship	3	0	0	3
MSL408	Startup Performance Management	3	0	0	3
MSL409	Entrepreneurship and Life Balance	3	0	0	3
MSL706	Business Law	3	0	0	3
MSL720	Macroeconomic Environment of Business	3	0	0	3
MSL721	Econometrics	3	0	0	3
MSL734	Management of Small & Medium Scale Industrial Enterprises	3	0	0	3

Minor Area in Economics (Department of Humanities and Social Sciences)

Minor Area Core (Minimum of 8 credits)

HUL211	Introduction to Economics	3	1	0	4
HUL212	Microeconomics	3	1	0	4
HUL213	Macroeconomics	3	1	0	4
HUL217	History of Economic Thought	3	1	0	4

Minor Area Electives

HUL286	Social Science Approaches to Development	3	1	0	4
HUL311	Applied Game Theory	3	0	0	3
HUL312	Distribution and Growth	3	0	0	3
HUL314	International Economics	3	0	0	3
HUL315	Econometric Methods	3	0	0	3
HUL316	Indian Economic Problems and Policies	3	0	0	3
HUL318	Public Finance and Public Economics	3	0	0	3
HUL319	Comparative Development Paths: Asia and the world	3	0	0	3
HUL320	Selected Topics in Economics	3	0	0	3
HUL372	Agrarian India: Past and Present	3	0	0	3
HSD700	Minor Project	0	0	6	3
HSL711	Macro Development Economics	3	0	0	3
HSL712	Microeconomics	3	0	0	3
HSL713	Macroeconomics	3	0	0	3
HSL714	International Economics	3	0	0	3
HUL715	Time Series Econometrics and Forecasting	3	0	0	3
HSL716	Industrial Economics	3	0	0	3
HSL717	Perspectives on Indian Economy	3	0	0	3
HUL718	Political Economy of Development	3	0	0	3
HSL719	Advanced Econometrics	3	0	0	3
HSL720	Development Economics	3	0	0	3
HUL731	Perspectives on Development	3	0	0	3
HUL735	Research Methods in Economics	1	0	2	2
HUL736	Planning and Economic Development	3	0	0	3
HUL737	Advanced Growth Theory	3	0	0	3
HUL738	International Economics	2	1	0	3
HUL755	Fascism: Philosophical Perspectives	3	0	0	3
HUL756	Time Series Econometrics and Forecasting	3	0	0	3
HUL762	Industrial Economics	3	0	0	3

HSL811	Advanced Economic Growth Theory	3	0	0	3
HSL813	Foundations of Decision Theory	3	0	0	3
HSL814	Research Methods in Economics	1	0	2	2
HSL815	Theory of Market Design	3	0	0	3
HSL816	Game Theory	3	0	0	3
HSL817	Health Economics	3	0	0	3
HSL818	Labor Economics	3	0	0	3
HSL820	Advanced Topics in Economics	3	0	0	3

Minor Area in Computational Mechanics (Department of Applied Mechanics)

Minor Area Core

APL300	Computational Mechanics	3	0	2	4
APL705	Finite Element Method	3	0	2	4

Minor Area Electives

APD311	Project	0	0	8	4
APL300	Computational Mechanics	3	0	2	4
APL310	Constitutive Modelling	3	0	2	4
APL340	Chaos	3	0	2	4
APL360	Engineering Fluid Flows	3	1	0	4
APL380	Biomechanics	3	0	0	3
APL410	Computational Fluid Dynamics	3	0	2	4
APL440	Parallel Processing in Computational Mechanics	3	0	2	4
APL705	Finite Element Method	3	0	2	4
APL710	Computer Aided Design	3	0	2	4
APL736	Multiscale Modelling of Crystalline Materials	3	0	2	4

Minor Area in Design (Department of Design)

Minor Area Core (10 credits)

DSP721	Design and Innovation Methods	1	0	4	3
DSL751	Form and Aesthetics	2	0	2	3
DSD799	Design Project	1	0	6	4

Total Credits

10

Minor Area Electives (Minimum of 10 credits)

DSL782	Design for Usability	2	0	2	3
DSR832	Design for User Experience	3	0	0	3
DSR862	Design in Indian Context	3	0	0	3
DSR852	Strategic Design Management	2	0	2	3
DSR822	Design for Sustainability	2	0	2	3
DSR772	Transportation Design	2	0	2	3
DSL810	Special Topics in Design I	3	0	0	3
DSL820	Special Topics in Design II	3	0	0	3
DSV820	Special Modules in Design	1	0	0	1
DSP722	Applied Ergonomics	1	0	2	2
DSP712	Exhibitions and Environmental Design	2	0	2	3
DSR812	Media Studies	2	0	2	3
DSR762	Vehicle Design	2	0	2	3
COP315	Embedded System Design Project	1	0	6	4
MCL749	Mechatronics Product Design	3	0	2	4
MCL750	Product Design and Manufacturing	1	0	4	3
TXL777	Product Design and Development	3	0	0	3
APL710	Computer Aided Design	3	0	2	4
APL190	Design Engineering	3	0	2	4
HUL704	Inclusive Innovation	3	0	2	4
BML741	Medical Device Design	2	0	2	4
BMD742	Minor Biodesign Project	0	0	8	4
APL775	Design Methods	3	0	0	3
MCL744	Design for Manufacture and Assembly	3	0	2	4

Minor Area Non Departmental Electives in Material Science

Minor Area Electives

MCL336	Advances in Welding	3	0	2	4
MCL769	Metal Forming Analysis	3	0	2	4
MCL780	Casting Technology	3	0	2	4
MCL787	Welding Science and Technology	3	0	2	4
MCL791	Processing and Mechanics of Composites	3	0	2	4
PTL702	Polymer Science and Technology	3	0	0	3

Minor Area in Computer Science (Department of Computer Science and Engineering)

Note : A student needs to do a minimum of three courses out of Minor Area Core and remaining courses from Minor Area Electives.

Minor Area Core

COL106	Data Structures and Algorithms	3	0	4	5
COL202	Discrete Mathematical Structures	3	1	0	4
COL215	Digital Logic and System Design	3	0	4	5
COL216	Computer Architecture	3	0	2	4
COL226	Programming Languages	3	0	4	5
COP290	Design Practices	0	0	6	3
COL331	Operating Systems	3	0	4	5
COL333	Principles of Artificial Intelligence*	3	0	2	4
COL334	Computer Networks	3	0	2	4
COL351	Analysis and Design of Algorithms	3	1	0	4
COL352	Introduction to Automata and Theory of Computation	3	0	0	3
COL362	Introduction to Database Mgmt Systems*	3	0	2	4
COL380	Introduction to Parallel and Distributed Programming	2	0	2	3

Total Credits (any three above courses) 12-15

Minor Area Electives

COD300	Design Project (Non-Graded)	0	0	4	2
COD310	Mini Project	0	0	6	3
COP315	Embedded System Design Project	0	1	6	4
COL341	Machine Learning	3	0	2	4
COL718	Architecture of High Performance Computers	3	0	2	4
COL719	Synthesis of Digital Systems	3	0	2	4
COL722	Introduction to Compressed Sensing	3	0	0	3
COL724	Advanced Computer Networks	3	0	2	4
COL726	Numerical Algorithms	3	0	2	4
COL728	Compiler Design	3	0	3	4.5
COL729	Compiler Optimization	3	0	3	4.5
COL730	Parallel Programming	3	0	2	4
COL732	Virtualization and Cloud Computing	3	0	2	4
COL733	Cloud Computing Technology Fundamentals	3	0	2	4
COL740	Software Engineering	3	0	2	4
COL750	Foundations of Automatic Verification	3	0	2	4
COL751	Algorithmic Graph Theory	3	0	0	3
COL752	Geometric Algorithms	3	0	2	4
COL753	Complexity Theory	3	0	0	3
COL754	Approximation Algorithms	3	0	0	3
COL756	Mathematical Programming	3	0	0	3
COL757	Model Centric Algorithm Design	3	0	2	4
COL758	Advanced Algorithms	3	0	2	4
COL759	Cryptography & Computer Security	3	0	0	3
COL760	Advanced Data Management	3	0	2	4
COL761	Data Mining	3	0	2	4
COL762	Database Implementation	3	0	2	4
COL764	Information Retrieval and Web Search	3	0	2	4
COL765	Introduction to Logic and Functional Programming	3	0	2	4
COL768	Wireless Networks	3	0	2	4
COL770	Advanced Artificial Intelligence	3	0	2	4
COL772	Natural Language Processing	3	0	2	4
COL774	Machine Learning	3	0	2	4
COL776	Learning Probabilistic Graphical Models	3	0	2	4
COL780	Computer Vision	3	0	2	4
COL781	Computer Graphics	3	0	3	4.5
COL783	Digital Image Analysis	3	0	3	4.5
COL786	Advanced Functional Brain Imaging	3	0	2	4
COL788	Advanced Topics in Embedded Computing	3	0	0	3
COL812	System Level Design and Modelling	3	0	0	3
COL818	Principles of Multiprocessor Systems	3	0	2	4
COL819	Advanced Distributed Systems	3	0	2	4
COP820	Processor Design Laboratory	0	0	8	4
COL821	Reconfigurable Computing	3	0	0	3
COL829	Advanced Computer Graphics	3	0	2	4
COL830	Distributed Computing	3	0	0	3
COL831	Semantics of Programming Languages	3	0	0	3
COL832	Proofs and Types	3	0	0	3

COL851	Special Topics in Operating Systems	3	0	0	3
COL852	Special Topics in Compilers	3	0	0	3
COL860	Special Topics in Parallel Computation	3	0	0	3
COL861	Special Topics in Hardware Systems	3	0	0	3
COL862	Special Topics in Software Systems	3	0	0	3
COL863	Special Topics in Theoretical Computer Science	3	0	0	3
COL864	Special Topics in Artificial Intelligence	3	0	0	3
COL865	Special Topics in Computer Applications	3	0	0	3
COL866	Special Topics in Algorithms	3	0	0	3
COL867	Special Topics in High Speed Networks	3	0	0	3
COL868	Special Topics in Database Systems	3	0	0	3
COL869	Special Topics in Concurrency	3	0	0	3
COL870	Special Topics in Machine Learning	3	0	0	3
COL871	Special Topics in Programming Languages	3	0	0	3
COL872	Special Topics in Cryptography	3	0	0	3
COL873	Special Topics in Natural Language Processing	3	0	0	3
COL874	Special Topics in Compilers and Language Implementation	3	0	0	3
COL876	Special Topics in Formal Methods	3	0	0	3
COL886	Special Topics in Operating Systems	3	0	0	3
COD891	Minor Project	0	0	6	3
COD892	M.Tech. Project Part-I	0	0	14	7
COD893	M.Tech. Project Part- II	0	0	28	14
COR310	Professional Practices (CS)	1	0	2	2
COS310	Independent Study (CS)	0	3	0	3
COV877	Special Module on Visual Computing	1	0	0	1
COV878	Special Module in Machine Learning	1	0	0	1
COV879	Special Module in Financial Algorithms	2	0	0	2
COV880	Special Module in Parallel Computation	1	0	0	1
COV881	Special Module in Hardware Systems	1	0	0	1
COV882	Special Module in Software Systems	1	0	0	1
COV883	Special Module in Theoretical Computer Science	1	0	0	1
COV884	Special Module in Artificial Intelligence	1	0	0	1
COV885	Special Module in Computer Applications	1	0	0	1
COV886	Special Module in Algorithms	1	0	0	1
COV887	Special Module in High Speed Networks	1	0	0	1
COV888	Special Module in Database Systems	1	0	0	1
COV889	Special Module in Concurrency	1	0	0	1

Minor Area in Cogeneration and Energy Efficiency (Department of Energy Science and Engineering)

Minor Area Core

ESL748	Economics of Energy Conservation	3	0	0	3
ESL784	Cogeneration and Energy Efficiency	3	0	0	3
ESL785	Energy Analysis	3	0	0	3
Total Credits 9					

Minor Area Electives

ESL714	Power Plant Engineering	3	0	0	3
ESL718	Power Generation, Transmission and Distribution	3	0	0	3
ESL722	Integrated Energy Systems	3	0	0	3
ESL726	Waste Heat Recovery	3	0	0	3
ESL776	Industrial Energy and Environmental Analysis	3	0	0	3
ESL875	Alternative Fuels for Transportation	3	0	0	3
ESL786	Exergy Analysis	3	0	0	3

Minor Area in Renewable Energy (Department of Energy Science and Engineering)

Minor Area Electives

ESP713	Energy Laboratories	0	0	6	3
ESL731	Biomass - A Renewable Resource	3	0	0	3
ESL732	Bioconversion and Processing of Waste	3	0	0	3
ESL742	Economics and Financing of Renewable Energy Systems	3	0	0	3
ESL755	Solar Photovoltaic Devices and Systems	3	0	0	3
ESL768	Wind Energy and Hydro Power Systems	3	0	0	3
ESL770	Solar Energy Utilization	3	0	0	3

ESL840	Solar Architecture	3	0	0	3
ESL875	Alternative Fuels for Transportation	3	0	0	3
ESL880	Solar Thermal Power Generation	3	0	0	3

Minor Area in Technologies for Sustainable Rural Development (Centre for Rural Development and Technology)

Minor Area Core (Any three of the following courses)

RDL700	Biomass Production	3	0	0	3
RDL705	Rural Resources and Livelihoods	3	0	0	3
RDL722	Rural Energy Systems	3	0	0	3
RDL724	Technologies for Water and Waste Mgmt.	2	0	2	3
RDL730	Technology Alternatives for Rural Development	3	0	0	3
RDL760	Food Quality and Safety	3	0	0	3

Total Credits 9

Minor Area Electives

RDL701	Rural Industrialization Policies, Programmes and Cases	3	0	0	3
RDL710	Rural India and Planning for Development	3	0	0	3
RDL726	Herbal, Medicinal and Aromatic Plants	3	0	0	3
RDL740	Technology for Utilization of Wastelands and Weeds	3	0	0	3
RDL801	Successful Forms of Grassroot Organizations	3	0	0	3
RDL807	Women, Technology and Development	2	0	2	3
RDD750	Minor Project	0	0	6	3
RDP750	Biomass Lab	0	0	6	3
RDL702	Karigar & Traditional Industries	3	0	2	4
RDL725	Ecological Perspective of Growth & Development	3	0	0	3
RDL727	Conservation and Recycling Practice in Rural Area	3	0	2	4
RDL761	Value Chain in Agro-Food Processing	2	0	2	3
RDL770	Rural Value Chain and Technologies for Holistic Development	2	0	2	3

Minor Area / Departmental Specialization in Biopharmaceuticals and Fine Chemicals (Department of Chemical Engineering)

Minor Area/Specialization Core

CLD415	Major Project in Biopharmaceuticals and Fine Chemicals	0	0	10	5
--------	--	---	---	----	---

Total Credits 5

Minor Area/Specialization Electives

CLL296	Nano-engineering of Soft Materials	3	0	0	3
CLL730	Structure, Transport and Reactions in BioNano Systems	3	0	0	3
CLL742	Experimental Characterization of BioMacromolecules	3	0	0	3
CLL767	Structures and Properties of Polymers	3	0	0	3
CLL775	Polymerization Process Modeling	3	0	0	3
CLL778	Interfacial Behaviour and Transport of Biomolecules	3	0	0	3
CLL779	Molecular Biotechnology and in-vitro Diagnostics	3	0	0	3
CLL780	Bioprocessing and Bioseparations	3	0	0	3
CLL781	Process Operations Scheduling	3	0	0	3
CLL786	Fine Chemicals Technology	3	0	0	3
CLL791	Chemical Product and Process Integration	3	0	0	3
CLL792	Chemical Product Development and Commercialization	3	0	0	3
CLL793	Membrane Science and Engineering	3	0	0	3
SBL705	Biology of Proteins	3	0	0	3

Minor Area/Departmental Specialization in Complex Fluids and Materials (Department of Chemical Engineering)

Minor Area/Specialization Core

CLD413	Major Project in Complex Fluids	0	0	10	5
--------	---------------------------------	---	---	----	---

Total Credits 5

Minor Area/Specialization Electives

CLL296	Nano-engineering of Soft Materials	3	0	0	3
CLL766	Interfacial Engineering	3	0	0	3
CLL767	Structures and Properties of Polymers	3	0	0	3
CLL771	Introduction to Complex Fluids	3	0	0	3
CLL772	Transport Phenomena in Complex Fluids	3	0	0	3
CLL773	Thermodynamics of Complex Fluids	3	0	0	3
CLL774	Simulation Techniques for Complex Fluids	3	0	0	3
CLL775	Polymerization Process Modeling	3	0	0	3
CLL776	Granular Materials	3	0	0	3
CLL777	Complex Fluids Technology	3	0	0	3

Minor Area / Departmental Specialization in Energy and Environment (Department of Chemical Engineering)

Minor Area/Specialization Core

CLD412	Major Project in Energy and Environment	0	0	10	5
--------	---	---	---	----	---

Total Credits 5

Minor Area/Specialization Electives

CLL705	Petroleum Reservoir Engineering	3	0	0	3
CLL706	Petroleum Production Engineering	3	0	0	3
CLL720	Principles of Electrochemical Engineering	3	0	0	3
CLL721	Electrochemical Methods	3	0	0	3
CLL722	Electrochemical Conversion and Storage Devices	3	0	0	3
CLL723	Hydrogen Energy and Fuel Cell Technology	3	0	0	3
CLL724	Environmental Engineering and Waste Management	3	0	0	3
CLL725	Air Pollution Control Engineering	3	0	0	3
CLL726	Molecular Modeling of Catalytic Reactions	3	0	0	3
CLL727	Heterogeneous Catalysis and Catalytic Reactors	3	0	0	3
CLL728	Biomass Conversion and Utilization	3	0	0	3
CLL729	Colloids and Aerosols	3	0	0	3
CLL733	Industrial Multiphase Reactors	3	0	0	3
CLL734	Process Intensification and Novel Reactors	3	0	0	3
CLL735	Design of Multicomponent Separation Processes	3	0	0	3
CLL736	Experimental Characterization of Multiphase Reactors	3	0	0	3
CLL743	Petrochemicals Technology	3	0	0	3
CLL768	Fundamentals of Computational Fluid Dynamics	2	0	2	3
CLL769	Applications of Computational Fluid Dynamics	2	0	2	3
CLL793	Membrane Science and Engineering	3	0	0	3
CLL794	Petroleum Refinery Engineering	3	0	0	3

Minor Area / Departmental Specialization in Process Engineering, Modelling and Optimization (Department of Chemical Engineering)

Minor Area/Specialization Core

CLD414	Major Project in Process Engineering, Modeling and Optimization	0	0	10	5
--------	---	---	---	----	---

Total Credits 5

Minor Area/Specialization Electives

CLL390	Process Utilities and Pipeline Design	3	0	0	3
CLL475	Safety and Hazards in Process Industries	3	0	0	3
CLL477	Materials of Construction	3	0	0	3
CLL707	Population Balance Modeling	3	0	0	3
CLL733	Industrial Multiphase Reactors	3	0	0	3
CLL734	Process Intensification and Novel Reactors	3	0	0	3
CLL735	Design of Multicomponent Separation Processes	3	0	0	3
CLL736	Experimental Characterization of Multiphase Reactors	3	0	0	3
CLL760	Crystal Engineering and Design	3	0	0	3
CLL761	Chemical Engineering Mathematics	3	0	0	3
CLL762	Advanced Computational Techniques in Chemical Engineering	2	0	2	3
CLL768	Fundamentals of Computational Fluid Dynamics	2	0	2	3

CLL769	Applications of Computational Fluid Dynamics	2	0	2	3
CLL781	Process Operations Scheduling	3	0	0	3
CLL782	Process Optimization	3	0	0	3
CLL783	Advanced Process Control	3	0	0	3
CLL784	Process Modeling and Simulation	3	0	0	3
CLL785	Evolutionary Optimization	3	0	0	3
CLL787	Statistical Methods for Chemical Engg.	3	0	0	3
CLL788	Process Data Analytics	3	0	0	3
CLL789	Applied Time Series Analysis for Chemical Engineering	3	0	0	3
CLL791	Chemical Product and Process Integration	3	0	0	3
CLL792	Chemical Product Development and Commercialization	3	0	0	3
CLL793	Membrane Science and Engineering	3	0	0	3

Minor Area/Departmental Specialization in Nanoscience and Technology (Department of Physics)

Minor Area/Specialization Core

PYL122	Quantum Mechanics	3	1	0	4
PYL201	Fundamentals of Dielectrics & Semiconductors	3	1	0	4
Total Credits		8			

Minor Area/Specialization Electives

PYL321	Low Dimensional Physics	3	0	0	3
PYL322	Nanoscale Fabrication	3	0	0	3
PYL323	Nanoscale Microscopy	2	0	0	2
PYL324	Spectroscopy of Nanomaterials	2	0	0	2
PYL421	Functional Nanostructures	3	0	0	3
PYL422	Spintronics	3	0	0	3
PYL423	Nanoscale Energy Materials & Devices	3	0	0	3
PYV428	Selected Topics in Nanotechnology	2	0	0	2
PYV429	Special Topics in Nanotechnology	1	0	0	1
PYD414	Project III	0	0	8	4

Minor Area/Departmental Specialization in Photonics Technology (Department of Physics)

Minor Area/Specialization Core

PYL122	Quantum Mechanics	3	1	0	4
PYL115	Applied Optics	3	1	0	4
Total Credits		8			

Minor Area/Specialization Electives

PYL311	Lasers	3	0	0	3
PYL312	Semiconductor Optoelectronics	3	0	0	3
PYL313	Fourier Optics and Holography	3	0	0	3
PYL411	Quantum Electronics	3	0	0	3
PYL412	Ultrafast Laser Systems and Applications	3	0	0	3
PYL413	Fiber and Integrated Optics	3	0	0	3
PYD414	Project III	0	0	8	4
PYL414	Engineering Optics	3	0	0	3
PYV418	Selected Topics in Photonics	2	0	0	2
PYV419	Special Topics in Photonics	1	0	0	1

Minor Area/Departmental Specialization in Quantum Technologies (Department of Physics)

Minor Area/Specialization Core

PYL122	Quantum Mechanics	3	1	0	4
PYL125	Solid State Physics -I OR	3	1	0	4
PYL209	Optics and Photonics -II	3	0	0	3
Total Credits		7/8			

Minor Area/Specialization Electives

PYL331	Applied Quantum Mechanics	3	0	0	3
PYL321	Low Dimensional Physics	3	0	0	3
PYL703	Electronic Properties of Materials	3	0	0	3
PYL728	Quantum Heterostructures	2	0	0	2
PYL422	Spintronics	3	0	0	3
PYL740	Advanced Condensed Matter Theory	3	0	0	3
PYV4XX	Selected Topics in Quantum Materials and devices	2	0	0	2

PYV4XX	Special Topics in Quantum Mechanics with Applications to Nanotechnology and Information Science	1	0	0	1
PYL411	Quantum Electronics	3	0	0	3
PYL414	Engineering Optics	3	0	0	3
PYL748	Quantum Optics	3	0	0	3
PYL749	Quantum information and Computation	3	0	0	3
PYL793	Photonic Devices	3	0	0	3
PYL757	Statistical and Quantum Optics	3	0	0	3
PYL758	Advanced Quantum optics and applications	3	0	0	3
PYL762	Statistical Optics and Optical Coherence Theory	3	0	0	3
PYV4XX	Selected Topics in Cold Atoms and Quantum Technologies	2	0	0	2
PYD414	Project-III	0	0	8	4

Minor Area / Departmental Specialization in Theoretical and Computational Techniques in Physics (Department of Physics)

Minor Area/Specialization Core

PYL122	Quantum Mechanics	3	1	0	4
PYL204	Computational Physics	3	1	0	4
Total Credits		8			

Minor Area/Specialization Electives

PYL332	General Theory of Relativity & Cosmology	3	0	0	3
PYD414	Project III	0	0	8	4
PYL432	Quantum Electrodynamics	3	0	0	3
PYL433	Gauge Field Theory	3	0	0	3
PYV435	Monte Carlo and Molecular Dynamics Simulation	2	1	0	3
PYL745	Advanced Statistical Mechanics	3	0	0	3
PYL749	Quantum Information and Computing	3	0	0	3
PYL739	Computational Techniques for Solid State Materials	3	0	0	3
PYL743	Group Theory	3	0	0	3
PYV431	Relativistic Quantum Mechanics	2	0	0	2
PYV438	Selected Topics in Theoretical and Computational Physics	2	0	0	2
PYV439	Special Topics in Theoretical and Computational Physics	1	0	0	1

Interdisciplinary Specialization in Biodesign Specialization Core

BML741	Medical Device Design	2	0	4	4
BMD742	Minor Biodesign Project	0	0	8	4
Total Credits		8			

Specialization Electives

APL380	Biomechanics	3	0	0	3
BML700	Intro. to Basic Medical Sciences for Engineers	3	0	0	3
BML710	Industrial Biomaterial Technology	3	0	0	3
BML720	Medical Imaging	3	0	0	3
BML735	Biomedical Signal and Image processing	2	0	2	3
BML737	Application of Mathematics in Biomedical Engineering	2	0	0	2
BML743	Special Topics in Biodesign	3	0	0	3
BML750	Point of Care Medical Diagnostic Devices	3	0	0	3
BML770	Fundamentals of Biomechanics	3	0	0	3
BML771	Orthopaedic Device Design	2	0	0	2
BML772	Biofabrication	3	0	0	3
BML810	Tissue Engineering	3	0	0	3
BML820	Biomaterials	3	0	0	3
BML830	Biosensor Technology	3	0	2	4
CLL779	Molecular Biotechnology and in-vitro Diagnostics	3	0	0	3
MCL442	Thermofluid Analysis of Biosystems	3	0	0	3
TXL773	Medical Textiles	3	0	0	3

Interdisciplinary Specialization in Robotics Specialization Core

Core 1

MCL111+	Kinematics and Dynamics of Machines	3	0	2	4
MCL212#	Control Theory and Applications	3	0	2	4

ELL225*	Control Engineering-I	3	1	0	4
COP315*	Embedded System Design Project	0	1	6	4
ELL365*	Embedded Systems	3	0	0	3

*Students of ME1/ME2 to take only one of these courses as core.
 #Students of CS1/CS5 to take only one of these courses as core.
 +Core for EE1/EE3 students only.

Other Students can select any one of the Core 1 courses mentioned above.

Core 2

JRL301	Robotics Technology	3	0	0	3
--------	---------------------	---	---	---	---

Core 3

JRD301	Mini Project in Robotics	0	0	14	7
--------	--------------------------	---	---	----	---

Total Credits 13/14

Since the course may have Pre-requisite(s), plan in advance.
 A student is required to complete (one of the core 1 course), (core 2 course) and (core 3 course).

Specialization Electives

COL106	Data Structures	3	0	2	4
COL333	Principles of Artificial Intelligence	3	0	2	4
COL341	Machine Learning	3	0	2	4
COL351	Analysis and Design of Algorithms	3	1	0	4
COL671	Artificial Intelligence	3	0	2	4
COL740	Software Engineering	3	0	2	4
COL752	Geometric Algorithms	3	0	0	3
COL774	Machine Learning	3	0	2	4
COL770	Advanced Artificial Intelligence	3	0	2	4
COL780	Computer Vision	3	0	2	4
COL783	Digital Image Analysis	3	0	3	4.5
COL864	Special Topics in Artificial Intelligence	3	0	0	3
COL870	Special Topics in Machine Learning	3	0	0	3
ELL406	Robotics and Automation	3	0	0	3
ELL409	Machine Intelligence and Learning	3	0	2	4
ELL703	Optimal Control Theory	3	0	0	3
ELL715	Digital Image Processing	3	0	2	4
ELL767	Mechatronics	3	0	0	3
ELL787	Embedded Systems and Applications	3	0	0	3
ELL791	Neural Systems and Learning Machines	3	0	2	4
ELL793	Computer Vision	3	0	0	3
ELL798	Agent Technology	3	0	0	3
MTL342	Analysis and Design of Algorithms	3	1	0	4
MTL509	Numerical Analysis	3	1	0	4
MTL729	Computational Algebra and its Applications	3	0	0	3
MTL744	Mathematical Theory of Coding	3	0	0	3
MTL811	Mathematical Foundation of Artificial Intelligence	3	0	0	3
MTL851	Applied Numerical Analysis	3	0	0	3
MCL731	Analytical Dynamics	3	0	0	3
MCL738	Dynamics of Multibody Systems	2	0	2	3
MCL745	Robotics	3	0	2	4
MCL749	Mechatronics Product Design	3	0	2	4
MCL837	Advanced Mechanisms	2	0	2	3
MCL845	Advanced Robotics	2	0	2	3

Departmental Specialization in Applications and Information Technology (Department of Computer Science and Engineering)

Specialization Core

COD494	B.Tech. Project Part-II	0	0	16	8
COL703	Logic for Computer Science	3	0	2	4
Total Credits		12			

Specialization Electives

COL333	Principles of Artificial Intelligence*	3	0	2	4
COL362	Introduction to Database Mgmt. Systems*	3	0	2	4
COL722	Introduction to Compressed Sensing	3	0	0	3
COL757	Model Centric Algorithm Design	3	0	2	4
COL760	Advanced Data Management	3	0	2	4
COL761	Data Mining	3	0	2	4
COL762	Database Implementation	3	0	2	4

COL764	Information Retrieval and Web Search	3	0	2	4
COL765	Introduction to Logic and Functional Programming	3	0	2	4
COL770	Advanced Artificial Intelligence	3	0	2	4
COL786	Advanced Functional Brain Imaging	3	0	2	4
COL865	Special Topics in Computer Applications	3	0	0	3
COL869	Special Topics in Concurrency	3	0	0	3
COV885	Special Module in Computer Applications	1	0	0	1
COV888	Special Module in Database Systems	1	0	0	1
COV889	Special Module in Concurrency	1	0	0	1
SIL769	Internet Traffic-Measurement, Modeling & Analysis	3	0	2	4
SIL801	Special Topics in Multimedia System	3	0	0	3
SIL802	Special Topics in Web Based Computing	3	0	0	3
SIV813	Applications of Computer in Medicines	1	0	0	1
SIV861	Information and Comm Technologies for Development	1	0	0	1
SIV864	Special Module on Media Processing & Communication	1	0	0	1
SIV871	Special Module in Computational Neuroscience	1	0	0	1
SIV889	Special Module in Human Computer Interaction	1	0	0	1
SIV895	Special Module on Intelligent Information Processing	1	0	0	1

Departmental Specialization in Architecture and Embedded Systems (Department of Computer Science and Engineering)

Specialization Core

COD494	B.Tech. Project Part-II	0	0	16	8
COL703	Logic for Computer Science	3	0	2	4
Total Credits		12			

Specialization Electives

COP315	Embedded System Design Project	0	1	6	4
COL718	Architecture of High Performance Computers	3	0	2	4
COL719	Synthesis of Digital Systems	3	0	2	4
COL788	Advanced Topics in Embedded Computing	3	0	0	3
COL812	System Level Design and Modelling	3	0	0	3
COL818	Principles of Multiprocessor Systems	3	0	2	4
COP820	Processor Design Laboratory	0	0	8	4
COL821	Reconfigurable Computing	3	0	0	3
COL861	Special Topics in Hardware Systems	3	0	0	3
COV881	Special Module in Hardware Systems	1	0	0	1

Departmental Specialization in Data Analytics and Artificial Intelligence (Department of Computer Science and Engineering)

Specialization Core

COD494	B.Tech. Project Part 2	0	0	16	8
COL703	Logic for Computer Science	3	0	2	4
Total Credits		12			

Specialization Electives

COL333	Principles of Artificial Intelligence*	3	0	2	4
COL341	Machine Learning	3	0	2	4
COL362	Introduction to Database Mgmt. Systems*	3	0	2	4
COL760	Advanced Data Management	3	0	2	4
COL761	Data Mining	3	0	2	4
COL762	Database Implementation	3	0	2	4
COL764	Information Retrieval and Web Search	3	0	2	4
COL765	Introduction to Logic and Functional Programming	3	0	2	4
COL770	Advanced Artificial Intelligence	3	0	2	4
COL772	Natural Language Processing	3	0	2	4
COL774	Machine Learning	3	0	2	4
COL776	Learning Probabilistic Graphical Models	3	0	2	4
COL786	Advanced Functional Brain Imaging	3	0	2	4
COL864	Special Topics in Artificial Intelligence	3	0	0	3
COL868	Special Topics in Database Systems	3	0	0	3

COL869	Special Topics in Concurrency	3	0	0	3
COL870	Special Topics in Machine Learning	3	0	0	3
COL873	Special Topics in Natural Language Processing	3	0	0	3
COV878	Special Module in Machine Learning	1	0	0	1
COV884	Special Module in Artificial Intelligence	1	0	0	1
COV888	Special Module in Database Systems	1	0	0	1
COV889	Special Module in Concurrency	1	0	0	1

Departmental Specialization in Graphics and Vision (Department of Computer Science and Engineering)

Specialization Core

COD494	B.Tech. Project Part 2	0	0	168	
COL703	Logic for Computer Science	3	0	2	4

Total Credits 12

Specialization Electives

COL780	Computer Vision	3	0	2	4
COL781	Computer Graphics	3	0	3	4.5
COL783	Digital Image Analysis	3	0	3	4.5
COL829	Advanced Computer Graphics	3	0	2	4
COV877	Special Module on Visual Computing	1	0	0	1
SIL801	Special Topics in Multimedia System	3	0	0	3

Departmental Specialization in Software Systems (Department of Computer Science and Engineering)

Specialization Core

COD494	B.Tech. Project Part 2	0	0	168	
COL703	Logic for Computer Science	3	0	2	4

Total Credits 12

Specialization Electives

COL724	Advanced Computer Networks	3	0	2	4
COL728	Compiler Design	3	0	3	4.5
COL729	Compiler Optimization	3	0	3	4.5
COL730	Parallel Programming	3	0	2	4
COL732	Virtualization and Cloud Computing	3	0	2	4
COL733	Cloud Computing Technology Fundamentals	3	0	2	4
COL740	Software Engineering	3	0	2	4
COL768	Wireless Networks	3	0	2	4
COL819	Advanced Distributed Systems	3	0	2	4
COL851	Special Topics in Operating Systems	3	0	0	3
COL852	Special Topics in Compilers	3	0	0	3
COL860	Special Topics in Parallel Computation	3	0	0	3
COL862	Special Topics in Software Systems	3	0	0	3
COL867	Special Topics in High Speed Networks	3	0	0	3
COL871	Special Topics in Programming Languages	3	0	0	3
COL874	Special Topics in Compilers and Language Implementation	3	0	0	3
COL876	Special Topics in Formal Methods	3	0	0	3
COL886	Special Topics in Operating Systems	3	0	0	3
COV876	Special Module on Automated Reasoning Methods for Program Analysis	1	0	0	1
COV880	Special Module in Parallel Computation	1	0	0	1
COV882	Special Module in Software Systems	1	0	0	1
COV887	Special Module in High Speed Networks	1	0	0	1
SIL765	Networks & System Security	3	0	2	4
SIL769	Internet Traffic -Measurement, Modeling & Analysis	3	0	2	4

Departmental Specialization in Theoretical Computer Science (Department of Computer Science and Engineering)

Specialization Core

COD494	B.Tech. Project Part-II	0	0	168	
COL703	Logic for Computer Science	3	0	2	4

Total Credits 12

Specialization Electives

COL726	Numerical Algorithms	3	0	2	4
COL730	Parallel Programming	3	0	2	4
COL750	Foundations of Automatic Verification	3	0	2	4

COL751	Algorithmic Graph Theory	3	0	0	3
COL752	Geometric Algorithms	3	0	0	3
COL753	Complexity Theory	3	0	0	3
COL754	Approximation Algorithms	3	0	0	3
COL756	Mathematical Programming	3	0	0	3
COL757	Model Centric Algorithm Design	3	0	2	4
COL758	Advanced Algorithms	3	0	2	4
COL759	Cryptography & Computer Security	3	0	0	3
COL830	Distributed Computing	3	0	0	3
COL831	Semantics of Programming Languages	3	0	0	3
COL832	Proofs and Types	3	0	0	3
COL860	Special Topics in Parallel Computation	3	0	0	3
COL863	Special Topics in Theoretical Computer Science	3	0	0	3
COL866	Special Topics in Algorithms	3	0	0	3
COL872	Special Topics in Cryptography	3	0	0	3
COL874	Special Topics in Compilers and Language Implementation	3	0	0	3
COL876	Special Topics in Formal Methods	3	0	0	3
COV879	Special Module in Financial Algorithms	2	0	0	2
COV883	Special Module in Theoretical Computer Science	1	0	0	1
COV886	Special Module in Algorithms	1	0	0	1

Departmental Specialization in Environmental Engineering (Department of Civil Engineering)

Specialization Core

CVD412	B.Tech. Project Part-II	0	0	126	
CVL313	Air and Noise Pollution	3	0	0	3
CVL721	Solid Waste Engineering	3	0	0	3
CVL724	Environmental Systems Analysis	3	0	2	4

Total Credits 16

Specialization Electives (8 Credits)

CVL311	Industrial Waste Management	3	0	0	3
CVL312	Environmental Assessment Methodologies	3	0	0	3
CVL727	Environmental Risk Assessment	3	0	0	3
CVL820	Environmental Impact Assessment	3	0	0	3
CVL822	Emerging Technologies for Environmental Management	3	0	0	3
CVL823	Thermal Techniques for Waste Mgmt.	3	0	0	3
CVL824	Life Cycle Analysis & Design for Environment	3	0	0	3

Departmental Specialization in Geotechnical Engineering (Department of Civil Engineering)

Specialization Core

CVD412	B.Tech. Project Part-II	0	0	126	
CVL421	Ground Engineering	3	0	0	3
CVL422	Rock Engineering	3	0	0	3
CVL423	Soil Dynamics	3	0	0	3
CVP424	Environmental Geotechniques and Geosynthetics	3	0	0	3

Total Credits 18

Specialization Electives (6 Credits)

CVL431	Design of Foundations & Retaining Structures	3	0	0	3
CVL432	Stability of Slopes	2	0	0	2
CVL433	FEM in Geotechnical Engineering	3	0	0	3
CVL434	Geotechnical Design Studio	0	0	4	2
CVL435	Underground Structures	2	0	0	2

Departmental Specialization in Structural Engineering (Department of Civil Engineering)

Specialization Core

CVD412	B.Tech. Project Part-II	0	0	126	
CVL441	Structural Design	3	0	0	3
CVL442	Structural Analysis-III	3	0	0	3
CVL443	Prestressed Concrete & Industrial Structures	3	0	0	3
CVL758	Solid Mechanics in Structural Engineering	3	0	0	3

Total Credits 18

Specialization Electives (6 Credits)

CVL763	Analytical and Numerical Methods for Struct. Engineering	2	1	0	3
--------	--	---	---	---	---

CVL765	Concrete Mechanics	3	0	0	3
CVL766	Design of Bridge Structures	3	0	0	3
CVL768	Design of Masonry Structures	3	0	0	3
CVL769	Design of Tall Buildings	3	0	0	3
CVL770	Prestressed and Composite Structures	3	0	0	3
CVL771	Advanced Concrete Technology	3	0	0	3
CVL857	Structural Safety and Reliability	3	0	0	3
CVL858	Theory of Plates and Shells	3	0	0	3
CVL859	Theory of Structural Stability	3	0	0	3
CVL862	Design of Offshore Structures	3	0	0	3
CVL866	Wind Resistant Design of Structures	3	0	0	3

Departmental Specialization in Transportation Engineering (Department of Civil Engineering)

Specialization Core

CVD412	B.Tech. Project Part-II	0	0	12	6
CVL740	Pavement Materials and Design of Pavements	2	0	2	3
CVL741	Urban and Regional Transportation Planning	2	0	2	3
CVL742	Traffic Engineering	3	0	2	4

Total Credits **16**

Specialization Electives (8 Credits)

CVL361	Introduction to Railway Engineering	3	0	0	3
CVL461	Logistics and Freight Transport	3	0	0	3
CVL462	Introduction to Intelligent Transportation Systems	3	0	0	3
CVL743	Airport Planning and Design	3	0	0	3
CVL744	Transportation Infrastructure Design	3	0	0	3
CVL746	Public Transportation Systems	3	0	0	3
CVL841	Advanced Transportation Modelling	2	0	2	3
CVL842	Geometric Design of Roads	2	0	2	3
CVL847	Transportation Economics	3	0	0	3

Departmental Specialization in Water Resources Engineering (Department of Civil Engineering)

Specialization Core

CVL382	Groundwater	2	0	0	2
CVL481	Water Resources Management	3	0	0	3
CVL482	Water Power Engineering	2	0	2	3
CVL483	Groundwater & Surface-water Pollution	2	0	0	2
CVD412	B.Tech. Project Part-II	0	0	12	6

Total Credits **16**

Specialization Electives (8 Credits)

CVL284	Fundamentals of Geographic Information Systems	2	0	2	3
CVL383	Water Resources Systems	2	0	0	2
CVL384	Urban Hydrology	2	0	0	2
CVL385	Frequency Analysis in Hydrology	2	0	0	2
CVL386	Fundamentals of Remote Sensing	2	0	2	3
CVP484	Computational Aspects in Water Resources	1	0	4	3
CVL485	River Mechanics	2	0	2	3
CVL486	Geo-informatics	2	0	2	3
CVL837	Mechanics of Sediment Transport	3	0	0	3

Departmental Specialization in Automotive Design (Department of Mechanical Engineering)

Specialization Core

MCD412	B.Tech. Project-II	0	0	14	7
MCL321	Automotive Systems	3	0	2	4

Total Credits **11**

Specialization Electives

MCL322	Power Train Design	3	0	0	3
MCL421	Automotive Structural Design	2	0	2	3
MCL422	Design of Brake Systems	2	0	2	3
MCL721	Automotive Prime Movers	3	0	0	3
MCL722	Mechanical Design of Prime Mover Elements	3	0	0	3
MCL723	Vehicle Dynamics	2	0	2	3

MCL724	Biomechanics of Trauma in Automotive Design	3	0	0	3
MCL725	Design Electronic Assist Systems in Automobiles	3	0	0	3
MCL726	Design of Steering Systems	3	0	0	3

Departmental Specialization in Technical and Innovative Textiles (Department of Textile and Fibre Engineering)

Specialization Electives

TXD402	Major Project Part-II	0	0	16	8
TXL710	High Performance and Specialty Fiber	3	0	0	3
TXL719	Functional and Smart Textiles	3	0	0	3
TXL734	Nonwoven Processes and Products	3	0	0	3
TXL740	Science & App. of Nanotechnology in Textiles	3	0	0	3
TXL752	Design of Functional Clothing	3	0	0	3
TXL773	Medical Textiles	3	0	0	3
TXL775	Technical Textiles	3	0	0	3
TXL776	Design & Manuf. of Text. Reinforced Composites	3	0	0	3

Departmental Specialization in Textile Business Management (Department of Textile and Fibre Engineering)

Specialization Electives

MCL756	Supply Chain Management	3	0	0	3
MCL760	Project Management	3	0	0	3
TXD402	Major Project Part-II	0	0	16	8
TXL381	Costing and its Application in Textiles	3	1	0	4
TXL781	Costing, Project Formulation and Appraisal	3	0	0	3
TXL782	Production and Operations Management in Textile Industry	3	0	0	3
TXL783	Design of Experiments and Statistical Techniques	3	0	0	3
TXV702	Management of Textile Business	1	0	0	1

Departmental Specialization in Appliance Engineering (Department of Electrical Engineering)

Specialization Electives

ELD451	BTP Part-II	0	0	16	8
ELL319	Digital Signal Processing	3	0	2	4
ELL365	Embedded Systems	3	0	0	3
ELL450	Special Topics in AE-I	3	0	0	3
ELL754	Permanent Magnet Machines	3	0	0	3
ELL756	Special Electrical Machines	3	0	0	3
ELL762	Intelligent Motor Controllers	3	0	0	3
ELL766	Appliance System	3	0	0	3
ELL767	Mechatronics	3	0	0	3
ELV750	Special Modules in AE-I	1	0	0	1

Departmental Specialization in Cognitive and Intelligent Systems (Department of Electrical Engg.)

Specialization Electives

ELD457	BTP Part-II	0	0	16	8
ELL409	Machine Intelligence and Learning	3	0	2	4
ELL457	Special Topics in C&IS - I	3	0	0	3
ELL704	Advanced Robotics	3	0	0	3
ELL707	Systems Biology	3	0	0	3
ELL715	Digital Image Processing	3	0	2	4
ELL741	Neuromorphic Engineering	3	0	0	3
ELL762	Intelligent Motor Controllers	3	0	0	3
ELL779	Forecasting Techniques for Power Systems	3	0	0	3
ELL784	Introduction to Machine Learning	3	0	0	3
ELL786	Multimedia Systems	3	0	0	3
ELL788	Computational Cognition and Perception	3	0	0	3
ELL789	Intelligent Systems	3	0	0	3
ELL791	Neural Systems and Learning Machines	3	0	2	4
ELL793	Computer Vision	3	0	0	3
ELL794	Human-Computer Interface	3	0	0	3
ELL795	Swarm Intelligence	3	0	0	3
ELL796	Signals and Systems in Biology	3	0	0	3

ELL798	Agent Technology	3	0	0	3
ELL799	Natural Computing	3	0	0	3
ELL880	Special Topics in Computers I	3	0	0	3
ELL881	Special Topics in Computers II	3	0	0	3
ELL888	Advanced Machine Learning	3	0	0	3
ELL890	Computational Neuroscience	3	0	0	3
ELL893	Cyber-Physical Systems	3	0	0	3
ELV780	Special Modules in Computers	1	0	0	1
ELV781	Special Module in information Processing I	1	0	0	1
ELV832	Special Module in Machine Learning	1	0	0	1

Departmental Specialization in Communication Systems and Networking (Department of Electrical Engineering)

Specialization Electives

ELD458	BTP Part-II	0	0	16	8
ELL411	Digital Communications	3	0	2	4
ELL458	Special Topics in CS&N – I	3	0	0	3
ELL713	Microwave theory and techniques	3	0	0	3
ELL714	Basic Information Theory	3	0	0	3
ELL716	Telecom Switching and Transmission	3	0	0	3
ELL717	Optical Communication Systems	3	0	0	3
ELL723	Broadband Communication Systems	3	0	0	3
ELL725	Wireless Communications	3	0	0	3
ELL785	Computer Communication Networks	3	0	0	3
ELV720	Special Modules in CS&N – I	1	0	0	1

Departmental Specialization in Electric Transportation (Department of Electrical Engineering)

Specialization Electives

ELD454	BTP Part-II	0	0	16	8
ELL334	DSP based Control of Drives	3	0	2	4
ELL450	Special Topics in AE – I	3	0	0	3
ELL454	Special Topics in ET – I	3	0	0	3
ELL750	Modeling of Electrical Machines	3	0	0	3
ELL754	Permanent Magnet Machines	3	0	0	3
ELL755	Variable Reluctance Machines	3	0	0	3
ELL764	Electric Vehicles	3	0	0	3
ELV753	Special Modules in ET – I	1	0	0	1

Departmental Specialization in Energy-Efficient Technologies (Department of Electrical Engineering)

Specialization Electives

ELD453	BTP Part-II	0	0	16	8
ELL408	Low Power Circuit Design	3	0	0	3
ELL453	Special Topics in EET – I	3	0	0	3
ELL721	Introduction to Telecommunication Systems	3	0	0	3
ELL743	Photovoltaics	3	0	0	3
ELL757	Energy Efficient Motors	3	0	0	3
ELL763	Advanced Electrical Drives	3	0	0	3
ELL765	Smart Grid Technology	3	0	0	3
ELL797	Energy Efficient Computing	3	0	0	3
ELV752	Special Modules in EET – I	1	0	0	1

Departmental Specialization in Information Processing (Department of Electrical Engineering)

Specialization Electives

ELD459	BTP Part-II	0	0	16	8
ELL459	Special Topics in IP – I	3	0	0	3
ELL460	Special Topics in IP – II	3	0	0	3
ELL714	Basic Information Theory	3	0	0	3
ELL715	Digital Image Processing	3	0	2	4
ELL718	Statistical Signal Processing	3	0	0	3
ELL719	Detection and Estimation Theory	3	0	0	3
ELL720	Advanced Digital Signal Processing	3	0	0	3
ELL784	Introduction to Machine Learning	3	0	0	3
ELL786	Multimedia Systems	3	0	0	3
ELL793	Computer Vision	3	0	0	3

ELL794	Human-Computer Interface	3	0	0	3
ELV781	Special Modules in IP – I	1	0	0	1
CRL707	Human and Machine Speech Communications	3	0	0	3

Departmental Specialization in Nano-electronic and Photonic Systems (Department of Electrical Engg.)

Specialization Electives

ELD456	BTP Part-II	0	0	16	8
ELL456	Special Topics in NE&PS – I	3	0	0	3
ELL730	IC Technology	3	0	0	3
ELL732	Micro and Nanoelectronics	3	0	0	3
ELL737	Flexible Electronics	3	0	0	3
ELL738	Micro and Nano photonics	3	0	0	3
ELL739	Advanced Semiconductor Devices	3	0	0	3
ELL740	Compact Modeling of Semiconductor Devices	3	0	2	4
ELL741	Neuromorphic Engineering	3	0	0	3
ELL742	Introduction to MEMS Design	3	0	0	3
ELL743	Photovoltaics	3	0	0	3
ELL744	Electronic and Photonic Nanomaterials	3	0	0	3
ELL745	Quantum Electronics	3	0	0	3
ELV731	Special Modules in NE&PS – I	1	0	0	1

Departmental Specialization in Smart Grid and Renewable Energy (Department of Electrical Engg.)

Specialization Electives

ELD452	BTP Part-II	0	0	16	8
ELL402	Computer Communications	3	0	0	3
ELL417	Renewable Energy Systems	3	0	0	3
ELL765	Smart Grid Technology	3	0	0	3
ELL770	Power System Analysis	3	0	0	3
ELL771	Special Topics in SG&RE – I	3	0	0	3
ELL772	Planning and Operation of Smart Grid	3	0	0	3
ELL773	High Voltage DC Transmission	3	0	0	3
ELL774	Flexible AC Transmission Systems	3	0	0	3
ELL775	Power System Dynamics	3	0	0	3
ELL789	Intelligent Systems	3	0	0	3
ELV451	Special Modules in SG&RE – I	1	0	0	1

Departmental Specialization in Systems and Control (Department of Electrical Engineering)

Specialization Electives

ELD450	BTP Part-II	0	0	16	8
ELL436	Digital Control	3	0	0	3
ELL700	Linear Systems Theory	3	0	0	3
ELL702	Nonlinear Systems	3	0	0	3
ELL703	Optimal Control Theory	3	0	0	3
ELL704	Advanced Robotics	3	0	0	3
ELL705	Stochastic Filtering and Identification	3	0	0	3
ELL707	Systems Biology	3	0	0	3
ELL708	Selected Topics in Systems and Control	3	0	0	3
ELL762	Intelligent Motor Controllers	3	0	0	3
ELV700	Special Modules in Systems and Control	1	0	0	1

Departmental Specialization in VLSI and Embedded Systems (Department of Electrical Engineering)

Specialization Electives

ELD455	BTP Part-II	0	0	16	8
ELL365	Embedded Systems	3	0	0	3
ELL455	Special Topics in V&ES – I	3	0	0	3
ELL720	Advanced Digital Signal Processing	3	0	0	3
ELL730	IC Technology	3	0	0	3
ELL731	Mixed Signal Circuit Design	3	0	0	3
ELL733	Digital ASIC Design	3	0	2	4
ELL734	MOS VLSI Design	3	0	0	3
ELL735	Analog Integrated Circuits	3	0	0	3
ELL736	Solid State Imaging Sensors	3	0	0	3
ELL740	Compact Modeling of Semiconductor Devices	3	0	2	4
ELL741	Neuromorphic Engineering	3	0	0	3

ELL747	Active and Passive Filter Design	3	0	0	3
ELL748	System-on-Chip Design and Test	3	0	0	3
ELL749	Semiconductor Memory Design	3	0	0	3
ELL833	CMOS RF IC Design	3	0	0	3
ELV730	Special Modules in V&ES – I	1	0	0	1

Departmental Specialization in Polymeric Materials (Department of Materials Science and Engineering)

Specialization Core

MLL342	Physical Chemistry of Polymers	3	0	0	3
MLL343	Polymer and Elastomer Technology	3	0	0	3
MLL344	Rheology and Processing of Polymers	3	0	2	4
Total Credits					10

Specialization Electives

MLL345	Polymer Matrix Composites	2	0	0	2
MLL341	Engineering Biomaterials	2	0	0	2
MLD413	Major project in Polymeric Materials	0	0	12	6
PTL711	Engineering Plastics and Specialty Polymers	3	0	0	3
PTL712	Polymer Blends and Composites	3	0	0	3
PTL714	Biodegradable Polymeric Materials	3	0	0	3
PTL718	Polymer Reaction Engineering	3	0	0	3
PTL720	Polymer Product and Mould Design	2	0	2	3

Departmental Specialization in Metallurgy (Department of Materials Science and Engineering)

Specialization Core

MLL361	Iron and Steel Making	2	0	0	2
--------	-----------------------	---	---	---	---

MLP362	Metallography Lab	0	0	4	2
MLL363	Metal Casting Technology	2	0	2	3
MLL364	Welding Metallurgy	2	0	2	3
Total Credits					10

Specialization Electives

MLL345	Polymer Matrix Composites	2	0	0	2
MLD414	Major project in Metallurgy	0	0	12	6
MLL365	Powder Metallurgy	3	0	0	3
MLP366	Heat treatment and Surface Engineering	2	0	2	3
MLL720	Diffusion and Kinetics	3	0	0	3
MLL732	Porous Materials	3	0	0	3
MLL734	Texture and Grain Boundary Engineering in Metals and alloys	3	0	0	3
MLL736	Tribology and Surface Engg. of Materials	3	0	0	3
MLL713	Phase transformations	3	0	0	3
MLL714	Fracture Mechanics	3	0	0	3
MLL701	Structure and Characterization of Materials	3	0	0	3
MLL715	Advanced Engineering Materials	3	0	0	3
MLL716	Engineering Failure Analysis and Prevention	3	0	0	3
MLP704	Materials Processing and Characterization Lab	1	1	4	4
MLV705	Special topics in Materials	1	0	0	1
MCL780	Casting Technology	3	0	2	4
MCL778	Design and Metallurgy of Welded Joints	3	0	2	4
APL756	Multiscale Modelling of Crystalline Materials	3	0	2	4
MCL791	Processing and Mechanics of Composite Materials	3	0	2	4
ITL717	Corrosion and its Control	3	0	0	3
ITL703	Fundamentals of Tribology	3	0	2	4

9. NON-GRADED CORE FOR UNDERGRADUATE STUDENTS

In order to synergize formal academics with informal outside-class-room learning experience, mechanisms for earning non-graded units have been introduced in the undergraduate curriculum in 2013. In order to earn these units, a student will need to involve himself/herself in activities beyond the classroom engagements. For earning 1 unit a student will typically need to work for 2-3 hours per week (28-42 hours per semester) in on-campus activities. In case of project/design/internship activities, the student engagement expected is typically 20 days of work per non-graded unit. A student would not be allowed to earn credits as well as non-graded units for the same effort. It is important that the efforts towards earning non-graded units should be distinct from that spent on earning credits. Also, the effort for earning different components of the non-graded units should be distinct, i.e., the same effort would not be evaluated for more than one non-graded component.

Non-graded core of the undergraduate curriculum comprises of the following components:

S.No.	Components	Minimum NGUs for Graduation	Maximum Countable Towards Total of 11 NGUs
1	Introduction to Engineering and Programme	1	1
2	Language and Writing Skills	2	2
3	Communication Skills/Seminar	1	1
4	NCC/NSO/NSS	1	2
5	Professional Ethics and Social Responsibility	1	2
6	Design and Practical Experience	3	5
Total units required for graduating		11	

These 11 units form a compulsory graduation requirement for all the undergraduate (B.Tech. as well as Dual degree) programmes. A student will need to earn these 11 units over the duration of the programme with special consideration and requirements for each component as detailed in the following sections. Each component would be constituted by one or more non-graded courses, and a student will need to get an 'S' grade in these courses to earn the respective non-graded unit(s). Incomplete status in such courses will be indicated by a 'Z' grade. The student would be required either to repeat the course/ activity or continue with the project/internship until such time that the evaluating faculty member/ committee is satisfied with the effort to award an 'S' grade. No partial/fractional units can be awarded. For example, if a particular activity carries 2 units, a student cannot be awarded 1 unit or fractional units for incomplete work, but would need to repeat/complete the work to the satisfaction of the evaluating faculty member/committee to become eligible for award of 2 units.

For components 3-6 in the above table, a special portal called the NGU portal is used for necessary approvals and posting of "S" grades. This portal can be accessed at <https://ngu.iitd.ac.in/index>

9.1 Introduction to Engineering and Programme

This non-graded component is aimed at orienting and exciting students in the subject of engineering in general and their respective disciplines in particular. The objectives of the component are:

- Exposing students to "Engineering" as a profession that creates wealth for nations, and as a vehicle for economic growth.
- Exposing students to Science/Engineering as a medium through which one can address problems facing the society including some of the grand challenges.
- Excite students by enabling them to appreciate the role and enormous impact of research in science/ engineering on our day to day lives.
- Enlighten students about the various career options available to them.
- Make students aware of the issues involved in engineering a product, and help them appreciate why the process of design and innovation leading to products and systems is both personally satisfying and professionally rewarding.
- Excite students about potential role models and successful alumni in engineering profession.
- Motivate students to take up some co-curricular activities on their own during their stay in the Institute.

The activities to realize the above-mentioned objectives as part of this non-graded component include:

- Understanding engineering through product dissection and reverse engineering. (The products given to students to dissect could be physical in form or in the form of videos).
- Screening of videos that bring out the strong relation between science/engineering and societal needs.
- Conducting design and innovation contests among students.
- Solving science/engineering design thinking exercises in the class.
- Lectures by successful industrialists, alumni and entrepreneurs about their journey.
- Exposure to successful research cases from the Institute and the impact of the same.
- Exposure to successful products/innovations from the Institute which have reached people/industry/society.
- Some interesting demonstrations in laboratories.
- Hands-on exercises in laboratories.
- Industry visits.
- Visits to on-going exhibitions in the city.
- Do-it-yourself projects in teams.
- Lectures by faculty, visitors, alumni on some exciting topics.

This non-graded unit is administered in the form of one non-graded course of one unit:

- NIN100 Introduction to Engineering and Programme in the first semester of the undergraduate programme.

The course coordinator of NIN100 would be identified by the Dean Academics. Apart from the main coordinator, each department offering a UG programme, will identify a departmental coordinator for this course. The departmental coordinator will engage with students of their respective departments and will cover 30-35% of the course.

It is necessary to get a satisfactory (S) grade in this course for completing the degree requirements. Attendance would be one of the main criteria for evaluation. Apart from this, active participation and quiz-based evaluation etc. would also be used as a basis to decide 'S' or 'Z' grade. The grades of NIN100 would be moderated by Dean Academics.

9.2 Language and Writing Skills

All students are required to participate in Task-Based language classes in the first two semesters. The language needs of a particular batch of the students will be assessed through an online test before the classes begin in the first semester. Then the exercises for different classes will be tailored to the language needs of those students. In general, these exercises are designed to enhance linguistic capabilities in comprehension, both reading and listening, as well as improve the ability to structure and compose ideas in spoken and written communication. Many of them will be structured in the form of competitive games. Wherever necessary principles of English Grammar will be discussed along with the nuances of technical writing. With respect to its content, some of the textual material and lectures will focus on the relationship between Engineering, Humanities and Social Sciences.

The two semesters of Language and Writing Skills is administered in the form of two courses, each of one unit: NLN100 Language and Writing Skills–I in the first semester and NLN101 Language and Writing Skills–II in the second semester. These courses are coordinated by faculty from the Department of Humanities and Social Sciences and an S grade in both NLN100 and NLN101 is generally a prerequisite to register for most undergraduate courses offered by the department of HSS. Assessment of a student towards S grade in each of these courses would typically be on the basis of attendance, participation and performance in the exercises. A student could also be prescribed self-learning exercises or additional practice sessions during vacations as requirement for securing S grade. Student's involvement, during regular semester, would typically be two hours per week. The grades of these courses are moderated by the Dean Academics.

9.3 NCC/ NSO/ NSS

A student is required to choose one of NCC/NSO/NSS during the first semester, and complete the requirements preferably within the first four registered semesters. Students will be required to earn a minimum of 1 non-graded unit from one of these activities, by completing at least 40 hours of work. Students can earn upto 2 units by putting in 80 hours of work. The faculty coordinators of NCC/NSO/NSS decide and announce the policies on earning non-graded units in these activities from time to time.

9.4 Professional Ethics and Social Responsibility

There is increasing consensus worldwide that engineering ethics should be incorporated into the engineering curriculum to provide students with an exposure to the kind of professional ethical dilemmas they might face on an individual basis as well as in the larger context of ethical aspects of technology development. Workshops, discussion/ debates, use of theatre-in-education, case-study based approaches, etc. are often used for illustration and discussion of engineering ethics. Such inputs could be provided in a stand-alone manner, integrated into existing courses or both. The objective of this non-graded component is to sensitize students about Professional Ethics and Social Responsibility (PESR) through a combination of the above-mentioned approaches, supplemented by discussion fora and supplementary materials, to help students to become ethical professionals. A student is required to complete minimum of 1 non-graded unit in this component through activities divided into 3 core courses. The courses NEN100 and NEN101 together correspond to 0.5 non-graded unit and the course NEN300 also corresponds to 0.5 unit. Besides, the students can earn an additional unit through one of the two alternatives NEN202/ NEN203 as discussed below. Thus, the courses under PESR are:

- i) NEN100 Professional Ethics and Social Responsibility – I (core)
- ii) NEN101 Professional Ethics and Social Responsibility – II (core)
- iii) One of the following two courses: (optional)
 - a. NEN202 PESR Workshops
 - b. NEN203 PESR Projects
- iv) NEN300 Case Studies in Professional Ethics (core)

Core Requirements

NEN100 and NEN101 are compulsory for all students, and these courses involve interactive sessions of a group of students with a resource person in the first and second semesters respectively. The student will earn 0.5 unit by getting 'S' grade in both these courses.

In NEN300 Case Studies in Professional Ethics, every student will work on at least two case studies related to professional ethics, followed by discussions on the same, moderated by a resource person. The details on how to select the case studies and the mode of discussions and their evaluation would be decided by the concerned resource person. The student will earn 0.5 unit by getting an 'S' grade in this course.

Activities for Additional NGU

The students can choose to earn 1 more NGU under PESR by participating in any one out of a large variety of activities relevant to the core themes of PESR. With the considerable amount of flexibility allowed in the choice of activities, each student desirous of earning this unit should be able to identify an activity of interest to him / her under the purview of PESR. These activities have been divided into two broad categories, viz., (a) PESR workshops (b) PESR projects, each of which corresponds to a separate course number NEN202 and NEN203 respectively. After a student has got 'S' grades in NEN100 and NEN101, the student can register for NEN202/ NEN203. 'S' grade in any of these two courses will get the student 1 NGU.

NEN202 PESR Workshops

Under NEN202 (PESR Workshops), students can participate in one workshop of 5 days duration if the workshop is held in person. These workshops are generally organized on campus by NRCVEE soon after major examinations at the end of every semester. Alternatively, online workshops can be held with about 40 hours of engagement through 2-3 hour sessions during the semester or during vacation period. These workshops are organized by NRCVEE and would be conducted by resource persons from within or outside the Institute. These workshops could be pertaining to any of the themes relevant to PESR and the in-person ones could be held during mid-semester break / summer / winter vacation. The students must follow the procedure announced by the faculty coordinator to register for a workshop. The 'S' grade for attending a workshop will be awarded only if the student attends all sessions of the workshop on all the days for its full duration.

NEN203 PESR Projects

Under NEN203 (PESR Projects), the students can take up projects under the guidance of one or more faculty members to make positive contribution to campus life. This could include promoting wholesome practices on campus such as:

- ethical practices particularly among students through specially directed efforts;
- peer assistance for the students in need of help academically or otherwise;
- sustainable practices on campus like resource conservation, waste management, use of renewable resources and the like;
- working on technology for a social cause etc.

This work could be done during a semester or mid-semester break or summer/winter vacation. The student must submit a project proposal on the NGU portal, with explicit statement of deliverables, through his/her faculty supervisor(s), for approval by the PESR coordinator. If the work is taken up in a team, each student's share of work must be defined in the proposal. It is expected that each student puts in at least 40 hours of effort in the project. On completion of the project, the students should submit a completion request online along with a report of the work done, again through the faculty supervisor, who should certify that each student has completed his/her share of the deliverables and each student has put in at least 40 hours of work into the project.

If a student gets selected in one of the nation building initiatives organized by reputed organizations, the student can identify a faculty supervisor who can be informed of the work done as part of these initiatives. On successful completion of the work, the student can apply on the NGU portal for earning NEN203 units through the faculty supervisor, who can certify the completion of the concerned activity.

Table 9.2 summarizes the requirements of the non-graded component on Professional Ethics and Social Responsibility.

Table 9.2 : Summary of Requirements of the Non-Graded Component on Professional Ethics and Social Responsibility

S. No.	Course	Period of Activity	Description	Requirement for 'S' grade	No. of units
A Core Requirement					
1.	NEN100 Professional Ethics and Social Responsibility–I	1 st Semester	3-4 sessions of 2 hours each with a resource person. Theme of the sessions to be announced by the faculty coordinator	Participation in all the sessions held	0.5 (both courses together)
2.	NEN101 Professional Ethics and Social Responsibility–II	2 nd Semester	3-4 sessions of 2 hours with a resource person. Theme of the sessions to be announced by the faculty coordinator	Participation in all the sessions held	
3.	NEN300 Case Studies in Professional Ethics	After 6 th semester: during vacation or 7 th /8 th semesters	Work on two case studies on professional ethics; participate in discussions moderated by a resource person.	Participation in all the sessions held along with presentation of case studies	0.5
B Practical Activities for Additional NGU					
4.	NEN202: PESR Workshops	If in-person: Mid-semester breaks/ summer/ winter vacations. If online: can be held during the semester as well	Participation in intense ON-CAMPUS workshops approved by Dean Academics, of 5 days duration if in-person and 40 hours duration if online conducted by professional resource persons, with special emphasis on themes related to PESR.	'S' grade to be awarded only for attending the workshop for full duration.	1

5.	NEN203: PESR Projects	Summer/ winter vacation /mid- semester break or during a semester.	Taking up on-campus projects under the guidance of a faculty mentor, related to any of the topics relevant to PESR, such as (but not limited to) A. Promoting ethical practices on campus in various spheres particularly related to student life on campus. B. Strengthening the existing systems and designing and implementing new ones for an active student community participation in addressing the academic as well as other problems of student community. C. Developing socially relevant technologies D. Promoting Sustainable Practices in hostels, academic area, residential areas etc., involving activities pertaining to conservation of water / electricity / paper / other resources, waste management, promoting use of bicycles, etc.	Prior approval of project proposal by PESR coordinator explicitly specifying deliverables and work share of each student in case of group projects; Completion of the project deliverables identified in the proposal - It must involve at least 40 hours of work by each student along with submission of a report on the NGU portal.	1
----	-----------------------	---	--	--	---

9.5 Communication Skills / Seminar

The objective of this non-graded component is to provide the students with an opportunity to develop their skills in preparing write-ups, making presentations, and reading /listening to others' write-ups/ presentations. A student would be required to earn 1 non-graded unit under this component between 5th and 8th semesters through any of the following:

- (i) Attending one of the topic specific seminar courses (XXQ301, XXQ302, etc.) introduced by the parent Department of a student (for example ELQ301 – Seminar on Embedded Systems – 1 unit) or attending a seminar course (XYQ301, XYQ302 etc.) offered by any other Department/Centre/School. These courses would be non-credit electives, offered in each semester. These seminar sessions would be held for two hours per week. Many such courses could run in parallel.
- (ii) Participating in optional seminars which may be part of regular courses; for example regular 'L' courses can have an optional seminar component (e.g. ELL711 Optical Communications can have optional seminar component of 1 unit). This would, like any other seminar course, need to have seminar sessions of 2 hours duration every week for a whole semester. In such a case, a student should register for XXQ30y, and the course coordinator would send recommendations for 'S' grades to the Dean Academics, duly moderated by the Moderation Committee of the concerned Department/Centre/School.
- (iii) By participating in special workshops on Communication Skills approved by Dean Academics. The faculty coordinator in charge of the workshop would submit a list of students who completed the activity with 100% attendance in all sessions on all days of the workshop for award of S grade in NQN301.
- (iv) By submitting documentary evidence of excellence in debating and/or writing as certified by faculty in-charge of these activities, to the Dean Academics. In all such cases, the student should submit documentary evidence online, as detailed below:
 - A student who wins first, second or third position in any event/competition conducted at inter-hostel level, by BRCA or by BSP or by BSW would qualify for this option. The event/competition must

be either a debate/declamation/extempore. Since many such events do not have certificates issued, the student must submit a letter signed by the warden or the president of the respective board (in case of BRCA, president of the club would also suffice) stating the date, time, venue of the event/competition along with the number of participants and position secured. In case number of participants is less than 20, the event shall not be counted.

- A student who performs as a compere for any of the Institute functions (only those listed in the Institute calendar). The student will need to produce a signed letter from the faculty in-charge of the Institute function stating the student's role as compere. The letter must include the date, time, venue and duration of the event. Any event lasting less than 1 hour will not be counted.
- A student winning a technical paper presentation award during TRYST will need to submit a copy of the certificate and the abstract of the paper presented. Technical publications in Journals or Conferences would also be considered, provided (i) the number of authors of the paper does not exceed 2 and (ii) the faculty member supervising the work certifies that the paper was written by the concerned student.

A minimum of three such documents certified by the faculty in charge of the Board/Club/Activity as mentioned above would qualify a student to earn one unit of Communication Skills/Seminar. In each case, before recommending the award of non-graded units for the above activities, the faculty incharge of the Board/Club/Activity should keep in mind that a student engagement/effort (including preparations and the actual event) of about 40 hours would be necessary for the award of one non-graded unit.

In cases of options (i), and (ii) above, the faculty member in charge of the course should ensure that the student has 100% attendance in the seminars and has done a satisfactory task of his / her contribution to the course: the write-up, presentation, etc. before awarding an 'S' grade. These grades would be moderated by the respective Department / Centre / School. In case of unavoidable absence of up to 3 seminar sessions, appropriate compensation mechanism should be announced by the faculty member at the beginning of the course. For absence beyond 3 sessions, S grade cannot be awarded.

An Institute level Coordinator for Communication Skills/Seminar, appointed by the Dean Academics, would serve as the course coordinator of NQN301. An Institute level committee would moderate the non-graded units for Communication Skills / Seminar recommended for activities other than the courses XXQ30y.

9.6 Design / Practical Experience

The objective of this non-graded component is to give opportunities to students to learn in an informal setting. This mode of learning, is often more effective than conventional lectures/laboratory work. Second and even more important objective of this non-graded component is to inculcate design thinking among students and facilitate them to gain some design immersion experience. Design/Practical Experience (DPE) component can promote learning by doing which does two important things: Firstly, it allows students to immerse themselves in the environment in which work is to be done, so that they can understand the values and expectations of the target beneficiaries. Secondly it enables a fresh look at problems, not only at the ways of defining them, but also at the ways to solve those including skill-sets that are required to address them. This approach signifies a shift from problem based learning (acquisition of knowledge) to project based learning (application of knowledge), in which the projects are grounded in problems outside the classrooms and laboratories, in everyday scenarios. Thus, DPE bridges division between the curricular and the co-curricular components, and encourages the curiosity and involvement that arises from total absorption in a subject of interest.

As a part of this requirement, every student is expected to earn a minimum of three non-graded units of DPE to complete the degree requirements. To earn one unit of DPE, a student is expected to put in 28-42 hours of effort or 20 working days depending on the type of activity. To earn two units of DPE, a student needs to put in 56-84 hours of effort or 40 working days depending on the nature of activity. These units can be earned in multiple ways during the semester as well as during vacation and mid-semester breaks:

- Courses with design focus without any regular graded credits, which are designated to give design/practical experience units.
- Courses (core or elective) with optional design/practical experience component.
- Summer/semester internships by students in R&D/Industry/Universities in India or abroad.

- Summer/winter/semester projects under the guidance of faculty of the Institute.
- Participation in design/innovation projects by Innovation Center/CAIC, etc.
- One time activity such as design/practical experience workshop/course/event during semester / vacation/mid-semester breaks, etc.

DPE activities are not restricted to design of physical products but can also include system level design and experience. For example a team of students who under the supervision of faculty in collaboration with an NGO, would like to design a new financial inclusion system for marginalized section of population too can earn design/practical experience units.

The operational modalities of implementing the above-mentioned activities so that students can earn the required non-graded units, are presented in the following paragraphs.

9.6.1 Management of Non-graded DPE Units

Each Department offering UG programme(s) would constitute a DPE Committee with a Departmental DPE Coordinator to manage the non-graded Design/Practical Experience units.

- a) The Departmental DPE Committee would coordinate with Office of Career Services (OCS) to identify and vet industries for internships.
- b) The committee would also examine other types of internships (in Universities, research laboratories, start-ups etc.) requested by students and approve or deny as per a policy defined by the Department.
- c) Students of the Department desirous of earning non-graded DPE units through any other mechanism listed above should request permission of this committee before embarking on the activity. The committee would also decide on the award of non-graded DPE units for all such activities for the students of the Department through appropriate evaluation mechanisms.
- d) The committee would be responsible to evaluate the design activities carried out by the students during internships and recommending award of the non-graded DPE units, or continuation of the internship activity for more days to become eligible for the units, as per the efforts of the students during the internship. DPE Committee will moderate all Design units awarded to students of that Department. The Departmental DPE Coordinator also has responsibility of ensuring that units earned by heterogeneous activities meet the requirements in terms of learning efforts and experience.
- e) The Dean Academics will appoint an Institute DPE Coordinator for Design / Practical Experience units.
- f) Departmental DPE Coordinators, Institute DPE Coordinator and Associate Dean Academics-Curriculum together will form an institute level committee to moderate the non-graded units awarded under interdisciplinary work including the activities carried out by students in Departments / Centers / Schools not offering UG programmes. This committee would also review and modify policies as well as modalities for administering DPE units.

9.6.2 Activities Covered Under Design/Practical Experience

9.6.2.1 Specialized Courses Related to Design/Practical Experience (Maximum 2 Units)

Departments/Centres/Schools may offer a basket of courses that will not have any credits associated with them but will have only Design/Practical Experience units linked to them. In other words, on successful completion of such courses the students will earn only DPE units but no graded credits. These courses offered by Departments / Centers / Schools can be of one unit (28-42 hours of student effort) or two units (56-84 hours of student effort). Faculty offering these courses will award these units on successful completion of the course requirements, and the same would be moderated by the Departmental Committee for DPE in case of Departments offering undergraduate programmes. For other Departments/Centres/Schools, the moderation would be done by the Institute level DPE committee.

9.6.2.2 Semester/Summer/Winter Projects Under the Guidance of Institute Faculty (Maximum 2 Units)

Some of the co-curricular activities in the Institute that pertain to team based product building such as Robotics, Automobile, IGEM, Aero-modelling etc. can also be considered for earning DPE units. Students who successfully complete SURA/DISA projects will also be eligible for DPE units. Besides, students may also opt for working on

semester / summer / winter projects involving design / practical experience activity under the guidance of faculty of the Institute. In order to be evaluated for DPE Units in such cases, a student should register for XXD35y Minor Design Project floated by the parent Department XX of the student. In case the project is interdisciplinary or it is offered by faculty of other Departments / Centres / Schools, the faculty supervisor of the project may advise the students to register for NDN35y Minor Design Project. In either case, the project would be evaluated by the faculty supervisor.

The courses XXD351 – XXD355 would be Minor Design Projects with 1 non-graded DPE unit, and XXD356 – XXD358 would be Minor Design Projects with 2 non-graded units each. Courses NDN351 – NDN358 would also follow a similar definition.

9.6.2.3 Regular Courses with Optional Design/Practical Experience Component (Maximum 2 Units)

Course coordinators of regular core and elective courses can also offer optional design component in their courses. A proposal for this should be sent to the Departmental DPE committee prior to the commencement of the course by the Course Coordinator. This would be notified to students by the Departmental DPE committee and also announced to the students by the course coordinator. Successful completion of the course will give graded credits to students and at the same time they will be eligible for earning (1 or 2) design units if they successfully complete the optional DPE component. The course coordinator will recommend these DPE units on successful completion of the assigned work. This would be moderated by the Departmental Committee for DPE. In case the course is offered by Departments / Centres / Schools which do not offer a UG programme, the notification prior to beginning of the course and moderation after the end of the course would be done by the Institute level DPE committee. In order to be evaluated for DPE Units, a student should register for XXD35y Minor Design Project or NDN35y Minor Design Project as the case may be.

9.6.2.4 Summer Internships (Maximum 2 Units)

Students can undertake a minimum of 40 working days of internship to earn two design practical experience units during summer vacations in Industry, R&D institutions or Universities in India or abroad. This cannot be earned in parts. For example, 1 NGU cannot be claimed for 20 working days of internship. This would be administered by the Departmental Committee for DPE with the help of the Office of Career Services (OCS). Students are required to get approval for taking up internship in the concerned Institute through the NGU portal prior to proceeding for the internship if they wish to claim NGU for the internship. The Departmental DPE Committee would also be responsible for appointing a faculty supervisor for the internship. Students can proceed with the internship after the Departmental Committee for DPE approves the same. Design units for the internship would be awarded by the Departmental Committee after evaluation at the end of internship period. Rules governing administration of internships are given in section 9.6.3. In case an internship pertains to areas of expertise outside those of the parent Department, the DPE Committee may co-opt faculty members from other Departments / Centres / Schools for evaluating / supervising such internships.

9.6.2.5 One-Semester Internship (Maximum 5 Units)

Students can opt for one semester internship in Industry, R&D institutions or Universities in India or abroad, for a minimum of 100 working days, by appropriately planning for completion of credit requirements for the degree. The student can also opt for a break in coursework for a semester to initiate or work for his / her start up. These are the only two activities upon successful completion of which students would be eligible for 5 DPE units. It is mandatory that student's work during the one-semester internship is supervised by two mentors, one from the Institute (appointed by the DPE Committee of the student's Department) and another from the host organization. In case of semester break for a start-up, students will work under the mentorship of a faculty member of the Institute. Students desiring to opt for one semester internship or semester break for start-up as mentioned above are required to plan well in advance and submit a project proposal in consultation with their supervisors (in case of internship) or faculty mentor (in case of start-ups). Students can proceed with the internship / startup activity only after the Departmental Committee for DPE approves the same. DPE units for the activity would be awarded by the Departmental DPE Committee after evaluation at the end of the internship / startup period. In case an internship / startup pertains to areas of expertise outside those of the parent Department, the DPE Committee may co-opt faculty members from other Departments / Centres / Schools for evaluating / supervising such activities. Details of the procedure are given in section 9.6.3 on internships.

A semester in which a student earns DPE units through semester-long internship or start-up as discussed above would be counted as a registered semester for graduation requirements. In case the DPE committee does not approve the award of 5 units for such activity, the semester would not be counted as a registered semester.

9.6.2.6 One Time Design/Practical Experience Module (1 Unit)

One time DPE modules can be offered by Institute faculty as well as working professionals who would like to engage students in a workshop/course related to design/practical experience. A proposal for such a module should be sent by faculty member coordinating the course through the concerned Department/Centre/School to the Institute DPE Committee for approval. These modules can be typically of 28-42 hours duration, and may be offered during mid-semester breaks, winter/summer vacations and even during non-class hours in the semester.

Table 9.3 summarizes the information presented in section 9.6.2. Detailed rules pertaining to internships and their administration are given in section 9.6.3.

Table 9.3 : Implementation and Evaluation Plan for Design/Practical Experience Units

Activity	Norms for the Activity	Criteria for awarding Units	No. of Units	
			Min	Max
Courses with design focus (which are primarily design courses or have significant design component)	Courses offered as per Institute procedure	Registration by the student in the respective course; Evaluation by course coordinator; Moderation by DPE committee of Department/Institute	1	2
Courses with optional design/practical experience component	Course Coordinator provides intimation to Departmental / Institute DPE Committee about offering optional design units prior to commencement of the course	Student to raise request on the NGU portal for prior permission, forwarded by course coordinator; Prior Approval by DPE coordinator; Evaluation by course coordinator; Moderation by DPE committee of Department/Institute	1	2
4-week project with Institute Faculty during winter/summer (20 working days)	Notification of projects by DPE Committee of Student's Department/Institute	Student to raise request online for prior permission; Prior approval by DPE Committee of Student's Department; Evaluation by Faculty Supervisor of the project; Completion approval request by student forwarded through supervisor; Moderation by DPE committee of Department/Institute	1	1
8-week project with Institute Faculty including SURA, DISA, etc. (40 working days)	Notification of projects by DPE Committee of Student's Department/Institute OR Announcement and selection by appropriate Institute bodies	Student to raise request online for prior permission; Prior approval by DPE Committee of Student's Department; Evaluation by Faculty Mentor of the project/appropriate committee; Completion approval request by student forwarded through supervisor; Moderation by DPE committee of Department/Institute	2	2
Internship during summer with Industry/R&D/University (40 working days)	Arranged by OCS or self-arranged by the student	Student to raise request online for prior permission; Prior approval by DPE Committee of Student's Department; Monitoring by Internship supervisor; Completion approval request by student forwarded through supervisor; Evaluation and Moderation by DPE committee of Department/Institute	2	2

One semester internship (100 working days) or One semester break for own start-ups (singly or jointly)	Arranged by OCS or self-arranged by the student	Student to raise request online for prior permission; Prior approval of Institute DPE Committee on recommendation from DPE committee of Student's Department; Monitoring by Internship supervisor; Completion approval request by student forwarded through supervisor; Evaluation and Moderation by DPE committee of Department/Institute	5	5
Participation in design/project activity under the supervision of faculty during semester	Notification of projects by DPE Committee of Student's Department/Institute or the Student to approach the faculty	Student to raise request online for prior permission; Prior approval by DPE Committee of Student's Department; Evaluation by Faculty Mentor of the project; Completion approval request by student forwarded through supervisor; Moderation by DPE committee of Department/Institute	1	2
Participation in design/practical/experience workshop/course/event organized by industry/other institutions or visitors including visiting faculty	Proposal for activity to be recommended by faculty coordinator or Department DPE Committee and approved by Institute DPE Committee	Registration by the student in the activity; Evaluation by Faculty Coordinator and Visiting Faculty offering the course if any; Moderation by DPE committee of Department/Institute	1	1
Participation in design/innovation activities of clubs (eg. Robotics, IGEM, etc.)	Notification by the Faculty in-charge of the corresponding activity	Student to raise request online for prior permission; Prior approval by DPE Committee of Student's Department; Evaluation by faculty in-charge of activity/clubs; Completion approval request by student forwarded through supervisor; Moderation by Institute DPE committee	1	2

- A student cannot register for more than 3 non-graded DPE units per summer semester or per registered semester in which a student is on regular academic activity. To take part in activities that can result in more than 3 DPE units, a student has to take the semester off from regular courses.
- A single activity cannot be evaluated for more than one purpose. For example, the same project cannot be submitted for graded credits as well as for design units.

9.6.3 Rules Governing Internship

- i) Internships for DPE units are permitted only in one of the two following formats:
 - a. Summer internship of 40 days duration, in which a student can earn 2 DPE units.
 - b. Semester-long internship of 100 days duration, in which a student can earn 5 DPE units.

No other format of internship would be considered for the award of DPE units. DPE units would be awarded only if training for the stipulated number of working days, as mentioned above, is completed to the satisfaction of the concerned Departmental DPE Committee. DPE units would not be awarded against partial completion of the internship duration.
- ii) A student can choose from one of the following options in order to complete the requirements of Non-Graded component of Design/Practical Experience:
 - a. One semester internship, accounting for 5 DPE units.

- b. One summer internship, accounting for 2 DPE units and 1 to 3 DPE units from other activities at the Institute
- c. Two summer internships, accounting for a total of 4 DPE units, and if desired, 1 DPE unit from other activities at the Institute
- d. No internships: all DPE units can be earned through design/project activities at the Institute
- iii) A student can do at most two internships for DPE units, during his/her stay at the Institute. If any student does more than two internships, DPE units will be awarded for the first two registered internships only.
- iv) Summer internships are allowed in the summer after the 4th registered semester of the student or later. Semester Internships are permitted from the 7th registered semester or later.
- v) Internships are permitted in industry, research laboratories or academic institutions involved in research, development and/or technology transfer. Any student opting for semester long internship may also be allowed to work on a start-up. All internships must be approved by the departmental DPE committee in advance. In the case of non-industry internships, the work should be research / development / practice oriented, and not classroom course work.
- vi) In all cases, for award of DPE units, after completion of the internship, the work must be evaluated by the DPE committee of the student's Department. In case the work is found wanting in any respect, the student(s) will be advised to do more work and reappear before the committee. In any case, partial award of DPE units would not be allowed.
- vii) For self-arranged internships, any documentation regarding the bona fide status of students (while applying for training) will be provided by UG section.

9.6.3.1 Registration Procedure for Internships

Summer Internships:

- i) At the beginning of first semester of each academic year, the data of all students who have earned at least 30 credits would be automatically enrolled by the OCS for internship in the subsequent summer.
- ii) At the beginning of the internship in the following summer, the student must have completed 50 credits to be eligible.
- iii) OCS sends out information to the students about the companies offering summer internships. Interested students can apply for the same.
- iv) The students can also arrange for the internships on their own.
- v) If a student is selected for an internship through OCS, he/she is bound to accept the internship. If the student does not take up or complete the internship, he/she will be debarred from all further OCS activities including further internship opportunities and placement procedure. This is to discourage non-serious students from depriving other students of the opportunity, and damaging the reputation of IIT Delhi with the companies offering internships through OCS.
- vi) The OCS would handle correspondences and training certificates of all internships arranged by the OCS.
- vii) OCS will try and arrange internships for as many students as it can. However, it may not be possible for the OCS to arrange internships for all the students who participate in the process.
- viii) The OCS typically starts the process of selections for internships in August and ends in February- March. The exact dates would be notified by the OCS each year.
- ix) To claim DPE units for summer internships, a student is required to initiate activity XXT200 or XXT300 on the NGU portal prior to the commencement of the internship. A student should register in XXT200 if it is his/her first summer internship and XXT300 if it is second summer internship. The approval of initiation request will be as per the rules and regulations of the academic unit, which holds for both OCS arranged as well as self-arranged internships
- x) At the end of summer internship, a student is required to submit training report and training certificate to the department DPE coordinator. Further, student will also need to raise the completion request for the registered activity XXT200/300. DPE units will be awarded after the due evaluation procedure of the respective academic unit.

Semester Internship:

- i) Semester internship, as mentioned in section 9.6.2.5, is permitted in the seventh registered semester or later, for students with at least 75 earned credits.
- ii) A student needs to submit a request on the NGU portal for prior approval of semester internship. The request for internship will be evaluated by the DPE committee of the student's parent Department and approved by the Institute DPE committee upon recommendation of the former.
- iii) Process of monitoring /mentoring the internship is described in section 9.6.2.5. Upon completion, the student should submit a request on the NGU portal for approval of the completion of the internship through the supervisor and Departmental DPE committee to the Institute DPE committee. The grade for semester internship is awarded by the Institute DPE committee.

The list of courses offered in connection with non-graded units listed in sections 9.1-9.6 along with the respective pre-requisites is summarized in Table 9.4.

Table 9.4 : Summary of courses for non-graded unit

S. No.	Course Number	Course Name and/or Description	Pre-requisite(s)	No. of Units
Introduction to Engineering & Programme: 02 units				
1	NIN100	Introduction to Engineering and Programme in the first semester	—	1
Language and Writing Skills: 02 units				
2	NLN100	Language and Writing Skills – I in I semester	—	1
3	NLN101	Language and Writing Skills – II in II semester	NLN100	1
NCC/NSO/NSS: Minimum 01 unit – Maximum 02 units				
4	NCN100	NCC	—	2
5	NCN103	NCC	—	1
6	NPN100	NSO	—	2
7	NPN103	NSO	—	1
8	NSN100	NSS	—	2
9	NSN102	NSS	—	1
Professional Ethics and Social Responsibility: Minimum 01 unit – Maximum 02 units				
10	NEN100	Professional Ethics and Social Responsibility – I in first semester – 6-8 hours	—	0.5 (for both together)
11	NEN101	Professional Ethics and Social Responsibility – II in second semester – 6-8 hours	NEN100	
12	NEN202	PESR Workshops: 5 days or 40 hours	NEN101	(Any one of the two) 1
13	NEN203	PESR projects: 40 hours of work followed		
14	NEN300	Case Studies in Professional Ethics (6 hours of class engagement + preparation of case studies)	NEN101	0.5

Communication Skills / Seminar: 01 units				
15	XXQ301, XXQ302, etc.	Topic specific Seminar courses introduced by parent Department	EC 50	(Any one) 1
16	XYQ301, XYQ302, etc.	Additional Seminar courses introduced by any other Department/Centre/School	EC 50	
17	NQN301	Seminar component of regular courses OR Three extracurricular activities involving communication skills	EC 50	
Design/Practical Experience: Minimum 03 units – Maximum 05 units				
18	XXD351	Minor Design Project – 1	EC 30	1
19	XXD352	Minor Design Project – 2	EC 30	1
20	XXD353	Minor Design Project – 3	EC 30	1
21	XXD354	Minor Design Project – 4	EC 30	1
22	XXD355	Minor Design Project – 5	EC 30	1
23	XXD356	Minor Design Project – 6	EC 30	2
24	XXD357	Minor Design Project – 7	EC 30	2
25	XXD358	Minor Design Project – 8	EC 30	2
26	NDN351	Minor Design Project – 1	EC 30	1
27	NDN352	Minor Design Project – 2	EC 30	1
28	NDN353	Minor Design Project – 3	EC 30	1
29	NDN354	Minor Design Project – 4	EC 30	1
30	NDN355	Minor Design Project – 5	EC 30	1
31	NDN356	Minor Design Project – 6	EC 30	2
32	NDN357	Minor Design Project – 7	EC 30	2
33	NDN358	Minor Design Project – 8	EC 30	2
34	XXT200	Summer Internship – 1	EC 30	2
35	XXT300	Summer Internship – 2	XXT200	2
36	XXT400	Semester Internship	EC 75	5
<p>In all above course descriptions, XX and XY stand for the two-letter prefix corresponding to course numbers of academic units (Table 1 of Chapter 1): example, XXD351 corresponding to Department of Textile and Fibre Engineering would be TXD351.</p>				

9.7 Overlapping Activities

Many of the activities listed under a given component in sections 9.1-9.6 could also qualify as valid activities under other non-graded components: for example, a technical project done as part of NEN203 may qualify to be submitted for DPE units under XXD35y, etc. Some of the technical projects may also qualify as valid activities under Minor/Mini/Major projects towards earning graded credits. In this regard, the following would be strictly followed: In case a project is evaluated for graded credits or for any other non-graded activity, it would not be allowed to be re-submitted for any other non-graded unit. While submitting the completion request of the project online, a student should submit an undertaking to this effect, approved online by the faculty supervisor of the project.

- a) In the summer when student has registered for Summer Internship (either through OCS or self-arranged); they cannot be registered for any course or other institute activity.
- b) Additional work which is not evaluated for such projects, either done prior to such projects or done after the completion of such projects, could be considered. In such a case, prior written permission must be taken from the concerned committee (PESR, DPE, etc.), explicitly describing components of work being submitted for the other graded / non-graded evaluations and for the current submission separately. In this regard, note the following example:
 - The workshops organised by NSS and under NEN202 would be generally distinct. Under NEN202, workshops would have minimum duration of 5 days and would be designated as "PESR WORKSHOP". Workshops organized by NSS would not be counted for NEN202 and vice-versa.

10. POSTGRADUATE PROGRAMME STRUCTURES

Master of Science in Chemistry

Department of Chemistry

The overall credits structure

Category	PC	PE	OC	Total
Credits	60	9	6	75

Program Core

CML511	Quantum Chemistry	3	0	0	3
CML512	Stereochemistry & Organic Reaction Mechanisms	3	0	0	3
CML513	Photochemistry & Pericyclic Reactions	3	0	0	3
CML514	Main Group Chemistry	3	0	0	3
CML515	Instrumental Methods of Analysis	3	0	0	3
CML521	Molecular Thermodynamics	3	0	0	3
CML522	Chemical Dynamics & Surface Chemistry	3	0	0	3
CML523	Organic Synthesis	3	0	0	3
CML524	Transition and Inner Transition Metal Chemistry	3	0	0	3
CML525	Basic Organometallic Chemistry	3	0	0	3
CML526	Structure & Function of Cellular Biomolecules	3	0	0	3
CML631	Molecular Biochemistry	3	0	0	3
CMP511	Lab I	0	0	4	2
CMP512	Lab II	0	0	4	2
CMP521	Lab III	0	0	4	2
CMP522	Lab IV	0	0	4	2
CMD631	Project Part I	0	0	12	6
CMD641	Project Part II	0	0	20	10
Total Credits				60	

Program Electives

CML661	Solid State Chemistry	3	0	0	3
CML662	Statistical Mechanics & Molecular Simulation Methods	3	0	0	3
CML663	Selected Topics in Spectroscopy	3	0	0	3
CML664	Group Theory & Spectroscopy	3	0	0	3
CML665	Biophysical Chemistry	3	0	0	3
CML671	Supramolecular Chemistry	3	0	0	3
CML672	Recent Trends in Organic Chemistry	3	0	0	3
CML673	Bio-organic and Medicinal Chemistry	3	0	0	3
CML674	Physical Methods of Structure Determination of Organic Compounds	3	0	0	3
CML675/740	Chemistry of Heterocyclic Compounds	3	0	0	3
CML681	Physical Methods in Inorganic Chemistry	3	0	0	3
CML682	Inorganic Polymers	3	0	0	3
CML683	Applied Organometallic Chemistry	3	0	0	3
CML684	Bio-inorganic Chemistry	3	0	0	3
CML691	Microbial Biochemistry	3	0	0	3
CML692	Food Chemistry and Biochemistry	3	0	0	3
CML693/739	Applied Biocatalysis	3	0	0	3
CML696	Physical Organic Chemistry	3	0	0	3
CML670	Organic Chemistry of Biological Systems	3	0	0	3
CML743	Physical Organic Chemistry- Advanced	3	0	0	3

Sem.	Courses (Number, Abbreviated Title, L-T-P, Credits)								Lecture courses	Contact h/week				Credits
	L	T	P	Total	L	T	P	Total						
I	CML511 Quantum Chemistry (3-0-0) 3	CML512 Stereo-chemistry & Organic Reaction Mechanisms (3-0-0) 3	CML513 Photochemistry & Pericyclic Reactions (3-0-0) 3	CML514 Main Group Chemistry (3-0-0) 3	CML515 Instrumental Methods of Analysis (3-0-0) 3		CMP511 Lab-I (0-0-4) 2	CMP512 Lab-II (0-0-4) 2	5	15	0	8	23	19
II	CML521 Molecular Thermodynamics (3-0-0) 3	CML522 Chemical Dynamics & Surface Chemistry (3-0-0) 3	CML523 Organic Synthesis (3-0-0) 3	CML524 Transition and Inner Transition Metal Chemistry (3-0-0) 3	CML525 Basic Organometallic Chemistry (3-0-0) 3	CML526 Structure & Function of Cellular Biomolecules (3-0-0) 3	CMP521 Lab-III (0-0-4) 2	CMP522 Lab-IV (0-0-4) 2	6	18	0	8	26	22
Summer														
III	CML631 Molecular Bio-chemistry (3-0-0) 3	PE-1 (3-0-0) 3	PE-2 (3-0-0) 3	PE-3 (3-0-0) 3	CMD631 Project Part-I (0-0-12) 6				4	12	0	12	24	18
IV	OE-1 (3-0-0) 3	OE-2 (3-0-0) 3	CMD641 Project Part-II (0-0-20) 10						2	6	0	20	26	16

Total = 75

Master of Science in Cognitive Science

Department of Humanities and Social Sciences

The overall credits structure

Category	PC	PE	OC	Total
Credits	60	9	6	75

Program Core

HSL521	Introduction to Cognitive Science	3	0	2	4
HSS521	Independent Study in Cognitive Science (Bridge course)	0	2	0	2
HSL522	Basics of Programming for Cognitive Science	1	0	2	2
HSL541	Language in the Mind	3	1	0	4
HSL561	Cognitive Neuroscience	3	0	2	4
HSL621	Mathematical Foundations for Cognitive Science	2	1	0	3
HSL622	Computation and Cognition	3	0	2	4
HSL651	Philosophy of Mind and Cognition	3	1	0	4
HSL661	Cognitive Processes: From Labs to Fields	3	0	2	4
HSL721	Research Methods in Cognitive Science	1	0	4	3
HSL747	Language Computations and Mental Architecture	3	0	0	3
HSP700	Workshop on Scientific Writing	0	2	8	2
HSD621	Cognitive Science Project I	0	0	12	6
HSD622	Cognitive Science Project II	0	0	18	9
HSD623	Mini Project in Cognitive Science	0	0	4	2
HSP522	Cognitive Science Lecture Series I	0	0	4	2
HSP523	Cognitive Science Lecture Series II	0	0	4	2
Total Credits				60	

Program Electives

HSL726	Culture and Cognition	3	0	0	3
HSL727	Advances in Social Cognition	3	0	2	4
HSL767	Emotion and Decision making	3	0	0	3
HSL768	Judgment and Decision Making	3	0	0	3
HSL769	Number Cognition	3	0	2	4
HSL780	Social and Cultural Construction of Emotions	3	0	0	3
HSL722	Data Analysis for Behavioral Research using R	3	0	2	4
HSL723	Advanced Computational Methods	0.50	2	1.5	
HSL724	Advanced Experimental Methods	0.50	2	1.5	
HSL725	Advanced Qualitative Methods	0.50	2	1.5	
HSL748	Natural Language Understanding	3	0	0	3
HSL749	Optimality Theory and Harmonic Grammar	3	0	0	3
HSL821	Eye Movement and Cognitive Processes	2	0	2	3
HSL822	Advanced Data Analysis for Behavioral Research using R	3	0	2	4
HSL844	Computational Models of Meaning	3	0	0	3

Sem.	Courses (Number, Abbreviated Title, L-T-P, credits)						Lecture courses	Contact h/week				Credits
	L	T	P	Total								
I	Programme Core						5	11	3	10	24	19
	HSL521 Introduction to Cognitive Science (3-0-2) 4	HSS521 Independent Study in Cognitive Science (Bridge course) (0-2-0) 2	HSL522 Basics of Programming for Cognitive Science (1-0-2) 2	HSL541 Language in the Mind (3-1-0) 4	HSL561 Cognitive Neuroscience (3-0-2) 4	HSL721 Research Methods in Cognitive Science (1-0-4) 3						
II	Programme Core			Programme Elective			5	11	2	4	17	18
	HSL621 Mathematical Foundations for Cognitive Science (2-1-0) 3	HSL622 Computation and Cognition (3-0-2) 4	HSL651 Philosophy of Mind and Cognition (3-1-0) 4	HSL661 Cognitive Processes: From Labs to Fields (3-0-2) 4		PE-1 (3-0-0) 3						
Summer	HSD623 Mini Project in Cognitive Science (0-0-4) 2											
III	Programme Core				Open Elective	Programme Elective	3	9	2	16	27	19
	HSL747 Language Computations and Mental Architecture (3-0-0) 3	HSP522 Cognitive Science Lecture Series I (0-0-4) 2	HSP700 Workshop on Scientific Writing (0-2-0) 2	HSD621 Cognitive Science Project I (0-0-12) 6	OE-I (3-0-0) 3	PE-2 (3-0-0) 3						
IV	Programme Core				Open Elective	Programme Elective	2	6	0	22	28	17
	HSD622 Cognitive Science Project II (0-0-18) 9	HSP523 Cognitive Science Lecture II (0-0-4) 2			OE-II (3-0-0) 3	PE-3 (3-0-0) 3						

Total = 75

Master of Science in Economics
Department of Humanities and Social Sciences

The overall credits structure

Category	PC	PE	OC	Total
Credits	60	9	6	75

Program Core

HSL511	Microeconomics I	3	1	0	4
HSL512	Macroeconomics I	3	1	0	4
HSL513	Probability and Statistics for Economics	3	0	2	4
HSL516	Mathematical Economics	3	1	0	4
HSL514	Issues in Development	3	0	0	3
HSL611	Microeconomics II	3	1	0	4
HSL612	Macroeconomics II	3	1	0	4
HSL613	Econometrics	3	0	2	4
HSL614	Development Economics	3	0	0	3
HSL515	Indian Economy	3	0	0	3
HSP612	Research Seminar in Economics	1	0	4	3
HSP511	Economics Lab	0	0	8	4
HSP611	Advanced Economics Lab	0	0	8	4
HSP520	Research Project in Economics I	0	0	6	3
HSP620	Research Project in Economics II	0	0	18	9
Total Credits				60	

MTL725	Stochastic Processes and its Applications	3	0	0	3
MTL732	Financial Mathematics	3	0	0	3
MTL733	Stochastic of Finance	3	0	0	3
MTL766	Multivariate Statistical Methods	3	0	0	3
MTL843	Mathematical Modeling of Credit Risk	3	0	0	3
MTL505	Computer Programming	3	1	0	4
MTL508	Mathematical Programming	3	1	0	4
COL774	Machine Learning	3	0	2	4
ELL885	Machine Learning for Computational Finance	3	0	0	3
COL671	Principles of Artificial Intelligence	3	0	2	4

Development Economics Track

HSL818	Labour Economics	3	0	0	3
HSL817	Health Economics	3	0	0	3
HSL814	Research Methods in Economics	1	0	2	2
HSL717	Perspectives on Indian Economy	3	0	0	3
HSL718	Political Economy of Development	3	0	0	3
HSL775	Agrarian Societies and Rural Development	3	0	0	3
HSL874	Civil Society and Democracy in India	3	0	0	3
HSL878	Globalization	3	0	0	3
HSL783	Science, Technology and Society	3	0	0	3
HSL701	Introduction to Science and Technology Policy Studies	1.50	0	1.5	
HSL702	Approaches to Science and Technology Policy Studies	1.50	0	1.5	
HSL703	Perspectives on climate change: Implications for policy	3	0	0	3
HSL704	Inclusive Innovation: Theory and Practice	2	0	4	4
HSL762	Social Issues: Analysis and Policy	3	0	0	3
HSL772	Sociology of India	3	0	0	3
HSL776	Capitalism: Theory and Practice	3	0	0	3
HSL779	Gender and Society	3	0	0	3
HSL782	Perspectives on Development in India	3	0	0	3
HSL801	Law, Technology and Citizenship	3	0	0	3
HSL877	Industry and Society	3	0	0	3

Program Electives

Microeconomics Track

HSL816	Game Theory	3	0	0	3
HSL815	Theory of Market Design	3	0	0	3
HSL716	Industrial Economics	3	0	0	3
HSL813	Foundations of Decision Theory	3	0	0	3

Macroeconomics Track

HSL714	International Economics	3	0	0	3
HSL711	Macro Development Economics	3	0	0	3
HSL812	Advanced International Trade	3	0	0	3
HSL811	Advanced Economic Growth Theory	3	0	0	3

Quantitative Economics Track

HSL719	Advanced Econometrics	3	0	0	3
HSL715	Time Series Econometrics and Forecasting	3	0	0	3
MTL625	Principles of Optimization Theory	3	0	0	3

Sem.	Courses (Number, Abbreviated Title, L-T-P, credits)						Lecture courses	Contact h/week				Credits
	L	T	P	Total								
I	Programme Core						5	15	3	2	20	19
	HSL511 Microeconomics-1 (3-1-0) 4	HSL512 Macroeconomics-1 (3-1-0) 4	HSL513 Probability and Statistics for Economics (3-0-2) 4	HSL516 Mathematical Economics (3-1-0) 4	HSL514 Issues in Develop- ment* (3-0-0) 3							
II	Programme Core						5	15	2	10	27	22
	HSL611 Microeconomics-2 (3-1-0) 4	HSL612 Macroeconomics-2 (3-1-0) 4	HSL613 Econometrics (3-0-2) 4	HSL614 Development Economics (3-0-0) 3	HSP511 Economics Lab (0-0-8) 4	OE-1 (3-0-0) 3						
Summer	Summer Internship/Project (optional and non-credit)											
III	Programme Core				Programme Elective		5	13	0	18	31	22
	HSL515 Indian Economy* (3-0-0) 3	HSP612 Research Seminar (1-0-4) 3	HSP611 Advanced Economics Lab (0-0-8) 4	HSP520 Project I (0-0-6) 3	PE-1 (3-0-0) 3	PE-2 (3-0-0) 3						
IV	Programme Core				Programme Elective		1	3	0	18	21	12
	HSP620 Project II (0-0-18) 9				OE-2 (3-0-0) 3							

*Issues in Development and India Economy will be offered in alternate years so that both first year and second year students attend one compulsory course together.

Total = 75

Master of Science in Mathematics

Department of Mathematics

The overall credits structure

Category	PC	PE	OC	Total
Credits	57	12	6	75

Program Core

MTD701	Project-I	0	0	105
MTL501	Algebra	3	1	0 4
MTL502	Linear Algebra	3	1	0 4
MTL503	Real Analysis	3	1	0 4
MTL504	Ordinary Differential Equations	3	1	0 4
MTL505	Computer Programming	3	0	2 4
MTL506	Complex Analysis	3	1	0 4
MTL507	Topology	3	1	0 4
MTL508	Mathematical Programming	3	1	0 4
MTL509	Numerical Analysis	3	1	0 4
MTL510	Measure and Integration	3	1	0 4
MTL601	Probability and Statistics	3	1	0 4
MTL602	Functional Analysis	3	1	0 4
MTL603	Partial Differential Equations	3	1	0 4
Total Credits				57

Program Electives

MTD702	Project-II	0	0	126
MTL625	Principles of Optimization Theory	3	0	0 3
MTL704	Numerical Optimization	3	0	0 3
MTL712	Computational Methods for Differential Equations	3	0	2 4
MTL717	Fuzzy Sets and Applications	3	0	0 3
MTL720	Neurocomputing and Applications	3	0	0 3
MTL725	Stochastic Processes and its Applications	3	0	0 3
MTL728	Category Theory	3	0	0 3
MTL729	Computational Algebra and its Applications	3	0	0 3
MTL730	Cryptography	3	0	0 3
MTL731	Introduction to Chaotic Dynamical Systems	3	0	0 3
MTL732	Financial Mathematics	3	0	0 3
MTL733	Stochastic of Finance	3	0	0 3
MTL735	Advanced Number Theory	3	0	0 3
MTL737	Differential Geometry	3	0	0 3
MTL738	Commutative Algebra	3	0	0 3
MTL739	Representation of Finite Groups	3	0	0 3
MTL741	Fractal Geometry	3	0	0 3
MTL742	Operator Theory	3	0	0 3

MTL743	Fourier Analysis	3	0	0 3
MTL744	Mathematical Theory of Coding	3	0	0 3
MTL745	Advanced Matrix Theory	3	0	0 3
MTL746	Methods of Applied Mathematics	3	0	0 3
MTL747	Mathematical Logic	3	0	0 3
MTL751	Symbolic Dynamics	3	0	0 3
MTL755	Algebraic Geometry	3	0	0 3
MTL756	Lie Algebras and Lie Groups	3	0	0 3
MTL757	Introduction to Algebraic Topology	3	0	0 3
MTL760	Advanced Algorithms	3	0	0 3
MTL761	Basic Ergodic Theory	3	0	0 3
MTL762	Probability Theory	3	0	0 3
MTL763	Introduction to Game Theory	3	0	0 3
MTL766	Multivariate Statistical Methods	3	0	0 3
MTL768	Graph Theory	3	0	0 3
MTL773	Wavelets and Applications	3	0	0 3
MTL781	Finite Element Theory and Applications	3	0	0 3
MTL785	Natural Language Processing	3	0	0 3
MTL792	Modern Methods in Partial Differential equations	3	0	0 3
MTL793	Numerical Methods for Hyperbolic PDEs	3	0	0 3
MTL794	Advanced Probability Theory	3	0	0 3
MTL795	Numerical Method for Partial Differential Equations	3	1	0 4
MTL799	Mathematical Analysis in Learning Theory	3	0	0 3
MTV791	Special Module in Dynamical System	1	0	0 1
MTL843	Mathematical Modeling of Credit Risk	3	0	0 3
MTL851	Applied Numerical Analysis	3	0	0 3
MTL854	Interpolation and Approximation	3	0	0 3
MTL855	Multiple Decision Procedures in Ranking and Selection	3	0	0 3
MTL860	Linear Algebra	3	0	0 3
MTL863	Algebraic Number Theory	3	0	0 3
MTV874	Analysis	3	0	0 3
MTL882	Applied Analysis	3	0	0 3
MTL883	Physical Fluid Mechanics	3	0	0 3
MTL888	Boundary Elements Methods with Computer Implementation	3	0	0 3

Sem.	Courses (Number, Abbreviated Title, L-T-P, Credits)						Lecture courses	Contact h/week				Credits
	L	T	P	Total								
I	MTL501 Algebra (3-1-0) 4	MTL502 Linear Algebra (3-1-0) 4	MTL503 Real Analysis (3-1-0) 4	MTL504 Ordinary Differential Equations (3-1-0) 4	MTL505 Computer Programming (3-0-2) 4		5	15	5	0	20	20
II	MTL506 Complex Analysis (3-1-0) 4	MTL507 Topology (3-1-0) 4	MTL508 Mathematical Programming (3-1-0) 4	MTL509 Numerical Analysis (3-1-0) 4	MTL510 Measure and Integration (3-1-0) 4		5	15	5	0	20	20
Summer												
III	MTL601 Probability and Statistics (3-1-0) 4	MTL602 Functional Analysis (3-1-0) 4	MTL603 Partial Differential Equations (3-1-0) 4	DE-1	MAD701 Project-I (0-0-10) 5		4	12	3	10	25	20
IV	DE-2	DE-3	DE-4	OC-1	OC-2		5	15	0	0	15	15

Total = 75

Master of Science in Physics

Department of Physics

The overall credits structure

Category	PC	PE	OE	Total
Credits	62	12	6	80

Optional Departmental specialization : Additional 6 credits : Total Credits : 86 with specialization

Program Core

PYD561	Project-I	0	0	6	3
PYD562	Project-II	0	0	12	6
PYL551	Classical Mechanics	3	1	0	4
PYL552	Electrodynamics	3	1	0	4
PYL553	Mathematical Physics	3	1	0	4
PYL555	Quantum Mechanics-I	3	1	0	4
PYL556	Quantum Mechanics-II	3	0	0	3
PYL557	Electronics	3	1	0	4
PYL558	Statistical Mechanics	3	1	0	4
PYL560	Applied Optics	3	1	0	4
PYL563	Solid State Physics	3	1	0	4
PYL567	Atomic and Molecular Physics	3	0	0	3
PYL569	Nuclear and Particle Physics	3	0	0	3
PYP561	Laboratory-I	0	0	8	4
PYP562	Laboratory-II	0	0	8	4
PYP563	Advanced Laboratory	0	0	8	4
Total Credits				62	

PYL749	Quantum Information and Computation	3	0	0	3
PYL760	Biomedical optics and Bio-photonics	3	0	0	3
PYL761	Liquid Crystals	3	0	0	3
PYL762	Statistical Optics and Optical Coherence Theory	3	0	0	3
PYL770	Ultra-fast optics and applications	3	0	0	3
PYL793	Photonic Devices	3	0	0	3
PYL892	Guided Wave Photonic Sensors	3	0	0	3

Specialization in Condensed Matter Physics Min. 12 credits

PYL651	Advanced Solid State Physics	3	0	0	3
PYL652	Magnetism and Spintronics	3	0	0	3
PYL702	Physics of Semiconductor Devices	3	0	0	3
PYL704	Science and Technology of Thin Films	3	0	0	3
PYL707	Characterization Techniques for Materials	3	0	0	3
PYL727	Energy Materials and Devices	3	0	0	3
PYL728	Quantum Heterostructures	2	0	0	2
PYL739	Computational Techniques for Solid State Materials	3	0	0	3
PYL740	Advanced Condensed Matter Theory	3	0	0	3

Program Electives

PYD658	Mini Project	0	0	6	3
PYL653	Semiconductor Electronics	3	0	0	3
PYL656	Microwaves	3	0	0	3
PYL705	Nanostructured Materials	3	0	0	3
PYL723	Vacuum Science and Cryogenics	3	0	0	3
PYL725	Physics of Amorphous Materials	3	0	0	3
PYL792	Optical Electronics	3	0	0	3

Specialization in Theoretical Physics Min. 12 credits

PYL657	Plasma Physics	3	0	0	3
PYL658	Advanced Plasma Physics	3	0	0	3
PYL740	Advanced Condensed Matter Theory	3	0	0	3
PYL741	Field Theory and Quantum Electrodynamics	3	0	0	3
PYL742	General Relativity and Introductory Astrophysics	3	0	0	3
PYL743	Group Theory and its Applications	3	0	0	3
PYL744	High Energy Physics	3	0	0	3
PYL745	Advanced Statistical Mechanics	3	0	0	3
PYL746	Non-equilibrium Statistical Mechanics with Interdisciplinary Applications	3	0	0	3
PYL748	Quantum Optics	3	0	0	3
PYL749	Quantum Information and Computation	3	0	0	3

Specialization in Photonics Min. 12 credits

PYL650	Fiber and Integrated Optics	3	0	0	3
PYL655	Laser Physics	3	0	0	3
PYL659	Laser Spectroscopy	3	0	0	3
PYL747	Non-linear Optics	3	0	0	3
PYL748	Quantum Optics	3	0	0	3

Sem.	Courses (Number, Abbreviated Title, L-T-P, Credits)								Lecture courses	Contact h/week				Credits
	L	T	P	Total	L	T	P	Total						
I	PYL551 Classical Mechanics (3-1-0) 4	PYL553 Mathematical Physics (3-1-0) 4	PYL555 Quantum Mechanics (3-1-0) 4	PYL557 Electronics (3-1-0) 4	PYP561 Laboratory-I (0-0-8) 4				4	12	4	8	24	20
II	PYL552 Electrodynamics (3-1-0) 4	PYL556 Quantum Mechanics-II (3-0-0) 3	PYL558 Statistical Mechanics (3-1-0) 4	PYL560 Applied Optics (3-1-0) 4	PYP562 Laboratory-II (0-0-8) 4	PYL563 Solid State Physics (3-1-0) 4			5	15	3	8	26	22
Summer														
III	PYD561 Project-I (0-0-6) 3	PYL567 Atomic and Molecular Physics (3-0-0) 3	PYL569 Nuclear and Particle Physics (3-0-0) 3	PYP563 Advanced Laboratory (0-0-8) 4	PE-1 (3-0-0) 3	PE-2 (3-0-0) 3	OE-1 (3-0-0) 3	DS-1 (3-0-0) 3	5-6	15-18	1	14	30-33	23-26
IV	PYD562 Project-II (0-0-12) 6	PE-3 (3-0-0) 3	PE-4 (3-0-0) 3	OE-2 (3-0-0) 3	DS-2 (3-0-0) 3				3-4	9-12	0	12	21-24	15-18

Total = 75-81

Master of Design in Industrial Design

Department of Design

The overall credits structure

Category	PC	PE	OE	Total
Credits	39	9	3	51

Program Core

DSD792	Design Project-I	0	0	6	3
DSD891	Design Project-II	0	0	12	6
DSD892	Industry/ Research Design Project	0	0	18	9
DSL710	Framework of Design	2	0	0	2
DSL732	Adv. Mat. Processes & Die Design	2	0	2	3
DSL751	Form and Aesthetics	2	0	2	3
DSP711	Computer Aided Product Detailing	1	0	4	3
DSP721	Design and Innovation Methods	1	0	4	3
DSP722	Applied Ergonomics	1	0	2	2
DSP731	Communication and presentation skills	1	0	4	3
DSP741	Product Interface & Design	1	0	2	2
DSR761	Social Immersion (Non-credit)	0	0	2	0
DSR801	Summer Internship (Non-credit)	0	0	4	0
Total Credits				39	

Program Electives

DSL782	Design for Usability	2	0	2	3
DSL810	Special Topics in Design-I	3	0	0	3
DSL820	Special Topics in Design-II	3	0	0	3
DSL841	Design Management and Professional Practice	3	0	0	3
DSP712	Exhibitions and Environmental Design	2	0	2	3
DSR762	Vehicle Design	2	0	2	3
DSR772	Transportation Design	2	0	2	3
DSR812	Media Studies	2	0	2	3
DSR822	Design for Sustainability	2	0	2	3
DSR832	Design for User Experience	3	0	0	3
DSR852	Strategic Design Management	2	0	2	3
DSR862	Design in Indian Context	3	0	0	3
DSV820	Special Modules in Design	1	0	0	1

Sem.	Courses (Number, Abbreviated Title, L-T-P, Credits)						Lecture courses	Contact h/week				Credits
	L	T	P	Total								
I	DSL710 Framework of Design (2-0-0) 2	DSP721 Design and Innovation Methods (1-0-4) 3	DSP731 Communication and presentation skills (1-0-4) 3	DSP741 Product Interface & Design (1-0-2) 2	DSL751 Form and Aesthetics (2-0-2) 3		2	7	0	12	19	13
Winter	DSR761 Social Immersion (Non-credit core)											
II	DSP711 Computer Aided Product Detailing (1-0-4) 3	DSP722 Applied Ergonomics (1-0-2) 2	DSL732 Adv. Mat. Processes & Die Design (2-0-2) 3	DSD792 Design Project-I (0-0-6) 3	PE-1 (2-0-2/3-0-0) 3		2	6-7	0	14-16	21-22	14
Summer	DSR801 Summer Internship (Non-credit core)											
III	DSD891 Design Project-II (0-0-12) 6	PE-2 (2-0-2/3-0-0) 3	PE-3 (2-0-2/3-0-0) 3				2	4-6	0	6-10	12-14	12
IV	DSD892 Industry/ Research Design Project (0-0-18) 9	OE (3-0-0) 3					1	3	0	18	21	12

Total = 51

Master of Business Administration

Department of Management Studies

The overall credits structure

Category	Programme Core PC (Total 33 Credits)		Streamed Electives SE (Total 12 credits)		Non-credit Core NC	Programme Electives PE	Total
	Common Core CC	Unique Core UC	Analytical Skills Stream AS	People Skills Stream PS			
Credits	30	3	6	6	3	27	72

Program Core

Programme Core consists of Common Core (CC) courses and Unique Core (UC) courses. The total credits of Programme Core would be 33.

MSL705* HRM Systems	1.5	0	0	1.5
MSL706** Business Laws	3	0	0	3
MSL707* Management Accounting	3	0	0	3
MSL708* Financial Management	3	0	0	3
MSL709* Business Research Methods	1.5	0	0	1.5
MSL711* Strategic Management	3	0	0	3
MSL712* Ethics & Values Based Leadership	1.5	0	0	1.5
MSL713* Information Systems Management	3	0	0	3
MSL720* Macroeconomic Environment of Business	3	0	0	3
MSL745 Operations Management	3	0	0	3
MSL760 Marketing Management	3	0	0	3
MSL780* Managerial Economics	1.5	0	0	1.5
MSD890 MBA Project (Unique Core)	0	0	6	3

Notes:

The UC will include the MBA project which would focus on a research driven application of skills acquired in a particular functional area, through the programme.

* These are new courses which have been designed and/or modified as a part of the curriculum review.

** MSL706 was initially an elective, MSL887. This course's content is the same, only the number has been changed to now reflect a core course.

Total Credits 33

Streamed Electives (SE)

Streamed Electives consist of Analytical Skills (AS) Stream and People Skills (PS) Stream. The total credits of Streamed Electives would be 12 – 6 from AS and 6 from PS.

a) Analytical Skills (AS) Stream

MSL719* Statistics for Management	3	0	0	3
MSL721* Econometrics	3	0	0	3
MSL740 Quantitative Methods in Management	3	0	0	3
MTL732 Financial Mathematics	3	1	0	4

* These are new courses which have been designed and/or modified as a part of the curriculum review.

b) People Skills (PS) Stream

MSL710 Creative Problem Solving	3	0	0	3
MSL724* Business Communication	1.5	0	0	1.5
MSL725* Business Negotiations	1.5	0	0	1.5
MSL727* Interpersonal Behavior & Team Dynamics	1.5	0	0	1.5
MSL729* Individual Behavior in Organization	1.5	0	0	1.5
MSL730* Managing With Power	1.5	0	0	1.5
MSL731* Developing Self Awareness	1.5	0	0	1.5
MSL733* Organization Theory	1.5	0	0	1.5

* These are new courses which have been designed and/or modified as a part of the curriculum review.

Non-credit Core (NC)

MST893 Corporate Sector Attachment	0	0	4	2
MST894* Social Sector Attachment	0	0	2	1

* This is a new course which has been designed as a part of the curriculum review.

Program Electives (PE)

MDL800 Management of Blockchain Technologies	1.5	0	0	1.5
MSL716 Fundamentals of Management Systems	3	0	0	3
MSL717* Business Systems Analysis & Design	3	0	0	3
MSL811 Management Control Systems	3	0	0	3
MSL802 Management of Intellectual Property Rights	3	0	0	3

MSL835 Labor Legislation and Industrial Relations	3	0	0	3
MSL704 Science & Technology Policy Systems	3	0	0	3
MSL801 Technology Forecasting & Assessment	1	0	0	3
MSV801 Selected Topics in OB & HR Management	1	0	0	1
MSV802 Selected Topics in Finance	1	0	0	1
MSL803 Technical Entrepreneurship	3	0	0	3
MSV803 Selected Topics in Information Technology Mgmt.	1	0	0	1
MSV804 Selected Topics in Operations Management	1	0	0	1
MSV805 Selected Topics in Economics	1	0	0	1
MSL806* Mergers & Acquisitions	3	0	0	3
MSV806 Selected Topics in Marketing Management	1	0	0	1
MSL807* Selected Topics in Strategic Management	1	0	0	1
MSL808* Systems Thinking	3	0	0	3
MSL809* Cyber Security: Managing Risks	3	0	0	3
MSL810* Advanced Data Mining for Business Decisions	1.5	0	0	1.5
MSL812 Flexible Systems Management	3	0	0	3
MSL813 Systems Methodology for Management	3	0	0	3
MSL814* Data Visualization	1.5	0	0	1.5
MSL815 Decision Support and Expert Systems	3	0	0	3
MSL817 Systems Waste & Sustainability	3	0	0	3
MSL819 Business Process Re-engineering	3	0	0	3
MSL820 Global Business Environment	3	0	0	3
MSL821* Strategy Execution Excellence	3	0	0	3
MSL822 International Business	3	0	0	3
MSL823 Strategic Change & Flexibility	3	0	0	3
MSL824 Policy Dynamics & Learning Organization	3	0	0	3
MSL825 Strategies in Functional Management	3	0	0	3
MSL826 Business Ethics	3	0	0	3
MSL827 International Competitiveness	3	0	0	3
MSL828 Global Strategic Management	3	0	0	3
MSL829 Current & Emerging Issues in Strategic Management	3	0	0	3
MSL851* Strategic Alliance	1.5	0	0	1.5
MSL714 Organizational Dynamics and Environment	3	0	0	3
MSL830 Organizational Structure and Processes	3	0	0	3
MSL831 Management of Change	3	0	0	3
MSL832 Managing Innovation for Organizational Effectiveness	3	0	0	3
MSL833 Organizational Development	3	0	0	3
MSL834* Managing Diversity at Workplace	1.5	0	0	1.5
MSL836* International Human Resources Management	1.5	0	0	1.5
MSL839 Current & Emerging Issues in Organizational Management	3	0	0	3
MSL804* Procurement Management	3	0	0	3
MSL805* Services Operations Management	3	0	0	3
MSL715 Quality and Environment Management Systems	3	0	0	3
MSL816 Total Quality Management	3	0	0	3
MSL818 Industrial Waste Management	3	0	0	3
MSL840 Manufacturing Strategy	3	0	0	3
MSL841* Supply Chain Analytics	3	0	0	3
MSL842* Supply Chain Modeling	3	0	0	3
MSL843 Supply Chain Logistics Management	3	0	0	3
MSL844 Systems Reliability, Safety and Maintenance Management	3	0	0	3
MSL845 Total Project Systems Management	3	0	0	3
MSL846 Total Productivity Management	3	0	0	3
MSL848* Applied Operations Research	3	0	0	3
MSL849 Current & Emerging Issues in Manufacturing Management	3	0	0	3
MSL850 Management of Information Technology	3	0	0	3
MSL852 Network System: Applications and Mgmt.	3	0	0	3
MSL853* Software Project Management	3	0	0	3
MSL854* Big Data Analytics & Data Science	1.5	0	0	1.5
MSL855* Electronic Commerce	3	0	0	3
MSL856* Business Intelligence	3	0	0	3
MSL858* Business Process Management with IT	1.5	0	0	1.5

Courses of Study 2021-2022

MSL859	Current and Emerging Issues in IT Mgmt.	3	0	0	3	MSL898	Consultancy Professional Practice	3	0	0	3
MSL868*	Digital Research Methods	1.5	0	0	1.5	MSL899	Current & Emerging Issues in Consultancy Mgmt.	3	0	0	3
MSL876*	Economics of Digital Business	1.5	0	0	1.5	MSL895*	Advanced Data Analysis for Management	3	0	0	3
MSL877*	Electronic Government	1.5	0	0	1.5	MSL896*	International Economic Policy	3	0	0	3
MSL878*	Electronic Payments	1.5	0	0	1.5	MSV801*	Selected Topics in OB & HR Management	1	0	0	1
MSL882*	Enterprise Cloud Computing	1.5	0	0	1.5	MSV802*	Selected Topics in Finance	1	0	0	1
MSL883*	ICTs, Development and Business	1.5	0	0	1.5	MSV803*	Selected Topics in IT Management	1	0	0	1
MSL884*	Information System Strategy	3	0	0	3	MSV804*	Selected Topics in Operations Management	1	0	0	1
MSL885*	Digital Marketing-Analytics & Optimization	3	0	0	3	MSV805*	Selected Topics in Economics	1	0	0	1
MSL886*	IT Consulting & Practice	3	0	0	3	MSV806*	Selected Topics in Marketing Management	1	0	0	1
MSL887*	Mobile Commerce	3	0	0	3	MSV815*	Case Study Teaching and Writing	1	0	0	1
MSL888*	Data Warehousing for Business Decision	1.5	0	0	1.5	MSL799*	Theories in IS research	3	0	0	3
MSL891*	Data Analytics using SPSS	1.5	0	0	1.5	MSV816*	Contemporary Issue in Management	1	0	0	1
MSL892*	Predictive Analytics	1.5	0	0	1.5	MSV817*	Art of Scholarship in Management Research	1	0	0	1
MSL893*	Behavioral Finance	1.5	0	0	1.5	MSP801*	Interdisciplinary Research in Management	0	2	0	1
MSL894*	Financial Technology	1.5	0	0	1.5	MSV818*	Contemporary Issues in OB & HR Mgmt.	1	0	0	1
MSL861	Market Research	3	0	0	3	MSV819*	Contemporary Issues in Finance	1	0	0	1
MSL862	Product Management	3	0	0	3	MSV820*	Contemporary Issues in IT Management	1	0	0	1
MSL863	Advertising and Sales Promotion Management	3	0	0	3	MSV821*	Contemporary Issues in Operations Mgmt.	1	0	0	1
MSL864*	Corporate Communication	3	0	0	3	MSV822*	Contemporary Issues in Economic Policy	1	0	0	1
MSL865	Sales Management	3	0	0	3	MSV824*	Contemporary Issues in Strategic Mgmt.	1	0	0	1
MSL866	International Marketing	3	0	0	3	MSV826*	Frontiers in OB & HR Management	1	0	0	1
MSL867	Industrial Marketing Management	3	0	0	3	MSV827*	Frontiers in Finance	1	0	0	1
MSL869	Current & Emerging Issues in Marketing	3	0	0	3	MSV828*	Frontiers in Information Systems Mgmt.	1	0	0	1
MSL870*	Corporate Governance	1.5	0	0	1.5	MSV832*	Frontiers in Strategic Management	1	0	0	1
MSL871*	Banking and Financial Services	1.5	0	0	1.5	MSL735*	Qualitative Methods in Management	3	0	0	3
MSL872	Working Capital Management	3	0	0	3	MSL781*	Macroeconomic Dynamics	3	0	0	3
MSL873	Security Analysis & Portfolio Management	3	0	0	3	MSL837*	Entrepreneurial Finance	3	0	0	3
MSL874*	Indian Financial System	1.5	0	0	1.5	MSL750*	Behavioral Finance	1.5	0	0	1.5
MSL875	International Financial Management	3	0	0	3	MSL751*	Financial Technology	1.5	0	0	1.5
MSL879	Current & Emerging Issues in Finance	3	0	0	3	MSL860*	Derivatives	3	0	0	3
MSL734	Management of Small & Medium Scale Industrial Enterprises	3	0	0	3	MSL838*	Fixed Income Securities	3	0	0	3
MSL847	Advanced Methods for Management Research	3	0	0	3	MSL890*	Financial Engineering	3	0	0	3
MSL880	Selected Topics in Management Methodology	3	0	0	3	MSL310*	Financial Institutions and Markets	3	0	0	3
MSL881	Mgmt. of Public Sector Enterprises in India	3	0	0	3	MSL718*	Management of Blockchain Technology	1.5	0	0	1.5
MSL889	Current & Emerging Issues in Public Sector Mgmt.	3	0	0	3	MSL722*	Managing Enterprise AI/ML Systems	1.5	0	0	1.5
MSL897	Consultancy Process & Skills	3	0	0	3	MSL782*	Business Cycles and Global Economy	1.5	0	0	1.5
						MSL783*	Global Economic Development	1.5	0	0	1.5
						MSL784*	Sovereign Debt and Default	3	0	0	3

* These are new courses which have been designed and/or modified

Sem.	Courses (Number, Abbreviated Title, L-T-P, Credits)									Lecture courses	Contact h/week				Credits	
	L	T	P	Total												
I	MSL707 Mgmt. Accounting (3-0-0) 3	MSL709 Business Research Methods (1.5-0-0) 1.5	MSL712 Ethics & Values Based Leadership (1.5-0-0) 1.5	MSL760 Marketing Mgmt. (3-0-0) 3	MSL780 Managerial Economics (1.5-0-0) 1.5	SE AS-1 (3-0-0) 3	SE AS-2 (3-0-0) 3	SE PS-1 (1.5-0-0) 1.5	SE PS-2 (1.5-0-0) 1.5	9	19.5	0	0	19.5	19.5	
Winter	MST894 Social Sector Attachment															
II	MSL705 HRM Systems (1.5-0-0) 1.5	MSL708 Financial Mgmt. (3-0-0) 3	MSL711 Strategic Mgmt. (3-0-0) 3	MSL713 Infor- mation Systems Mgmt. (3-0-0) 3	MSL720 Macroeco- nomic Environ- ment of Business (3-0-0) 3	MSL745 Operations Mgmt. (3-0-0) 3	SE PS-3 (1.5-0-0) 1.5	SE PS-4 (1.5-0-0) 1.5	SE PS-5 (3-0-0) 3	7/8	19.5	0	0	19.5	19.5	
Summer	MST893 Corporate Sector Attachment															
III	PE (Credits 15-18)									6/7	15-18	0	0	15-18	15-18	
IV	MSD890 MBA Project (0-0-6) 3	MSL706 Business Laws (3-0-0) 3	PE (Credits 9-12)								4/6	12-15	0	6	18-21	15-18

SE = Streamed Electives, AS = Analytical Skills Stream, PS = People Skills Stream, PE = Programme Electives

Total = 72

Master of Business Administration (Telecommunication Systems Management)

Department of Management Studies

The overall credits structure

Category	Programme Core PC (Total 33 Credits)		Streamed Electives SE (Total 12 credits)		Focus Electives FE	Non-credit Core NC	Programme Electives PE	Total
	Common Core CC	Unique Core UC	Analytical Skills Stream AS	People Skills Stream PS				
Credits	30	3	6	6	6	3	21	72

Program Core (PC)

Programme Core consists of Common Core (CC) courses and Unique Core (UC) courses. The total credits of Programme Core would be 33.

MSL705* HRM Systems	1.5	0	0	1.5
MSL706** Business Laws	3	0	0	3
MSL707* Management Accounting	3	0	0	3
MSL708* Financial Management	3	0	0	3
MSL709* Business Research Methods	1.5	0	0	1.5
MSL711* Strategic Management	3	0	0	3
MSL712* Ethics & Values Based Leadership	1.5	0	0	1.5
MSL713* Information Systems Management	3	0	0	3
MSL720* Macroeconomic Environment of Business	3	0	0	3
MSL745 Operations Management	3	0	0	3
MSL760 Marketing Management	3	0	0	3
MSL780* Managerial Economics	1.5	0	0	1.5
MSD891 MBA Project (Unique Core)	0	0	6	3

Notes:

The UC will include the MBA project which would focus on a research driven application of skills acquired in a particular functional area, through the programme.

* These are new courses which have been designed and/or modified as a part of the curriculum review.

** MSL706 was initially an elective, MSL887. This course's content is the same, only the number has been changed to now reflect a core course.

Total Credits 33

Streamed Electives (SE)

Streamed Electives consist of Analytical Skills (AS) Stream and People Skills (PS) Stream. The total credits of Streamed Electives would be 12 – 6 from AS and 6 from PS.

a) Analytical Skills (AS) Stream

MSL719* Statistics for Management	3	0	0	3
MSL721* Econometrics	3	0	0	3
MSL740 Quantitative Methods in Management	3	0	0	3
MTL732 Financial Mathematics	3	1	0	4

* These are new courses which have been designed and/or modified as a part of the curriculum review.

b) People Skills (PS) Stream

MSL710 Creative Problem Solving	3	0	0	3
MSL724* Business Communication	1.5	0	0	1.5
MSL725* Business Negotiations	1.5	0	0	1.5
MSL727* Interpersonal Behavior & Team Dynamics	1.5	0	0	1.5
MSL729* Individual Behavior in Organization	1.5	0	0	1.5
MSL730* Managing With Power	1.5	0	0	1.5
MSL731* Developing Self Awareness	1.5	0	0	1.5
MSL733* Organization Theory	1.5	0	0	1.5

* These are new courses which have been designed and/or modified as a part of the curriculum review.

Focus Electives (FE)

MSL723 Telecommunication Systems	3	0	0	3
MSL726 Telecom System Analysis, Planning & Design	3	0	0	3
MSL728 International Telecommunication Management	3	0	0	3
EEL767 Telecom Systems	3	0	0	3

Non-credit Core (NC)

MST893 Corporate Sector Attachment	0	0	4	2
MST894* Social Sector Attachment	0	0	2	1

* This is a new course which has been designed as a part of the curriculum review.

Program Electives (PE)

MDL800 Management of Blockchain Technologies	1.5	0	0	1.5
MSL716 Fundamentals of Management Systems	3	0	0	3
MSL717* Business Systems Analysis & Design	3	0	0	3
MSL811 Management Control Systems	3	0	0	3
MSL802 Management of Intellectual Property Rights	3	0	0	3
MSL835 Labor Legislation and Industrial Relations	3	0	0	3
MSL704 Science & Technology Policy Systems	3	0	0	3
MSL801 Technology Forecasting & Assessment	3	0	0	3
MSL803 Technical Entrepreneurship	3	0	0	3
MSL806* Mergers & Acquisitions	3	0	0	3
MSL807* Selected Topics in Strategic Management	1	0	0	1
MSL808* Systems Thinking	3	0	0	3
MSL812 Flexible Systems Management	3	0	0	3
MSL813 Systems Methodology for Management	3	0	0	3
MSL817 Systems Waste & Sustainability	3	0	0	3
MSL819 Business Process Re-engineering	3	0	0	3
MSL820 Global Business Environment	3	0	0	3
MSL821* Strategy Execution Excellence	3	0	0	3
MSL822 International Business	3	0	0	3
MSL823 Strategic Change & Flexibility	3	0	0	3
MSL824 Policy Dynamics & Learning Organization	3	0	0	3
MSL825 Strategies in Functional Management	3	0	0	3
MSL826 Business Ethics	3	0	0	3
MSL827 International Competitiveness	3	0	0	3
MSL828 Global Strategic Management	3	0	0	3
MSL829 Current & Emerging Issues in Strategic Mgmt.	3	0	0	3
MSL851* Strategic Alliance	1.5	0	0	1.5
MSL714 Organizational Dynamics and Environment	3	0	0	3
MSL809* Cyber Security: Managing Risks	3	0	0	3
MSL810* Advanced Data Mining for Business Decisions	1.5	0	0	1.5
MSL814* Data Visualization	1.5	0	0	1.5
MSL815 Decision Support and Expert Systems	3	0	0	3
MSL830 Organizational Structure and Processes	3	0	0	3
MSL831 Management of Change	3	0	0	3
MSL832 Managing Innovation for Organizational Effectiveness	3	0	0	3
MSL833 Organizational Development	3	0	0	3
MSL834* Managing Diversity at Workplace	1.5	0	0	1.5
MSL836* International Human Resources Management	1.5	0	0	1.5
MSL839 Current & Emerging Issues in Organizational Management	3	0	0	3
MSL804* Procurement Management	3	0	0	3
MSL805* Services Operations Management	3	0	0	3
MSL715 Quality and Environment Management Systems	3	0	0	3
MSL816 Total Quality Management	3	0	0	3
MSL818 Industrial Waste Management	3	0	0	3
MSL840 Manufacturing Strategy	3	0	0	3
MSL841* Supply Chain Analytics	3	0	0	3
MSL842* Supply Chain Modeling	3	0	0	3
MSL843 Supply Chain Logistics Management	3	0	0	3
MSL844 Systems Reliability, Safety and Maintenance Management	3	0	0	3
MSL845 Total Project Systems Management	3	0	0	3
MSL846 Total Productivity Management	3	0	0	3
MSL848* Applied Operations Research	3	0	0	3
MSL849 Current & Emerging Issues in Manufacturing Management	3	0	0	3
MSL850 Management of Information Technology	3	0	0	3
MSL852 Network System: Applications and Management	3	0	0	3
MSL853* Software Project Management	3	0	0	3
MSL854* Big Data Analytics & Data Science	1.5	0	0	1.5
MSL855* Electronic Commerce	3	0	0	3
MSL856* Business Intelligence	3	0	0	3
MSL858* Business Process Management with IT	1.5	0	0	1.5

Courses of Study 2021-2022

MSL859	Current and Emerging Issues in IT Mgmt.	3	0	0	3	MSL895*	Advanced Data Analysis for Management	3	0	0	3
MSL868*	Digital Research Methods	1.5	0	0	1.5	MSL896*	International Economic Policy	3	0	0	3
MSL876*	Economics of Digital Business	1.5	0	0	1.5	MSV801*	Selected Topics in OB & HR Management	1	0	0	1
MSL877*	Electronic Government	1.5	0	0	1.5	MSV802*	Selected Topics in Finance	1	0	0	1
MSL878*	Electronic Payments	1.5	0	0	1.5	MSV803*	Selected Topics in IT Management	1	0	0	1
MSL882*	Enterprise Cloud Computing	1.5	0	0	1.5	MSV804*	Selected Topics in Operations Management	1	0	0	1
MSL883*	ICTs, Development and Business	1.5	0	0	1.5	MSV805*	Selected Topics in Economics	1	0	0	1
MSL884*	Information System Strategy	3	0	0	3	MSV806*	Selected Topics in Marketing Management	1	0	0	1
MSL885*	Digital Marketing-Analytics & Optimization	3	0	0	3	MSV815*	Case Study Teaching and Writing	1	0	0	1
MSL886*	IT Consulting & Practice	3	0	0	3	MSL799*	Theories in IS research	3	0	0	3
MSL887*	Mobile Commerce	3	0	0	3	MSV816*	Contemporary Issue in Management	1	0	0	1
MSL888*	Data Warehousing for Business Decision	1.5	0	0	1.5	MSV817*	Art of Scholarship in Management Research	1	0	0	1
MSL891*	Data Analytics using SPSS	1.5	0	0	1.5	MSP801*	Interdisciplinary Research in Management	0	2	1	
MSL892*	Predictive Analytics	1.5	0	0	1.5	MSV818*	Contemporary Issues in OB & HR Mgmt.	1	0	0	1
MSL861	Market Research	3	0	0	3	MSV819*	Contemporary Issues in Finance	1	0	0	1
MSL862	Product Management	3	0	0	3	MSV820*	Contemporary Issues in IT Management	1	0	0	1
MSL863	Advertising and Sales Promotion Management	3	0	0	3	MSV821*	Contemporary Issues in Operations Mgmt.	1	0	0	1
MSL864*	Corporate Communication	3	0	0	3	MSV822*	Contemporary Issues in Economic Policy	1	0	0	1
MSL865	Sales Management	3	0	0	3	MSV824*	Contemporary Issues in Strategic Mgmt.	1	0	0	1
MSL866	International Marketing	3	0	0	3	MSV826*	Frontiers in OB & HR Management	1	0	0	1
MSL867	Industrial Marketing Management	3	0	0	3	MSV827*	Frontiers in Finance	1	0	0	1
MSL869	Current & Emerging Issues in Marketing	3	0	0	3	MSV828*	Frontiers in Information Systems Mgmt.	1	0	0	1
MSL870*	Corporate Governance	1.5	0	0	1.5	MSV832*	Frontiers in Strategic Management	1	0	0	1
MSL871*	Banking and Financial Services	1.5	0	0	1.5	MSL735*	Qualitative Methods in Management	3	0	0	3
MSL872	Working Capital Management	3	0	0	3	MSL781*	Macroeconomic Dynamics	3	0	0	3
MSL873	Security Analysis & Portfolio Management	3	0	0	3	MSL750*	Behavioral Finance	1.5	0	0	1.5
MSL874*	Indian Financial System	1.5	0	0	1.5	MSL751*	Financial Technology	1.5	0	0	1.5
MSL875	International Financial Management	3	0	0	3	MSL860*	Derivatives	3	0	0	3
MSL879	Current & Emerging Issues in Finance	3	0	0	3	MSL838*	Fixed Income Securities	3	0	0	3
MSL734	Management of Small & Medium Scale Industrial Enterprises	3	0	0	3	MSL890*	Financial Engineering	3	0	0	3
MSL847	Advanced Methods for Management Research	3	0	0	3	MSL893*	Behavioral Finance	1.5	0	0	1.5
MSL880	Selected Topics in Management Methodology	3	0	0	3	MSL894*	Financial Technology	1.5	0	0	1.5
MSL881	Mgmt. of Public Sector Enterprises in India	3	0	0	3	MSL310*	Financial Institutions and Markets	3	0	0	3
MSL889	Current & Emerging Issues in Public Sector Mgmt.	3	0	0	3	MSL718*	Management of Blockchain Technology	1.5	0	0	1.5
MSL897	Consultancy Process & Skills	3	0	0	3	MSL722*	Managing Enterprise AI/ML Systems	1.5	0	0	1.5
MSL898	Consultancy Professional Practice	3	0	0	3	MSL782*	Business Cycles and Global Economy	1.5	0	0	1.5
MSL899	Current & Emerging Issues in Consultancy Management	3	0	0	3	MSL783*	Global Economic Development	1.5	0	0	1.5
						MSL784*	Sovereign Debt and Default	3	0	0	3

* These are new courses which have been designed and/or modified as a part of the curriculum review.

Sem.	Courses (Number, Abbreviated Title, L-T-P, credits)									Lecture courses	Contact h/week				Credits
	L	T	P	Total											
I	MSL707 Mgmt. Accounting (3-0-0) 3	MSL709 Business Research Methods (1.5-0-0) 1.5	MSL712 Ethics & Values Based Leadership (1.5-0-0) 1.5	MSL760 Marketing Mgmt. (3-0-0) 3	MSL780 Managerial Economics (1.5-0-0) 1.5	SE AS-1 (3-0-0) 3	SE AS-2 (3-0-0) 3	SE PS-1 (1.5-0-0) 1.5	SE PS-2 (1.5-0-0) 1.5	9	19.5	0	0	19.5	19.5
Winter	MST894 Social Sector Attachment														
II	MSL705 HRM Systems (1.5-0-0) 1.5	MSL708 Financial Mgmt. (3-0-0) 3	MSL711 Strategic Mgmt. (3-0-0) 3	MSL713 Information Systems Mgmt. (3-0-0) 3	MSL720 Macroeconomic Environment of Business (3-0-0) 3	MSL745 Operations Mgmt. (3-0-0) 3	SE PS-3 (1.5-0-0) 1.5	SE PS-4 (1.5-0-0) 1.5	SE PS-5 (3-0-0) 3	7/8	19.5	0	0	19.5	19.5
Summer	MST893 Corporate Sector Attachment														
III	PE (Credits 15-18)									6/7	15-18	0	0	15-18	15-18
IV	MSD891 MBA Project (0-0-6) 3	MSL706 Business Laws (3-0-0) 3	FE-1 (3-0-0) 3	FE-2 (3-0-0) 3	PE (Credits 3-6)					4/6	12-15	0	6	18-21	15-18

SE = Streamed Electives, AS = Analytical Skills Stream, PS = People Skills Stream, PE = Programme Electives

Total = 72

Master of Business Administration (Technology Management)

Department of Management Studies

The overall credits structure

Category	Programme Core PC (Total 33 Credits)		Streamed Electives SE (Total 12 credits)		Focus Electives FE 6	Non-credit Core NC 3	Programme Electives PE 21	Total 72
	Common Core CC 30	Unique Core UC 3	Analytical Skills Stream AS 6	People Skills Stream PS 6				

Program Core (PC)

Programme Core consists of Common Core (CC) courses and Unique Core (UC) courses. The total credits of Programme Core would be 33.

MSL705* HRM Systems	1.5	0	0	1.5
MSL706** Business Laws	3	0	0	3
MSL707* Management Accounting	3	0	0	3
MSL708* Financial Management	3	0	0	3
MSL709* Business Research Methods	1.5	0	0	1.5
MSL711* Strategic Management	3	0	0	3
MSL712* Ethics & Values Based Leadership	1.5	0	0	1.5
MSL713* Information Systems Management	3	0	0	3
MSL720* Macroeconomic Environment of Business	3	0	0	3
MSL745 Operations Management	3	0	0	3
MSL760 Marketing Management	3	0	0	3
MSL780* Managerial Economics	1.5	0	0	1.5
MSD892 MBA Project (Unique Core)	0	0	6	3

Notes:

The UC will include MBA project which would focus on a research driven application of skills acquired in a particular functional area, through the programme.

* These are new courses which have been designed and/or modified as a part of the curriculum review.

** MSL706 was initially an elective, MSL887. This course's content is the same, only the number has been changed to now reflect a core course.

Total Credits 33

Streamed Electives (SE)

Streamed Electives consist of Analytical Skills (AS) Stream and People Skills (PS) Stream. The total credits of Streamed Electives would be 12 – 6 from AS and 6 from PS.

a) Analytical Skills (AS) Stream

MSL719* Statistics for Management	3	0	0	3
MSL721* Econometrics	3	0	0	3
MSL740 Quantitative Methods in Management	3	0	0	3
MTL732 Financial Mathematics	3	1	0	4

* These are new courses which have been designed and/or modified as a part of the curriculum review.

b) People Skills (PS) Stream

MSL710 Creative Problem Solving	3	0	0	3
MSL724* Business Communication	1.5	0	0	1.5
MSL725* Business Negotiations	1.5	0	0	1.5
MSL727* Interpersonal Behavior & Team Dynamics	1.5	0	0	1.5
MSL729* Individual Behavior in Organization	1.5	0	0	1.5
MSL730* Managing With Power	1.5	0	0	1.5
MSL731* Developing Self Awareness	1.5	0	0	1.5
MSL733* Organization Theory	1.5	0	0	1.5

* These are new courses which have been designed and/or modified as a part of the curriculum review.

Focus Electives (FE)

MSL700 Fundamentals of Management of Technology	3	0	0	3
MSL701 Strategic Technology Management	3	0	0	3
MSL702 Management of Innovation and R&D	3	0	0	3
MSL703 Mgmt. of Technology Transfer and Absorption	3	0	0	3

Non-credit Core (NC)

MSC894* Seminar	0	0	6	3
-----------------	---	---	---	---

* This is a new course which has been designed as a part of the curriculum review.

Program Electives (PE)

MDL800 Management of Blockchain Technologies	1.5	0	0	1.5
MSL716 Fundamentals of Management Systems	3	0	0	3
MSL717* Business Systems Analysis & Design	3	0	0	3
MSL811 Management Control Systems	3	0	0	3
MSL802 Management of Intellectual Property Rights	3	0	0	3
MSL835 Labor Legislation and Industrial Relations	3	0	0	3
MSL704 Science & Technology Policy Systems	3	0	0	3
MSL801 Technology Forecasting & Assessment	3	0	0	3
MSL803 Technical Entrepreneurship	3	0	0	3
MSL806* Mergers & Acquisitions	3	0	0	3
MSL807* Selected Topics in Strategic Management	1	0	0	1
MSL808* Systems Thinking	3	0	0	3
MSL812 Flexible Systems Management	3	0	0	3
MSL813 Systems Methodology for Management	3	0	0	3
MSL817 Systems Waste & Sustainability	3	0	0	3
MSL819 Business Process Re-engineering	3	0	0	3
MSL820 Global Business Environment	3	0	0	3
MSL821* Strategy Execution Excellence	3	0	0	3
MSL822 International Business	3	0	0	3
MSL823 Strategic Change & Flexibility	3	0	0	3
MSL824 Policy Dynamics & Learning Organization	3	0	0	3
MSL825 Strategies in Functional Management	3	0	0	3
MSL826 Business Ethics	3	0	0	3
MSL827 International Competitiveness	3	0	0	3
MSL828 Global Strategic Management	3	0	0	3
MSL829 Current & Emerging Issues in Strategic Mgmt.	3	0	0	3
MSL851* Strategic Alliance	1.5	0	0	1.5
MSL714 Organizational Dynamics and Environment	3	0	0	3
MSL830 Organizational Structure and Processes	3	0	0	3
MSL831 Management of Change	3	0	0	3
MSL832 Managing Innovation for Organizational Effectiveness	3	0	0	3
MSL833 Organizational Development	3	0	0	3
MSL834* Managing Diversity at Workplace	1.5	0	0	1.5
MSL836* International Human Resources Management	1.5	0	0	1.5
MSL839 Current & Emerging Issues in Organizational Management	3	0	0	3
MSL804* Procurement Management	3	0	0	3
MSL805* Services Operations Management	3	0	0	3
MSL715 Quality and Environment Management Systems	3	0	0	3
MSL814* Data Visualization	1.5	0	0	1.5
MSL815 Decision Support and Expert Systems	3	0	0	3
MSL816 Total Quality Management	3	0	0	3
MSL818 Industrial Waste Management	3	0	0	3
MSL840 Manufacturing Strategy	3	0	0	3
MSL841* Supply Chain Analytics	3	0	0	3
MSL842* Supply Chain Modeling	3	0	0	3
MSL843 Supply Chain Logistics Management	3	0	0	3
MSL844 Systems Reliability, Safety and Maintenance Mgmt.	3	0	0	3
MSL845 Total Project Systems Management	3	0	0	3
MSL846 Total Productivity Management	3	0	0	3
MSL848* Applied Operations Research	3	0	0	3
MSL849 Current & Emerging Issues in Manufacturing Mgmt.	3	0	0	3
MSL809* Cyber Security: Managing Risks	3	0	0	3
MSL810* Advanced Data Mining for Business Decisions	1.5	0	0	1.5
MSL850 Management of Information Technology	3	0	0	3
MSL852 Network System: Applications and Mgmt.	3	0	0	3
MSL853* Software Project Management	3	0	0	3
MSL854* Big Data Analytics & Data Science	1.5	0	0	1.5
MSL855* Electronic Commerce	3	0	0	3
MSL856* Business Intelligence	3	0	0	3
MSL858* Business Process Management with IT	1.5	0	0	1.5

Courses of Study 2021-2022

MSL859	Current and Emerging Issues in IT Mgmt.	3	0	0	3	MSL899	Current & Emerging Issues in Consultancy Mgmt.	3	0	0	3
MSL868*	Digital Research Methods	1.5	0	0	1.5	MSL895*	Advanced Data Analysis for Management	3	0	0	3
MSL876*	Economics of Digital Business	1.5	0	0	1.5	MSL896*	International Economic Policy	3	0	0	3
MSL877*	Electronic Government	1.5	0	0	1.5	MSV801*	Selected Topics in OB & HR Management	1	0	0	1
MSL878*	Electronic Payments	1.5	0	0	1.5	MSV802*	Selected Topics in Finance	1	0	0	1
MSL882*	Enterprise Cloud Computing	1.5	0	0	1.5	MSV803*	Selected Topics in IT Management	1	0	0	1
MSL883*	ICTs, Development and Business	1.5	0	0	1.5	MSV804*	Selected Topics in Operations Management	1	0	0	1
MSL884*	Information System Strategy	3	0	0	3	MSV805*	Selected Topics in Economics	1	0	0	1
MSL885*	Digital Marketing-Analytics & Optimization	3	0	0	3	MSV806*	Selected Topics in Marketing Management	1	0	0	1
MSL886*	IT Consulting & Practice	3	0	0	3	MSV815*	Case Study Teaching and Writing	1	0	0	1
MSL887*	Mobile Commerce	3	0	0	3	MSL799*	Theories in IS research	3	0	0	3
MSL888*	Data Warehousing for Business Decision	1.5	0	0	1.5	MSV816*	Contemporary Issue in Management	1	0	0	1
MSL891*	Data Analytics using SPSS	1.5	0	0	1.5	MSV817*	Art of Scholarship in Management Research	1	0	0	1
MSL892*	Predictive Analytics	1.5	0	0	1.5	MSP801*	Interdisciplinary Research in Management	0	0	2	1
MSL893*	Behavioral Finance	1.5	0	0	1.5	MSV818*	Contemporary Issues in OB & HR Mgmt.	1	0	0	1
MSL894*	Social Media & Business Practices	3	0	0	3	MSV819*	Contemporary Issues in Finance	1	0	0	1
MSL861	Market Research	3	0	0	3	MSV820*	Contemporary Issues in IT Management	1	0	0	1
MSL862	Product Management	3	0	0	3	MSV821*	Contemporary Issues in Operations Mgmt.	1	0	0	1
MSL863	Advertising and Sales Promotion Management	3	0	0	3	MSV822*	Contemporary Issues in Economic Policy	1	0	0	1
MSL864*	Corporate Communication	3	0	0	3	MSV824*	Contemporary Issues in Strategic Mgmt.	1	0	0	1
MSL865	Sales Management	3	0	0	3	MSV826*	Frontiers in OB & HR Management	1	0	0	1
MSL866	International Marketing	3	0	0	3	MSV827*	Frontiers in Finance	1	0	0	1
MSL867	Industrial Marketing Management	3	0	0	3	MSV828*	Frontiers in Information Systems Mgmt.	1	0	0	1
MSL869	Current & Emerging Issues in Marketing	3	0	0	3	MSV832*	Frontiers in Strategic Management	1	0	0	1
MSL870*	Corporate Governance	1.5	0	0	1.5	MSL735*	Qualitative Methods in Management	3	0	0	3
MSL871*	Banking and Financial Services	1.5	0	0	1.5	MSL781*	Macroeconomic Dynamics	3	0	0	3
MSL872	Working Capital Management	3	0	0	3	MSL837*	Entrepreneurial Finance	3	0	0	3
MSL873	Security Analysis & Portfolio Management	3	0	0	3	MSL750*	Behavioral Finance	1.5	0	0	1.5
MSL874*	Indian Financial System	1.5	0	0	1.5	MSL751*	Financial Technology	1.5	0	0	1.5
MSL875	International Financial Management	3	0	0	3	MSL860*	Derivatives	3	0	0	3
MSL879	Current & Emerging Issues in Finance	3	0	0	3	MSL838*	Fixed Income Securities	3	0	0	3
MSL734	Management of Small & Medium Scale Industrial Enterprises	3	0	0	3	MSL890*	Financial Engineering	3	0	0	3
MSL847	Advanced Methods for Management Research	3	0	0	3	MSL310*	Financial Institutions and Markets	3	0	0	3
MSL880	Selected Topics in Management Methodology	3	0	0	3	MSL718*	Management of Blockchain Technology	1.5	0	0	1.5
MSL881	Mgmt. of Public Sector Enterprises in India	3	0	0	3	MSL722*	Managing Enterprise AI/ML Systems	1.5	0	0	1.5
MSL889	Current & Emerging Issues in Public Sector Mgmt.	3	0	0	3	MSL782*	Business Cycles and Global Economy	1.5	0	0	1.5
MSL894	Financial Technology	1.5	0	0	1.5	MSL783*	Global Economic Development	1.5	0	0	1.5
MSL897	Consultancy Process & Skills	3	0	0	3	MSL784*	Sovereign Debt and Default	3	0	0	3
MSL898	Consultancy Professional Practice	3	0	0	3						

* These are new courses which have been designed and/or modified as a part of the curriculum review.

Sem.	Courses (Number, Abbreviated Title, L-T-P, credits)					Lecture courses	Contact h/week				Credits
	L	T	P	Total							
I	MSL707 Mgmt. Accounting (3-0-0) 3	MSL709 Business Research Methods (1.5-0-0) 1.5	MSL712 Ethics & Values Based Leadership (1.5-0-0) 1.5	MSL760 Marketing Mgmt. (3-0-0) 3	SE AS-1 (3-0-0) 3	5	12	0	0	12	12
II	MSL705 HRM Systems (1.5-0-0) 1.5	MSL708 Financial Mgmt. (3-0-0) 3	MSL713 Information Sys- tems Mgmt. (3-0-0) 3	MSL780 Managerial Economics (1.5-0-0) 1.5	SE AS-2 (3-0-0) 3	5	12	0	0	12	12
III	MSL711 Strategic Mgmt. (3-0-0) 3	MSL720 Macroeconomic Environment of Business (3-0-0) 3	MSL745 Operations Mgmt. (3-0-0) 3	SE PS-1 (1.5-0-0) 1.5 SE PS-5 (3-0-0) 3	SE PS-2 (1.5-0-0) 1.5	5	12	0	0	12	12
IV	SE PS-3 (1.5-0-0) 1.5		SE PS-4 (1.5-0-0) 1.5	FE-1 (3-0-0) 3	PE (Credits 6)	5	12	0	0	12	12
Summer	MSC894 Seminar										
V	MSL706 Business Laws (3-0-0) 3	FE-2 (3-0-0) 3		PE (Credits 6)		4/5	12	0	0	12	12
VI	MSD892 MBA Project (0-0-6) 3			PE (Credits 9)		3/4	9	0	6	15	12

SE = Streamed Electives, AS = Analytical Skills Stream, PS = People Skills Stream, PE = Programme Electives, FE= Focus Elective

Total = 72

Master of Technology in Engineering Analysis and Design

Department of Applied Mechanics

The overall credits structure

Category	PC	PE	OC	Total
Credits	34	12	6	52

Program Core (PC)

APL701	Continuum Mechanics	3	0	0	3
APL702	Experimental Methods for Solids and Fluids	2	0	2	3
APL703	Engineering Mathematic and Computation	3	0	2	4
APL734	Advanced Dynamics	3	0	0	3
APL775	Design Methods	3	0	0	3

Product Design (Program Electives)

APL710	Computer Aided Design	3	0	2	4
APL737	Advanced Design of Machine Elements	3	0	0	3
APL767	Engineering Failure Analysis and Prevention	3	0	0	3
APL771	Design Optimization and Decision Theory	3	0	0	3
APL774	Modeling & Analysis of Mechanical Systems	3	0	0	3
APL776	Product Design and Feasibility Study (Stream Core)	2	0	4	4
APL871	Product Reliability	3	0	0	3
MCL741	Control Engineering	3	0	2	4
MCL749	Mechatronics Product Design	3	0	2	4

Engineering Mechanics (Program Electives)

APL705	Finite Element Method	3	0	2	4
APL711	Advanced Fluid Mechanics	3	0	0	3

APL713	Turbulence and its Modeling	3	0	0	3
APL715	Physics of Turbulent Flows	3	0	0	3
APL716	Fluid Transportation Systems	3	0	0	3
APL720	Computational Fluid Dynamics	3	0	2	4
APL737	Advanced Design of Machine Elements	3	0	0	3
APL745	Deep Learning for Mechanics	3	0	2	4
APL765	Fracture Mechanics	3	0	0	3
APL796	Advanced Solid Mechanics	3	0	0	3
APL805	Advanced Finite Element Method	3	0	0	3
APL831	Theory of Plates and Shells	3	0	0	3
APL835	Mechanics of Composite Materials	3	0	0	3

Materials (Program Electives)

APL750	Modern Engineering Materials	3	0	0	3
APL756	Microstructural Characterization of Materials	3	0	2	4
APL759	Phase Transformations	3	0	0	3
APL763	Micro & Nanoscale Mechanical Behaviour of Materials	3	0	2	4
APL764	Mechanical Behaviour of Biomaterials	3	0	0	3
APL765	Fracture Mechanics	3	0	0	3
APL767	Engineering Failure Analysis and Prevention	3	0	0	3
APL	Selected Topics in Material Engineering	3	0	0	3

Semester wise course breakup for two streams

Sem.	Courses (Number, Abbreviated Title, L-T-P, credits)							Lecture courses	Contact h/week				Credits
	L	T	P	Total									
I	APL775 Design Methods (3-0-0) 3	APL734 Advanced Dynamics (3-0-0) 3	APL703 Engineering Mathematics & Computation (3-0-2) 4	APL701 Continuum Mechanics (3-0-0) 3	APL702 Experimental Methods for Solids & Fluids (2-0-2) 3			5	14	0	4	18	16
II	PE-1	PE-2	PE-3	OE-1				4	12	0	0	12	12
Summer													
III	OE2	AMP811	PE-4					2	6	0	12	18	12
IV	AMP812							0	0	0	24	24	12

Total = 52

Master of Technology in Chemical Engineering

Department of Chemical Engineering

The overall credits structure

Category	PC	PE	OE	Total
Credits	37	12	3	52

Program Core

CLD771	Minor Project	0	0	6	3
CLD781	Major Project Part-I	0	0	168	
CLD782	Major Project Part-II	0	0	24	12
CLL701	Modelling of Transport Processes	2	0	0	2
CLL702	Principles of Thermodynamics, Reaction Kinetics and Reactors	2	0	0	2
CLL703	Process Engineering	3	0	0	3
CLP704	Technical Communication for Chemical Engineers	0	0	2	1
CLL731	Advanced Transport Phenomena	3	0	0	3
CLL733	Industrial Multiphase Reactors	3	0	0	3
Total Credits				37	

CLL743	Petrochemicals Technology	3	0	0	3
CLL761	Chemical Engineering Mathematics	3	0	0	3
CLL762	Advanced Computational Techniques in Chemical Engineering	2	0	2	3
CLL766	Interfacial Engineering	3	0	0	3
CLL767	Structures and Properties of Polymers	3	0	0	3
CLL768	Fundamentals of Computational Fluid Dynamics	2	0	2	3
CLL769	Applications of Computational Fluid Dynamics	2	0	2	3
CLL771	Introduction to Complex Fluids	3	0	0	3
CLL772	Transport Phenomena in Complex Fluids	3	0	0	3
CLL773	Thermodynamics of Complex Fluids	3	0	0	3
CLL774	Simulation Techniques for Complex Fluids	3	0	0	3
CLL775	Polymerization Process Modeling	3	0	0	3
CLL776	Granular Materials	3	0	0	3
CLL777	Complex Fluids Technology	3	0	0	3
CLL778	Interfacial Behaviour and Transport of Biomolecules	3	0	0	3
CLL779	Molecular Biotechnology and in-vitro Diagnostics	3	0	0	3
CLL780	Bioprocessing and Bioseparations	3	0	0	3
CLL781	Process Operations Scheduling	3	0	0	3
CLL782	Process Optimization	3	0	0	3
CLL783	Advanced Process Control	3	0	0	3
CLL784	Process Modeling and Simulation	3	0	0	3
CLL785	Evolutionary Optimization	3	0	0	3
CLL786	Fine Chemicals Technology	3	0	0	3
CLL787	Statistical Methods for Chemical Engg.	3	0	0	3
CLL788	Process Data Analytics	3	0	0	3
CLL791	Chemical Product and Process Integration	3	0	0	3
CLL792	Chemical Product Development and Commercialization	3	0	0	3
CLL793	Membrane Science and Engineering	3	0	0	3
CLL794	Petroleum Refinery Engineering	3	0	0	3
CLL798	Selected Topics in Chemical Engineering-I	3	0	0	3
CLL799	Selected Topics in Chemical Engineering-II	3	0	0	3
CLV796	Current Topics in Chemical Engineering	1	0	0	1
CLV797	Recent Advances in Chemical Engineering	2	0	0	2

Program Electives

CLL705	Petroleum Reservoir Engineering	3	0	0	3
CLL706	Petroleum Production Engineering	3	0	0	3
CLL707	Population Balance Modeling	3	0	0	3
CLL720	Principles of Electrochemical Engineering	3	0	0	3
CLL721	Electrochemical Methods	3	0	0	3
CLL722	Electrochemical Conversion and Storage Devices	3	0	0	3
CLL723	Hydrogen Energy and Fuel Cell Technology	3	0	0	3
CLL724	Environmental Engineering and Waste Management	3	0	0	3
CLL725	Air Pollution Control Engineering	3	0	0	3
CLL726	Molecular Modeling of Catalytic Reactions	3	0	0	3
CLL727	Heterogeneous Catalysis and Catalytic Reactors	3	0	0	3
CLL728	Biomass Conversion and Utilization	3	0	0	3
CLL730	Structure, Transport and Reactions in BioNano Systems	3	0	0	3
CLL732	Advanced Chemical Engineering Thermodynamics	3	0	0	3
CLL734	Process Intensification and Novel Reactors	3	0	0	3
CLL735	Design of Multicomponent Separation Processes	3	0	0	3
CLL736	Experimental Characterization of Multiphase Reactors	3	0	0	3
CLL742	Experimental Characterization of BioMacromolecules	3	0	0	3

Sem.	Courses (Number, Abbreviated Title, L-T-P, credits)						Lecture courses	Contact h/week				Credits
	L	T	P	Total								
I	CLL701 Modelling of Transport Processes (2-0-0) 2	CLL702 Principles of Thermodynamics, Reaction Kinetics and Reactors (2-0-0) 2	CLL703 Process Engineering (3-0-0) 3	PE-1 (3-0-0) 3	PE-2 (3-0-0) 3		5	13	0	0	13	13
II	CLL731 Advanced Transport Phenomena (3-0-0) 3	CLL733 Industrial Multiphase Reactors (3-0-0) 3	CLD771 Minor Project (0-0-6) 3	PE-3 (3-0-0) 3	CLP704 Tech. Commu. Chem. Engineers (0-0-2) 1		3	9	0	8	17	13
Summer												
III			CLD781 Major Project Part-I (0-0-16) 8	PE-4 (3-0-0) 3	OE-1 (3-0-0) 3		2	6	0	18	22	14
IV			CLD782 Major Project Part-II (0-0-24) 12				0	0	0	24	24	12

Total = 52

Master of Technology in Molecular Engineering : Chemical Synthesis and Analysis

Department of Chemistry

The overall credits structure

Category	PC	PE	OE	Total
Credits	42	12	-	54

Program Core

CMD806	Major Project Part-I	0	0	189
CMD807	Major Project Part-II	0	0	189
CML721	Design and Synthesis of Organic Molecules	3	0	0 3
CML724	Synthesis of Industrially Important Inorganic Materials	3	0	0 3
CML726	Cheminformatics and Molecular Modelling	3	0	0 3
CMP728	Instrumentation Laboratory	0	0	6 3
CML729	Material Characterization	3	0	0 3
CML731	Chemical Separation and Electroanalytical Methods	3	0	0 3
CML737	Applied Spectroscopy	3	0	0 3
CMP722	Synthesis of Organic and Inorganic Compounds	0	0	6 3
Total Credits				42

Program Electives

CMD799	Minor project	0	0	6 3
CML723	Principles and practice of NMR and Optical Spectroscopy	3	0	0 3
CML733	Chemistry of Industrial Catalysts	3	0	0 3
CML734	Chemistry of Nanostructured Materials	3	0	0 3
CML738	Applications of P-Block Elements and their Compounds	3	0	0 3
CML739	Applied Biocatalysis	3	0	0 3
CML740	Chemistry of Heterocyclic Compounds	3	0	0 3
CML741	Organo and Organometallic Catalysis	3	0	0 3
CML742	Reagents in Synthetic Transformations	3	0	0 3
CML801	Molecular Modelling and Simulations: Concepts and Techniques	3	0	0 3

Sem.	Courses (Number, Abbreviated Title, L-T-P, credits)						Lecture courses	Contact h/week				Credits
	L	T	P	Total	L	T		P	Total			
I	CML721 Design & Synthesis (3-0-0) 3	CML726 Cheminformatics (3-0-0) 3	CML731 Separation & Electroanalytical (3-0-0) 3	CMP722 Lab on Synthesis (0-0-6) 3	PE/OE-1 (3-0-0) 3		4	12	0	6	18	15
II	CML724 Inorganic Materials (3-0-0) 3	CML729 Material Characterization (3-0-0) 3	CML737 Applied Spectroscopy (3-0-0) 3	CMP728 Instru. Lab. (0-0-6) 3	PE/OE-2 (3-0-0) 3		4	12	0	6	18	15
III	CMD805 Major Project Part-I (0-0-12) 6	PE/OE-3 (3-0-0) 3	PE/OE-4 (3-0-0) 3				2	6	0	18	24	12
IV	CMD807 Major Project Part-II (0-0-24) 12						0	0	0	18	18	12

Total = 54

Master of Technology in Construction Technology and Management

Department of Civil Engineering

The overall credits structure

Category	PC	PE	OE	Total
Credits	37.5	15	0	52.5

Program Core

CVC771	Seminar In Construction Technology and Management-I	0	0	2	0
CVC772	Seminar In Construction Technology and Management-II	0	0	2	0
CVD772	Major Project Part-I (CEC)	0	0	18	9
CVD773	Major Project Part-II (CEC)	0	0	24	12
CVL772	Construction Project Management	3	0	0	3
CVL773	Quantitative Methods in Construction Management	3	0	0	3
CVL774	Construction Contract Management	3	0	0	3
CVL775	Construction Economics and Finance	3	0	0	3
CVL776	Construction Practices and Equipment	3	0	0	3
CVP772	Computational Laboratory for Construction Management	0	0	3	1.5
Total Credits				37.5	

ELL755	Variable Reluctance Machines	3	0	0	3
ELL756	Special Electrical Machines	3	0	0	3
ELL757	Energy Efficient Motors	3	0	0	3
ELL758	Power Quality	3	0	0	3
ELL759	Power Electronic Converters for Renewable Energy Systems	3	0	0	3
ELL760	Switched Mode Power Conversion	3	0	0	3
ELL761	Power Electronics for Utility Interface	3	0	0	3
ELL762	Intelligent Motor Controllers	3	0	0	3
ELL763	Advanced Electric Drives	3	0	0	3
ELL764	Electric Vehicles	3	0	0	3
ELL765	Smart Grid Technology	3	0	0	3
ELL766	Appliance Systems	3	0	0	3
ELL767	Mechatronics	3	0	0	3
ELL770	Power System Analysis	3	0	0	3
ELL771	Advanced Power System Protection	3	0	0	3
ELL772	Planning and Operation of a Smart Grid	3	0	0	3
ELL773	High Voltage DC Transmission	3	0	0	3
ELL774	Flexible AC Transmission system	3	0	0	3
ELL775	Power System Dynamics	3	0	0	3
ELL776	Advanced Power System Optimization	3	0	0	3
ELL777	Power System operation and control	3	0	0	3
ELL778	Dynamic Modelling And Control of Sustainable Energy Systems	3	0	0	3
ELL850	Digital Control of Power Electronics and Drive Systems	3	0	0	3
ELL851	Computer Aided Design of Electrical Machines	3	0	0	3
ELL852	Condition Monitoring of Electrical Machines	3	0	0	3
ELL853	Advanced Topics in Electrical Machines	3	0	0	3
ELL854	Selected Topics in Electrical Machines	3	0	0	3
ELL855	High Power Converters	3	0	0	3
ELL856	Advanced Topics in Power Electronics	3	0	0	3
ELL857	Selected Topics in Power Electronics	3	0	0	3
ELL858	Advanced Topics in Electric Drives	3	0	0	3
ELL859	Selected Topics in Electric Drives	3	0	0	3
ELL870	Restructured Power System	3	0	0	3
ELL871	Distribution System Operation and Planning	3	0	0	3
ELL872	Selected Topics in Power System	3	0	0	3
ELL873	Power System Transient	3	0	0	3
ELL874	Power System Reliability	3	0	0	3
ELP850	Electrical Machines Laboratory	0	0	3	1.5
ELP851	Power Electronics Laboratory	0	0	3	1.5
ELP852	Electrical Drives Laboratory	0	0	3	1.5
ELP853	DSP Based Control of Power Electronics and Drives Laboratory	0	0	3	1.5
ELP854	Electrical Machines CAD Laboratory	0	1	4	3
ELP855	Smart Grids Laboratory	0	1	4	3
ELP870	Power System Lab I	0	1	4	3
ELP871	Power System Lab II	0	1	4	3
ESL718	Power Generation, Transmission and Distribution	3	0	0	3
ESL732	Bioconversion and Processing of Waste	3	0	0	3
ESL734	Nuclear Energy	3	0	0	3
ESL740	Non-conventional Sources of Energy	3	0	0	3
ESL746	Hydrogen Energy	3	0	0	3
ESL768	Wind Energy and Hydro Power Systems	3	0	0	3
ESL770	Solar Energy Utilization	3	0	0	3
ESL870	Fusion Energy	3	0	0	3

Program Electives for All Background

CVD771	Minor Project (CEC)	0	0	6	3
CVS771	Independent Study (CEC)	0	3	0	3
MCL754	Operations Planning and Control	3	0	0	3
MCL756	Supply Chain Management	3	0	0	3
MCL757	Logistics	3	0	0	3
MCL771	Value Engineering and Life Cycle Costing	3	0	0	3
MSL705	HRM Systems	2	0	0	1.5
MSL804	Procurement Management	3	0	0	3
MSL822	International Business	3	0	0	3
MSL846	Total Productivity Management	3	0	0	3
MCL772	Reliability Engineering	3	0	0	3

Program Electives for Civil Engineering Background

EEL747	Electrical Systems for Construction Industries	3	0	2	4
CVL702	Ground Improvement and Geosynthetics	3	0	0	3
CVL714	Field Exploration and Geotechnical Processes	3	0	0	3
CVL715	Excavation Methods and Underground Space Technology	3	0	0	3
CVL727	Environmental risk assessment	3	0	0	3
CVL747	Transportation Safety and Environment	3	0	0	3
CVL750	Intelligent Transportation Systems	3	0	0	3
CVL765	Concrete Mechanics	3	0	0	3
CVL771	Advanced Concrete Technology	3	0	0	3
CVL777	Building Science	3	0	0	3
CVL778	Building Services and Maintenance Management	3	0	0	3
CVL779	Formwork for Concrete Structures	3	0	0	3
CVL820	Environmental Impact Assessment	3	0	0	3
CVL838	Geographic Information Systems	2	0	2	3
CVL840	Planning and Design of Sustainable Transport Systems	3	0	0	3
CVL871	Durability and Repair of Concrete Structures	3	0	0	3
CVL872	Infrastructure Development and Management	3	0	0	3
CVL873	Fire Engineering and Design	3	0	0	3
CVL874	Quality and Safety in Construction	3	0	0	3
CVL875	Sustainable Materials and Green Buildings	3	0	0	3

Program Electives for Electrical Engineering Background

ELL700	Linear Systems Theory	3	0	0	3
ELL712	Digital Communications	3	0	0	3
ELL750	Modelling of Electrical Machines	3	0	0	3
ELL751	Power Electronic Converters	3	0	0	3
ELL752	Electric Drive System	3	0	0	3
ELL753	Physical Phenomena in Electrical Machines	3	0	0	3
ELL754	Permanent Magnet Machines	3	0	0	3

Program Electives for Mechanical Engineering Background

EEL747	Electrical Systems for Construction Industries	3	0	2	4
ESL768	Wind Energy & Hydro Power System	3	0	0	3
ITL709	Maintenance Planning and Control	3	0	0	3
ITL752	Bulk Materials Handling	2	0	2	3

MCL749	Mechatronics Product Design	3	0	2	4	MCL784	Computer Aided Manufacturing	3	0	2	4
MCL751	Industrial Engineering Systems	1	0	4	3	MCL785	Advanced Machining Processes	3	0	0	3
MCL753	Manufacturing Informatics	3	0	2	4	MCL787	Welding Science and Technology	3	0	2	4
MCL755	Service System Design	3	0	0	3	MCL788	Surface Engineering	3	0	2	4
MCL769	Metal Forming Analysis	3	0	2	4	MCL791	Processing and Mechanics of Composite Materials	3	0	2	4
MCL776	Advances in Metal Forming	3	0	0	3	MCL792	Injection Molding and Mold Design	2	0	2	3
MCL778	Design and Metallurgy of Welded Joints	3	0	2	4	MCL818*	Heating, Ventilating and Air-conditioning	3	0	2	3
MCL780	Casting Technology	3	0	2	4	MCL866	Maintenance Management	3	0	0	3
MCL781	Machining Processes and Analysis	3	0	2	4						
MCL783	Automation in Manufacturing	3	0	2	4						

Sem.	Courses (Number, Abbreviated Title, L-T-P, Credits)						Lecture courses	Contact h/week				Credits
	L	T	P	Total								
I	CVL772 Construction Project Management (3-0-0) 3	CVL773 Quantitative Methods in Construction Management (3-0-0) 3	CVP772 Computational Laboratory for Construction Management (0-0-3) 1.5	CVC771 Seminar In Construction Technology and Management-I (0-0-2) 0	PE-1 (3-0-0) 3	PE-2 (3-0-0) 3	4	12	0	5	17	13.5
II	CVL775 Construction Economics and Finance (3-0-0) 3	CVL776 Construction Practices and Equipment (3-0-0) 3	CVL774 Construction Contract Management (3-0-0) 3	CVC772 Seminar In Construction Technology and Management-II (0-0-2) 0	PE-3 (3-0-0) 3		4	12	0	2	14	12
Summer												
III	CVD772 Major Project Part-I (CEC) (0-0-18) 9	PE-4 (3-0-0) 3	PE-5 (3-0-0) 3				2	6	0	18	24	15
IV	CVD773 Major Project Part-II (CEC) (0-0-24) 12						0	0	0	24	24	12

Total = 52.5

Master of Technology in Geotechnical and Geoenvironmental Engineering

Department of Civil Engineering

The overall credits structure

Category	PC	PE	OE	Total
Credits	36	12	0	48

Program Core

CVD800	Major Project Part-I	0	0	12	6
CVD801	Major Project Part-II	0	0	24	12
CVL700	Engineering Behaviour of Soils	3	0	0	3
CVL701	Site Investigation and Foundation Design	3	0	0	3
CVL702	Ground Improvement and Geosynthetics	3	0	0	3
CVL703	Geoenvironmental Engineering	3	0	0	3
CVP700	Soil Engineering Lab	0	0	6	3
CVP800	Geoenvironmental and Geotechnical Engineering Lab	0	0	6	3
Total Credits				36	

Program Electives

CVD700*	Minor Project	0	0	6	3
CVL704	Finite Element Method in Geotechnical Engg.	3	0	0	3
CVL705	Slopes and Retaining Structures	3	0	0	3
CVL706	Soil Dynamics and Earthquake Geotechnical Engineering	3	0	0	3
CVL707	Soil-Structure Interaction Analysis	3	0	0	3
CVL708	Geotechnology of Waste Disposal Facilities	3	0	0	3
CVL709	Offshore Geotechnical Engineering	3	0	0	3
CVL800	Emerging Topics in Geotechnical Engineering	3	0	0	3
CVL801	Constitutive Modelling in Geotechnics	3	0	0	3
CVS800	Independent Study	0	3	0	3

* This course is only for Part-Time students in lieu of CVP800 and DAAD students.

Sem.	Courses (Number, Abbreviated Title, L-T-P, credits)					Lecture courses	Contact h/week				Credits
	L	T	P	Total							
I	CVL700 Engineering Behaviour of Soils (3-0-0) 3	CVL701 Site Investigation and Foundation Design (3-0-0) 3	CVP700 Soil Engineering Lab (0-0-6) 3	PE-1 (3-0-0) 3		3	9	0	6	15	12
II	CVL702 Ground Improvement and Geosynthetics (3-0-0) 3	CVL703 Geoenvironmental Engineering (3-0-0) 3	CVP800 Geoenvironmental and Geotechnical Engg. Lab/ CVD700 Minor Project (for Part Time Students) (0-0-6) 3	PE-2 (3-0-0) 3	PE-3 (3-0-0) 3	4	12	0	6	18	15
Summer											
III	CVD800 Major Project Part-I (0-0-12) 6	PE-4 (3-0-0) 3				1	3	0	12	15	9
IV	CVD801 Major Project Part-II (0-0-24) 12					0	0	0	24	24	12

Total = 48

Master of Technology in Transportation Engineering

Department of Civil Engineering

The overall credits structure

Category	PC	PE	OC	Total
Credits	36	18	0	54

Including 6 Credits of Restricted Electives

Program Core

CVD853	Major Project Part-I	0	0	18	9
CVD854	Major Project Part-II	0	0	24	12
CVL740	Pavement Materials and Design of Pavements	3	0	2	4
CVL741	Urban and Regional Transportation Planning	3	0	2	4
CVL742	Traffic Engineering	3	0	2	4
CVS852	Advanced Topics in Transportation Engineering	0	0	6	3
Total Credits				36	

Program Electives

CVL743	Airport Planning and Design	3	0	0	3
CVL744	Transportation Infrastructure Design	2	0	2	3
CVL745	Modeling of Pavement Materials	2	0	2	3
CVL746	Public Transportation Systems	3	0	0	3
CVL747	Transportation Safety and Environment	3	0	0	3
CVL749	Planning and Design of Bus Transportation System	3	0	0	3
CVL750	Intelligent Transportation Systems	3	0	0	3
CVL840	Planning and Design of Sustainable Transport Systems	3	0	0	3
CVL841	Advanced Transportation Modelling	2	0	2	3
CVL842	Geometric Design of Roads	2	0	2	3
CVL844	Transportation Infrastructure Management	3	0	0	3
CVL845	Viscoelastic Behavior of Bituminous Materials	3	0	0	3
CVL846	Transportation System Management	3	0	0	3
CVL847	Transportation Economics	3	0	0	3
CVL849	Traffic Flow Modelling	3	0	0	3
CVL850	Transportation Logistics	3	0	0	3
CVL851	Special Topics in Transportation Engineering	3	0	0	3
CVS754	Independent Study	0	3	0	3

Restricted Electives (6 Credits)

CVL763	Analytical & Numerical Methods in Structural Engineering	3	0	0	3
CVL729	Environmental Statistics and Experimental Design	2	0	2	3
MCL761	Probability and Statistics	3	0	0	3
CVL731	Optimization Techniques in Water Resources	3	0	0	3
CVL748	Data Analysis for Transportation Engineering	3	0	0	3
CVS753	Minor Project in Transportation Engineering	0	0	6	3

Sem.	Courses (Number, Abbreviated Title, L-T-P, credits)					Lecture courses	Contact h/week				Credits
	L	T	P	Total							
I	CVL741 Urban & Regional Transport Planning (3-0-2) 4	CVL740 Pavement Materials and Design of Pavements (3-0-2) 4	CVL742 Traffic Engineering (3-0-2) 4	RE-1* (3-0-0 or 2-0-2) 3			Min. 11 Max. 12	0	Min. 6 Max. 8	18	15
II	PE-1 (2-0-2) 3	PE-2 (2-0-2) 3	PE-3 (2-0-2) 3	RE-2# (3-0-0 or 2-0-2) 3			Min. 8 Max. 9		Min. 6 Max. 8	12	12
Summer	CVS852 Advanced Topics in Transportation Engineering (0-0-6) 3										3
III	PE-4 (2-0-2) 3	CVD853 Major Project Part-I (0-0-18) 9					0	0	6	6	12
IV	CVD854 Major Project Part-II (0-0-24) 12						3	0	18	24	12

* Should be listed in restricted elective course category.

Any course (relevant to research area) offered in that semester with consent of thesis supervisor. Alternatively minor project can be opted.

Total = 54

Master of Technology in Structural Engineering

Department of Civil Engineering

The overall credits structure

Category	PC	PE	OC	Total
Credits	42	12	0	54

Program Core

CVD757	Major Project Part-I (CES)		0	0	189	CVL769	Design of Tall Buildings	3	0	0	3	
CVD758	Major Project Part-II (CES)		0	0	189	CVL770	Prestressed and Composite Structures	2	0	2	3	
CVL756	Advanced Structural Analysis		3	0	0	3	CVL856	Strengthening and Retrofitting of Structures	3	0	0	3
CVL757	Finite Element Methods in Structural Engineering		2	0	2	3	CVL857	Structural Safety and Reliability	3	0	0	3
CVL758	Solid Mechanics in Structural Engineering		3	0	0	3	CVL858	Theory of Plates and Shells	3	0	0	3
CVL759	Structural Dynamics		3	0	0	3	CVL859	Theory of Structural Stability	3	0	0	3
CVL760	Theory of Concrete Structures		3	0	0	3	CVL860	Advanced Finite Element Method and Programming	2	0	2	3
CVL761	Theory of Steel Structures		3	0	0	3	CVL861	Analysis and Design of Machine Foundations	2	0	2	3
CVL762	Earthquake Analysis and Design		3	0	0	3	CVL862	Design of Offshore Structures	3	0	0	3
CVP756	Structural Engineering Laboratory		0	0	6	3	CVL863	General Continuum Mechanics	3	0	0	3
Total Credits					42							

Program Electives

CVD756	Minor Project in Structural Engineering		0	0	6	3	CVL864	Structural Health Monitoring	2	0	2	3
CVL763	Analytical and Numerical Methods for Structural Engineering		3	0	0	3	CVL865	Structural Vibration Control	3	0	0	3
CVL764	Blast Resistant Design of Structures		2	0	2	3	CVL866	Wind Resistant Design of Structures	3	0	0	3
CVL765	Concrete Mechanics		3	0	0	3	CVS756	Independent Study (CES)	0	3	0	3
CVL766	Design of Bridge Structures		3	0	0	3	CVL771	Advanced Concrete Technology	3	0	0	3
CVL767	Design of Fiber Reinforced Composite Structures		3	0	0	3	CVL873	Fire Engineering and Design	3	0	0	3
CVL768	Design of Masonry Structures		3	0	0	3	CVL779	Formwork for Concrete Structures	3	0	0	3
							CVL871	Durability and Repair of Concrete Structures	3	0	0	3
							CVL868	Waves through Periodic Structures and Metamaterials	3	0	0	3
							CVL867	Atomistic & Multiscale Modelling of Materials	3	0	0	3
							CVL869	Probabilistic Structural Dynamics	3	0	0	3

Sem.	Courses (Number, Abbreviated Title, L-T-P, credits)						Lecture courses	Contact h/week				Credits
	L	T	P	Total								
I	CVL756 Advanced Structural Analysis (3-0-0) 3	CVL759 Structural Dynamics (3-0-0) 3	CVL757 Finite Element Methods in Structural Engineering (2-0-2) 3	CVL758 Solid Mechanics in Structural Engineering (3-0-0) 3	PE-1 (3-0-0) 3 or (2-0-2) 3		5	(13, 14)	0	(2,4)	(16, 17)	15
II	CVP756 Structural Engineering Laboratory (0-0-6) 3	CVL762 Earthquake Analysis and Design (3-0-0) 3	CVL760 Theory of Concrete Structures (3-0-0) 3	CVL761 Theory of Steel Structures (3-0-0) 3	PE-2 (3-0-0) 3 or (2-0-2) 3		4	(11, 12)	0	(6,8)	(18, 19)	15
Summer												
III	CVD757 Major Project Part I (CES) (0-0-18) 9	PE-3 (3-0-0) 3 or (2-0-2) 3	PE-4 (3-0-0) 3 or (2-0-2) 3				2	(4,6)	0	(18, 22)	(24, 26)	15
IV	CVD758 Major Project Part II (CES) (0-0-18) 9						0	0	0	18	18	9

Total = 54

Master of Technology in Construction Engineering and Management

Department of Civil Engineering

The overall credits structure

Category	PC	PE	OC	Total
Credits	42	12	0	54

Program Core

CVD777	Major Project Part-I (CET)	0	0	18	9
CVD778	Major Project Part-II (CET)	0	0	24	12
CVL771	Advanced Concrete Technology	3	0	0	3
CVL772	Construction Project Management	3	0	0	3
CVL773	Quantitative Methods in Construction Management	3	0	0	3
CVL774	Construction Contract Management	3	0	0	3
CVL775	Construction Economics and Finance	3	0	0	3
CVL776	Construction Practices and Equipment	3	0	0	3
CVP771	Construction Technology Laboratory	0	0	3	1.5
CVP772	Computational Laboratory for Construction Management	0	0	3	1.5
Total Credits				42	

Program Electives

CVD776	Minor Project (CET)	0	0	6	3
CVL765	Concrete Mechanics	3	0	0	3
CVL777	Building Science	3	0	0	3
CVL778	Building Services and Maintenance Management	3	0	0	3
CVL779	Formwork for Concrete Structures	3	0	0	3
CVL871	Durability and Repair of Concrete Structures	3	0	0	3
CVL872	Infrastructure Development and Management	3	0	0	3
CVL873	Fire Engineering and Design	3	0	0	3
CVL874	Quality and Safety in Construction	3	0	0	3
CVL875	Sustainable Materials and Green Buildings	3	0	0	3
CVL876	Digital Design and Construction	2	0	2	3
CVS776	Independent Study (CET)	0	3	0	3

Sem.	Courses (Number, Abbreviated Title, L-T-P, Credits)						Lecture courses	Contact h/week				Credits
	L	T	P	Total								
I	CVL772 Construction Project Management (3-0-0) 3	CVL773 Quantitative Methods in Construction Management (3-0-0) 3	CVL771 Advanced Concrete Technology (3-0-0) 3	CVP772 Computational Laboratory for Construction Management (0-0-3) 1.5	PE-1 (3-0-0) 3		4	12	0	3	15	13.5
II	CVL775 Construction Economics and Finance (3-0-0) 3	CVL776 Construction Practices and Equipment (3-0-0) 3	CVL774 Construction Contract Management (3-0-0) 3	CVP771 Construction Technology Laboratory (0-0-3) 1.5	PE-2 (3-0-0) 3		4	12	0	3	15	13.5
Summer												
III	CVD777 Major Project Part-I (CET) (0-0-18) 9	PE-3 (3-0-0) 3	PE-4 (3-0-0) 3				2	6	0	18	24	15
IV	CVD778 Major Project Part-II (CET) (0-0-24) 12						0	0	0	24	24	12

Total = 54

Master of Technology in Rock Engineering and Underground Structures

Department of Civil Engineering

The overall credits structure

Category	PC	PE	OC	Total
Credits	36	12	0	48

Program Core

CVD810	Major Project Part-I			0	0	12	6
CVD811	Major Project Part-II			0	0	24	12
CVL710	Engineering Properties of Rocks and Rock Masses	3	0	0	3		
CVL711	Structural Geology	3	0	0	3		
CVL712	Slopes and Foundations	3	0	0	3		
CVL713	Analysis and Design of Underground Structures	3	0	0	3		
CVP710	Rock Mechanics Laboratory-I			0	0	6	3
CVP810	Rock Mechanics Laboratory-II			0	0	6	3
Total Credits				36			

Program Electives

CVD710*	Minor Project			0	0	6	3
CVL704	Finite Element Method in Geotechnical Engg.	3	0	0	3		
CVL714	Field Exploration and Geotechnical Processes	3	0	0	3		
CVL715	Excavation Methods and Underground Space Technology	3	0	0	3		
CVL716	Environmental Rock Engineering	3	0	0	3		
CVL810	Emerging Topics in Rock Engineering and Underground Structures	3	0	0	3		
CVL811	Numerical and Computer Methods in Geomechanics	3	0	0	3		
CVS810	Independent Study			0	0	6	3

* This course is only for Part-Time students in lieu of CVP800 and DAAD students.

Sem.	Courses (Number, Abbreviated Title, L-T-P, Credits)						Lecture courses	Contact h/week				Credits
	L	T	P	Total								
I	CVL710 Engineering Properties of Rocks and Rock Masses (3-0-0) 3	CVL711 Structural Geology (3-0-0) 3	CVP710 Rock Mechanics Laboratory-I (0-0-6) 3	PE-1 (3-0-0) 3			3	9	0	6	15	12
II	CVL712 Slopes and Foundations (3-0-0) 3	CVL713 Analysis and Design of Underground Structures (3-0-0) 3	CVP810 Rock Mechanics Laboratory-II / CVD710 Minor Project (0-0-6) 3	PE-2 (3-0-0) 3	PE-3 (3-0-0) 3		4	12	0	6	18	15
Summer												
III	CVD810 Major Project Part-I (0-0-12) 6	PE-4 (3-0-0) 3					1	3	0	12	15	9
IV	CVD811 Major Project Part-II (0-0-24) 12						0	0	0	24	24	12

Total = 48

Master of Technology in Environmental Engineering and Management

Department of Civil Engineering

The overall credits structure

Category	PC	PE	OC	Total
Credits	39	9	6	54

Program Core

CVD720	Major Thesis Part-I		0	0	12	6
CVD721	Major Thesis Part-II		0	0	24	12
CVD726	Minor Project		0	0	6	3
CVL720	Air Pollution and Control		3	0	0	3
CVL721	Solid Waste Engineering		3	0	0	3
CVL722	Water Engineering		3	0	0	3
CVL723	Wastewater Engineering		3	0	0	3
CVL724	Environmental Systems Analysis		3	0	0	3
CVL725	Environmental Chemistry and Microbiology		1	0	4	3
Total Credits						39

CVL820	Environmental Impact Assessment		3	0	0	3
CVL821	Industrial Waste Management and Audit		3	0	0	3
CVL822	Emerging Technologies for Environmental Management		3	0	0	3
CVL823	Thermal Techniques for Waste Management		3	0	0	3
CVL824	Life Cycle Analysis and Design for Environment		3	0	0	3
CVL825	Fundamental of Aerosol: Health and Climate Change		3	0	0	3
CVL826	Quantitative Microbial Risk Assessment		1	0	0	1
CVL827	Environmental Implications of Engineered Nanomaterials		2	0	0	2
CVL828	Water Distribution and Sewerage Network Design		3	0	0	3
CVP820	Advanced Air Pollution Laboratory		1	0	4	3
CVP821	Advanced Water and Wastewater Laboratory		1	0	4	3
CVS720	Independent Study		0	3	0	3

Program Electives

CVL727	Environmental risk assessment		3	0	0	3
CVL728	Environmental Quality Modeling		3	0	0	3
CVL729	Environmental Statistics and Experimental Design		2	0	2	3

Sem.	Courses (Number, Abbreviated Title, L-T-P, Credits)					Lecture courses	Contact h/week				Credits
	L	T	P	Total							
I	CVL725 Environmental Chemistry and Microbiology (1-0-4) 3	CVL722 Water Engineering (3-0-0) 3	CVL720 Air pollution and control (3-0-0) 3	PE-1 (3-0-0) 3 or (2-0-2) 3 or (1-0-4)		4	(8, 10)	0	(4,8)	(14, 16)	12
II	CVL721 Solid Waste Engineering (3-0-0) 3	CVL724 Environmental Systems Analysis (3-0-0) 3	CVL723 Wastewater Engineering (3-0-0) 3	PE-2 (3-0-0) 3 or (2-0-2) 3 or (1-0-4)	OE-1 (3-0-0) 3	5	(13, 15)	0	(0,4)	(15, 17)	15
Summer	CVD726 Minor project (0-0-6) 3										3
III	CVD720 Major Thesis Part-I (0-0-12) 6			PE-3 (3-0-0) 3 or (2-0-2) 3 or (1-0-4)	OE-2 (3-0-0) 3	2	(4,6)	0	(12, 16)	(18, 20)	12
IV	CVD721 Major Thesis Part-II (0-0-24) 12					0	0	0	24	24	12

Total = 54

Master of Technology in Water Resources Engineering

Department of Civil Engineering

The overall credits structure

Category	PC	PE	OC	Total
Credits	39	15	0	54

Program Core

CVD831	Major Project Part-I	0	0	12	6	CVL737	Environmental Dynamics and Management	3	0	0	3
CVD832	Major Project Part-II	0	0	24	12	CVL738	Economic Aspects of Water Resources Development	3	0	0	3
CVL730	Hydrologic Processes and Modeling	3	0	0	3	CVL830	Groundwater Flow and Pollution Modeling	3	0	0	3
CVL731	Optimization Techniques in Water Resources	3	0	0	3	CVL831	Surface Water Quality Modeling and Control	3	0	0	3
CVL732	Groundwater Hydrology	3	0	0	3	CVL832	Hydroelectric Engineering	3	0	0	3
CVL733	Stochastic Hydrology	2	0	2	3	CVL833	Water Resources Systems	3	0	0	3
CVL734	Advanced Hydraulics	3	0	0	3	CVL834	Urban Water Infrastructure	3	0	0	3
CVL735	Finite Element in Water Resources	3	0	0	3	CVL835	Eco-hydraulics and Hydrology	3	0	0	3
CVP730	Simulation Laboratory-I	0	0	3	1.5	CVL836	Advanced Hydrologic Land Surface Processes	3	0	0	3
CVP731	Simulation Laboratory-II	0	0	3	1.5	CVL837	Mechanics of Sediment Transport	2	0	2	3
Total Credits				39		CVL838	Geographic Information Systems	2	0	2	3

Program Electives

CVL736	Soft Computing Techniques in Water Resources	2	0	2	3	CVL839	Hydrologic Applications of Remote Sensing	2	0	2	3
						CVS730	Minor Project	0	0	6	3
						CVS830	Independent Study	0	3	0	3

Sem.	Courses (Number, Abbreviated Title, L-T-P, Credits)						Lecture courses	Contact h/week				Credits
	L	T	P	Total								
I	CVL730 Hyd. Process (3-0-0) 3	CVL731 Opt. Tech. (3-0-0) 3	CVL732 GW Hyd. (3-0-0) 3	CVL735 Stochastic Hyd. (2-0-2) 3	PE-1 (3-0-0) 3 or (2-0-2) 3		5	14/13	0	2/4	16/17	15
II	CVL733 Adv. Hydraulics (3-0-0) 3	CVL734 Finite Element (3-0-0) 3	CVP730 Sim. Lab-I (0-0-3) 1.5	CVP731 Sim. Lab-II (0-0-3) 1.5	PE-2 (3-0-0) 3 or (2-0-2) 3	PE-3 (3-0-0) 3 or (2-0-2) 3	4	12-10	0	6-10	18-20	15
Summer	Major Project Part I (CEW)											0
III	CVD831 Major Project Part-I (0-0-12) 6			PE-4 (3-0-0) 3 or (2-0-2) 3	PE-5 (3-0-0) 3 or (2-0-2) 3		2	6-4	0	12-16	18-20	12
IV	CVD832 Major Project Part-II (0-0-24) 12						0	0	0	24	24	12

Total = 54

Master of Technology in Computer Science and Engineering

Department of Computer Science and Engineering

The overall credits structure

Category	PC	PE	OC	Total
Credits	21	27-33	Maximum of 4 Cr. in lieu of a PE (track B)	48-54

Program Core

COD891	Minor Project	0	0	6	3
COD892	M.Tech. Project Part-I	0	0	14	7
COL702	Advanced Data Structures	3	0	2	4
COL765	Logic & Functional Programming	3	0	2	4
COP701	Software Systems Laboratory	0	0	6	3
Total Credits				21	

Bridge Courses - Min. 6 credits, may be waived in exceptional cases on recommendation by DRC

COL632	Introduction to Data Base Systems	3	0	2	4
COL633	Resources Management in Computer Systems	3	0	2	4
COL671	Artificial Intelligence	3	0	2	4
COL672	Computer Networks	3	0	2	4

Program Electives (PE)

COD893	Major Project Part-II	0	0	28	14
COP820	Processor Design Lab	0	0	8	4
COS799	Independent Study	0	3	0	3

Specialization Streams - At least 6 credits from PE; Project work relevant to specialization

1. Architecture & Embedded Systems (AES)

COL718	Architecture of High Performance Computers	3	0	2	4
COL719	Synthesis of Digital Systems	3	0	2	4
COL720	Real Time Systems	3	0	2	4
COL788	Embedded Computing	3	0	0	3
COL812	System Level Design and Modelling	3	0	0	3
COL818	Principles of Multiprocessor Systems	3	0	2	4
COL821	Reconfigurable Computing	3	0	0	3
COL861	Special Topics in Hardware Systems	3	0	0	3
COP745	Digital System Design Laboratory	0	0	6	3
COP820	Processor Design Lab	0	0	8	4
COV881	Special Module in Hardware Systems	1	0	0	1

2. Graphics & Vision (GV)

COL726	Numerical Algorithms	3	0	2	4
COL780	Computer Vision	3	0	2	4
COL781	Computer Graphics	3	0	3	4.5
COL783	Digital Image Analysis	3	0	3	4.5
COL829	Advanced Computer Graphics	3	0	2	4
COV877	Special Module on Visual Computing	1	0	0	1
SIL801	Special Topics in Multimedia Systems	3	0	0	3

3. Software Systems (SS)

COL720	Real Time Systems	3	0	2	4
COL724	Advanced Computer Networks	3	0	2	4
COL728	Compiler Design	3	0	3	4.5
COL729	Compiler Optimization	3	0	3	4.5
COL730	Parallel Programming	3	0	2	4
COL732	Virtualization and Cloud Computing	3	0	2	4
COL733	Cloud Computing Technology Fundamentals	3	0	2	4
COL740	Software Engineering	3	0	2	4
COL750	Foundations of Automatic Verification	3	0	2	4
COL768	Wireless Networks	3	0	2	4
COL818	Principles of Multiprocessor Systems	3	0	2	4
COL819	Advanced Distributed Systems	3	0	2	4
COL851	Special Topics in Operating Systems	3	0	0	3
COL852	Special Topics in Compilers	3	0	0	3
COL860	Special Topics in Parallel Computation	3	0	0	3
COL862	Special Topics in Software Systems	3	0	0	3
COL867	Special Topics in High Speed Networks	3	0	0	3
COL869	Special Topics in Concurrency	3	0	0	3
COL871	Special Topics in Programming Languages	3	0	0	3
COL874	Special Topics in Compilers and Language Implementation	3	0	0	3
COL876	Special Topics in Formal Methods	3	0	0	3
COL886	Special Topics in Operating Systems	3	0	0	3

COV880	Special Module in Parallel Computation	1	0	0	1
COV882	Special Module in Software Systems	1	0	0	1
COV887	Special Module in High Speed Networks	1	0	0	1
COV889	Special Module in Concurrency	1	0	0	1
SIL765	Networks & System Security	3	0	2	4
SIL769	Internet Traffic - Measurement, Modeling & Analysis	3	0	2	4

4. Theoretical Computer Science (TH)

COL869	Special Topics in Concurrency	3	0	0	3
COL703	Logic for CS (LCS)	3	0	2	4
COL726	Numerical Algorithms	3	0	2	4
COL750	Foundations of Automatic Verification	3	0	2	4
COL751	Algorithmic Graph Theory	3	0	0	3
COL752	Geometric Algorithms	3	0	2	4
COL753	Complexity Theory	3	0	0	3
COL754	Approximation Algorithms	3	0	0	3
COL756	Mathematical Programming	3	0	0	3
COL757	Model Centric Algorithm Design	3	0	2	4
COL758	Advanced Algorithms	3	0	2	4
COL759	Cryptography & Computer Security	3	0	0	3
COL830	Distributed Computing	3	0	0	3
COL831	Semantics of Programming Languages	3	0	0	3
COL832	Proofs and Types	3	0	0	3
COL860	Special Topics in Parallel Computation	3	0	0	3
COL863	Special Topics in Theoretical Computer Science	3	0	0	3
COL866	Special Topics in Algorithms	3	0	0	3
COL869	Special Topics in Concurrency	3	0	0	3
COL871	Special Topics in Programming Languages	3	0	0	3
COL872	Special Topics in Cryptography	3	0	0	3
COL874	Special Topics in Compilers and Language Implementation	3	0	0	3
COL876	Special Topics in Formal Methods	3	0	0	3
COV879	Special Module in Financial Algorithms	2	0	0	2
COV883	Special Module in Theoretical Computer Science	1	0	0	1
COV886	Special Module in Algorithms	1	0	0	1
COV889	Special Module in Concurrency	1	0	0	1

5. Data Analytics & AI (DAAI)

COL726	Numerical Algorithms	3	0	2	4
COL760	Advanced Data Management	3	0	2	4
COL761	Data Mining	3	0	2	4
COL762	Database Implementation	3	0	2	4
COL764	Information Retrieval and Web Search	3	0	2	4
COL770	Advanced Artificial Intelligence	3	0	2	4
COL772	Natural Language Processing	3	0	2	4
COL774	Machine Learning	3	0	2	4
COL776	Learning Probabilistic Graphical Models	3	0	2	4
COL786	Advanced Functional Brain Imaging	3	0	2	4
COL864	Special Topics in Artificial Intelligence	3	0	0	3
COL868	Special Topics in Database Systems	3	0	0	3
COL870	Special Topics in Machine Learning	3	0	0	3
COL873	Special Topics in Natural Language Processing	3	0	0	3
COV878	Special Module in Machine Learning	1	0	0	1
COV884	Special Module in Artificial Intelligence	1	0	0	1
COV888	Special Module in Database Systems	1	0	0	1

6. Applications & IT (ITA)

COL722	Introduction to Compressed Sensing	3	0	0	3
COL757	Model Centric Algorithm Design	3	0	2	4
COL760	Advanced Data Management	3	0	2	4
COL761	Data Mining	3	0	2	4
COL762	Database Implementation	3	0	2	4
COL764	Information Retrieval and Web Search	3	0	2	4
COL770	Advanced Artificial Intelligence	3	0	2	4
COL786	Advanced Functional Brain Imaging	3	0	2	4

COL865	Special Topics in Computer Applications	3	0	0	3	SIL861	Special Topics in Information & Communication Technologies for Development	3	0	0	3
COV885	Special Module in Computer Applications	1	0	0	1	SIV813	Applications of Computer in Medicines	1	0	0	1
COV888	Special Module in Database Systems	1	0	0	1	SIV861	Information and Communication Technologies for Development	1	0	0	1
SIL761	Introduction to Information and Communication Technologies for Development	3	0	2	4	SIV864	Special Module on Media Processing Communication	1	0	0	1
SIL763	Introduction to Blockchains	3	0	2	4	SIV871	Special Module in Computational Neuroscience	1	0	0	1
SIL769	Internet Traffic - Measurement, Modeling & Analysis	3	0	2	4	SIV895	Special Module on Intelligent Information Processing	1	0	0	1
SIL801	Special Topics in Multimedia	3	0	0	3						
SIL802	Special Topics in Web Based Computing	3	0	0	3						

Sem.	Courses (Number, Abbreviated Title, L-T-P, credits)					Lecture courses	Contact h/week				Credits
	L	T	P	Total							
I	COL702 Advanced Data Structures (3-0-2) 4	Bridge Course-1 (3-4)	COL765 Logic and Functional Programming (3-0-2) 4	COP701 Software Lab (0-0-6) 3		2-3	6-9	0	10-12	16-21	11-15
II	PE-1 (3-4)	Bridge Course-2 (3-4)	COD891 Minor Project (0-0-6) 3	PE-2 (3-4)		2-3	6-9	0	10-12	16-21	9-15
Track A (Requires a CGPA of atleast 7.25 after completing at least 20 credits of course work, eligible for specializations)											
III	PE-3 (3-4)	PE-4 (3-4)	COD892 M.Tech. Project Part-I (0-0-14) 7			2	6	0	14-18	20-24	13-15
IV	COD893 M.Tech. Project Part-II (MTP-II) (0-0-28) 14 Continued in the summer					0	0	0	28	28	14
Track B (Student needs an approval from a committee to enter this track if CGPA >= 7.25, not eligible for specializations)											
III	PE-3 (3-4)	PE-4 (3-4)	PE-5/OC (3-4)			3	9	0	0-6	9-15	9-12
IV	PE-6 (3-4)	PE-7 (3-4)	COD892 M.Tech. Project Part-I (0-0-14) 7			2	6	0	14-18	20-24	13-15

Total = 48-54

Master of Technology in Control and Automation

Department of Electrical Engineering

The overall credits structure

Category	PC	PE	OE	Total
Credits	24	18	6	48

Program Core

ELD801	Major Project Part-I		0	0	12	6
ELL700	Linear Systems Theory		3	0	0	3
ELL701	Mathematical Methods in Control		3	0	0	3
ELL702	Nonlinear Systems		3	0	0	3
ELL703	Optimal Control Theory		3	0	0	3
ELL705	Stochastic Filtering and Identification		3	0	0	3
ELP800	Control Systems Laboratory		0	0	2	1
ELP801	Advanced Control Laboratory		0	0	4	2
Total Credits						24

Program Electives

ELD800	Minor Project (EEA)		0	0	6	3
ELD802	Major Project Part-II		0	0	24	12
ELL704	Advanced Robotics		3	0	0	3
MTL704	Numerical Optimization		3	0	0	3
ELL707	Systems Biology		3	0	0	3
ELL708	Selected Topics in Systems and Control		3	0	0	3
ELL709	Design Aspects in Control		3	0	0	3
DSL711	Sensors & Transducers		3	0	0	3
ELL714	Basic Information Theory		3	0	0	3
ELL720	Advanced Digital Signal Processing		3	0	0	3
MTL731	Introduction to Chaotic Dynamical System		3	0	0	3
ELL762	Intelligent Motor Controllers		3	0	0	3
ELL765	Smart Grid Technology		3	0	0	3
ELL767	Mechatronics		3	0	0	3
ELL775	Power System Dynamics		3	0	0	3
ELL778	Dynamic Modelling And Control of Sustainable Energy Systems		3	0	0	3

MCL783	Automation Manufacturing		2	0	2	4
ELL784	Introduction to Machine Learning		3	0	0	3
ELL787	Embedded Systems and Applications		3	0	0	3
ELL789	Intelligent Systems		3	0	0	3
ELL791	Neural Systems and Learning Machines		3	0	2	4
ELL793	Computer Vision		3	0	0	3
ELL795	Swarm Intelligence		3	0	0	3
ELL796	Signals and Systems in Biology		3	0	0	3
ELL800	Numerical Linear Algebra and Optimization in Engineering		3	0	0	3
ELL801	Nonlinear Control		3	0	0	3
ELL802	Adaptive and Learning Control		3	0	0	3
ELL803	Model Reduction in Control		3	0	0	3
ELL804	Robust Control		3	0	0	3
ELL805	Networked and Multi-Agent Control Systems		3	0	0	3
ELL806	Modeling and Control of Distributed Parameter Systems		3	0	0	3
ELL807	Stochastic Control		3	0	0	3
ELL808	Advanced Topics in Systems and Control		3	0	0	3
MCL845	Advanced Robotics		2	0	2	3
ELL850	Digital Control of Power Electronics and Drive Systems		3	0	0	3
ELL883	Embedded Intelligence		3	0	0	3
ELL888	Advanced Machine Learning		3	0	0	3
ELL890	Computational Neuroscience		3	0	0	3
ELL893	Cyber-Physical Systems		3	0	0	3
ELV700	Special Module in Systems and Control		1	0	0	1

Sem.	Courses (Number, Abbreviated Title, L-T-P, Credits)					Lecture courses	Contact h/week				Credits
	L	T	P	Total							
I	ELL700 Linear Systems Theory (3-0-0)	ELL701 Mathematical Methods in Control (3-0-0)	ELL702 Nonlinear Systems (3-0-0)	ELP800 Control Systems Lab (0-0-2)	OE (3-0-0)	4	12	0	2	14	13
II	ELL703 Optimal Control Theory (3-0-0)	ELL705 Stochastic Filtering and Identification (3-0-0)	ELP801 Advanced Control Lab (0-0-4)	PE (3-0-0)		3	9	0	4	13	11
Summer											
III (Project based) OR	ELD801 Major Project Part-I (0-0-12)		PE (3-0-0)	OE (3-0-0)		2	6	0	12	18	12
III (Course based)	PE (3-0-0)	PE (3-0-0)	PE (3-0-0)	OE (3-0-0)		4	12	0	0	12	12
IV (Project based) OR	ELD802 Major Project Part-II (0-0-24)					0	0	0	24	24	12
IV (Course based)	ELD801 Major Project Part-I (0-0-12)		PE (3-0-0)	PE (3-0-0)		2	6	0	12	18	12

Total = 48

Master of Technology in Communication Engineering

Department of Electrical Engineering

The overall credits structure

Category	PC	PE	OE	Total
Credits	24	18	6	48

Program Core

ELD811	Major Project Part-I (Communication Engineering)	0	0	12	6
ELL711	Signal Theory	3	0	0	3
ELL712	Digital Communications	3	0	0	3
ELL713	Microwave Theory and Techniques	3	0	0	3
ELL719	Detection and Estimation Theory	3	0	0	3
ELP719	Microwave Laboratory	0	1	4	3
ELP725	Wireless Communication Laboratory	0	1	4	3
Total Credits				24	

Program Electives

BSP710	Communication & Signal Processing Tech. Lab.	0	1	4	3
--------	--	---	---	---	---

Streamed Electives (EEE) in (Communication Systems)

BSP710	Communication & Signal Processing Tech. Lab.	0	1	4	3
ELD810	Minor Project (Communication Engineering)	0	0	6	3
ELD812	Major Project Part-II	0	0	24	12
ELL701	Mathematical Methods in Control	3	0	0	3
ELL710	Coding Theory	3	0	0	3
ELL714	Basic Information Theory	3	0	0	3
ELL716	Telecommunication Switching and Transmission	3	0	0	3
ELL717	Optical Communication Systems	3	0	0	3
ELL720	Advanced Digital Signal Processing	3	0	0	3
ELL722	Antenna Theory and Techniques	3	0	0	3
ELL723	Broadband Communication Systems	3	0	0	3
ELL724	Computational Electromagnetics	3	0	0	3
ELL725	Wireless Communications	3	0	0	3
ELL730	I.C. Technology	3	0	0	3
ELL732	Micro and Nanoelectronics	3	0	0	3
ELL734	MOS VLSI design	3	0	0	3
ELL735	Analog Integrated Circuits	3	0	0	3
ELL785	Computer Communication Networks	3	0	0	3
ELL810	Cyber Security and Information Assurance	3	0	0	3
ELL812	Microwave Propagation and Systems	3	0	0	3
ELL813	Advanced Information Theory	3	0	0	3
ELL814	Wireless Optical Communications	3	0	0	3
ELL815	MIMO Wireless Communications	3	0	0	3
ELL816	Satellite Communication	3	0	0	3
ELL818	Telecommunication Technologies	3	0	0	3

ELL821	Selected Topics in Communication Systems and Networking-I	3	0	0	3
ELL822	Selected Topics in Communication Systems and Networking-II	3	0	0	3
ELL833	CMOS RF IC Design	3	0	0	3
ELL894	Network Performance Modeling and Analysis	3	0	0	3
ELP718	Telecommunication Software Laboratory	0	1	4	3
ELP721	Embedded Telecommunication Systems Laboratory	0	1	4	3
ELV710	Special Module in Cyber Security	1	0	0	1
ELV720	Special Module in Communication Systems and Networking-I	1	0	0	1
ELV821	Special Module in Communication Systems and Networking-II	1	0	0	1
CRL708	Sonar Systems Engineering	3	0	0	3
CRL709	Underwater Electronic Systems	3	0	0	3
CRL712	RF and Microwave Active Circuits	3	0	0	3
CRL715	Radiating Systems for RF Communication	3	0	0	3

Streamed Electives (EEE) in (Information Processing)

ELD810	Minor Project (Communication Engineering)	0	0	6	3
ELD812	Major Project Part-II	0	0	24	12
ELL701	Mathematical Methods in Control	3	0	0	3
ELL714	Basic Information Theory	3	0	0	3
ELL715	Digital Image Processing	3	0	2	4
ELL718	Statistical Signal Processing	3	0	0	3
ELL720	Advanced Digital Signal Processing	3	0	0	3
ELL784	Introduction to Machine Learning	3	0	0	3
ELL786	Multimedia Systems	3	0	0	3
ELL792	Computer Graphics	3	0	0	3
ELL793	Computer Vision	3	0	0	3
ELL794	Human-Computer Interface	3	0	0	3
ELL823	Selected Topics in Information Processing-I	3	0	0	3
ELL824	Selected Topics in Information Processing-II	3	0	0	3
ELV781	Special Modules in Information Processing-I	1	0	0	1
ELV823	Special Modules in Information Processing-II	1	0	0	1
CRL704	Sensor Array Signal Processing	3	0	0	3
CRL707	Human & Machine Speech Communication	3	0	0	3

Sem.	Courses (Number, Abbreviated Title, L-T-P, credits)					Lecture courses	Contact h/week				Credits
	L	T	P	Total							
I	ELL 711 Signal theory (3-0-0)	ELL712 Digital Comm. (3-0-0)	ELL 713 Microwave Theory and Techniques (3-0-0)	ELP 719 Microwave Lab. (0-1-4)		3	9	1	4	14	12
II	ELL719 Detection and Estimation Theory (3-0-0)	ELP725 Wireless Comm. Lab. (0-1-4)	PE-1 (3-0-0)	PE-2 (3-0-0)		3	9	1	4	14	12
Summer											
III	ELD811 Major Project Part-I (0-0-12) 6		OE-1 (3-0-0)	OE-2 (3-0-0)		2	6	0	12	18	12
IV (Project based) OR	ELD812 Major Project Part-II (0-0-24) 12					0	0	0	24	24	12
IV (Course based)	PE-3 (3-0-0)	PE-4 (3-0-0)	PE-5 (3-0-0)	PE-6 (3-0-0)		4	12	0	0	12	12

Total = 48

Master of Technology in Integrated Electronics and Circuits

Department of Electrical Engineering

The overall credits structure

Category	PC	PE	OC	Total
Credits	24	18	6	48

Program Core

ELD831	Major Project Part-I (Integrated Electronic Circuits)		0	0	12	6
ELL730	I.C. Technology		3	0	0	3
ELL732	Micro and Nanoelectronics		3	0	0	3
ELL734	MOS VLSI design		3	0	0	3
ELL735	Analog Integrated Circuits		3	0	0	3
ELP831	IEC Laboratory-I		0	0	6	3
ELP832	IEC Laboratory-II		0	0	6	3
Total Credits			24			

ELL737	Flexible Electronics		3	0	0	3
ELL738	Micro and Nano Photonics		3	0	0	3
ELL739	Advanced Semiconductor Devices		3	0	0	3
ELL740	Compact Modeling of Semiconductor Devices		3	0	0	3
ELL741	Neuromorphic Engineering		3	0	0	3
ELL742	Introduction to MEMS Design		3	0	0	3
ELL743	Photovoltaics		3	0	0	3
ELL744	Electronic and Photonic Nanomaterials		3	0	0	3
ELL745	Quantum Electronics		3	0	0	3
ELL746	Biomedical Electronics		3	0	0	3
ELL749	Semiconductor Memory Design		3	0	0	3
ELL791	Neural Systems and Learning Machines		3	0	2	4
ELL830	Issues in Deep Submicron VLSI Design		3	0	0	3
ELL832	Selected Topics in IEC-I		3	0	0	3
ELL834	Selected Topics in IEC-II		3	0	0	3
ELP830	Semiconductor Processing Laboratory		0	0	6	3
ELP833	Device and Materials Characterization Lab.		0	0	6	3
ELV734	Special Module in Scientific Writing for Research		1	0	0	1
ELV833	Special Module in Semiconductor Business Management		1	0	0	1
ELV834	Special Module in Nanoelectronics		1	0	0	1

Program Electives

BSP710	Communication & Signal Processing Tech. Lab.		0	1	4	3
--------	--	--	---	---	---	---

Streamed Electives (EEN) in (VLSI Design)

COL719	Synthesis of Digital Systems		3	0	2	4
ELD830	Minor Project		0	0	6	3
ELD832	Major Project Part-II		0	0	24	12
ELL720	Advanced Digital Signal Processing		3	0	0	3
ELL731	Mixed Signal Circuit Design		3	0	0	3
ELL733	Digital ASIC Design		3	0	2	4
ELL736	Solid State Imaging Sensors		3	0	0	3
ELL737	Flexible Electronics		3	0	0	3
ELL740	Compact Modeling of Semiconductor Devices		3	0	0	3
ELL741	Neuromorphic Engineering		3	0	0	3
ELL747	Active and Passive Filter Design		3	0	0	3
ELL748	System-on-Chip Design and Test		3	0	0	3
ELL749	Semiconductor Memory Design		3	0	0	3
ELL782	Computer Architecture		3	0	0	3
ELL791	Neural Systems and Learning Machines		3	0	2	4
ELL830	Issues in Deep Submicron VLSI Design		3	0	0	3
ELL831	CAD for VLSI, MEMS, and Nanoassembly		3	0	0	3
ELL832	Selected Topics in IEC-I		3	0	0	3
ELL833	CMOS RF IC Design		3	0	0	3
ELL834	Selected Topics in IEC-II		3	0	0	3
ELP830	Semiconductor Processing Laboratory		0	0	6	3
ELV734	Special Module in Scientific Writing for Research		1	0	0	1
ELV830	Special Module in Low Power IC Design		1	0	0	1
ELV831	Special Module in VLSI Testing		1	0	0	1
ELV832	Special Module in Machine Learning		1	0	0	1

Streamed Electives (EEN) in (Embedded Intelligent Systems)

COL719	Synthesis of Digital Systems		3	0	2	4
COL788	Advanced Topics in Embedded Computing		3	0	0	3
ELD830	Minor Project		0	0	6	3
ELD832	Major Project Part-II		0	0	24	12
ELL720	Advanced Digital Signal Processing		3	0	0	3
ELL731	Mixed Signal Circuit Design		3	0	0	3
ELL733	Digital ASIC Design		3	0	2	4
ELL736	Solid State Imaging Sensors		3	0	0	3
ELL748	System-on-Chip Design and Test		3	0	0	3
ELL782	Computer Architecture		3	0	0	3
ELL784	Introduction to Machine Learning		3	0	0	3
ELL787	Embedded Systems and Applications		3	0	0	3
ELL789	Intelligent Systems		3	0	0	3
ELL791	Neural Systems and Learning Machines		3	0	2	4
ELL830	Issues in Deep Submicron VLSI Design		3	0	0	3
ELL831	CAD for VLSI, MEMS, and Nanoassembly		3	0	0	3
ELL832	Selected Topics in IEC-I		3	0	0	3
ELL834	Selected Topics in IEC-II		3	0	0	3
ELL883	Embedded Intelligence		3	0	0	3
ELV734	Special Module in Scientific Writing for Research		1	0	0	1
ELV831	Special Module in VLSI Testing		1	0	0	1
ELV832	Special Module in Machine Learning		1	0	0	1

Streamed Electives (EEN) in (Nanoelectronics and Photonics)

ELD830	Minor Project		0	0	6	3
ELD832	Major Project Part-II		0	0	24	12

Sem.	Courses (Number, Abbreviated Title, L-T-P, Credits)					Lecture courses	Contact h/week				Credits
	L	T	P	Total	L		T	P	Total		
I	ELL732 Micro and Nanoelectronics (3-0-0)	ELL735 Analog Integrated Circuits (3-0-0)	ELL734 MOS VLSI Design (3-0-0)	ELP831 IEC Lab-I (0-0-6)		3	9	0	6	15	12
II	PE (3-0-0)	ELP832 IEC Lab-II (0-0-6)	ELL730 I.C. Technology (3-0-0)	PE/OE (3-0-0)		3	9	0	6	15	12
Summer											
III	ELD831 Major Project Part-I (0-0-12)		PE/OE (3-0-0)	PE/OE (3-0-0)		2	6	0	12	18	12
IV (Project based) OR	ELD832 Major Project Part-II (0-0-24)					0	0	0	24	24	12
IV (Course based)	PE/OE (3-0-0)	PE/OE (3-0-0)	PE/OE (3-0-0)	PE/OE (3-0-0)		4	12	0	0	12	12

Total = 48

Master of Technology in Power Electronics, Electrical Machines and Drives

Department of Electrical Engineering

The overall credits structure

Category	PC	PE	OC	Total
Credits	24	18	6	48

Program Core

ELD851	Major Project Part-I	0	0	12	6
ELL750	Modelling of Electrical Machines	3	0	0	3
ELL751	Power Electronic Converters	3	0	0	3
ELL752	Electric Drive System	3	0	0	3
ELL850	Digital Control of Power Electronics and Drive Systems	3	0	0	3
ELP850	Electrical Machines Laboratory	0	0	3	1.5
ELP851	Power Electronics Laboratory	0	0	3	1.5
ELP852	Electrical Drives Laboratory	0	0	3	1.5
ELP853	DSP Based Control of Power Electronics and Drives Laboratory	0	0	3	1.5

Total Credits

24

Program Electives

ELD850	Minor Project	0	0	6	3
ELD852	Major Project Part-II	0	0	24	12
ELL700	Linear Systems Theory	3	0	0	3
ELL703	Optimal Control Theory	3	0	0	3
ELL704	Advanced Robotics	3	0	0	3
ELL706	Digital Control	3	0	0	3
ELL720	Advanced Digital Signal Processing	3	0	0	3
ELL753	Physical Phenomena in Electrical Machines	3	0	0	3
ELL754	Permanent Magnet Machines	3	0	0	3
ELL755	Variable Reluctance Machines	3	0	0	3
ELL756	Special Electrical Machines	3	0	0	3
ELL757	Energy Efficient Motors	3	0	0	3

ELL758	Power Quality	3	0	0	3
ELL759	Power Electronic Converters for Renewable Energy Systems	3	0	0	3
ELL760	Switched Mode Power Conversion	3	0	0	3
ELL761	Power Electronics for Utility Interface	3	0	0	3
ELL762	Intelligent Motor Controllers	3	0	0	3
ELL763	Advanced Electric Drives	3	0	0	3
ELL764	Electric Vehicles	3	0	0	3
ELL765	Smart Grid Technology	3	0	0	3
ELL766	Appliance Systems	3	0	0	3
ELL767	Mechatronics	3	0	0	3
ELL768	Computer Aided Design of Power Electronic Systems	3	0	0	3
ELL787	Embedded Systems and Applications	3	0	0	3
ELL791	Neural Systems and Learning Machines	3	0	2	4
ELL851	Computer Aided Design of Electrical Machines	3	0	0	3
ELL852	Condition Monitoring of Electrical Machines	3	0	0	3
ELL853	Advanced Topics in Electrical Machines	3	0	0	3
ELL854	Selected Topics in Electrical Machines	3	0	0	3
ELL855	High Power Converters	3	0	0	3
ELL856	Advanced Topics in Power Electronics	3	0	0	3
ELL857	Selected Topics in Power Electronics	3	0	0	3
ELL858	Advanced Topics in Electric Drives	3	0	0	3
ELL859	Selected Topics in Electric Drives	3	0	0	3
ELP854	Electrical Machines CAD Laboratory	0	1	4	3
ELP855	Smart Grids Laboratory	0	1	4	3
ELT850	Industrial Training and Seminar	0	0	6	3

Sem.	Courses (Number, Abbreviated Title, L-T-P, Credits)					Lecture courses	Contact h/week				Credits
	L	T	P	Total							
I	ELL750 Modelling of Electrical Machines (3-0-0)	ELL751 Power Electronic Converters (3-0-0)	ELP850 Electrical Machines Laboratory (0-0-3)	ELP851 Power Electronics Laboratory (0-0-3)	PE/OE (3-0-0)*	3	9	0	6	15	12
II	ELL752 Electric Drive System (3-0-0)	ELL850 Digital Control of Power Electronics and Drive Systems (3-0-0)	ELP852 Electrical Drives Laboratory (0-0-3)	ELP853 DSP Based Control of Power Electronics and Drives Laboratory (0-0-3)	PE/OE (3-0-0)*	3	9	0	6	15	12
Project Based											
III	ELD851 Major Project Part-I (0-0-12)	PE/OE (3-0-0)*	PE/OE (3-0-0)*			2	6	0	12	18	12
IV	ELD852 Major Project Part-II (0-0-24)					0	0	0	24	24	12
(OR) Course Based											
III	PE/OE (3-0-0)	PE/OE (3-0-0)	PE/OE (3-0-0)	PE/OE (3-0-0)		4	12	0	0	12	12
IV	ELD851 Major Project Part-I (0-0-12)	PE/OE (3-0-0)	PE/OE (3-0-0)			2	6	0	12	18	12

Total = 48

Master of Technology in Power Systems

Department of Electrical Engineering

The overall credits structure

Category	PC	PE	OC	Total
Credits	24	18	6	48

Program Core

ELD871	Major Project Part-I	0	0	12	6
ELL770	Power System Analysis	3	0	0	3
ELL771	Advanced Power System Protection	3	0	0	3
ELL775	Power System Dynamics	3	0	0	3
ELL776	Advanced Power System Optimization	3	0	0	3
ELP870	Power System Lab-I	0	1	4	3
ELP871	Power System Lab-II	0	1	4	3
Total Credits				24	

ELL758	Power Quality	3	0	0	3
ELL759	Power Electronic Converters for Renewable Energy Systems	3	0	0	3
ELL772	Planning and Operation of a Smart Grid	3	0	0	3
ELL773	High Voltage DC Transmission	3	0	0	3
ELL774	Flexible AC Transmission System	3	0	0	3
ELL777	Power System operation and control	3	0	0	3
ELL778	Dynamic Modelling And Control of Sustainable Energy Systems	3	0	0	3
ELL779	Forecasting Techniques for Power System	3	0	0	3
ELL870	Restructured Power System	3	0	0	3
ELL871	Distribution System Operation and Planning	3	0	0	3
ELL872	Selected Topics in Power System	3	0	0	3
ELL873	Power System Transient	3	0	0	3
ELL874	Power System Reliability	3	0	0	3

Program Electives

ELD870	Minor Project-I	0	0	6	3
ELD872	Major Project Part-II	0	0	24	12
ELL700	Linear Systems Theory	3	0	0	3
ELL712	Digital Communications	3	0	0	3

Sem.	Courses (number, Abbreviated Title, L-T-P, Credits)					Lecture courses	Contact h/week				Credits
							L	T	P	Total	
I	ELL 770 Power System Analysis (3-0-0)	ELL771 Advanced Power System Protection (3-0-0)	ELL775 Power System Dynamics (3-0-0)	ELP870 Power System Lab-I (0-1-4)		3	9	1	4	14	12
II	ELL776 Advanced Power System Optimization (3-0-0)	ELP871 Power System Lab-II (0-1-4)	PE/OE (3-0-0)	PE/OE (3-0-0)		3	9	1	4	14	12
Summer											
III	ELD871 Major Project Part-I (0-0-12)		PE/OE (3-0-0)	PE/OE (3-0-0)		2	6	0	12	18	12
IV (Project based) OR	ELD871 Major Project Part-II (0-0-24)					0	0	0	24	24	12
IV (Course based)	PE/OE (3-0-0)	PE/OE (3-0-0)	PE/OE (3-0-0)	PE/OE (3-0-0)		4	12	0	0	12	12

Total = 48

Master of Technology in Computer Technology

Department of Electrical Engineering

The overall credits structure

Category	PC	PE	OC	Total
Credits	21	24/27	3/6	51

Program Core

ELD780	Minor Project		0	0	4	2
ELD880	Major Project Part-I		0	0	12	6
ELL780	Mathematical Foundations of Computer Technology		3	0	0	3
ELL781	Software Fundamentals for Computer Technology		3	0	0	3
ELL782	Computer Architecture		3	0	0	3
ELL783	Operating Systems		3	0	2	4
Total Credits					21	

Program Electives

BSP710	Communication & Signal Processing Tech. Lab.		0	1	4	3
ELD881	Major Project Part-II		0	0	24	12
ELL880	Special Topics in Computers-I		3	0	0	3
ELL881	Special Topics in Computers-II		3	0	0	3
ELV752	Special Modules in EET – I		1	0	0	1
ELV780	Special Module in Computers		1	0	0	1

Streamed Electives (EET) in (Cognitive and Intelligent Systems)

Required Electives

ELL784	Introduction to Machine Learning		3	0	0	3
ELL786	Multimedia Systems		3	0	0	3

Other Electives

ELL704	Advanced Robotics		3	0	0	3
ELL707	Systems Biology		3	0	0	3
ELL715	Digital Image Processing		3	0	2	4
ELL741	Neuromorphic Engineering		3	0	0	3
ELL785	Computer Communication Networks		3	0	0	3
ELL787	Embedded Systems and Applications		3	0	0	3
ELL788	Computational Perception and Cognition		3	0	0	3
ELL789	Intelligent Systems		3	0	0	3
ELL791	Neural Systems and Learning Machines		3	0	2	4
ELL793	Computer Vision		3	0	0	3
ELL794	Human-Computer Interface		3	0	0	3
ELL795	Swarm Intelligence		3	0	0	3
ELL796	Signals and Systems in Biology		3	0	0	3
ELL798	Agent Technologies		3	0	0	3
ELL799	Natural Computing		3	0	0	3
ELL882	Large-Scale Machine Learning		3	0	0	3
ELL883	Embedded Intelligence		3	0	0	3
ELL884	Information Retrieval		3	0	0	3
ELL885	Machine Learning for Computational Finance		3	0	0	3
ELL886	Big Data Systems		3	0	0	3
ELL887	Cloud Computing		3	0	0	3
ELL888	Advanced Machine Learning		3	0	0	3
ELL890	Computational Neuroscience		3	0	0	3
ELL891	Computational Linguistics		3	0	0	3
ELL893	Cyber-Physical Systems		3	0	0	3

Streamed Electives (EET) in (Embedded Intelligent Systems)

Required Electives

ELL784	Introduction to Machine Learning		3	0	0	3
ELL787	Embedded Systems and Applications		3	0	0	3

Other Electives

COL719	Synthesis of Digital Systems		3	0	2	4
COL812	System Level Design and Modelling		3	0	0	3
ELL704	Advanced Robotics		3	0	0	3
ELL710	Coding Theory		3	0	0	3
ELL720	Advanced Digital Signal Processing		3	0	0	3
ELL728	Optoelectronic Instrumentation		3	0	0	3
ELL731	Mixed Signal Circuit Design		3	0	0	3
ELL733	Digital ASIC Design		3	0	2	4
ELL734	MOS VLSI design		3	0	0	3

ELL735	Analog Integrated Circuits		3	0	0	3
ELL748	System-on-Chip Design and Test		3	0	0	3
ELL766	Appliance Systems		3	0	0	3
ELL767	Mechatronics		3	0	0	3
ELL785	Computer Communication Networks		3	0	0	3
ELL786	Multimedia Systems		3	0	0	3
ELL790	Digital Hardware Design		3	0	0	3
ELL791	Neural Systems and Learning Machines		3	0	2	4
ELL797	Energy-Efficient Computing		3	0	0	3
ELL802	Adaptive and Learning Control		3	0	0	3
ELL883	Embedded Intelligence		3	0	0	3
ELL887	Cloud Computing		3	0	0	3
ELL898	Pervasive Computing		3	0	0	3
ELL899	Testing and Fault Tolerance		3	0	0	3
ELP780	Software Lab		0	1	4	3
ELP781	Digital Systems Lab		0	1	4	3
ELP831	IEC Laboratory-I		0	0	6	3

Streamed Electives (EET) in (Computer Communication and Networks)

Required Electives

ELL785	Computer Communication Networks		3	0	0	3
ELL786	Multimedia Systems		3	0	0	3

Other Electives

ELL710	Coding Theory		3	0	0	3
ELL711	Signal Theory		3	0	0	3
ELL712	Digital Communications		3	0	0	3
ELL714	Basic Information Theory		3	0	0	3
ELL716	Telecommunication Switching and Transmission		3	0	0	3
ELL717	Optical Communication Systems		3	0	0	3
ELL723	Broadband Communication Systems		3	0	0	3
ELL725	Wireless Communications		3	0	0	3
ELL784	Introduction to Machine Learning		3	0	0	3
ELL787	Embedded Systems and Applications		3	0	0	3
ELL797	Energy-Efficient Computing		3	0	0	3
ELL813	Advanced Information Theory		3	0	0	3
ELL816	Satellite Communication		3	0	0	3
ELL817	Access Networks		3	0	0	3
ELL818	Telecommunication Technologies		3	0	0	3
ELL820	Photonic Switching and Networking		3	0	0	3
ELL887	Cloud Computing		3	0	0	3
ELL889	Protocol Engineering		3	0	0	3
ELL892	Internet Technologies		3	0	0	3
ELL894	Network Performance Modeling and Analysis		3	0	0	3
ELL895	Network Security		3	0	0	3
ELL896	Mobile Computing		3	0	0	3
ELL897	Network Management		3	0	0	3
ELL898	Pervasive Computing		3	0	0	3
ELP720	Telecommunication Networks Laboratory		0	1	4	3
ELP780	Software Lab		0	1	4	3
ELP781	Digital Systems Lab		0	1	4	3
ELP782	Computer Networks Lab		0	1	4	3
ELP821	Advanced Telecommunication Networks Laboratory		0	1	4	3
ELP822	Network Software Laboratory		0	1	4	3

Streamed Electives (EET) in (Multimedia Information Processing)

Required Electives

ELL786	Multimedia Systems		3	0	0	3
ELL787	Embedded Systems and Applications		3	0	0	3

Other Electives

ELL710	Coding Theory		3	0	0	3
--------	---------------	--	---	---	---	---

ELL711	Signal Theory	3	0	0	3
ELL714	Basic Information Theory	3	0	0	3
ELL715	Digital Image Processing	3	0	2	4
ELL718	Statistical Signal Processing	3	0	0	3
ELL719	Detection and Estimation Theory	3	0	0	3
ELL720	Advanced Digital Signal Processing	3	0	0	3
ELL784	Introduction to Machine Learning	3	0	0	3
ELL785	Computer Communication Networks	3	0	0	3
ELL788	Computational Perception and Cognition	3	0	0	3
ELL792	Computer Graphics	3	0	0	3
ELL793	Computer Vision	3	0	0	3
ELL813	Advanced Information Theory	3	0	0	3
ELL882	Large-Scale Machine Learning	3	0	0	3
CRL707	Human & Machine Speech Communication	3	0	0	3

Other Electives

ELL723	Broadband Communication Systems	3	0	0	3
ELL765	Smart Grid Technology	3	0	0	3
ELL766	Appliance Systems	3	0	0	3
ELL772	Planning and Operation of a Smart Grid	3	0	0	3
ELL786	Multimedia Systems	3	0	0	3
ELL787	Embedded Systems and Applications	3	0	0	3
ELL797	Energy-Efficient Computing	3	0	0	3
ELL798	Agent Technologies	3	0	0	3
ELL884	Information Retrieval	3	0	0	3
ELL887	Cloud Computing	3	0	0	3
ELL892	Internet Technologies	3	0	0	3
ELL895	Network Security	3	0	0	3
ELL896	Mobile Computing	3	0	0	3
ELL898	Pervasive Computing	3	0	0	3
ELP721	Embedded Telecommunication Systems Laboratory	0	1	4	3
ELP780	Software Lab	0	1	4	3
ELP781	Digital Systems Lab	0	1	4	3
ELP782	Computer Networks Lab	0	1	4	3
ELP855	Smart Grids Laboratory	0	1	4	3

Streamed Electives (EET) in (Internet Technologies)

Required Electives

ELL784	Introduction to Machine Learning	3	0	0	3
ELL785	Computer Communication Networks	3	0	0	3

Sem.	Courses (Number, Abbreviated Title, L-T-P, Credits)					Lecture courses	Contact h/week				Credits
	L	T	P	Total							
I	ELL780 Mathematical Foundations of Computer Technology (3-0-0)	ELL781 Software Fundamentals for Computer Technology (3-0-0)	ELL782 Computer Architecture (3-0-0)	PE-1 (3-0-0)	PE-2 (3-0-0)	5	15	0	0	15	15
II	ELL783 Operating Systems (3-0-2)	ELD780 Minor Project (0-0-4)	PE-3 (3-0-0)	PE-4 (3-0-0)		4	9	0	6	15	12
Summer: [PC-6] ELD880 Major Project Part 1 (for M.Tech with Dissertation)											
III (M.Tech. with Dissertation) OR	ELD880 Major Project Part-I (0-0-12)	PE-5 (3-0-0)	OE-1 (3-0-0)			2	6	0	12	18	12
III (M.Tech. without Dissertation)	PE-5 (3-0-0)	PE-6 (3-0-0)	PE-7/OE-1 (3-0-0)	PE-8/OE-2 (3-0-0)		4	12	0	0	12	12
IV (M.Tech. with Dissertation) OR	ELD881 Major Project Part-II (0-0-24)					0	0	0	24	24	12
IV (M.Tech. without Dissertation)	ELD880 Major Project Part-I (0-0-12)	PE-7/OE-1 (3-0-0)	PE-8/OE-2 (3-0-0)			2	6	0	12	18	12

Total = 51

Master of Technology in Materials Engineering

Department of Materials Science and Engineering

The overall credits structure

Category	PC	PE	OE/PE	RE	Total
Credits	32	06	06	04	48

Program Core

MLL701	Structure and Characterization of Materials	3	0	0	3
MLL702	Thermodynamics of Materials	3	0	0	3
MLL703	Mathematical and Computational Methods in Materials	3	0	2	4
MLP704	Materials Processing and Characterization Lab	1	1	4	4
MLD801	M.Tech. Project I	0	0	18	9
MLD802	M.Tech. Project II	0	0	18	9
Total Credits				32	

Program Electives (PE)

MLL712/					
APL753	Materials Design and Selection	3	0	0	3
MLL713	Phase Transformations	3	0	0	3
MLL714	Fracture Mechanics	3	0	0	3
MLL715	Advanced Engineering Materials	3	0	0	3
MLL716/					
APL767	Engineering Failure Analysis and Prevention	3	0	0	3
MLL717	Engineering and Specialty Polymers	3	0	0	3
MLL718	Polymeric Nanomaterials and Nanocomposites	3	0	0	3
MLL727	Smart Polymeric Materials	3	0	0	3
MLL748	Solid State Diffusion and Kinetics	3	0	0	3
MLL750	Imperfections in Materials and Applications	3	0	0	3
MLL752	Creep and Superplasticity of Materials	3	0	0	3
MLL760	Materials Simulation Methods Using High Performance Computing	3	0	0	3

Non-graded Core (NG)

MLN710	Research Seminar	0	0	2	1
--------	------------------	---	---	---	---

Restricted Elective (RE) or Stream Core

MLV705	Special Topics in Materials	1	0	0	1
MLL711	Mechanical Behaviour of Materials	3	0	0	3

Sem.	Courses (Number, Abbreviated Title, L-T-P, credits)					Lecture courses	Contact h/week				Credits	
	L	T	P	Total								
I	MLL701 Structure and Characterization of Materials (3-0-0) 3	MLL702 Thermodynamics of materials (3-0-0) 3	MLL703 Mathematical and Computational methods in Materials (3-0-2) 4	MLL704 Materials Processing and Characterization Lab (1-1-4) 4	MLV705 (RE-1) Special topics in Materials (1-0-0) 1	5	11	1	6	18	15	
II	MLN710 (NG) Research Seminar (0-0-2) 1	MLL711 (RE) 2 Mechanical Behaviour of Materials (3-0-0) 3	PE-1 (3-0-0) 3	PE-2 (3-0-0) 3	OE-1 / PE-3 (3-0-0) 3	OE-2 / PE-4 (3-0-0) 3	6	15	0	2	17	15
Summer												
III	MLD801 (0-0-18) 9					0	0	0	0	18	9	
IV	MLD802 (0-0-18) 9					0	0	0	0	18	9	

Total = 48

Master of Technology in Polymer Science and Technology

Department of Materials Science and Engineering

The overall credits structure

Category	PC	PE	OE	Total
Credits	42	12	0	54

Program Core

PTL701	Polymer Chemistry	3	0	0	3
PTL702	Polymer Processing	3	0	0	3
PTL703	Polymer Physics	3	0	0	3
PTL704	Polymer Technology	3	0	0	3
PTL705	Polymer Characterization	3	0	0	3
PTL707	Polymer Engineering and Rheology	3	0	0	3
PTP709	Polymer Science Laboratory	0	0	4	2
PTP710	Polymer Engineering Lab	0	0	2	1
PTL713	Polymer Testing and Properties	3	0	0	3
JPD801	Major Project Part-I	0	0	12	6
JPD802	Major Project Part-II	0	0	24	12
Total Credits				42	

Program Electives

MLL717	Engineering and Specialty Polymers	3	0	0	3
MLL718	Polymeric Nanomaterials and Nanocomposites	3	0	0	3
MLL727	Smart Polymeric Materials	3	0	0	3
PTL712	Polymer Blends and Composites	3	0	0	3
PTL716	Rubber Technology	3	0	0	3
PTL718	Polymer Reaction Engineering	3	0	0	3
PTL720	Polymer Product and Mould Design	2	0	2	3
PTL722	Polymer Degradation and Stabilization	3	0	0	3
PTL724	Polymeric Coatings	3	0	0	3
PTL714	Biodegradable Polymeric Materials	3	0	0	3
JPD799	Minor Project	0	0	6	3
JPS800	Independent Study	0	3	0	3
PTV700	Special Lectures in Polymers	1	0	0	1

Sem.	Courses (Number, Abbreviated Title, L-T-P, Credits)					Lecture courses	Contact h/week				Credits
	L	T	P	Total							
I	PTL701 Polymer Chemistry (3-0-0) 3	PTL703 Polymer Physics (3-0-0) 3	PTL705 Polymer Characterization (3-0-0) 3	PTL707 Polymer Engineering and Rheology (3-0-0) 3	PTP709 Polymer Science Laboratory (0-0-4) 2	4	12	0	4	16	14
II	PTL702 Polymer Processing (3-0-0) 3	PTL704 Polymer Technology (3-0-0) 3	PTP710 Polymer Engineering Lab (0-0-2) 1	PTL713 Polymer Testing and Properties (3-0-0) 3	PE-1 (3-0-0) 3	4	12	0	2	14	13
Summer											
III	PE-2 (3-0-0) 3	OE-1 (3-0-0) 3	OE-2 (3-0-0) 3	JPD801 Major Project Part-I (0-0-12) 6		3	9	0	12	21	15
IV	JPD801 Major Project Part-II (0-0-24) 12					0	0	0	24	24	12

Total = 54

Master of Technology in Industrial Engineering

Department of Mechanical Engineering

The overall credits structure

Category	PC	PE	OE	Total
Credits	36	12	0	48

Program Core

MCD861	M.Tech. Project Part-I	0	0	24	12
MCD862	M.Tech. Project Part-II	0	0	24	12
MCL751	Industrial Engineering Systems	1	0	4	3
MCL754	Operations Planning and Control	3	0	0	3
MCL761	Probability and Statistics	3	0	0	3
MCL765	Operations Research	3	0	0	3
Total Credits				36	

Streamed Electives (MEE) in (Product Life Cycle Management)

MCL771	Value Engineering and Life Cycle Costing	3	0	0	3
MCL772	Reliability Engineering	3	0	0	3
MCL773	Quality Systems	3	0	0	3
ITL709	Maintenance Planning and Control	3	0	0	3
ITL711	Reliability, Availability and Maintainability (RAM) Engineering	3	0	0	3
ITL702	Diagnostic Maintenance and Condition Monitoring	3	0	2	4

Streamed Electives (MEE) in (Analytics and Optimization)

MCL753	Manufacturing Informatics	3	0	2	4
MCL758	Optimization	3	0	0	3
MCL770	Stochastic Modeling and Simulation	3	0	0	3
MCL865	Advanced Operations Research	3	0	0	3
COL702	Advanced Data Structures	3	0	2	4
COL770	Advanced Artificial Intelligence	3	0	2	4
COL772	Natural Language Processing or	3	0	2	4
MTL785	Natural Language Processing	3	0	0	3
COL774	Machine Learning or	3	0	2	4
ELL784	Introduction to Machine Learning	3	0	2	4
ELL791	Neural Systems and Learning Machines	3	0	0	3
MSL713	Information Systems Management	3	0	0	3
MSL717	Business Systems Analysis & Design	3	0	0	3
MTL763	Introduction to Game Theory	3	0	0	3

Streamed Electives (MEE) in (Operations Management)

MCL755	Service System Design	3	0	0	3
MCL756	Supply Chain Management	3	0	0	3
MCL757	Logistics	3	0	0	3
MCL759	Entrepreneurship	3	0	0	3
MCL760	Project Management	3	0	0	3
MCL775	Special Topics in IE	3	0	0	3
MCL866	Maintenance management	3	0	0	3
CVL746	Public Transportation Systems	3	0	0	3
CVL750	Intelligent Transportation Systems	3	0	0	3
MSL805	Services Operations Management	3	0	0	3
MSL704	Science & Technology Policy Systems	3	0	0	3
MSL877	Electronic Government	1.50	0	1.5	

Sem.	Courses (Number, Abbreviated Title, L-T-P, Credits)				Lecture courses	Contact h/week				Credits
	L	T	P	Total						
I	MCL761 Probability and Statistics (3-0-0) 3	MCL765 Operations Research (3-0-0) 3	MCL751 Industrial Engineering Systems (1-0-4) 3	PE-1 (from PLM Stream) (3-0-0) 3	4	10	0	4	14	12
II	MCL754 Operations Planning and Control (3-0-0) 3	PE-2 (3-0-0) 3	PE-3 (3-0-0) 3	PE-4 (3-0-0) 3	4	12	0	0	12	12
Professional Project Activity In Summer Vacation										
III	MCD861 Major Project Part-I (0-0-24) 12				1	3	0	24	27	15
IV	MCD862 Major Project Part-II (0-0-24) 12				0	0	0	24	24	12

Total = 48

Master of Technology in Mechanical Design

Department of Mechanical Engineering

The overall credits structure

Category	PC	PE	OE	Total
Credits	32	22	0	54

Program Core

APL701	Continuum Mechanics	3	0	0	3
MCD831	Major Project Part-I	0	0	12	6
MCD832	Major Project Part-II	0	0	24	12
MCL731	Analytical Dynamics	3	0	0	3
MCL735	CAD and Finite Element Analysis	3	0	2	4
MCL742	Design & Optimization	3	0	2	4
Total Credits				32	

MCL729	Nanomechanics	2	0	2	3
MCL737	Biomechanics of Trauma and Automotive Design	3	0	0	3
MCL738	Dynamics of Multibody Systems	2	0	2	3
MCL740	Lubrication	3	0	0	3
MCL743	Plant Equipment Design	3	0	0	3
MCL744	Design for Manufacture and Assembly	3	0	2	4
MCL746	Design for Noise Vibration and Harshness	3	0	2	4
MCL747	Design of Precision Machines	2	0	2	3
MCL749	Mechatronics Product Design	3	0	2	4
MCL777	Machine Tool Design	3	0	2	4
MCL834	Vibroacoustics	2	0	2	3
MCL837	Advanced Mechanisms	2	0	2	3
MCL838	Rotor Dynamics	3	0	2	4
MCL840	Experimental Modal Analysis and Dynamic Design	2	0	2	3
MCL845	Advanced Robotics	2	0	2	3
MCL848	Special topics in Systems Design-I	2	0	0	2
MCL849	Special topics in Systems Design-II	3	0	0	3
MCS830	Independent Study	0	3	0	3
MCV849	Special Module in Systems Design	1	0	0	1

Streamed Electives MEM - (A1) (atleast 12 credits)

MCL730	Designing with advanced materials	3	0	2	4
MCL733	Vibration and Noise	3	0	2	4
MCL736	Automotive Design	3	0	2	4
MCL741	Control Engineering	3	0	2	4
MCL745	Robotics	3	0	2	4
MCL748	Tribological Systems Design	3	0	2	4

Streamed Electives MEM - (A2) (atleast 10 credits)

MCL723	Vehicle Dynamics	2	0	2	3
MCL728	Nanotribology	3	0	0	3

Sem.	Courses (Number, Abbreviated Title, L-T-P, Credits)						Lecture courses	Contact h/week				Credits
	L	T	P	Total								
I	APL701 Continuum Mechanics (3-0-0) 3	MCL731 Analytical Dynamics (3-0-0) 3	MCL735 CAD and Finite Element Analysis (3-0-2) 4	MCL742 Design & Optimization (3-0-2) 4			4	12	0	4	16	14
II	PE-1 (3-0-2) 4	PE-2 (3-0-2) 4	PE-3 (3-0-2) 4	PE-4 (3-0-0) 3			4	12	0	6	18	15
Summer												
III	MCD831 Major Project Part-I (0-0-12) 6	PE-5 (3-0-2) 4	PE-6 (3-0-0) 3				2	6	0	14	0	13
IV	MCD832 Major Project Part-II (0-0-24) 12						0	0	0	24	24	12

Total = 54

Master of Technology in Production Engineering

Department of Mechanical Engineering

The overall credits structure

Category	PC	PE	OE	Total
Credits	31	18	0	49

Program Core

MCD881	Major Project Part-I	0	0	12	6
MCL705	Experimental Methods	3	0	2	4
MCL769	Metal Forming Analysis	3	0	2	4
MCL781	Machining Processes and Analysis	3	0	2	4
MCL782	Computational Methods	2	0	0	2
MCL784	Computer Aided Manufacturing	3	0	2	4
MCL786	Metrology	2	0	2	3
MCL787	Welding Science and Technology	3	0	2	4
Total Credits				31	

MCL751	Industrial Engineering Systems	1	0	4	3
MCL753	Manufacturing Informatics	3	0	2	4
MCL754	Operations Planning and Control	3	0	0	3
MCL773	Quality Systems	3	0	0	3
MCL776	Advances in Metal Forming	3	0	0	3
MCL777	Machine Tool Design	3	0	2	4
MCL778	Design and Metallurgy of Welded Joints	3	0	2	4
MCL780	Casting Technology	3	0	2	4
MCL783	Automation in Manufacturing	3	0	2	4
MCL785	Advanced Machining Processes	3	0	0	3
MCL788	Surface Engineering	3	0	2	4
MCL791	Processing and Mechanics of Composite Materials	3	0	2	4
MCL792	Injection Molding and Mold Design	2	0	2	3
MCL796	Additive Manufacturing	3	0	2	4
MCP790	Process Engineering	2	0	4	4

Program Electives

MCD882	Major Project Part-II	0	0	24	12
MCL729	Nanomechanics	3	0	0	3
MCL749	Mechatronics Product Design	3	0	2	4
MCL750	Product Design and Manufacturing	1	0	4	3

Sem.	Courses (Number, Abbreviated Title, L-T-P, Credits)						Lecture courses	Contact h/week				Credits
	L	T	P	Total								
I	MCL781 Machining Processes and Analysis (3-0-2) 4	MCL787 Welding Science and Technology (3-0-2) 4	MCL769 Metal Forming Analysis (3-0-2) 4				3	9	0	6	15	12
II	MCL705 Experimental Methods (3-0-2) 4	MCL784 CAM (3-0-2) 4	MCL786 Metrology (2-0-2) 3	MCL782 Computational Methods (2-0-0) 3			4	10	0	6	16	13
Professional Project Activity In Summer Vacation												
III	MCD881 Major Project Part-I (Core) (0-0-12) 6	PE-1 (3-0-0) 3	PE-2 (3-0-0) 3				2	6	0	12	18	12
IV	MCD882 Major Project Part-II (PE) (0-0-24) 12						0	0	0	24	24	12

Total = 49

Master of Technology in Thermal Engineering

Department of Mechanical Engineering

The overall credits structure

Category	PC	PE	OE	Total
Credits	36	12	3	51

Non-graded Core

MCD800 Professional Project Activity			0	0	6	3
--------------------------------------	--	--	---	---	---	---

Program Core

MCD811 Major Project Part-I (Thermal Engineering)	0	0	16	8		
MCD812 Major Project Part-II (Thermal Engineering)	0	0	24	12		
MCL701 Advanced Thermodynamics	3	0	0	3		
MCL702 Advanced Fluid Mechanics	3	0	0	3		
MCL703 Advanced Heat and Mass Transfer	3	0	0	3		
MCL704 Applied Mathematics for Thermofluids	3	0	0	3		
MCL705 Experimental Methods	3	0	2	4		
Total Credits					36	

Program Electives

MCL811 Advanced Power Generation Systems	3	0	0	3		
MCL812 Combustion	3	0	0	3		

MCL813 Computational Heat Transfer	3	0	2	4		
MCL814 Convective Heat Transfer	3	0	0	3		
MCL815 Fire Dynamics and Engineering	2	0	4	4		
MCL816 Gas Dynamics	3	0	2	4		
MCL817 Heat Exchangers	3	0	0	3		
MCL818* Heating, Ventilating and Air-conditioning	3	0	2	3		
MCL819 Lattice Boltzmann method	3	0	0	3		
MCL820 Micro/nano Scale Heat Transfer	3	0	2	4		
MCL821 Radiative Heat Transfer	3	0	0	3		
MCL822 Steam and Gas Turbines	3	0	2	4		
MCL823 Thermal Design	3	0	2	4		
MCL824 Turbocompressors	3	0	0	3		
MCL825 Design of Wind Power Farms	3	0	2	4		
MCL826 Introduction to Microfluidics	3	0	2	4		

Sem.	Courses (Number, Abbreviated Title, L-T-P, Credits)						Lecture courses	Contact h/week				Credits
	L	T	P	Total								
I	MCL701 Adv. Thermodynamics (3-0-0) 3	MCL702 Adv. Fluid Mechanics (3-0-0) 3	MCL703 Adv. Heat & Mass Transfer (3-0-0) 3	MCL704 Applied Math. (3-0-0) 3			4	12	0	0	12	12
II	MCL705 Exptl Methods (3-0-2) 4	PE-1 (3-0-0) 3	PE-2 (3-0-0) 3	PE-3 (3-0-0) 3			4	12	0	2	14	13
Summer	Professional Project Activity (compulsory audit)						0					0
III	MED811 Major Project Part-I (MET) (0-0-16) 8	PE-4 (3-0-0) 3	OE-1 (3-0-0) 3				2	6	0	12	18	14
IV	MED812 Major Project Part-II (MET) (0-0-24) 12						0	0	0	24	24	12

Total = 51

Master of Technology in Applied Optics

Department of Physics

The overall credits structure

Category	PC	PE	OE	Total
Credits	39	9	3	51

Program Core

PYD851	Major Project Part-I		0	0	12	6	PYL770	Ultra-fast Optics and Applications	3	0	0	3
PYD852	Major Project Part-II		0	0	24	12	PYL771	Green Photonics	3	0	0	3
PYL751	Optical Sources, Photometry and Metrology		3	0	0	3	PYL772	Plasmonic Sensors	3	0	0	3
PYL752	Laser Systems and Applications		3	0	0	3	PYL780	Diffractive and Micro Optics	3	0	0	3
PYL753	Optical Systems Design		3	0	0	3	PYL791	Fiber Optics	3	0	0	3
PYL755	Basic Optics and Optical Instrumentation		3	0	0	3	PYL792	Optical Electronics	3	0	0	3
PYL756	Fourier Optics and Holography		3	0	0	3	PYL795	Optics and Lasers	3	0	0	3
PYP761	Optical Fabrication and Metrology Laboratory		0	0	6	3	PYL858	Advanced Holographic Techniques	3	0	0	3
PYP762	Advanced Optics Laboratory		0	0	6	3	PYL879	Selected Topics in Applied Optics	3	0	0	3
Total Credits			39				PYL881	Selected Topics – I	1	0	0	1
							PYL882	Selected Topics – II	1	0	0	1
							PYL883	Minor Project	0	0	6	3
							PYL892	Guided Wave Photonic Sensors	3	0	0	3
							PYP763	Computational Optics Laboratory	0	0	6	3

Program Electives

PYL757	Statistical and Quantum Optics		3	0	0	3	PYP764	Advanced Optical Workshop	0	0	6	3
PYL758	Advanced Quantum Optics and Applications		3	0	0	3	PYS855	Independent Study	0	3	0	3
PYL759	Computational Optical Imaging		3	0	0	3	PYL747	Non-linear Optics	3	0	0	3
PYL760	Biomedical Optics and Bio-photonics		3	0	0	3	PYL774	Polarised Light and its Application	3	0	0	3

Sem.	Courses (Number, Abbreviated Title, L-T-P, Credits)						Lecture courses	Contact h/week				Credits
	L	T	P	Total	L	T		P	Total			
I	PYL755 Basic Optics and Optical Instrumentation (3-0-0) 3	PYL751 Optical Sources, Photometry and Metrology (3-0-0) 3	PYL753 Optical Systems Design (3-0-0) 3	PYP761 Optical Fabrication and Metrology Laboratory (0-0-6) 3	PE-1 (3-0-0) 3		4	12	0	6	18	15
II	PYL752 Laser Systems and Application (3-0-0) 3	PYL756 Fourier Optics and Holography (3-0-0) 3	PYP762 Advanced Optics Laboratory (0-0-6) 3	PE-2 (3-0-0) 3	PE-3 (3-0-0) 3		4	12	0	6	18	15
Summer												
III	OE-1 (3-0-0) 3	PYD851 Maj. Proj. Part-I (0-0-12) 6					1	3	0	12	15	9
IV	PYD852 Maj. Proj. Part-II (0-0-24) 12						0	0	0	24	24	12

Total = 51

Master of Technology in Solid State Materials

Department of Physics

The overall credits structure

Category	PC	PE	OE	Total
Credits	39	9	3	51

Program Core

PYD801	Major Project Part-I	0	0	12	6
PYD802	Major Project Part-II	0	0	24	12
PYL701	Physical Foundations of Materials Science	3	0	0	3
PYL702	Physics of Semiconductor Devices	3	0	0	3
PYL703	Electronic Properties of Materials	3	0	0	3
PYL704	Science and Technology of Thin Films	3	0	0	3
PYL705	Nanostructured Materials	3	0	0	3
PYP701	Solid State Materials Laboratory I	0	0	6	3
PYP702	Solid State Materials Laboratory II	0	0	6	3
Total Credits				39	

Program Electives

PYL707	Characterization Techniques for Materials	3	0	0	3
PYL723	Vacuum Science and Cryogenics	3	0	0	3
PYL724	Advances in Spintronics	3	0	0	3
PYL725	Surface Physics and Analysis	3	0	0	3
PYL726	Semiconductor Device Technology	3	0	0	3
PYL727	Energy Materials and Devices	3	0	0	3
PYL728	Quantum Heterostructures	2	0	0	2
PYL729	Nanoprobe Techniques	1	0	0	1
PYV759	Selected Topics in Solid State Materials	1	0	0	1

Sem.	Courses (Number, Abbreviated Title, L-T-P, Credits)						Lecture courses	Contact h/week				Credits
	L	T	P	Total								
I	PYL701 Physical Foundations of Materials Science (3-0-0) 3	PYL702 Physics of Semiconductor Devices (3-0-0) 3	PYL703 Electronic Properties of Materials (3-0-0) 3	PYP701 Solid State Materials Laboratory-I (0-0-6) 3	PE-1 (3-0-0) 3		4	12	0	6	18	15
II	PYL704 Science and Technology of Thin Films (3-0-0) 3	PYL705 Nanostructured Materials (3-0-0) 3	PYP702 Solid State Materials Laboratory-II (0-0-6) 3	PE-2 (3-0-0) 3	PE-3 (3-0-0) 3		4	12	0	6	18	15
Summer												
III	OE-1 (3-0-0) 3	PYD801 Maj. Proj. Part-I (0-0-12) 6					1	3	0	12	15	9
IV	PYD802 Maj. Proj. Part-II + Report (0-0-24) 12						0	0	0	24	24	12

Total = 51

Master of Technology in Textile Engineering

Department of Textile and Fibre Engineering

The overall credits structure

Category	PC	PE	OE	Total
Credits	42	12	0	54

Program Core

TXD801	Major Project Part-I (TXE)	0	0	12	6	TXL740	Science & App. of Nanotechnology in Textiles	3	0	0	3
TXD803	Major Project Part-II (TXE)	0	0	24	12	TXL750	Science of Clothing Comfort	3	0	0	3
TXL721	Theory of Yarn Structure	3	0	0	3	TXL751	Apparel Engineering and Quality Control	2	0	2	3
TXL722	Mechanics of Spinning Processes	3	0	0	3	TXL752	Design of Functional Clothing	3	0	0	3
TXL725	Mechanics of Spinning Machines	3	0	0	3	TXL766	Design and Manuf. of Textile Structural Composites	3	0	0	3
TXL731	Theory of Fabric Structure	3	0	0	3	TXL771	Electronics and Controls for Textile Industry	3	0	2	4
TXL732	Advanced Fabric Manufacturing Systems	3	0	0	3	TXL772	Computational Methods for Textiles	2	0	2	3
TXL775	Technical Textiles	3	0	0	3	TXL773	Medical Textiles	3	0	0	3
TXL783	Design of Experiments and Statistical Techniques	3	0	0	3	TXL774	Process Control in Yarn & Fabric Manufacturing	3	0	0	3
TXP725	Mechanics of Textile Machines Laboratory	0	0	2	1	TXL777	Product Design and Development	3	0	0	3
TXP761	Evaluation of Textile Materials	0	0	4	2	TXL781	Project Appraisal and Finance	3	0	0	3
Total Credits				42		TXL782	Production and Operations Management in Textile Industry	3	0	0	3

Program Electives

TXD809	Mini Project (Textile Engineering)	0	0	8	4	TXL784	Supply Chain Management in Textile Industry	3	0	0	3
TXL700	Modelling and Simulation in Fibrous Assemblies	2	0	2	3	TXL786	Technology of Textile Coating and Lamination	2	0	2	3
TXL710	High Performance and Specialty Fiber	3	0	0	3	TXL807	Seminar (Textile Engineering)	0	2	0	2
TXL712	Polymer and Fibre Physics	3	0	0	3	TXS805	Independent Study (Textile Engineering)	0	3	0	3
TXL719	Functional & Smart Textiles	3	0	0	3	TXV702	Management of Textile Business	1	0	0	1
TXL724	Textured Yarn Technology	3	0	0	3	TXV703	Special Module in Textile Technology	1	0	0	1
TXL734	Nonwoven Processes and Products	3	0	0	3	TXV704	Special Module in Yarn Manufacture	1	0	0	1
						TXV705	Special Module in Fabric Manufacture	1	0	0	1

Sem.	Courses (Number, Abbreviated Title, L-T-P, Credits)						Lecture courses	Contact h/week				Credits
	L	T	P	Total	L	T		P	Total			
I	TXL721 Theory of Yarn Structure (3-0-0) 3	TXL722 Mechanics of Spinning Processes (3-0-0) 3	TXL731 Theory of Fabric Structure (3-0-0) 3	TXL732 Advanced Fabric Manufacturing Systems (3-0-0) 3		PE-1 (3-0-0) 3	5	15	0	0	15	15
II	TXL775 Technical Textiles (3-0-0) 3	TXL725 Mechanics of Spinning Machines (3-0-0) 3	TXL783 Design of Expt. and Stat. Tech. (3-0-0) 3	TXP761 Evaluation of Textile Materials (0-0-4) 2	TXP725 Mechanics of Spinning Machines Lab. (0-0-2) 1	PE-2 (3-0-0) 3	4	12	0	6	18	15
Summer												
III	TXD801 Major Project Part-I (TXE) (0-0-12) 6	PE-3 (3-0-0) 3	PE-4 (3-0-0) 3				2	6	0	12	18	12
IV	TXD803 Major Project Part-II (TXE) (0-0-24) 12						0	0	0	24	24	12

Total = 54

Master of Technology in Textile Chemical Processing

Department of Textile and Fibre Engineering

The overall credits structure

Category	PC	PE	OE	Total
Credits	42	12	0	54

Program Core

TXD805	Major project part-I (TXC)			0	0	12	6	TXL719	Functional and Smart Textiles	3	0	0	3
TXD806	Major project part-II (TXC)			0	0	24	12	TXL724	Textured Yarn Technology	3	0	0	3
TXL712	Polymer and Fibre Physics			3	0	0	3	TXL740	Science and Application of Nanotechnology in Textiles	3	0	0	3
TXL747	Colour Science			3	0	0	3	TXL750	Science of Clothing Comfort	3	0	0	3
TXL748	Advances in Finishing of Textiles			3	0	0	3	TXL751	Apparel Engineering and Quality Control	2	0	2	3
TXL749	Theory and Practice of Dyeing			3	0	0	3	TXL752	Design of Functional Clothing	3	0	0	3
TXL753	Advanced Textile Printing Technology			2	0	0	2	TXL755	Textile Wet Processing Machines: Automation and Control*	3	0	0	3
TXL754	Sustainable Chemical Processing of Textiles			2	0	0	2	TXL756	Textile Auxiliaries*	3	0	0	3
TXL783	Design of Experiments and Statistical Techniques			3	0	0	3	TXL766	Design and Manuf. of Textile Structural Composites	3	0	0	3
TXP748	Textile Preparation and Finishing Lab			0	0	2	1	TXL773	Medical Textiles	3	0	0	3
TXP749	Textile Coloration Lab			0	0	2	1	TXL775	Technical Textiles	3	0	0	3
TXP751	Characterization and Evaluation of dyed and finished textiles Lab			0	0	2	1	TXL777	Product Design and Development	3	0	0	3
TXS751	Research Seminar			0	0	2	1	TXL781	Project Appraisal and Finance	2	1	0	3
TXR752	Professional Practices			0	0	2	1	TXL782	Production and Operations Management in Textile Industry	3	0	0	3
TXT800	Industrial Summer Training			Non credit				TXL784	Supply Chain Mgmt. in Textile Industry	3	0	0	3
Total Credits				42				TXL786	Technology of Textile Coating and Lamination	2	0	2	3

Program Electives

MSL760	Marketing Management			2	0	2	3	TXP711	Polymer and Fibre Chemistry Laboratory	0	2	0	1
MSL802	Management of Intellectual Property Rights			3	0	0	3	TXP712	Polymer and Fibre Physics Laboratory	0	0	2	1
MSL816	Total Quality Management			2	0	2	3	TXP716	Fibre Production and Post Spinning Operation Laboratory	0	0	4	2
TXD812	Mini Projects (TCP)			0	0	6	3	TXP761	Evaluation of Textile Materials	0	0	4	2
TXL711	Polymer and Fibre Chemistry			3	0	0	3	TXS811	Independent Study	0	3	0	3
TXL713	Technology of Melt Spun Fibres			3	1	0	4	TXV707	Special Module-Textile Chemical Processing-1	1	0	0	1
TXL714	Advanced Materials Characterization Techniques			1	0	0	1	* TCP PE Basket					
TXL715	Technology of Solution Spun Fibres			3	0	0	3						

Sem.	Courses (Number, Abbreviated Title, L-T-P, credits)							Lecture courses	Contact h/week				Credits
	L	T	P	Total									
I	TXL712 Polymer & Fibre Physics (3-0-0) 3	TXL747 Colour Science (3-0-0) 3	TXL749 Theory and Practice of Dyeing (3-0-0) 3	TXL753 Advanced Textile Printing Technology (2-0-0) 2	TXP749 Textile Coloration Lab (0-0-2) 1	TXP751 Characterization of Chemicals and Finished Textiles Lab (0-0-2) 1	TXR752 Professional Practices (0-0-2) 1	4	11	0	6	17	14
II	TXL748 Advances in Finishing of Textiles (3-0-0) 3	TXL754 Sustainable Chemical Processing of Textiles (2-0-0) 2	TXL783 Design of Experiments and Statistical Techniques (3-0-0) 3	TXP748 Textile Preparation and Finishing Lab (0-0-2) 1		PE-1 (3-0-0) 3	PE-2 (3-0-3) 3	5	14	0	2	16	15
Summer	TXT800 Industrial Summer Training												
III	TXD805 Major Project Part-I (TCP) (0-0-12) 6			TXS751 Research Seminar (0-0-2) 1	PE-3* (3-0-0) 3	PE-4 (3-0-0) 3		2	6	0	14	18	13
IV	TXD806 Major Project Part-II (TCP) (0-0-24) 12							0	0	0	24	24	12

* From TCP PE Basket

Total = 54

Master of Technology in Fibre Science and Technology

Department of Textile and Fibre Engineering

The overall credits structure

Category	PC	PE	OE	Total
Credits	42	12	0	54

Program Core

TXD802	Major Project Part-I	0	0	12	6	TXL734	Nonwoven Processes and Products	3	0	0	3
TXD804	Major Project Part-II	0	0	24	12	TXL740	Science & App. of Nanotechnology in Textiles	3	0	0	3
TXL711	Polymer and Fibre Chemistry	3	0	0	3	TXL741	Env. Manag. in Textile and Allied Industries	3	0	0	3
TXL712	Polymer and Fibre Physics	3	0	0	3	TXL747	Colour Science	3	0	0	3
TXL713	Technology of Melt Spun Fibres	3	1	0	4	TXL750	Science of Clothing Comfort	3	0	0	3
TXL714	Advanced Materials Characterization Techniques	1	0	0	1	TXL752	Design of Functional Clothing	3	0	0	3
TXL715	Technology of Solution Spun Fibres	3	0	0	3	TXL754	Sustainable Chemical Processing of Textiles	2	0	0	2
TXL748	Advances in Finishing of Textiles	3	0	0	3	TXL772	Computational Methods for Textiles	2	0	2	3
TXL749	Theory and Practice of Dyeing	3	0	0	3	TXL773	Medical Textiles	3	0	0	3
TXP711	Polymer and Fibre Chemistry Laboratory	0	0	2	1	TXL775	Technical Textiles	3	0	0	3
TXP712	Polymer and Fibre Physics Laboratory	0	0	2	1	TXL777	Product Design and Development	3	0	0	3
TXP716	Fibre Production and Post Spinning Operation Laboratory	0	0	4	2	TXL781	Project Appraisal and Finance	3	0	0	3
	Total Credits				42	TXL782	Production and Operations Management in Textile Industry	3	0	0	3
						TXL783	Design of Experiments and Statistical Techniques	3	0	0	3
						TXL784	Supply Chain Management in Textile Industry	3	0	0	3
						TXL786	Technology of Textile Coating and Lamination	2	0	2	3
						TXS806	Independent Study (TTF)	0	3	0	3
						TXV701	Process Cont. and Econ. in Manmade Fibre Prod.	1	0	0	1
						TXV702	Management of Textile Business	1	0	0	1
						TXV706	Special Module in Fibre Science	1	0	0	1
						TXV707	Special Module in Textile Chemical Processing	1	0	0	1

Program Electives

TXL700	Modelling and Simulation in Fibrous Assemblies	2	0	2	3						
TXL710	High Performance and Speciality Fiber	3	0	0	3						
TXL719	Functional & Smart Textiles	3	0	0	3						
TXL724	Textured Yarn Technology	3	0	0	3						

Sem.	Courses (Number, Abbreviated Title, L-T-P, Credits)							Lecture courses	Contact h/week				Credits
	L	T	P	Total	L	T	P		Total				
I	TXL711 Polymer & Chemistry (3-0-0) 3	TXP711 Polymer & Fibre Chemistry Lab (0-0-2) 1	TXL712 Polymer & Fibre Physics (3-0-0) 3	TXP712 Polymer & Fibre Physics Lab (0-0-2) 1	TXL713 Technology of Melt Spun Fibres (3-1-0) 4	TXL749 Theory and Practice of Dyeing (3-0-0) 3		4	12	1	4	17	15
II	TXL715 Technology of Soln Spun Fibres (3-0-0) 3	TXP716 Fibre Production & Post Spinning Operation Lab (0-0-4) 2	TXL748 Advances in Finishing of Textiles (3-0-0) 3	TXL714 Characterization of advanced materials (1-0-0) 1		PE-2 (3-0-0) 3	PE-1 (3-0-0) 3	5	12	0	6	18	15
Summer													
III	TXD802 Maj. Proj. Part-I (TTF) (0-0-12) 6				PE-3 (3-0-0) 3	PE-4 (3-0-0) 3		2	6	0	12	18	12
IV	TXD804 Maj. Proj. Part-II (TTF) (0-0-24) 12							0	0	0	24	24	12

Total = 54

Master of Technology in Radio Frequency Design and Technology

Centre for Applied Research and Electronics

The overall credits structure

Category	Core		Elective		Total
	PC	BC	PE	OE	Total
	Credits	24	3	24*/21**	0*/3**

* For students with M.Tech Dissertation

** For students without M.Tech Dissertation

Program Core

CRD802	Minor Project	0	0	6	3
CRD811	Major Project-I	0	0	12	6
CRL702	Architectures and Algorithms for DSP Systems	2	0	4	4
CRL711	CAD of RF and Microwave Circuits	3	0	2	4
CRL724	RF and Microwave Measurements	3	0	0	3
CRP718	RF and Microwave Measurement Lab	1	0	6	4
Total Credits				24	

Bridge Course (Core)

CRL601	Basics of Statistical Signal Analysis	2	0	2	3
CRL611	Basics of RF and Microwaves	2	1	0	3
CRL621	Fundamentals of Semiconductor Devices	3	0	0	3

Program Electives

ELL711	Signal Theory	3	0	0	3
ELL712	Digital Communications	3	0	0	3
ELL714	Basic Information Theory	3	0	0	3
ELL718	Statistical Signal Processing	3	0	0	3
ELL719	Detection and Estimation Theory	3	0	0	3
ELL720	Advanced Digital Signal Processing	3	0	0	3
ELL725	Wireless Communications	3	0	0	3
ELL731	Mixed Signal Circuit Design	3	0	0	3
ELL734	MOS VLSI design	3	0	0	3
ELL735	Analog Integrated Circuits	3	0	0	3
ELL784	Introduction to Machine Learning	3	0	0	3
ELL815	MIMO Wireless Communications	3	0	0	3
ELL833	CMOS RF IC Design	3	0	0	3

ELP725	Wireless Communication Laboratory	0	1	4	3
CRD802	Minor Project	0	0	6	3
CRD812	Major Project-II	0	0	24	12
CRD814	Major Project-III	0	0	12	6
CRL704	Sensor Array Signal Processing	3	0	0	3
CRL706	Selected Topics in Radars and Sonars	3	0	0	3
CRL707	Human & Machine Speech Communication	3	0	0	3
CRL708	Sonar Systems Engineering	3	0	0	3
CRL709	Underwater Electronic Systems	3	0	0	3
CRL712	RF and Microwave Active Circuits	3	0	0	3
CRL715	Radiating Systems for RF Communication	3	0	0	3
CRL722	RF and Microwave Solid State Devices	3	0	0	3
CRL725	Technology of RF and Microwave Solid State Devices	3	0	0	3
CRL726	RF MEMS Design and Technology	3	0	0	3
CRL727	Introduction to Quantum Electron Devices	3	0	0	3
CRL729	Sensors and Transducers	3	0	0	3
CRL731	Selected Topics in RFDT-I	3	0	0	3
CRL732	Selected Topics in RFDT-II	3	0	0	3
CRL733	Selected Topics in RFDT-III	3	0	0	3
CRL734	Selected Topics in RFDT-IV	3	0	0	3
CRP723	Fabrication Techniques for RF and Microwave Devices	1	0	4	3
CRS735	Independent Study	0	3	0	3
CRV741	Acoustic Classification using Passive Sonar	1	0	0	1
CRV742	Special Module in Radio Frequency Design and Technology-I	1	0	0	1
CRV743	Special Module in Radio Frequency Design and Technology-II	1	0	0	1

Sem.	Courses (number, Abbreviated Title, L-T-P, Credits)				Lecture courses	Contact h/week				Credits
	L	T	P	Total						
I	CRL711 CAD of RF and Microwave Circuits (3-0-2) 4	CRL718 RF and Microwave Measurement Lab (1-0-6) 4	PE-1 (3-0-0) 3	Bridge course : Any one of the following three : CRL601 Basics of Stat. Signal Analysis (2-0-2) 3/ CRL611 Basics of RF and Microwaves (2-1-0) 3/ CRL621 Fund. of Semiconductor Devices (3-0-0) 3	4	9-10	10	8-10	18-19	4
II	CRL724 RF and Microwave Measurements (3-0-0)	CRL702 Architectures and Algorithms for DSP Systems (2-0-4) 4	PE-2 (3-0-0) 3	CRD802 Minor Project (0-0-6) 3	3	8	0	10	18	13
Summer										
III	CRD811 Major Project-I (0-0-12)		PE-3 (3-0-0) 3	PE-4 (3-0-0) 3	2	6	0	12	18	12
IV Project Option OR			CRD812 (0-0-24)*		0	0	0	24	24	12
IV Course Option	PE-5 (3-0-0) 3		CRD814 Major Project-III (0-0-12) 6	OE-1 (3-0-0) 3	2	6	0	12	18	12

* **Note** : Minimum eligibility criterion for doing CRD812 (M.Tech. Project 2) in final semester leading to M.Tech. with Dissertation shall be B grade in CRD811. However, additional/higher criteria may be set CFB based on which CRC shall approve/disapprove this option for each student.

Total = 51

Master of Technology in Atmospheric-Oceanic Science and Technology
Centre for Atmospheric Sciences

The overall credits structure

Category	PC	PE	OE	Total
Credits	33	21	0	54

Program Core

	ASL758 General Circulation of the Atmosphere	3	0	0	3
ASD881 Project-I	ASL759 Land-Atmosphere Interactions	3	0	0	3
ASL730 Introduction to Weather, Climate and Air Pollution	ASL760 Renewable Energy Meteorology	3	0	0	3
ASL732 Mathematical and Computational Methods for Atmospheric and Oceanic Sciences	ASL761 Earth System Modeling	3	0	0	3
ASL733 Physics of the Atmosphere	ASL762 Air-Sea Interaction	3	0	0	3
ASL734 Dynamics of the Atmosphere	ASL763 Coastal Ocean and Estuarine Processes	3	0	0	3
ASL735 Atmospheric Chemistry and Air Pollution	ASL821 Advanced Dynamic Meteorology	3	0	0	3
ASL736 Science of Climate Change	ASL822 Climate Variability	3	0	0	3
ASL737 Physical and Dynamical Oceanography	ASL823 Geophysical Fluid Dynamics	3	0	0	3
ASL738 Numerical Modeling of the Atmosphere and Ocean	ASL824 Parameterization of Physical Processes	3	0	0	3
ASP731 Data Analysis Methods for Atmospheric and Oceanic Sciences	ASL826 Ocean Modeling	2	0	2	3
ASP820 Advanced Data Analysis for Weather and Climate	ASL827 Advanced Dynamic Oceanography	3	0	0	3
Total Credits		33			
	ASL851 Special Topics in Climate	3	0	0	3
	ASL852 Special Topics in Oceans	3	0	0	3
	ASL853 Special Topics in Atmosphere	3	0	0	3
	ASL854 Special Topics in Air Pollution Studies	3	0	0	3
	ASL856 Special Topics in Atmospheric and Oceanic Observations	2	0	2	3
	ASP825 Mesoscale Modeling	0	0	6	3
	ASP855 Special Topics in Atmosphere and Ocean	1	0	4	3
	ASP867 Special Module in Weather Forecasting	0	0	2	1
	ASP868 Special Module in Atmospheric and Oceanic Observations	0	0	2	1
	ASS800 Independent Study	0	3	0	3
	ASV862 Special Module in Climate	1	0	0	1
	ASV863 Special Module in Oceans	1	0	0	1
	ASV864 Special Module in Atmosphere	1	0	0	1
	ASV865 Special Module in Air Pollution Studies	1	0	0	1
	ASV866 Special Module in Atmosphere and Ocean	1	0	0	1

Program Electives

ASC869 Atmospheric and Oceanic Science Colloquium	0	1	0	1	
ASD882 Project-II	0	0	24	12	
ASL750 Boundary Layer Meteorology	3	0	0	3	
ASL751 Dispersion of Air Pollutants	3	0	0	3	
ASL752 Mesoscale Meteorology	3	0	0	3	
ASL753 Atmospheric Aerosols	3	0	0	3	
ASL754 Cloud Physics	3	0	0	3	
ASL755 Remote Sensing of the Atmosphere and Ocean	3	0	0	3	
ASL756 Synoptic Meteorology	3	0	0	3	
ASL757 Tropical Weather and Climate	3	0	0	3	

Sem.	Courses (Number, Abbreviated Title, L-T-P, Credits)						Lecture courses	Contact h/week				Credits
	L	T	P	Total	L	T		P	Total			
I	ASL730 Introduction to Weather, Climate and Air Pollution (1-0-0) 1	ASP731 Data Analysis Methods for Atmospheric and Oceanic Sciences (0-0-4) 2	ASL732 Mathematical and Computational Methods for Atmospheric and Oceanic Sciences (2-0-2) 3	ASL733 Physics of the Atmosphere (3-0-0) 3	ASL734 Dynamics of the Atmosphere (3-0-0) 3	ASL735 Atmospheric Chemistry and Air Pollution (3-0-0) 3	5	12	0	6	18	15
II	ASL736 Science of Cli- mate Change (3-0-0) 3	ASL737 Physical and Dynamical Oceanography (3-0-0) 3	ASL738 Numerical Modeling of the Atmosphere and Ocean (2-0-2) 3	ASP820 Advanced Data Analysis for Weather and Climate (1-0-4) 3	PE-1 (3-0-0) 3		5	12	0	6	18	15
Summer												
III	ASD881 Project-I (Core) (0-0-12) 6	PE-2 (3-0-0) 3	PE-3 (3-0-0) 3				2	6	0	12	18	12
IV Project Option OR	ASD882 Project-II (0-0-24) 12						0	0	0	24	24	12
IV Course Option	PE-4 (3-0-0) 3	PE-5 (3-0-0) 3	PE-6 (3-0-0) 3	PE-7 (3-0-0) 3			4	12	0	0	12	12

Total = 54

Master of Technology in Electric Mobility

Centre for Automotive Research and Tribology

The overall credits structure

Category	PC	PE	OE	Total
Credits	24	18	6	48

Program Core

CTL703	Introduction to Electric Vehicles	3	0	0	3
CTL705	Engineering of Electric Vehicles	3	0	0	3
CTL707	Batteries for Electric Vehicles: Multidisciplinary Perspectives	3	0	0	3
CTL717	Power Electronics and Drives for Electric Vehicles	3	0	0	3
CTP702	Electric Vehicle Laboratory	1	0	4	3
CTP704	Electric Vehicle Laboratory	1	0	4	3
CTD 801	M.Tech. Major Project Part-I	0	0	12	6
Total Credits		24			

Program Electives

CTL719	Energy Storage Systems for EVs	3	0	0	3
CTL711	Embedded Systems for Automotive Sector	3	0	0	3
CTL709	Charging Infrastructure for EVs	3	0	0	3
CTL725	Recycling, Reusability and Remanufacturing	3	0	0	3
CTL727	Materials for Electric Vehicle Applications	3	0	0	3
CTL729	Automotive Reliability and Life Testing	3	0	0	3
CTL731	Automotive Noise and Condition Monitoring	3	0	0	3
CTL717	Electric Energy Storage Systems	3	0	0	3
CTL735	Computer Aided Analysis of Power Electronics	3	0	0	3
CTL713	Connected and Autonomous Vehicles	3	0	0	3
CTD802	M.Tech. Major Project Part-II	0	0	24	12
	Minor Project	0	0	6	3

Sem.	Courses (Number, Abbreviated Title, L-T-P, Credits)				Lecture courses	Contact h/week				Credits
	L	T	P	Total						
I	CTL703 Introduction to Electric Vehicles (3-0-0) 3	CTL705 Engineering of Electric Vehicles (3-0-0) 3	CTP702 Electric Vehicle Laboratory 1 (1-0-4) 3	PE-1 (3-0-0) 3	3	10	0	4	14	12
II	CTL707 Batteries for Electric Vehicles: Multidisciplinary Perspectives (3-0-0) 3	CTL717 Power Electronics and Drives for Electric Vehicles (3-0-0) 3	CTP704 Electric Vehicle Laboratory 2 (1-0-4) 3	PE-2 (3-0-0) 3	3	10	0	4	14	12
III	CTD801 Major Project Part I (0-0-12) 6	OE-1 (3-0-0) 3	OE-2 (3-0-0) 3		2	6	0	12	18	12
M.Tech. Option I (With Major project Part – II with a Thesis Submission*)										
IV	CTD802 Major project Part II (0-0-24) 12				0	0	0	24	24	12
OR										
IV	PE-3 (3-0-0) 3	PE-4 (3-0-0) 3	PE-5 (3-0-0) 3	PE-6 (3-0-0) 3	4	12	0	0	12	12

* **Note** : Major Project Part - II option has a requirement of Min. CGPA 8 at the end 3rd Sem and B Grade in Major Project Part - I. In exceptional cases CRC may waive the CGPA requirement

Total = 48

Master of Technology in Biomedical Engineering

Centre for Biomedical Engineering

The overall credits structure

	Core			Elective		Total
Category	BC	CC	CP	PE	OE	Total
Credits	02	18	21	09	03	53

Bridge Courses (Core)

BMV701	Basic Electronics	1	0	0	1
BMV702	Basic Mathematics for Biologists	1	0	0	1
BMV703	Basic Biology & Physiology	1	0	0	1
BMV705	Mechanics of Biomaterials	1	0	0	1

Total Credits 2'

¹ Students shall take any two core bridge courses based on their background (Engg./ Biology) on suggestion of the program adviser.

Program Core

BML738	Biomedical Data Analysis	3	0	0	3
BML770	Fundamentals of Biomechanics	3	0	0	3
BML710	Industrial Biomaterial Technology	3	0	0	3
BML720	Medical Imaging	3	0	0	3
BML737	Application of Mathematics in Biomedical Engineering	2	0	0	2
BML760	Biomedical Ethics, Safety and Regulatory Affairs	2	0	0	2
BML740	Biomedical Instrumentation	3	0	0	3
BMP743	Basic Biomedical Laboratory	0	0	4	2

BMD801	Major Project-1	0	0	0	9
BMD802	Major Project-2	0	0	0	12
Total Credits					39

Program Electives

BML713	Pharmaceuticals, Efficacy and Delivery	3	0	0	3
BML790	Modern Medicine: An Engg. Perspective	2	1	0	3
BML810	Tissue Engineering	3	0	0	3
BML741	Medical Device Design	2	0	4	4
BML815	Selected Topics in Biomedical Engineering	2	0	0	2
BML860	Nanomedicine	3	0	0	3
BML820	Biomaterials	3	0	0	3
BML735	Biomedical Image and Signal Processing	2	0	2	3
BML850	Cancer: Diagnosis and Therapy	3	0	0	3
BML830	Biosensor Technology	3	0	2	4
BML750	Point of Care Medical Diagnostic Devices	3	0	0	3
BML771	Orthopaedic Device Design	2	0	0	2
BML772	Biofabrication	2	0	2	3
BML781	Orthopedic Device Design and Prototyping	2	0	2	3
BML800	Research Techniques in Biomedical Engg.	3	0	0	3
BMV704	Fundamentals of Neuromechanics	1	0	0	1

Sem.	Courses (Number, Abbreviated Title, L-T-P, credits)						Lecture courses	Contact h/week				Credits
	L	T	P	Total								
I	BML770 Fundamentals of Biomechanics (3-0-0) 3	BML710 Industrial Biomaterial Technology (3-0-0) 3	BML720 Medical Imaging (3-0-0) 3	PE-1# (2-4)	BC-1 (1)	BC-2 (1)	6	13-15	0	0	13-15	13-15 ¹
II	BML737 Application of Mathematics in Biomedical Engineering (2-0-0) 2	BML760 Ethics, Safety and Regulatory Affairs (2-0-0) 2	BML740 Biomedical Instrumentation (3-0-0) 3	BMP743 Basic Biomedical Laboratory (0-0-4) 2	PE-2# (2-4)	PE-3# (2-4)	5	11-13	0	4	15-17	13-15 ¹
Summer												
III	BMD801 Major Project 1 (0-0-18) 9			OE-1 (2-4)			2	2-4	0	18	20-22	11-13
IV	BMD802 Major Project 2 (0-0-24) 12						0	0	0	24	24	12

PE-1, 2 & 3; OE-1: Minimum 2 to maximum 4 credits can be taken by students towards each program or open elective courses.

Total credits for three program electives and one open electives should be a minimum of 12.

! Total course credits for students in each semester should not exceed 15 for the first two semesters.

Total = 53

Master of Technology in Cyber Security

Interdisciplinary Programme

The overall credits structure

Category	PC	PE	OE	Total
Credits	32	16-24	00	48-56

Program Core

JCD891	Minor Project		0	0	6	3
JCD892	M.Tech. Project Part-I		0	0	12	6
JCD893	M.Tech Project Part-II		0	0	24	12
COL702	Advanced Data Structures/ ELL781 Software Fundamentals for Computer Tech**	3	0	2	4*	
COL759	Cryptography & Computer Security/ MTL730 Cryptography		3	0	0	3
SIL765	Network and System Security/ ELL810 Cyber Security and Information Assurance	3	0	2	4*	

** Note the CSE background students will do COL702 and non-CS background students will do ELL781 or as instructed by PEC.

* Note that since ELL781 & ELL810 being 3-0-0 courses the lab component will be made up with registering for JCP781(0-0-2)1 & JCP810 (0-0-2)1 respectively.

Total Credits 32

Bridge Courses

Min. 6 credits, may be waived in exceptional cases on recommendation by PEC

SIL618	Computer Architecture	3	0	2	4
COL633	Resources Mgmt. in Computer Systems	3	0	2	4
COL671	Artificial Intelligence	3	0	2	4
COL672	Computer Networks	3	0	2	4

Streamed Program Electives (PE)

*Program Electives can be added on the recommendation by PEC

*Note - Students are required to do three electives in their respective streams and one each in the other two streams to ensure breadth.

Streamed Electives(JCS) in System Security and Cyber Forensics

JCS816	Independent Study	0	3	0	3
COL718	Architecture of high performance Computers	3	0	2	4
COL724	Advanced Computer Networks	3	0	2	4
COL728	Compiler Design	3	0	3	4.5
COL729	Compiler Optimisation	3	0	3	4.5
COL732	Virtualization and Cloud Computing	3	0	2	4
COL733	Cloud Computing Technology Fundamental	3	0	2	4
COL768	Wireless Networks	3	0	2	4
COL851	Special Topics in Operating Systems	3	0	0	3
COL861	Special Topics in Hardware Systems	3	0	0	3
COL864	Special Topics in Artificial Intelligence	3	0	0	3
COL865	Special Topics in Computer Applications	3	0	0	3
COL867	Special Topics in High Speed Networks	3	0	0	3
COL870	Special Topics in Machine Learning	3	0	0	3
COL871	Special Topics in Programming Language	3	0	0	3
COL874	Special Topics in Compiler and Lang Impl	3	0	0	3
COL876	Special Topics in Formal Methods	3	0	0	3
COV881	Special Module in Hardware Systems	1	0	0	1

Sem.	Courses (Number, Abbreviated Title, L-T-P, Credits)					Lecture courses	Contact h/week				Credits
	L	T	P	Total							
I	COL702/ ELL781+JCP781 Advanced Data Structures/Software Fundamentals for Computer Tech (3-0-2) 4/(3-0-0)3+ (0-0-2)1	Bridge-1 (3-0-2)4	COL759/MTL730 Cryptography & Computer Security / Cryptography (3-0-0) 3	PE-1 (3-4)		3-4	9-12	0	2-6	11-18	10-15
II	JCD891 Minor Project (0-0-6) 3	Bridge-1 (3-0-2)4	SIL765/ELL810 +JCP810 Cyber Security and In-formation Assurance/ Network and System Security (3-0-2) 4/(3-0-0)3+ (0-0-2)1	PE-2 (3-4)		2-3	6-9	0	8-12	14-21	10-15
III	JCD892 MTP-I (0-0-12) 6	PE-3 (3-4)	PE-4 (3-4)			2	6	0	12-16	18-24	12-15
IV	JCD893 MTP-II (0-0-24) 12	PE-5 (3)				1	3	0	20-22	23-25	15

NOTE: 1. Registration for MTP-II has a requirement of Min. CGPA 7.5 at the end 3rd sem and B Grade in JCD892. In exceptional cases PEC may waive the CGPA requirement

2. MTP – II can also be done in a collaborative manner with Industry/University.

In future joint degree programmes with other institutes/universities can be considered.

We are proposing M. Tech in Cyber security with 20 seats with additional Full-time/Part-time sponsored candidates from Industry/Government. The admissions will be done through GATE in CS/EC/MA/EE as per Institute norms for other interdisciplinary programs.

Total = 48-56

COV882	Special Module in Software Systems	1	0	0	1	MTL735	Advanced Number Theory	3	0	0	3
COV887	Special Module in High Speed Networks	1	0	0	1	MTL744	Mathematical Theory of Coding	3	0	0	3
COL886	Special Topics in Operating Systems	3	0	0	3	MTL782	Data Mining	3	0	2	4
ELV710	Special Module in Cyber Security	1	0	0	1	MTL811	Mathematical Foundation of AI	3	0	0	3
ELL714	Basic Information Theory	3	0	0	3	SIL771	Special Topics in Cyber Security	3	0	0	3
ELL785	Computer Communication Networks	3	0	0	3	SIL773	Digital Watermarking and Steganography	3	0	0	3
ELL800	Numerical Linear Algebra and Optimization in Engineering	3	0	0	3	SIL775	Biometric Security	3	0	0	3
ELL880	Special Topics in Computers-I	3	0	0	3	SIL779	Data Privacy	3	0	0	3
ELL881	Special Topics in Computers-II	3	0	0	3	SIV810	Special Module in Cyber Security	1	0	1	1.5
ELL892	Internet Technologies	3	0	0	3	SIV812	Special Module in Computer Forensics	1	0	1	1.5
ELL893	Cyber-Physical Systems	3	0	0	3	SIV814	Special Module in Application Security	1	0	1	1.5
ELL895	Network Security	3	0	0	3	SIL763	Introduction to Blockchains, Cryptocurrencies and Smart contracts	3	0	2	4
ELL897	Network Management	3	0	0	3						
MSL852	Network System: Applications and Mgmt.	3	0	0	3	Streamed Electives(JCS) in Embedded System and Hardware Security					
MSL855	Electronic Commerce	3	0	0	3	JCS816	Independent Study	0	3	0	3
MSL878	Electronic Payments	1.5	0	0	1.5	COL718	Architecture of High-Performance Computer	3	0	2	4
MSL893	Public Policy in the Information Age	1.5	0	0	1.5	COL719	Synthesis of Digital Systems	3	0	2	4
MTL744	Mathematical Theory of Coding	3	0	0	3	COL720	Real Time Systems	3	0	2	4
SIL771	Special Topics in Cyber Security	3	0	0	3	COL750	Foundations of Automatic Verification	3	0	2	4
SIL773	Digital Watermarking and Steganography	3	0	0	3	COL788	Advanced Topics in Embedded Computing	3	0	0	3
SIL775	Biometric Security	3	0	0	3	COL861	Special Topics in Hardware Systems	3	0	0	3
SIL777	Secure Programming Methodologies	3	0	2	4	COL862	Special Topics in Software Systems	3	0	0	3
SIL779	Data Privacy	3	0	0	3	COV889	Special Module in Concurrency	1	0	0	1
SIV810	Special Module in Cyber Security	1	0	1	1.5	COL812	System Level Design and Modelling	3	0	0	3
SIV812	Special Module in Computer Forensics	1	0	1	1.5	ELV710	Special Module in Cyber Security	1	0	0	1
SIV814	Special Module in Application Security	1	0	1	1.5	ELL720	Advanced Digital Signal Processing	3	0	0	3
Streamed Electives(JCS) in Cryptography and Cryptanalysis						ELL733	Digital ASIC Design	3	0	2	4
JCS816	Independent Study	0	3	0	3	ELL748	System-on-Chip Design and Test	3	0	0	3
COL730	Parallel Programming	3	0	2	4	ELL765	Smart Grid Technology	3	0	0	3
COL774	Machine Learning	3	0	2	4	ELL772	Planning and Operation of Smart Grid	3	0	0	3
COL864	Special Topics in Artificial Intelligence	3	0	0	3	ELL787	Embedded Systems and Applications	3	0	0	3
COL865	Special Topics in Computer Applications	3	0	0	3	ELL880	Special Topics in Computers-I	3	0	0	3
COL870	Special Topics in Machine Learning	3	0	0	3	ELL881	Special Topics in Computers-II	3	0	0	3
COL872	Special Topics in Cryptography	3	0	0	3	ELL883	Embedded Intelligence	3	0	0	3
COV878	Special Module in Machine Learning	1	0	0	1	MSL855	Electronic Commerce	3	0	0	3
COV884	Special Module in Artificial Intelligence	1	0	0	1	MSL878	Electronic Payments	1.5	0	0	1.5
ELL710	Coding Theory	3	0	0	3	MSL893	Public Policy Issues in the Information Age	1.5	0	0	1.5
ELL712	Digital Communications	3	0	0	3	SIV810	Special Module in Cyber Security	1	0	1	1.5
ELL711	Signal Theory	3	0	0	3	SIV814	Special Module in Application Security	1	0	1	1.5
ELL718	Statistical Signal Processing	3	0	0	3	SIL771	Special Topics in Cyber Security	3	0	0	3
ELL720	Advanced Digital Signal Processing	3	0	0	3	SIL773	Digital Watermarking and Steganography	3	0	0	3
ELL800	Numerical Linear Algebra and Optimization in Engineering	3	0	0	3	SIL775	Biometric Security	3	0	0	3
ELL880	Special Topics in Computers-I	3	0	0	3	SIL777	Secure Programming Methodologies	3	0	2	4
ELL881	Special Topics in Computers-II	3	0	0	3	SIL781	Secure Hardware-based Systems Design	3	0	2	4
MTL729	Comp. Algebra & its Applications	3	0	0	3	SIL763	Introduction to Blockchains, Cryptocurrencies and Smart Contracts	3	0	2	4

Master of Technology in Energy Studies

Interdisciplinary Programme

The overall credits structure

Category	PC	PE	OE	Total
Credits	30	18	06	54

Program Core

ESL710	Energy, Ecology and Environment	3	0	0	3
ESL711	Fuel Technology	3	0	0	3
ESL720	Energy Conservation	3	0	0	3
ESL730	Direct Energy Conversion	3	0	0	3
ESL740	Non-conventional Sources of Energy	3	0	0	3
ESL750	Economics and Planning of Energy Systems	3	0	0	3
ESL760	Heat Transfer	3	0	0	3
ESP713	Energy Laboratory	0	0	6	3
JSD801	Major Project Part – 1 (JES)	0	0	12	6
Total Credits				30	

ESL768	Wind Energy and Hydro Power Systems	3	0	0	3
ESL770	Solar Energy Utilization	3	0	0	3
ESL796	Operation and Control of Electrical Energy Systems	3	0	0	3
ESL810	MHD Power Generation	3	0	0	3
ESL840	Solar Architecture	3	0	0	3
ESL850	Solar Refrigeration and Air Conditioning	3	0	0	3
ESL860	Electrical Power Systems Analysis	3	0	0	3
ESL870	Fusion Energy	3	0	0	3
ESL871	Advanced Fusion Energy	3	0	0	3
ESL880	Solar Thermal Power Generation	3	0	0	3
JSD799	Minor Project (JES)	0	0	6	3
JSD802	Major Project Part – 2 (JES)	0	0	24	12
JSS801	Independent Study (JES)	0	3	0	3

Program Electives

ESL714	Power Plant Engineering	3	0	0	3
ESL718	Power Generation, Transmission and Distribution	3	0	0	3
ESL722	Integrated Energy Systems	3	0	0	3
ESL732	Bioconversion and Processing of Waste	3	0	0	3
ESL734	Nuclear Energy	3	0	0	3
ESL737	Plasma Based Materials Processing	3	0	0	3
ESL746	Hydrogen Energy	3	0	0	3
ESL755	Solar Photovoltaic Devices and Systems	3	0	0	3

Program Electives (other Departments)

MEL815	Applied Combustion	2	0	2	4
MEL816	Analysis of I.C. Engine Processes	3	0	2	4
EEL748	Power Quality	3	0	0	3
EEL899	Distribution Automation	3	0	0	3
CHL722	Fundamentals of Fuel Cell Technology	3	0	2	4

Sem.	Courses (Number, Abbreviated Title, L-T-P, Credits)					Lecture Courses	Contact h/week				Credits
	L	T	P	Total							
I	ESL740 Non-conventional Sources of Energy (3-0-0) 3	ESL711 Fuel Technology (3-0-0) 3	ESL760 Heat Transfer (3-0-0) 3	ESL720 Energy Conservation (3-0-0) 3	PE-1 (3-0-0) 3	5	15	0	0	15	15
II	ESL750 Economics and Planning of Energy Systems (3-0-0) 3	ESL710 Energy, Ecology and Environment (3-0-0) 3	ESP713 Energy Laboratory (0-0-6) 3	ESL730 Direct Energy Conversion (3-0-0) 3	PE-2 (3-0-0) 3	4	12	0	6	18	15
Summer	JSD801 Major Project Part-1 (JES)					0					
III	JSD801 Major Project Part-I (JES) (0-0-12) 6	OE-1 (3-0-0) 3	OE-2 (3-0-0) 3			2	6	0	12	18	12
IV	JSD802 Major Project Part-2 (JES) (0-0-24) 12					0	0	0	24	24	12
	PE-3 (3-0-0) 3	PE-4 (3-0-0) 3	PE-5 (3-0-0) 3	PE-6 (3-0-0) 3		4	12	0	0	12	

NOTE: for part time students, the above credits would be completed over 6 semesters with the Major Project Part I & II being offered in the 5th and 6th semesters respectively

Total = 54

Master of Technology in Energy & Environment Technologies and Management

Interdisciplinary Programme

The overall credits structure

Category	PC	PE	OE	Total
Credits	30	18	06	54
Bridge (Audit) Courses	1	0	0	1

Program Core

ESL711	Fuel Technology	3	0	0	3
ESL715	Electrical Energy Management Systems	3	0	0	3
ESL727	Energy and Environment	3	0	0	3
ESL740	Non-conventional Sources of Energy	3	0	0	3
ESL774	Quantitative Methods for Energy Management and Planning	3	0	0	3
ESL776	Industrial Energy and Environment Analysis	3	0	0	3
ESL784	Cogeneration and Energy Efficiency	3	0	0	3
ESP728	Energy & Environment Laboratory	0	0	6	3
ESD801	Major Project Part – 1 (ESN)	0	0	12	6

Compulsory (Audit) Courses (CA)

ESN704	Basic Thermal Engineering	1	0	0	0
ESN712	Basic Electrical Engineering	1	0	0	0

Total Credits 30

Program Electives

ESL724	Energy Audit	3	0	0	3
ESL733	Organic Waste to Energy Conversion Technology	3	0	0	3
ESL735	Hazardous Waste Management	3	0	0	3
ESL738	Power System Planning and Operation	3	0	0	3
ESL742	Economics and Financing of Renewable Energy Systems	3	0	0	3
ESL743	Optimal Design of Energy Systems	3	0	0	3
ESL744	Plasmas for Energy and Environment	3	0	0	3
ESL745	Environmental Audit and Impact Assessment	3	0	0	3
ESL749	Developing Energy Efficiency and Renewable Energy Projects	3	0	0	3
ESL752	Carbon Audit and Management	3	0	0	3
ESL754	Nanomaterials for Energy Applications	3	0	0	3
ESL756	Energy Policy and Planning	3	0	0	3
ESL758	Carbon Capture and Storage	3	0	0	3
ESL764	Environmental Economics	3	0	0	3
ESL766	Environmental Regulations	3	0	0	3
ESL771	Instrumentation and Control in Energy Systems	3	0	0	3

ESL772 Energy Storage 3 0 0 3

Program Electives/Open Electives

ESL773	Battery Storage	3	0	0	3
ESL778	Industrial Waste Management and Recycling	3	0	0	3
ESL780	Zero Emission Vehicles	3	0	0	3
ESL782	Emission Control in Internal Combustion Engines	3	0	0	3
ESL796	Operation & Control of Electrical Energy Systems	3	0	0	3
ESL797	Operation of Electrical Energy Systems with Large Scale Integration of Renewable Energy Sources.	3	0	2	4
ESL798	Distributed and Decentralized Energy Systems	3	0	0	3
ESL804	Pollution Control in Power Plants	3	0	0	3
ESL875	Alternative Fuels for Transportation	3	0	0	3
ESV891	Special Topics on Emerging Trends in Energy and Environmental Technologies	1	0	0	1
ESD799	Minor Project (ESN)	0	0	6	3
ESS801	Independent Study (ESN)	0	3	0	3
ESD802	Major Project Part – 2 (ESN)	0	0	24	12

Program Electives (other Departments)

CLL723	Hydrogen energy and Fuel Cell Technology	3	0	0	3
CLL724	Environmental Engg. and Waste Mgmt.	3	0	0	3
CLL725	Air Pollution Control Engineering	3	0	0	3
CLL706	Petroleum Production Engineering	3	0	0	3
CLL794	Petroleum Refinery Engineering	3	0	0	3
CVL820	Environmental Impact Assessment	3	0	0	3
CVL822	Emerging Technologies for Environmental Mgmt.	3	0	0	3
CVL823	Thermal Techniques for Waste Mgmt.	3	0	0	3
CVL824	Life Cycle Analysis & Design for Environment	3	0	0	3
CVL721	Solid Waste Engineering	3	0	0	3
CVL720	Air Pollution and control	3	0	0	3
CVL847	Transportation Economics	3	0	0	3
ELL765	Smart Grid Technology	3	0	0	3
MCL812	Combustion	3	0	0	3
MCL825	Design of Wind Power Farms	3	0	0	3
PYL727	Energy Materials and Devices	3	0	0	3

Sem.	Courses (Number, Abbreviated Title, L-T-P, credits)						Lecture courses	Contact h/week				Credits
	L	T	P	Total	L	T		P	Total			
I	ESL740 Non-conventional Sources of Energy (3-0-0) 3	ESL711 Fuel Technology (3-0-0) 3	ESL715 Electrical Energy Mgmt. Systems (3-0-0) 3	ESL727 Energy and Environment (3-0-0) 3	PE-1 (3-0-0) 3	ESN704 Basic Thermal Engineering/ ESN712 Basic Electrical Engineering (1-0-0) 0	6	16	0	0	16	15
II	ESL776 Industrial Energy and Environment Analysis (3-0-0) 3	ESL784 Cogeneration and Energy Efficiency (3-0-0) 3	ESP728 Energy & Environment Laboratory (0-0-6) 3	ESL774 Quantitative Methods for Energy Mgmt. and Planning (3-0-0) 3	PE-2 (3-0-0) 3		4	12	0	6	18	15
Summer	ESD801 Major Project Part I											
III	ESD801 Major Project Part-I (0-0-12) 6	OE-1 (3-0-0) 3	OE-2 (3-0-0) 3				2	6	0	12	18	12
IV	ESD802 Major Project Part-II (0-0-24) 12						0	0	0	24	24	12
	PE-3 (3-0-0) 3	PE-4 (3-0-0) 3	PE-5 (3-0-0) 3	PE-6 (3-0-0) 3			4	12	0	0	12	

NOTE: for part time students, the above credits would be completed over 6 semesters with the Major Project Part I & II being offered in the 5th and 6th semesters respectively

Total = 54

Master of Technology in Renewable Energy Technologies and Management
Interdisciplinary Programme

The overall credits structure

Category	PC	PE	OE	Total
Credits	27	24	0	51
Bridge (Audit) Courses	0-4	0	0	0-4

Program Core

ESL739	Bio-energy : Resources, Technologies and Applications				3	0	0	3	ESL746	Hydrogen Energy	3	0	0	3
ESL742	Economics and Financing of Renewable Energy Systems		3	0	0	3		ESL749	Developing Energy Efficiency and Renewable Energy Projects	3	0	0	3	
ESL753	Solar Thermal Technologies and Systems		3	0	0	3		ESL751	Renewable Energy Resource Assessment and Forecasting	3	0	0	3	
ESL755	Solar Photovoltaic Devices and Systems		3	0	0	3		ESL752	Carbon Audit and Management	3	0	0	3	
ESL768	Wind Energy and Hydro Power Systems		3	0	0	3		ESL756	Energy Policy and Management	3	0	0	3	
ESP705	Renewable Energy Laboratory		0	0	6	3		ESL757	Energy Policy and Planning	3	0	0	3	
ESD798	Minor Project (ESR)		0	0	6	3		ESL771	Instrumentation and Control in Energy Systems	3	0	0	3	
ESD851	Major Project – 1 (ESR)		0	0	12	6		ESL772	Energy Storage	3	0	0	3	

Bridge (Audit) Courses (BA): (Based on Student's background and preparedness)

ESN702	Introduction to Project Management		1	0	0	0		ESL774	Quantitative Methods for Energy Mgmt. & Planning	3	0	0	3	
ESN703	Technical Writing		1	0	0	0		ESL780	Zero Emission Vehicles	3	0	0	3	
ESN704	Basic Thermal Engineering (for non-mechanical students)		1	0	0	0		ESL790	Policy and Regulatory Aspects of Power System Operation with Increasing Renewable Energy Share	3	0	0	3	
ESN712	Basic Electrical Engineering (for non-electrical students)		1	0	0	0		ESL791	Renewable energy Integration and Power Systems	3	0	0	3	
ESN791	Applied Mathematics and Computational Methods		1	0	0	0		ESL796	Operation and Control of Electrical Energy Systems	3	0	0	3	
Total Credits						27		ESL797	Operation of Electrical Energy Systems with Large Scale Integration of Renewable Energy Sources	3	0	2	4	

Program Electives

ESL718	Power Generation, Transmission and Distribution		3	0	0	3		ESL840	Solar Architecture	3	0	0	3	
ESL729	Renewable Energy and Environment		3	0	0	3		ESL842	Negative CO ₂ Emission Technologies	3	0	0	3	
ESL730	Direct Energy Conversion		3	0	0	3		ESL845	Net Zero Energy Buildings	3	0	0	3	
ESL732	Bioconversion and Processing of Waste		3	0	0	3		ESL850	Solar Refrigeration and Air-conditioning	3	0	0	3	
ESL737	Plasma Based Materials Processing		3	0	0	3		ESL852	Emerging Materials for Next Generation Photovoltaic Applications	3	0	0	3	
ESL744	Plasma for Energy and Environment		3	0	0	3		ESL855	Solar Photovoltaic Power Generation	3	0	0	3	

FULL TIME (4-Semester Schedule)

Sem.	Courses (Number, Abbreviated Title, L-T-P, credits)							Lecture courses	Contact h/week				Credits
	L	T	P	Total	L	T	P		Total				
I	ESL739 Bio-energy : Resources, Technologies & Applications (3-0-0) 3	ESL742 Economics and Financing of Renewable Energy Systems (3-0-0) 3	ESL755 Solar Photovoltaic Devices and Systems (3-0-0) 3	ESL753 Solar Thermal Technologies and Systems (3-0-0) 3	PE-1 (3-0-0) 3	BA-1 (1-0-0) 0 [If required]	BA-2 (1-0-0) 0 [If required]	5-7	15-17	0	0	15-17	15
II	ESP705 Renewable Energy Laboratory (3-0-0) 3	ESL768 Wind Energy and Hydro Power Systems (3-0-0) 3	PE-2 (3-0-0) 3	PE-3 (3-0-0) 3	PE-4 (3-0-0) 3	BA-3 (1-0-0) 0 [If required]	BA-4 (1-0-0) 0 [If required]	4-6	12-14	0	6	18-20	15
Summer	Internship and ESD801 [Major Project Part-I (0-0-12) 6]												
III	ESD851 Major Project Part-I (ESR) (0-0-12) 6 [and Internship]					ESD798 Minor Project (ESR) (0-0-6) 3		0	0	0	18	18	09
IV	ESD852 Major Project Part-II (ESR) (0-0-24) 12 [with option to carry out in the home country for a foreign national student with provision for presentations through video conference]							0 or 4	0 or 12	0	0 or 24	12 or 24	12
	PE-5 (3-0-0) 3	PE-6 (3-0-0) 3	PE-7 (3-0-0) 3		PE-8 (3-0-0) 3								

* Possibility of inviting foreign students about a month in advance to take bridge courses is being explored

Total = 51

ESL875	Alternative Fuels for Transportation	3	0	0	3	Program Electives (From outside Centre)					
ESL880	Solar Thermal Power Generation	3	0	0	3	ASL760	Renewable Energy Meteorology	3	0	0	3
ESL885	Solar Industrial Process Heating	3	0	0	3	CLL723	Hydrogen Energy and Fuel Cell Technology	3	0	0	3
ESP706	Renewable Energy Simulation Laboratory	0	0	6	3	EEL758	Power Quality	3	0	0	3
ESV891	Special Topics on Emerging Trends in Energy and Environmental Technologies	1	0	0	1	EEL765	Smart Grid Technology	3	0	0	3
ESS851	Independent Study (ESR)	0	3	0	3	MCL825	Design of Wind Power Farms	3	0	2	4
ESD852	Major Project Part – 2 (ESR)	0	0	24	12	PYL727	Energy Materials and Devices	3	0	0	3

PART TIME (6-Semester Schedule)

Sem.	Courses (Number, Abbreviated Title, L-T-P, credits)				Lecture courses	Contact h/week				Credits
	L	T	P	Total						
I	ESL739 Bio-energy : Resources, Technologies & Applications (3-0-0) 3	ESL742 Economics and Financing of Renewable Energy Systems (3-0-0) 3	ESL753 Solar Thermal Technologies and Systems (3-0-0) 3	BA-1 (1-0-0) 0 [If required]	3-4	9-10	0	0	9-10	9
II	ESL768 Wind Energy and Hydro Power Systems (3-0-0) 3	ESP705 Renewable Energy Laboratory (0-0-6) 3	ESL755 Solar Photovoltaic Devices and Systems (3-0-0) 3	BA-2 (1-0-0) 0 [If required]	2-3	6-7	0	6	9-10	9
Summer										
III	PE-1 (3-0-0) 3	PE-2 (3-0-0) 3	BA-3 (1-0-0) 0 [If required]		2-3	6-7	0	0	6-7	6
IV	PE-3 (3-0-0) 3	PE-4 (3-0-0) 3	BA-4 (1-0-0) 0 [If required]		2-3	6-7	0	6	6-7	6
Summer	Internship and ESD851 [Major Project Part-I (0-0-12) 6]									
V	ESD851 Major Project Part-I (0-0-12) 6 [and Internship]			ESD798 Minor Project (0-0-6) 3	0	0	0	18	18	9
VI	ESD852 Major Project Part (0-0-24) 12				0 or 4	0 or 12	0	0 or 24	12 or 24	12
	PE-5 (3-0-0) 3	PE-6 (3-0-0) 3	PE-7 (3-0-0) 3	PE-8 (3-0-0) 3						

Total = 51

Master of Technology in Industrial Tribology and Maintenance Engineering Interdisciplinary Programme

The overall credits structure

Category	PC	PE	OE	Total
Credits	33	09	06	48

Program Core

ITL702	Diagnostic Maintenance and Condition Monitoring	3	0	2	4	ITL710	Design of Tribological Elements	3	0	0	3
ITL703	Fundamentals of Tribology	3	0	2	4	ITL711	Reliability, Availability and Maintainability (RAM) Engineering	3	0	0	3
ITL705	Materials for Tribological Applications	3	0	0	3	ITL717	Corrosion and its Control	3	0	0	3
ITL714	Failure Analysis and Repair	3	0	2	4	ITL730	Lubricants	2	0	2	3
JIT801	Major Project Part-I (JIT)	0	0	12	6	ITL740	Risk Analysis and Safety	2	1	0	3
JIT802	Major Project Part-II (JIT)	0	0	24	12	ITL752	Bulk Materials Handling	2	0	2	3
	Total Credits				33	ITL760	Noise Monitoring and Control	2	0	2	3
						ITL810	Bearing Lubrication	3	0	0	3
						JIS800	Independent Study	0	3	0	3
						JID800	Minor Project	0	0	6	3

Program Electives

ITL709	Maintenance Planning and Control	3	0	0	3
--------	----------------------------------	---	---	---	---

Sem.	Courses (Number, Abbreviated Title, L-T-P, Credits)						Lecture courses	Contact h/week				Credits
	L	T	P	Total	L	T		P	Total			
I	ITL703 Fundamentals of Tribology (3-0-2) 4	ITL705 Materials for Tribological Applications (3-0-0) 3			PE-1 (3-0-0) 3	OE-1 (3-0-0) 3	4	12	0	2	14	13
II	ITL702 Diagnostic Maintenance & Condition Monitoring (3-0-2) 4	ITL714 Failure Analysis & Repair (3-0-2) 4			PE-2 (3-0-0) 3	PE-3 (3-0-0) 3	4	12	0	4	16	14
III	JID801 Major Project Part-I (JIT) (0-0-12) 6				OE-2 (3-0-0) 3		1	3	0	12	15	9
IV	JID802 Major Project Part-II (JIT) (0-0-24) 12						0	0	0	24	24	12

Total = 48

Master of Technology in Instrument Technology Interdisciplinary Programme

The overall credits structure

Category	PC	PE	OE	Total
Credits	39	15	0	54

Program Core

DSD801	Major Project Part-I		0	0	12	MCL783	Automation in Manufacturing	3	0	2	4
DSD802	Major Project Part-II		0	0	24	PYL755	Basic optics and optical instrumentation	3	0	0	3
DSL711	Sensors and Transducers		3	0	0	PYL780	Diffractive and micro optics	3	0	0	3
DSL712	Electronic Techniques for Signal Conditioning and Interfacing		3	0	0	PYL790	Integrated Optics	3	0	0	3
DSL714	Instrument Design and Simulations		2	0	2	PYL792	Optical Electronics	3	0	0	3
DSL731	Optical Components and Basic Instruments		3	0	0	PYL793	Photonic Devices	3	0	0	3
DSL734	Laser Based Instrumentation		3	0	0	PYP761	Optical fabrication and metrology laboratory	0	0	6	3
DSP703	Instrument Technology Laboratory-I		0	0	6	CRL725	Technology of RF and Microwave Solid State Devices	3	0	0	3
DSP704	Instrument Technology Laboratory-II		0	0	6	DSC812	Term Paper and Seminar	0	3	0	3
Total Credits					39	DSL601	Electronic Components and Circuits (for non-electrical students only)	3	0	0	3

Program Electives

ELL746	Biomedical Electronics		3	0	0	3	DSL603	Material and Mechanical Design (for electrical students only)	3	0	0	3
ELL783	Operating System		3	0	2	4	DSL722	Precision Measurement Systems	3	0	0	3
ELL787	Embedded Systems and Applications		3	0	0	3	DSL733	Optical Material and Optical Techniques in Instrumentation	2	0	2	3
ELL735	Analog Integrated Circuits		3	0	0	3	DSL737	Display Devices and Technology	3	0	0	3
ELL734	MOS VLSI design		3	0	0	3	DSL740	Instrument Organization and Ergonomics	2	0	2	3
ELL784	Introduction to Machine Learning		3	0	0	3	DSL811	Selected Topics in Instrumentation-I	3	0	0	3
ELL883	Embedded Intelligence		3	0	0	3	DSL814	Selected Topics in Instrumentation-II	3	0	0	3
MCL705	Experimental Methods		3	0	2	4	DSL815	Special Topics in Instrumentation	1	0	0	1
MCL749	Mechatronic Product Design		3	0	2	4	DSP705	Advanced Instrument Technology Lab	0	0	6	3
MCL781	Machining Processes and Analysis		3	0	2	4	DSS720	Independent Study	0	3	0	3

Sem.	Courses (Number, Abbreviated Title, L-T-P, Credits)					Lecture courses	Contact h/week				Credits
	L	T	P	Total							
I	DSP703 Instrument Technology Laboratory-I (0-0-6) 3	DSL711 Sensors and Transducers (3-0-0) 3	DSL731 Optical Components and Basic Instruments (3-0-0) 3	DSL601*/ DSL603** Electronic Components and Circuits/Material and Mechanical Design (3-0-0) 3	PE-1 (3-0-0) 3	4	12	0	6	18	15
II	DSP704 Instrument Technology Laboratory-II (0-0-6) 3	DSL712 Electronic Techniques for Signal Conditioning and Interfacing (3-0-0) 3	DSL714 Instrument Design and Simulations (2-0-2) 3	DSL734 Laser Based Instrumentation (3-0-0) 3	PE-2 (3-0-0) 3	4	11	0	8	19	15
Summer											
III	DSD801 (0-0-12) 6	PE-3 (3-0-0) 3	PE-4 (3-0-0) 3			2	6	0	12	18	12
IV	DSD802 (0-0-24) 12					0	0	0	24	24	12

*For students with non-electrical Engineering, Electronics, Instrumentation, Electronics and Communication background.

**For students with Electrical Engineering, Electronics, Instrumentation, Electronics and Communication background.

Total = 54

Master of Technology in Optoelectronics and Optical Communication
Interdisciplinary Programme

The overall credits structure

Category	PC	PE	OE	Total
Credits	24	27	0	51

Program Core

ELL717	Optical Communication Systems	3	0	0	3	ELL817	Access Networks	3	0	0	3
ELL727	Digital Communication & Information Systems	3	0	0	3	ELL819	Introduction to Plasmonics	3	0	0	3
JOD801	Major Project Part-I	0	0	12	6	ELL820	Photonic Switching and Networking	3	0	0	3
JOP791	Laboratory-I (Fiber Optics Lab/Opt. Comm. Lab)	0	0	6	3	JOD802	Major Project Part-II	0	0	24	12
JOP792	Laboratory-II (Fiber Optics Lab/Opt. Comm. Lab)	0	0	6	3	JOL793	Selected Topics-I	3	0	0	3
PYL791	Fiber Optics	3	0	0	3	JOL794	Selected Topics-II	3	0	0	3
PYL792	Optical Electronics	3	0	0	3	JOS795	Independent Study	0	3	0	3
Total Credits		24				JOV796	Selected Topics in Photonics	1	0	0	1
						PYL756	Fourier optics and holography	3	0	0	3
						PYL757	Statistical and Quantum optics	3	0	0	3

Program Electives

ELL716	Telecommunication Switching and Transmission	3	0	0	3	PYL760	Biomedical optics and Bio-photonics	3	0	0	3
ELL720	Advanced Digital Signal Processing	3	0	0	3	PYL770	Ultra-fast optics and applications	3	0	0	3
ELL723	Broadband Communication Systems	3	0	0	3	PYL771	Green Photonics	3	0	0	3
ELL724	Computational Electromagnetics	3	0	0	3	PYL790	Integrated Optics	3	0	0	3
ELL726	Nano-Photonics and Plasmonics	3	0	0	3	PYL793	Photonic Devices	3	0	0	3
ELL728	Optoelectronic Instrumentation	3	0	0	3	PYL795	Optics and Lasers	3	0	0	3
ELL785	Computer Communication Networks	3	0	0	3	PYL891	Fiber Optic Components and Devices	3	0	0	3
ELL814	Wireless Optical Communications	3	0	0	3	PYL892	Guided Wave Photonic Sensors	3	0	0	3

Sem.	Courses (Number, Abbreviated Title, L-T-P, Credits)						Lecture courses	Contact h/week				Credits
	L	T	P	Total								
I	PYL791 Fibre Optics (3-0-0) 3	ELL727 Digital Comm. & Information Systems (3-0-0) 3	JOP791 Laboratory-I (Fibre Optics Lab/Opt. Comm. Lab) (0-0-6) 3	PYL/ELL PE-1 (3-0-0) 3	PYL/ELL PE-2 (3-0-0) 3		4	12	0	6	18	15
II	PYL792 Optical Electronics (3-0-0) 3	ELL717 Optical Communication System (3-0-0) 3	JOP792 Laboratory-II (Fibre Optics Lab/Opt. Comm. Lab) (0-0-6) 3	PYL/ELL PE-3 (3-0-0) 3	PYL/ELL PE-4 (3-0-0) 3		4	12	0	6	18	15
Summer												
III	PYL/ELL PE-5 (3-0-0) 3	JOD801 Major Project Part-I (0-0-12) 6					1	3	0	12	15	9
IV	JOD802 Major Project Part-II Or 12 Credits PE Courses in lieu of Major Project Part-II) (0-0-24) 12						0	0	0	24	24	12

Total = 51

Master of Technology in Telecommunication Technology & Management

Interdisciplinary Programme

The overall credits structure

Category	PC	PE	OE	Total
Credits	33	21	0	54

Program Core

ELL711	Signal Theory	3	0	0	3
ELL712	Digital Communications	3	0	0	3
ELL785	Computer Communication Networks	3	0	0	3
ELL818	Telecommunication Technologies	3	0	0	3
ELP718	Telecommunication Software Laboratory	0	1	4	3
ELP720	Telecommunication Networks Laboratory	0	1	4	3
ELP725	Wireless Communication Laboratory	0	1	4	3
JTD792	Minor Project	0	0	6	3
JTD801	Major Project-I	0	0	12	6
MSL723	Telecommunications Systems Management	3	0	0	3
Total Credits				33	

Program Electives

ELL723	Broadband Communication Systems	3	0	0	3
--------	---------------------------------	---	---	---	---

Streamed Electives (JTM) in (Signal and Information Processing)

ELL715	Digital Image Processing	3	0	2	4
ELL718	Statistical Signal Processing	3	0	0	3
ELL720	Advanced Digital Signal Processing	3	0	0	3
ELL784	Introduction to Machine Learning	3	0	0	3
ELL786	Multimedia Systems	3	0	0	3
ELL792	Computer Graphics	3	0	0	3
ELL793	Computer Vision	3	0	0	3
ELL823	Selected Topics in Information Processing-I	3	0	0	3
CRL707	Human & Machine Speech Communication	3	0	0	3

Streamed Electives (JTM) in (Communication Systems)

ELL710	Coding Theory	3	0	0	3
ELL714	Basic Information Theory	3	0	0	3
ELL717	Optical Communication Systems	3	0	0	3
ELL718	Statistical Signal Processing	3	0	0	3
ELL719	Detection and Estimation Theory	3	0	0	3
ELL720	Advanced Digital Signal Processing	3	0	0	3
ELL813	Advanced Information Theory	3	0	0	3
ELL814	Wireless Optical Communications	3	0	0	3
ELL815	MIMO Wireless Communications	3	0	0	3
ELL816	Satellite Communication	3	0	0	3
ELL824	Selected Topics in Information Processing-II	3	0	0	3

Streamed Electives (JTM) in (Telecom Management)

MSL700	Fundamentals of Management of Technology	3	0	0	3
MSL701	Strategic Technology Management	2	0	2	3
MSL707	Management Accounting	3	0	0	3
MSL713	Information Systems Management	2	0	2	3
MSL726	Telecom Systems Analysis, Planning and Design	3	0	0	3
MSL728	International Telecommunication Management	3	0	0	3
MSL760	Marketing Management	2	0	2	3

MSL815	Decision Support and Expert Systems	2	0	2	3
MSL850	Management of Information Technology	3	0	0	3

Streamed Electives (JTM) in (Telecom Analytics)

COL762	Database Implementation	3	0	2	4
ELL784	Introduction to Machine Learning	3	0	0	3
ELL791	Neural Systems and Learning Machines	3	0	2	4
ELL795	Swarm Intelligence	3	0	0	3
ELL798	Agent Technologies	3	0	0	3
ELL882	Large-Scale Machine Learning	3	0	0	3
ELL884	Information Retrieval	3	0	0	3
ELL886	Big Data Systems	3	0	0	3
ELL887	Cloud Computing	3	0	0	3
ELL888	Advanced Machine Learning	3	0	0	3
ELL892	Internet Technologies	3	0	0	3

Streamed Electives (JTM) in (Embedded Systems and Network Appliance Engineering)

COL719	Synthesis of Digital Systems	3	0	2	4
COL740	Software Engineering	3	0	2	4
ELL766	Appliance Systems	3	0	0	3
ELL787	Embedded Systems and Applications	3	0	0	3
ELL790	Digital Hardware Design	3	0	0	3
ELL887	Cloud Computing	3	0	0	3
ELL898	Pervasive Computing	3	0	0	3
ELL899	Testing and Fault Tolerance	3	0	0	3
ELP721	Embedded Telecommunication Systems Laboratory	0	1	4	3
ELP781	Digital Systems Lab	0	1	4	3

Streamed Electives (JTM) in (Computer and Communication Networks)

COL724	Advanced Computer Networks	3	0	2	4
ELL716	Telecommunication Switching and Transmission	3	0	0	3
ELL725	Wireless Communications	3	0	0	3
ELL816	Satellite Communication	3	0	0	3
ELL817	Access Networks	3	0	0	3
ELL820	Photonic Switching and Networking	3	0	0	3
ELL887	Cloud Computing	3	0	0	3
ELL889	Protocol Engineering	3	0	0	3
ELL892	Internet Technologies	3	0	0	3
ELL894	Network Performance Modeling and Analysis	3	0	0	3
ELL895	Network Security	3	0	0	3
ELL896	Mobile Computing	3	0	0	3
ELL897	Network Management	3	0	0	3
ELL898	Pervasive Computing	3	0	0	3
ELP782	Computer Networks Lab	0	1	4	3
ELP821	Advanced Telecommunication Networks Laboratory	0	1	4	3
ELP822	Network Software Laboratory	0	1	4	3

Sem.	Courses (Number, Abbreviated Title, L-T-P, Credits)					Lecture courses	Contact h/week				Credits
	L	T	P	Total							
I	ELL711 Signal Theory (3-0-0) 3	ELL712 Digital Communication (3-0-0) 3	ELL818 Telecom. Technologies (3-0-0) 3	ELP718 Telecom. Software (0-1-4) 3	ELL785 Computer Comm. Networks (3-0-0) 3	4	12	1	4	17	15
II	ELP725 Wireless Comm. Lab (0-1-4) 3	ELP720 Telecom. Network Lab (0-1-4) 3	JTD792 Minor Project (JTM) (0-0-6) 3	MSL723 Telecom Syst. Mgmt. (3-0-0) 3	PE-1 (3-0-0) 3	2	6	2	14	22	15
Summer											
III	JTD801 Major Project Part-I (JTM) (0-0-12) 6	PE-2 (3-0-0) 3	PE-3 (3-0-0) 3			2	6	0	12	18	12
IV (Course based) OR	PE-3 (3-0-0) 3	PE-3 (3-0-0) 3	PE-4 (3-0-0) 3	PE-5 (3-0-0) 3		4	12	0	0	12	12
IV (Project based)	JTD802 Major Project Part-II (JTM) (0-0-24) 12					0	0	0	24	24	12

Total = 54

Master of Technology in VLSI Design Tools and Technology

Interdisciplinary Programme

The overall credits structure

Category	PC	PE	OC	Total
Credits	18	30	0	48

Program Core

ELL734	MOS VLSI design	3	0	0	3
ELP736	Physical Design Laboratory	0	0	6	3
JVD811	Major Project-I	0	0	24	12
Total Credits				18	

Program Electives

BSP710	Communication & Signal Processing Tech. Lab.	0	1	4	3
COL702	Advanced Data Structures	3	0	2	4
COL718	Architecture of High Performance Computers	3	0	2	4
COP820	Processor Design Lab	0	0	8	4
ELL737	Flexible Electronics	3	0	0	3
ELL742	Introduction to MEMS Design	3	0	0	3
ELL743	Photovoltaics	3	0	0	3
ELL745	Quantum Electronics	3	0	0	3
ELL746	Biomedical Electronics	3	0	0	3
ELL747	Active and Passive Filter Design	3	0	0	3
ELL830	Issues in Deep Submicron VLSI Design	3	0	0	3
ELL831	CAD for VLSI, MEMS, and Nanoassembly	3	0	0	3
ELL832	Selected Topics in IEC-I	3	0	0	3
ELL833	CMOS RF IC Design	3	0	0	3
ELL883	Embedded Intelligence	3	0	0	3
ELP831	IEC Laboratory-I	0	0	6	3
ELV830	Special Module in Low Power IC Design	1	0	0	1
ELV831	Special Module in VLSI Testing	1	0	0	1
JVD799	Minor Project	0	0	12	
JVD812	Major Project-II	0	0	24	12
JVS801	Independent Study	0	3	0	3

MTL704	Numerical Optimization	3	0	0	3
CRL702	Architectures and Algorithms for DSP Systems	2	0	4	4
CRL711	CAD of RF and Microwave Circuits	3	0	2	4
CRL712	RF and Microwave Active Circuits	3	0	0	3

Streamed Electives (JVL) in (ASIC and SoC Design)

COL719	Synthesis of Digital Systems	3	0	2	4
COL812	System Level Design and Modelling	3	0	0	3
COP745	Digital System Design Laboratory	0	0	6	3
ELL731	Mixed Signal Circuit Design	3	0	0	3
ELL735	Analog Integrated Circuits	3	0	0	3
ELL749	Semiconductor Memory Design	3	0	0	3

Streamed Electives (JVL) in (Micro and Nano Devices)

ELL730	I.C. Technology	3	0	0	3
ELL732	Micro and Nanoelectronics	3	0	0	3
ELL738	Micro and Nano Photonics	3	0	0	3
ELL739	Advanced Semiconductor Devices	3	0	0	3
ELL740	Compact Modeling of Semiconductor Devices	3	0	0	3
ELL744	Electronic and Photonic Nanomaterials	3	0	0	3

Streamed Electives (JVL) in (Embedded Intelligent Systems)

COL788	Advanced Topics in Embedded Computing	3	0	0	3
COL821	Reconfigurable Computing	3	0	0	3
ELL720	Advanced Digital Signal Processing	3	0	0	3
ELL741	Neuromorphic Engineering	3	0	0	3
ELL784	Introduction to Machine Learning	3	0	0	3
ELL797	Energy-Efficient Computing	3	0	0	3

Sem.	Courses (Number, Abbreviated Title, L-T-P, Credits)				Lecture courses	Contact h/week				Credits
	L	T	P	Total						
I	ELP736 Physical Design Laboratory (0-0-6) 3	ELL734 MOS VLSI Design (3-0-0) 3	PE-1 (3-0-0) 3	PE-2 (3-0-0) 3	3	9	0	6	14	12
II	PE-3 (3-0-0) 3	PE-4 (3-0-0) 3	PE-5 (3-0-0) 3	PE-6 (3-0-0) 3	4	12	0	0	12	12
Summer										
III (OR)	JVD811 Major Project-I (0-0-24) 12				0	0	0	24	24	12
IV	JVD812 Major Project-II (0-0-24) 12				0	0	0	24	24	
III (OR)	PE-7 (3-0-0) 3	PE-8 (3-0-0) 3	JVD799 Minor Project (0-0-12) 6		2	6	0	12	18	
IV	JVD811 Major Project-I (0-0-24) 12				0	0	0	24	24	
III (OR)	JVD811 Major Project-I (0-0-24) 12				0	0	0	24	24	
IV	PE-7 (3-0-0) 3	PE-8 (3-0-0) 3	PE-9 (3-0-0) 3	PE-10 (3-0-0) 3	4	12	0	0	12	12

Total = 48

Master of Public Policy

Schools of Public Policy

The overall credits structure

Category	PC	PE	OE	Total
Credits	39	9	6	54

Program Core

SPL703	Research Methods for Public Policy	3	0	0	3
SPL704	Introduction to Public Policy and STI	3	0	0	3
SPL705	Public Institutions in India: Theory and practice	3	0	0	3
SPL706	STI and Sustainable Development	3	0	0	3
SPL707	Tools for Policy Analysis	3	0	0	3
SPL708	Statistics for Public Policy	3	0	0	3
SPL709	Principles of Economics for Public Policy	3	0	0	3
SPL779	Thesis I	0	0	8	4
SPL780	Thesis II	0	0	28	14
Total Credits				39	

Program Electives

SPL711	Modelling Complex Adaptive Systems for Policy Analysis	3	0	0	3
SPL712	Comparative Industrial Policy	3	0	0	3
SPL720	Energy and Infrastructure Finance: A Public Policy Lens	3	0	0	3
SPL721	Perspective on Climate Change: Implications for Policy	3	0	0	3
SPL722	Governance Challenges in Energy Systems in Transition	3	0	0	3
SPL730	Science, Technology & Innovation Policy and Agriculture	3	0	0	3
SPL740	Casual Interference and Impact Assessment	3	0	0	3
SPL741	Socio-Economic Data Analysis	3	0	0	3

Sem.	Courses (Number, Abbreviated Title, L-T-P, Credits)				Lecture courses	Contact h/week				Credits
	L	T	P	Total						
I	SPL704 Introduction to Public Policy and STI (3-0-0) 3	SPL706 STI and Sustainable Development (3-0-0) 3	SPL708 Statistics for Public Policy (3-0-0) 3	SPL709 Principles of Economics for Public Policy (3-0-0) 3	4	12	0	0	12	12
II	SPL705 Public Institutions in India: Theory and practice (3-0-0) 3	SPL707 Tools for Policy Analysis (3-0-0-0) 3	PE-1 (3-0-0) 3	PE-2 (3-0-0) 3	4	12	0	0	12	12
Summer										
III	SPL703 Research Methods for Public Policy (3-0-0) 3	PE-3 (3-0-0) 3	OE-1 (3-0-0) 3	Thesis-I (0-0-8) 4	3	9	0	8	17	13
IV	OE-1 (3-0-0) 3	Thesis-II (0-0-28) 14			1	3	0	28	31	17

Total = 54

11. COURSE DESCRIPTIONS

The details about every course are given in this section. Information about each course includes course number, credits, L-T-P structure, Pre-requisite(s), overlapped courses and course contents.

For some 700 and 800 level courses, the Pre-requisite(s) have been explicitly indicated. Where these are not mentioned, the default Pre-requisite(s) shall be applicable for UG students (see sections 2.6 and 3.11).

For additional information see the website or contact the concerned course coordinator or head of the department/centre/school or the programme coordinator.

Department of Applied Mechanics

APL100 Engineering Mechanics

4 Credits (3-1-0)

Kinematics, Statics, Equations of Motion, Rigid body dynamics, Introduction to variational mechanics.

APL101 Applied Mathematics in Engineering Applications

3 Credits (3-0-0)

Ordinary Differential Equation: Second order ODEs, Method of Undetermined Coefficients, Variation of Parameters, Sturm-Liouville eigenvalue problem, Difference equation. Partial Differential Equation: Classification of PDEs, Heat, Wave and Laplace Equations, Separation of variables to solve PDEs. Fourier Transform: Fourier sine transform, Fourier cosine Transform, Technique for solving ODEs and PDEs. Probability Theory: Axioms of probability, Conditional probability, Random variable, Uncertainty in engineering system, Discrete and Continuous distributions, Distribution function, Joint probability distribution, Moments, Covariance, Correlation coefficient. Stochastic Processes: Definition of Stochastic process, Stochastic FE model, Stationary process, Markov chain, Poisson process.

APL103 Experimental Methods

4 Credits (3-0-2)

Experimental Analysis: Types of measurements and errors, Relative frequency distribution, Histogram, True value, Precision of measurement, Method of least squares, the curve fitting, General linear regression, Theory of errors, Binomial and Gaussian distribution, Chi-square test.

Experimental Methods: Principles of Measurement, Basic Elements of a Measuring Device.

Displacement measurement, Force and Torque Measurement, Temperature Measurement, Pressure Measurement, Fluid Velocity Measurement, Miscellaneous measurements.

Dynamics of Measurements: Dynamic Response of a Measuring Instrument, Response to Transient and Periodic Signals, First and Second order systems as well as their Dynamic Response Characteristics.

Laboratory: The experiments have been designed to understand Experimental Analysis physically. Laboratory will enable the students to apply various statistical methodologies (viz. Mean, Median, Mode, Std Dev. etc) to get the optimum output from the day to day Engineering life experiment.

APL104 Solid Mechanics

4 Credits (3-1-0)

Pre-requisite(s): APL100

Overlaps with: APL105, APL108

Introduction, State of stress at a point, equations of motion, principal stress, maximum shear stress. Concept of strain, strain displacement relations, compatibility conditions, principal strains, transformation of stress/strain tensor, state of plane stress/strain. Constitutive relations, uniaxial tension test, idealized stress-strain diagrams, isotropic linear elastic, viscoelastic and elasto-plastic materials. Energy Methods. Uniaxial stress and strain analysis of bars, thermal stresses, Torsion, Bending and shear stresses in beams, deflection of beams, stability of equilibrium configuration.

APL105 Mechanics of Solids and Fluids

4 Credits (3-1-0)

Pre-requisite(s): APL100

Overlaps with: APL104, APL106, APL107, APL108

Fluid Mechanics MATHEMATICAL PRELIMINARIES: Cartesian Tensors, Index Notation, Integral Theorems. INTRODUCTION: Basic Concepts and Definitions, Solids and Fluids, Internal and external forces on a fluid element. PROPERTIES OF FLUID: Rheological Equation and Classification of fluids, Normal and Shear Stresses, Concept of Pressure, pressure gradient. STATICS OF FLUIDS: Types of Forces on Fluid Element, Mechanics of Fluid at Rest and in rigid body motion, Manometry, forces on fully and partially submerged bodies, stability of a floating body. KINEMATICS OF FLUID MOTION: Types of fluid motion, Stream lines, Streak and path lines, Acceleration and

Rotation of a fluid particle, Vorticity and Circulation, Stream Function, Irrotational flow and Velocity Potential function. DYNAMICS OF AN IDEAL FLUID: Continuity and Euler's Equations of Motion, Bernoulli Equation, Applications to Flow Measurement and other real flow problems. MECHANICS OF VISCOUS FLOW: Navier Stokes equations, exact solutions, Laminar flow through a pipe, Turbulent flow through a pipe, Friction factor, Applications to Pipe Networks. DIMENSIONAL ANALYSIS: Similarity of motion, Dimensionless numbers, Modeling of fluid flows, Applications. INTEGRAL ANALYSIS: Reynolds Transport Theorem, Control Volume Analysis.

Solid Mechanics: State of stress at a point, equations of motion, principal stress, maximum shear stress. Concept of strain, strain displacement relations, compatibility conditions, principal strains, transformation of stress/strain tensor, state of plane stress/strain. Constitutive relations, uniaxial tension test, idealized stress-strain diagrams, isotropic linear elastic and elasto-plastic materials. Energy Methods. Uniaxial stress and strain analysis of bars, thermal stresses, Torsion, Bending, Stability of Equilibrium.

APL106 Fluid Mechanics

4 Credits (3-1-0)

Pre-requisite(s): APL100

Overlaps with: APL107, APL105

Introduction to Fluids and the concept of viscosity, Flow visualization, Fluid Statics, Physical laws for a control volume including continuity, momentum and energy equations, Bernoulli equation, Differential equations of fluid motion, Navier Stokes equations, vorticity and potential flows, dimensional analysis and similitude, Boundary layer theory, 1-D compressible flow.

APL107 Mechanics of Fluids

5 Credits (3-1-2)

Pre-requisite(s): APL100

Overlaps with: APL106, APL105

Introduction to Fluids and the concept of viscosity, Flow visualization, Fluid Statics, Physical laws for a control volume including continuity, momentum and energy equations, Bernoulli equation, Differential equations of fluid motion, Navier Stokes equations, vorticity and potential flows, dimensional analysis and similitude, Boundary layer theory, viscous flow in ducts and applications to turbomachinery. Laboratory experiments will demonstrate the concepts learnt in the theory and appreciation of their limitations.

APL108 Mechanics of Solids

5 Credits (3-1-2)

Pre-requisite(s): APL100

Overlaps with: APL104, APL105

Introduction, State of stress at a point, equations of motion, principal stress, maximum shear stress. Concept of strain, strain displacement relations, compatibility conditions, principal strains, transformation of stress/strain tensor, state of plane stress/strain. Constitutive relations, uniaxial tension test, idealized stress-strain diagrams, isotropic linear elastic, viscoelastic and elasto-plastic materials. Energy Methods. Uniaxial stress and strain analysis of bars, thermal stresses, Torsion, Bending and shear stresses in beams, deflection of beams, stability of equilibrium configuration.

APL190 Design Engineering

4 Credits (3-0-2)

Modern Design Cycle, Craftsman versus Designer, Need Analysis and Broad Engineering Specifications, Concept Design, Feasibility study and Evaluation of alternatives, Engineering Economics, Modelling Techniques-Mathematical, Graphical, iconic, solid, Analysis and Simulation (FEM, Monte Carlo, CFD, Dimensional analysis, Experimental Techniques), Material Selection (strength, stiffness, fatigue life consideration), Manufacturing Processes and Design for Manufacture, Reliability/Availability/Maintainability, Sustainability and Environment, Safety, Ergonomics and Human Factors, Detailed Drawings/Assembly Drawings/Assembly Instructions /Maintenance Manuals, Case Studies.

APL203 Dynamics of Mechanical Systems

4 Credits (3-1-0)

Pre-requisite(s): APL100

Overlaps with: MCL111, MCL731

Principles of Dynamics: Newton's laws and d'Alembert's principle; Energy methods; Generalized Dynamics: Kinematics and Kinetics, Kane's Equations and Lagrange's Equations. Introduction to Vibration with examples; Stability; Balancing; Cams and Gears; Introduction to Multibody Dynamics; Robot Dynamics; Application with Biosystems; Human Body Dynamics.

APL205 Basics of Computer Aided Design

2 Credits (2-0-0)

Pre-requisite(s): APL106 or equivalent, MTL107

Principles of computer aided design, Computer graphics fundamentals, 2D and 3D Transformations and projections, Plane Curves, Space Curves, Synthetic curves. Analytical and parametric surfaces, Synthetic surfaces, Solid Modeling basics, Solid modeling techniques and schemes, Half-spaces, Boundary Representation (B-rep), Constructive Solid Geometry (CSG), Sweep Modeling, Analytical Solid Modeling, Visual Realism, hidden line and surface.

APL206 Engineering Thermodynamics

2 Credits (2-0-0)

Overlaps with: MCL140

Basic concepts and definitions, thermodynamic properties of a pure substance. Work and heat – definition and applications. 1st Law – internal energy and enthalpy, applications to non-flow/closed and flow/open systems (SSSF and USUF). 2nd Law – corollaries, Clausius inequality, entropy. Carnot cycle. Basics of gas-vapor mixtures. Vapor power cycles – Rankine cycle and its modifications. Steam generation and its use – power plants, co-generation, combined cycles. Thermodynamic analysis of fluids in standard fixtures and equipment (piping fixtures, power plants, engines, refrigerators). Equilibrium properties of pure materials and mixtures. Understanding the phase behavior and phase transitions of pure fluids.

APL207 Heat Transfer

2 Credits (2-0-0)

Overlaps with: CLL251, MCL242, ESL760

Modes of heat transfer - conduction, convection, radiation; Basic conservation equations; Conduction: Fourier's law, heat diffusion equation, 1-D steady state conduction in extended surfaces, heat generation, lumped capacitance and 1D transient models, semi-infinite wall. Heat transfer coefficients in natural and forced convection; Convection: Forced and free convection - mass, momentum and energy conservation equations, scaling analysis and significance of non-dimensional numbers, thermal boundary layers, heat transfer in external and internal laminar and turbulent flows and use of correlations. Heat exchanger types and analysis: LMTD and effectiveness-NTU method. Introduction to radiative heat transfer; Radiation: properties, Laws, view factor, 3-surface network for diffuse - gray surfaces. Gas radiation.

APL300 Computational Mechanics

4 Credits (3-0-2)

Pre-requisite(s): APL104/APL105/APL106/APL107/APL108/CHL231

Concept of continuum; introduction to stress, strain and rate of strain tensors; Principal stress and strains; Equation of equilibrium/motion in solid and fluid mechanics; lagrangian and eulerian view point; constitutive equations in the context of both solids and fluids; System of simultaneous linear and non-linear equations: how they arise in mechanics; Determination of constitutive curves; interpolation techniques; Application of numerical integration and differentiation to axial vibration of bars and beams; solution techniques for boundary value problems arising in bending of beams, one dimensional fluid flows and boundary layer equations; stability analysis – computation of eigenvalues; Direct and indirect methods of solution of linear equations; Emphasis will be on using the finite difference method (FDM) to solve problems in solid and fluid mechanics.

APL302 Basics of Product Design

4 Credits (3-0-2)

Overlaps with: APL775

Design Methods- Introduction, identification of customer needs, product specifications, concept generation & selection concept testing, product generation and prototype/model testing. Product Design Human factors in engineering, Man-Machine systems, Human Sensorimotor, Active and Passive Interaction, Sense organs: Capabilities and Limitations, Visual and Auditory Display Systems. Anthropometry, Physical capabilities. Effect of Environment, Air pollution, Motion, Noise Vibrations, Allocation of functions between man and machine, work place design, human error, accidents and safety. Feasibility – Introduction, prefeasibility study, market analysis, technical analysis, financial analysis and feasibility report. Practical – To fabricate a working prototype/model following all the steps of feasibility study preliminary and details design and the concepts of design methods.

APL306 Vibrations

3 Credits (3-0-0)

Pre-requisite(s): APL104

Overlaps with: CVL759, MCL733

Axioms, Euler angles, equations of motion, kinematics and dynamics of constrained rigid bodies. Free vibration response of single-degree-of-freedom (SDOF) systems, undamped and damped vibration. Forced response of SDOF system, response to periodic excitation, impulse response, response to arbitrary excitation, convolution integral, and shock spectrum. Two degrees-of-freedom systems, orthogonality of modes, harmonic response, vibration absorbers. Multi-degrees-of-freedom (MDOF) systems, modal analysis. Continuous systems, axial vibration of rods, bending vibration of beams torsional vibration of rods, Rayleigh-Ritz method, symmetric and antisymmetric modes. Time domain and frequency domain analyses. Numerical methods-extraction of eigenvalues and eigenvectors, time integration techniques.

APD310 Mini Project

3 Credits (0-0-6)

Pre-requisite(s): EC 50

APL310 Constitutive Modeling

4 Credits (3-0-2)

Pre-requisite(s): APL104/APL105/APL108 EC 50

Mathematical Preliminaries (scalar, vector, tensor operation) Thermodynamics (thermodynamical framework for constitutive modeling), Kinematics of Deformation & Motion, Stress-strain principles, Elasticity, Anisotropy, viscoelasticity, multi-physical coupling effect, plasticity, viscoplasticity. Experimental: Experimental characterization, data analysis, Model fitting.

APD311 Project

4 Credits (0-0-8)

Pre-requisite(s): EC 50, 12 Credits of Minor Area in Computational Mechanics

APL311 Introduction to Finite Element Method

4 Credits (3-0-2)

Pre-requisite(s): APL104

Overlaps with: APL705, APL706

Strong and weak forms of governing differential equations, and their equivalence, weighted residual and variational approaches. Ritz method. Discretization of weak form and boundary conditions. Convergence. Bar and beam elements. Truss and frame problems, Isoperimetric formulation. Plane strain, plane stress and axis-symmetric problems, 3D elasticity problems, one and two dimensional heat transfer. Formulation of dynamics problems. Laboratory work on solid mechanics and heat transfer problems.

APL321 Introduction to Computational Fluid Dynamics

4 Credits (3-0-2)

*Pre-requisite(s): APL106 or equivalent, MTL107**Overlaps with: APL720, CLL768, MCL813*

Review of governing equations for fluid flow, finite difference and finite volume method and its application to steady 1-D, 2-D and 3-D convection-diffusion problems, extension of FVM to unsteady 1-D, 2-D and 3-D convection diffusion problems, solution of discretized Navier Stokes equations and boundary conditions, physical description of turbulence, Reynolds-Averaged Navier-Stokes equations, closure problem; RANS based turbulence models; introduction to DNS and LES.

APL331 Advanced Mechanics of Solids

3 Credits (3-0-0)

Pre-requisite(s): APL104/APL105/APL108 EC50

Mathematical Preliminaries (scalar, vector, tensor operation) Thermodynamics thermodynamically framework for constitutive modeling), Kinematics of Deformation & Motion, Stress-strain principles, Elasticity, Anisotropy, viscoelasticity, multi-physical coupling effect, plasticity, viscoelasticity. Experimental: Experimental characterization, data analysis, Model fitting.

APL340 Chaos

4 Credits (3-1-0)

Pre-requisite(s): APL100 and EC 50

Introduction to linear systems and its classification, Fixed point and stability, linear stability analysis, Linearization of nonlinear systems, Types of bifurcation and examples, imperfect bifurcations and catastrophes, Coupled oscillators and quasiperiodicity, Poincare Maps, Introduction to Chaos, Lorenz equation, one-dimensional map, fractals.

APL360 Engineering Fluid Flow

4 Credits (3-0-2)

Pre-requisite(s): APL100 and EC 50

Introduction to Cartesian tensors.

The Navier Stokes Equations: Derivation via continuum mechanics; Boundary conditions; surface tension; Exact Solutions; Steady and unsteady problems; Similarity solutions.

Laminar Boundary-Layers: Order of magnitude analysis; Blasius solution; Von Kármán Momentum Integral; Free-shear flows.

Low Reynolds Number flows: Stokes Flow; Oseen's Correction. Lubrication Approximation.

Hydrodynamic Stability Theory: Capillary Instability; Orr-Sommerfeld Equation; Rayleigh Equation. Inflection Point Criterion. Rotating flows.

Introduction to Turbulent Flows: Reynolds decomposition; Closure problem. Scaling arguments; energy cascade and vorticity dynamics.

APL361 Advanced Fluid Dynamics

3 Credits (3-0-0)

*Pre-requisite(s): APL106 or equivalent**Overlaps with: APL360, APL711, APL715, MCL702*

Derivation of Navier-Stokes (NS) equations; Boundary-conditions and Exact/Similarity solutions. General Boundary-Layer assumption; Free-shear flows; Separation and drag crisis. Low Reynolds Number flows: Stokes Flow; Oseen's Correction; Lubrication Theory. Hydrodynamic Stability Theory: Capillary Instability; Orr-Sommerfeld Equation; Squire's Theorem; Turbulence: Nature of turbulence; Averaging and scales; Reynolds decomposition and the closure problem; Kolmogorov hypotheses and microscales; Reynolds stress; eddy viscosity vs. molecular viscosity. Dynamics of turbulence; balance of kinetic energy, vorticity dynamics, scalar dispersion. Statistics; convergence of averages; correlations and probability density functions. Turbulent shear flows.

APL380 Biomechanics

3 Credits (3-0-0)

Pre-requisite(s): APL100 and EC 50

Basics of rigid body mechanics, solid mechanics, and fluid mechanics applied in biological system; Basic introduction to anatomy and physiology; Mechanics of Human Motion; Mechanics of response of tissues including bones; Mechanics of Blood flow, Biosolid-fluid interaction.

Computer Lab contents: Matlab Programming basics, Image processing basics, Design of Joint: Rigid Body Mechanics based approach, Matlab programming for bone or Aortic Tissue; Matlab programming for blood flow analysis.

APL390 Experimental Techniques in Fluids and Solids

3.5 Credits (2-0-3)

Pre-requisite(s): APL103

Review of errors in measurements and other statistical concepts related to errors and their combinations, and probability distributions. Advanced techniques in fluid flow: Hot wire Anemometry, Laser Doppler Velocimetry and particle sizing, particle Image Velocimetry, Volumetric methods: Tomo PIV and background oriented Schlieren, Derived Quantities from PIV: Vorticity, strain rate and pressure. Applications related to Strain gauges, Clip gauges, Piezoelectric sensors, and Ultrasonic sensors. Coherent gradient sensing (CGS). 2D Digital image correlation (DIC) for full field measurements. Moire fringe methods. Particle image velocimetry (PIV). Hardness testing of the common engineering materials. Characterization of solids under compression, tension and shear. Fatigue and Creep testing. Drop tower. Modal analysis and structural vibrations. Sound absorption characterization of the material.

APL402 Fluid Structure Interaction

3 Credits (3-0-0)

Pre-requisite(s): APL104 or equivalent, APL106 or equivalent

Introduction, Flow separation, Vortex shedding, Basics of vibration, Spring-mass system, Free and forced vibration, Dimensional analysis, Coupled equations of fluid and structure, Dimensionless coupled equation, Dimensionless numbers in FSI, Added mass. Vortex induced vibrations, Wake oscillator model, Galloping, Vibration induced in pipes by external and internal axial flow, sloshing, Dynamics of continuous solid and fluid systems, Waves and vibrations in FSI, basics of acoustics. Computational techniques for FSI solvers: Monolithic vs partitioned approach, One-way/explicit vs two-way/implicit coupling, accuracy, and stability criterion.

APL405 Machine Learning in Mechanics

3 Credits(2-0-2)

Overlaps with: ELL784, COL341, COL774

Introduction: Linear Algebra, Probability review, Programming Basics, Challenges in Data Handling Regression: Simple Linear Regression, Multiple Linear Regression, Nonlinear Regression, Logistic regression Introduction to Machine learning: Supervised Learning, Unsupervised Learning, Classification and Clustering Algorithms Applications of Machine Learning in Mechanics: Case Studies include Identifying faulty/healthy wind turbines, Turbulent Flow Analysis, Leakage Detection in Hydraulic Circuits, Fault Detection in Motor-Bearings, Human Activity Recognition, Heart Sound Classification etc. Deep learning: Introduction to Neural Networks, Convolution and Artificial Neural Networks, Applications in Engineering Mechanics Practical's: MATLAB tools including Curve Fitting Toolbox, Classification Learner App, Deep Network Designer App, Tensor Flow, Training models on GPUs.

APL410 Multiscale Modeling and Computation

3 Credits (3-0-0)

Pre-requisite(s): APL104 or equivalent course in Basic Solid Mechanics

Introduction to multiscale modeling; Bridging nano, micro and

macro scale in materials; Basic equations of continuum mechanics; Micromechanical homogenization theory: Ergodicity principle, representative volume element, periodic boundary conditions, eigenstrain, eigenstress, inclusions; Effective elastic modulus: self-consistent method, Mori-Tanaka method, Eshelby method, Multi-inclusions problems; Voigt and Reuss bound; Hashin-Shtrikman variational principles; Micromechanical damage theory; Micromechanics of phase transformation in solids; Nanomechanics: Linear atomic chains, two and three dimensional lattices, Molecular mechanics, Cauchy-Born rule.

APL411 Application of Finite Elements (Project Oriented)

3 Credits (2-0-2)

Introduction to FEM, Types of elements, degrees of freedom, loads and boundary conditions. Introduction to finite element software, Mesh refinement, convergence criterion, Stress analysis in a three-dimensional body, Application to frames, beam and plate elements, Transient dynamic analysis, Stability of lightweight structures, Fracture analysis, Application to smart structures.

APL412 Computational to Multibody Dynamics

3 Credits (3-0-0)

Pre-requisite(s): APL203

Overlaps with: MCL738

Kinematics, Angular velocity, Frame, Composition of velocities, Euler Newton formulation of equations of motion. Energy based formulation of Equations of motion (Hamiltonian and Lagrangian). Constraints equations (2D & 3D) and Actuators System level multibody equation formulation for 2D examples. Numerical integration of the E.O.M. of the system (2D). Orientation parameterization: Euler angles, Euler parameters, Quaternions etc. Examples of 3D rigid multibody systems. Intro to flexible-multibody systems (governing equations etc).

APL415 Composite Mechanics and Structures

3 Credits (3-0-0)

Pre-requisite(s): APL311, APL331

Overlaps with: APL835

Composites, Various reinforcement and matrix materials, Strength and stiffness properties, Effective moduli, Spherical inclusions, Bio-composites, cylindrical and lamellar systems, Laminates: Laminated plates, Analysis and Design with composites, Fiber reinforced pressure vessels, dynamic, inelastic and non-linear effects, Fabrication of composites, Machining of composites, Strength evaluation, Technological applications.

APL421 Applications of CFD

3 Credits (2-0-2)

Pre-requisites: APL 720

Review of basics of the Finite Volume Method (FVM): discretization schemes, time stepping, stability, types of grid, iterative solution methods. Structured and unstructured grid generation. Projects on simulations of steady laminar flow (lid driven cavity and boundary layer flow), unsteady laminar flow (flow past a cylinder), turbulent flows (using Reynolds-averaged Navier-Stokes equations, channel flow and pipe flow), large eddy simulation, direct numerical simulations and extraction of various statistics from raw CFD data.

APL422 Advanced Computational Fluid Mechanics

3 Credits (2-0-2)

Pre-requisite(s): APL106 or equivalent, APL321

Overlaps with: APL720, CLL768, MCL813

Introduction to numerical methods, mesh generation and mesh adaptivity, spectral methods and applications to fluid simulations, discrete and fast Fourier transforms, Chebyshev polynomials, Gibbs phenomena, spectral discretization methods for diffusion and convection-diffusion problems, staggered and collocated grids, pressure velocity coupling, predictor corrector method multigrid method.

APL424 Introduction to Hydrodynamic Stability

3 Credits (3-0-0)

Introduction, Mechanisms of instability, Kelvin-Helmholtz Instability, Inviscid Instability of Parallel Flows, Viscous Instability of Parallel Flows, Free Surface Flows, Orr-Sommerfeld equation, Tollmien-Schlichting waves.

APL431 Aircraft Structures

3 Credits (3-0-0)

Pre-requisite(s): APL100, APL104

Introduction to elasticity and aerospace structures Loads on aerospace structures, Beams, Truss and Frame Torsion of noncircular prismatic bars. Curved beams. Stability of structures. Theory of Thin-walled beams, Open and closed cross-section, Torsion and bending of thin-walled beams. Normal stresses and shear flows, shear Centre, bending and torsional stability. Energy and variational based numerical methods.

APL432 Aeroelasticity

3 Credits (3-0-0)

Pre-requisite(s): APL104, APL106

Introduction to aeroelasticity and aeroelastic phenomena, Static and dynamic aeroelastic phenomena using simplified aerodynamic and structural models, 1-Daeroelastic model of airfoil, Divergence of 2-D airfoil and straight wing, Wing loading and deformations, Flutter model of 2-D airfoil, Unsteady aerodynamics, 2-D and 3-D supersonic flow, Subsonic flow, Theodorsen theory, Flutter calculation, Exact treatment of bending – torsion, Flutter of uniform wing, Flutter analysis by assumed mode method, Panel flutter, Numerical aeroelastic calculations using software.

APL433 Introduction to Plates and Shells

3 Credits (3-0-0)

Pre-requisite(s): APL104

Overlaps with: APL831, CVL858

Basic assumptions of two-dimensional (surface) theories Theory of thin plates, bending of rectangular and circular plates, shear deformation theories. General theory of curved shells, Axi-symmetric problems of cylindrical, conical and spherical shells and pressure vessels, membrane problems of cylindrical, spherical and conical shells. Energy methods, Design considerations.

APL434 Smart Materials and Structures

3 Credits (3-0-0)

Pre-requisite(s): APL104

Overlaps with: CVL864

Introduction to Smart Material Systems; Overview of smart materials, Modeling mechanical, thermal and electrical systems (thermo mechanics and electrostatics); Piezoelectric materials: constitutive modelling, piezoelectric beam static and vibration analysis Shape memory alloys (SMA): constitutive modelling, actuation models for SMA, electrical actuation Brief overview of Electroactive Polymers, Magnetostrictive materials, Electro and Magneto Rheological Fluids Mechanics of smart composite structures Transducer applications: Vibration control and damping using piezoelectric materials. Case study: Sensing and control of Smart beams and plates.

APL435 Impact Mechanics and Crash Worthiness

3 Credits (3-0-0)

Pre-requisite(s): APL311, APL331

Rigid body impact, Stress waves in solids, Applications of one dimensional stress wave theory. Reflection at boundaries and interface, Waves in infinite and semi-infinite medium, Plasticity and Plastic Waves, Shock waves and Equation of State, Material Characterization and Impact Tests, Computational Methods for Impact, Applications to Ballistic Impact and Vehicle Collision.

APL440 Parallel Processing in Computational Mechanics

4 Credits (3-0-2)

Pre-requisite(s): APL310

Introduction to multi-processor, multi-core, multi-threaded processing and their clusters, GPUs and CUDA programming, Introduction to parallel processing hardware and software, Open MP, MPI, MPICH, HPC/Clustering tools and software suits.

Exploring parallelism in solid/fluid mechanics problems and formulation of numerical methods, Partitioning and divide-and-conquer strategies, Parallel algorithms for solving dynamical and non-linear systems, Finite difference and Finite element analysis of plate and shells, Finite elements in fluids, Reduced integration patch test, Dynamic FE analysis, Geometrically nonlinear problems, Material nonlinearity, Automated mesh generation, Pre and post processing, Solid fluid interaction problems, Efficient solution technique-PCG, Domain decomposition, Point source method, Boundary element method, Aero elastic flutter, Other special topics.

APL450 Introduction to Soft Robotics

3 Credits (3-0-0)

Pre-requisite(s): APL104 or equivalent

Soft robots vs Rigid robots, manufacturing techniques of multifunctional soft robot devices: Modeling soft mechanics (numerical, computational, analytical), Introduction to morphological simulation: Soft actuators (Dielectric, pneumatic, fluidics): Soft sensors (Fluidic, solid, composites, textiles): Soft logic (controllers, semiconducting polymer, thin film silicon): Soft energy (thermodynamics, soft batteries, soft combustion) Applications (wearable robotics, space robotics, deep-sea robotics).

APL452 Introduction to Digital Twins

3 Credits (2-0-2)

Pre-requisite(s): MTL107, APL203, COL100

Introduction to Digital Twins and establishing the need for Computational Tools in modern engineering. First Principles Modelling using numerical solutions of ODEs and PDEs, Simulation of Dynamic systems in the Time-domain using Block-domain methods & Physical Modelling using Lagrangian Methods. Data-driven Modelling: Data Handling, Filtering and pre-processing, Visualization and Classification, Fitting classification models to data. Case Study or Project.

APL491 Reliability Engineering

3 Credits (3-0-0)

Uncertainties in Engineering Systems, Bathtub analogy, RAM Concept, Limit State/Performance function, Random variables, Probability concepts and statistical models, Joint probability distribution, Application of Boolean Algebra, Bayesian Theory, Logic gates, Baye's theorem, System reliability, Series and parallel system, System with standby units, Reliability assessment methods, Deterministic and probabilistic approaches, Codal provisions, Probabilistic design methodology, Stochastic finite element method, Applications, Case studies in project mode.

AML701 Engineering Mathematics & Mechanics

3 Credits (3-0-0)

Partial differential equations. Fourier Series and transforms. Calculus of variations. Newtonian and Lagrangian mechanics. Variational and Hamiltonian mechanics.

APL701 Continuum Mechanics

3 Credits (3-0-0)

Concept of continuum, kinematics of deformation, concept of stress and strain tensor – their transformation and decomposition, finite strain tensor and its linearization with examples, rate of deformation tensor – velocity gradient and spin tensor, derivation of conservation laws – mass continuity, linear and angular momentum conservation, derivation of linear equations of elasticity and Navier Stokes equations

in both cartesian and polar co-ordinates, principle of minimum potential energy, virtual work theorem, uniqueness and reciprocal theorem, constitutive laws for linearly elastic solids and newtonian viscous fluids, incompressible case, applications in solid and fluid mechanics problems.

AML702 Applied Computational Methods

4 Credits (3-0-2)

Algorithms. Methods of undetermined coefficients. Numerical differentiation and integration. Solution of ordinary differential equations. Solution of linear and non-linear algebraic equations. Boundary value problems and initial value problems. Numerical solution of partial differential equations. Eigenvalue problems.

APL702 Experimental Methods for Solids and Fluids

3 Credits (2-0-2)

Types of Measurement and errors, Internal and external estimates of errors, Relative frequency distribution, Histogram, True Value, Precision of measurement, Best estimate of true value and standard deviation, Combination of measurements, accuracy of the mean, significant digits. Methods of least squares and its application to the calculation of best estimate of the true value, the curve fitting, general linear regression, comparison and combination of measurements. Extensions of least square method, Principle of maximum likelihood, and goodness of fit, chi-square test, Dynamic response of a measuring instrument, Response to transient and periodic signals, first and second order systems as well as their dynamics response characteristics.

APL703 Engineering Mathematics and Computation

4 Credits (3-0-2)

Tensors, Vector Calculus; Linear Algebra – Solution of Linear Systems, Eigenvalue Problems; Variational calculus; Fourier Series and transform, Analytical and Numerical Solution methods of ODEs, Partial Differential Equations – properties and solution techniques, Probability and Statistics.

AML704 Flow of Non-Newtonian Fluids and Complex Mixture

3 Credits (3-0-0)

Classification and properties of non-Newtonian Fluids, Rheological parameters and flow properties. Governing equations. Flow of non-Newtonian fluids through pipes. Turbulent Flows. Complex mixtures. Phase separation and setting behavior. Fundamental concepts for flow of mixtures. Flow of mixtures through pipes. Typical flow patterns.

APL705 Finite Element Method

4 Credits (3-0-2)

Pre-requisite(s): EC 75

Strong and weak forms of governing differential equations, and their equivalence, Weighted residual and variational approaches. Ritz method. Discretization of weak form and boundary conditions. Convergence. Bar and beam elements. Truss and frame problems, Isoparametric formulation. Plane strain, plane stress and axisymmetric problems, 3D elasticity problems, one and two dimensional heat transfer. Formulation of dynamics problems. Laboratory work on solid mechanics and heat transfer problems.

AML706 Finite Element Methods and its Applications to Marine Structures

3 Credits (3-0-0)

Introduction to FEM. Variational methods. Element types and properties. Boundary conditions. Stress-strain determination. Solution techniques. Mesh refinement. Convergence criterion. Frames, beams and axial element. Plane stress. Plane strain. Axisymmetric problems. Plate bending. Fluid mechanics and heat transfer. Super elements. Structural instability of frames and beams.

APL707 Integral Equations

3 Credits (3-0-0)

Overlaps with: MTL746

Hadamard's inequality, Hilbert spaces, existence theorems, Volterra equations, Fredholm equations, application to partial differential equations, integral transforms – Fourier, Laplace, Hankel & Mellin, Wiener-Hopf method/equations, singular integral equations of the Cauchy type, numerical techniques for singular integral equations, application to elasticity problems.

APL710 Computer Aided Design

4 Credits (3-0-2)

Pre-requisite(s): EC 75

Principles of computer aided design, Computer graphics fundamentals, 2D and 3D Transformations and projections, Plane Curves, Space Curves, Synthetic curves. Analytical and parametric surfaces, Synthetic surfaces, Solid Modeling basics, Solid modeling techniques and schemes, Half-spaces, Boundary Representation (B-rep), Constructive Solid Geometry (CSG), Sweep Modeling, Analytical Solid Modeling, Visual Realism, hidden lines and surface.

APV710 Similitude and Approximations in Engineering

1 Credits (1-0-0)

Pre-requisite(s): EC 75

Introduction to the concept of natural units; dimensional analysis; method of scale factors; non-dimensionalization of governing equations and boundary conditions; self-similarity; relaxation of modelling requirements; introduction to the theory of approximations; singular approximations and boundary layers; case studies from diverse fields.

APL711 Advanced Fluid Mechanics

3 Credits (3-0-0)

Mathematical Preliminaries, Kinematics, Navier Stokes equations and some standard solutions, Low Reynolds number flows and Lubrication, Vorticity dynamics, Introduction to boundary layers, Hydrodynamic stability, 1-D compressible flows.

AML713 Applied Fluid Mechanics

4 Credits (3-1-0)

Basic equations of fluid motion, Dynamics of ideal fluid motion, Generalised Bernoulli equation and special cases, Governing equations for viscous fluid flows, creeping fluid flows, Boundary layer approximation, Transition to turbulence, Fundamentals of turbulent flow, turbulent boundary layer over a flat plate.

APL713 Turbulence and its Modeling

3 Credits (3-0-0)

Nature of turbulence, Governing equations, Fourier, Lagrangian and Eulerian description of turbulence, Statistical description of turbulence, Kolmogorov's hypotheses, turbulence processes, turbulence closure modelling.

AML714 Fluid Flow Analysis and Application to power plants

3 Credits (3-0-0)

Introduction to flow types, fluid statics, relative equilibrium and Kinematics. Fluid flow equations for mass, momentum, angular momentum, energy and their applications. Inviscid flows. Flow through pipes and Reynolds number effects. Navier-stokes equations and applications. Models of turbulence. Boundary layer flows. Thermal boundary layers. Boundary layers in power plant flows. Thermal boundary layers. Boundary layers in power plant flows (case study). Pipe networks. Turbulent flows in power plant flows (case study). Plane and axi-symmetric jets and wakes and their application in power plants (case study). Compressible flows and applications in power plants (case study). Transportation of material by fluid flows.

Types of complex mixtures. Two Phase flows. Phase separation and settling behavior. Slurry pipeline transformation and applications in power plants (case study). Review of numerical methods in fluid flows. Basic principles of experimental analysis. Flow visualization techniques. Flow metering and other fluid devices for measurement of pressure, velocity, discharge, etc. and their applications in power plants (case study).

AML715 Viscous Fluid Flow

3 Credits (3-0-0)

Governing equations in differential form. Navier-Stokes equations and applications. Review of boundary layer prediction methods. Transition and turbulence. Turbulent boundary layers. Drag on bodies. Free turbulent flows. Turbulent boundary layer prediction methods.

APL715 Physics of Turbulent Flows

3 Credits (3-0-0)

Introduction, nature of turbulence, methods of analysis, scales of turbulent flows. Reynolds decomposition and the closure problem, estimates of the Reynolds stress, comparison with the kinetic theory of gases. Dynamics of turbulence, balance of kinetic energy, vorticity dynamics, scalar fluctuations. Free shear flows: jets, wakes and mixing layers. Wall bounded flows: channel and pipe flows, boundary layers. Kolmogorov hypotheses; probability density function, characteristic function and moments; structure and correlation functions; energy spectra, intermittency. Turbulent transport and dissipation.

APL716 Fluid Transportation Systems

3 Credits (3-0-0)

Mechanism of transportation of materials by fluid flow, rheology and classification of complex mixtures, fundamentals of two-phase flow, Phase separation and settling behavior, Slurry Pipeline Transportation, Design methods, terminal facilities, pipe protection, pneumatic conveying, pneumocapsule and hydrocapsule pipelines, metrology associated with pipelines.

APL720 Computational Fluid Dynamics

4 Credits (3-0-2)

Pre-requisite(s): EC 75

Review of governing equations for fluid flow, finite volume method and its application to steady 1-D, 2-D and 3-D convection-diffusion problems, extension of FVM to unsteady 1-D, 2-D and 3-D convection diffusion problems, pressure-velocity coupling, staggered and colocated grids, solution of discretized equations, physical description of turbulence, Reynolds-Averaged Navier-Stokes equations, closure problem; RANS based turbulence models; DNS and LES.

AML731 Applied Elasticity

4 Credits (3-1-0)

Cartesian tensors, axioms, motion, stress, equations of motion, Poil, Kirchoff stress, finite strain measures, strain energy, small strains, linear elastic constitutive equations. Basic problems. General theorems of uniqueness. Superposition and reciprocity. St. Venant's problem. Plane problems. Principle of virtual work. Potential energy. Complementary energy. Reissner's variational principles. Approximate analytical and numerical methods of solution.

AML732 Solid Mechanics

3 Credits (3-0-0)

Elementary theory of elasticity and plasticity. Theory of plates. Instability of rectangular plates. Stiffened plates. Anisotropic plates.

AML733 Dynamics

3 Credits (3-0-0)

Single degree freedom system. Multidegree freedom system. Numerical methods. Holzer-type problem geared and branched systems. Euler's equation for beams. Torsional vibrations. Continuous systems. Lagrange's equations. Balancing of shaft. Self excited vibration.

APL734 Advanced Dynamics

3 Credits (3-0-0)

Single Degrees of Freedom systems, Multi-degree of freedom systems, Response spectrum, Time integration schemes, Lagrange's equations, Principle of virtual work, continuous system.

APL736 Multiscale Modeling of Crystalline Materials

4 Credits (3-0-2)

Pre-requisite(s): EC 75

Review of continuum mechanics, material symmetry, thermodynamics and constitutive relations, symmetry in crystals, empirical and semi-empirical models of inter-atomic potential, molecular statics and dynamics, finite temperature effects in molecular systems, probabilistic behavior of material characteristics at macro scale, multiscale methods - Cauchy-Born rule and Quasi-continuum method, Mechanics of helical nanostructures (e.g., carbon nanotubes, DNA, polymers), Bending and twisting of nanotubes and nanorods.

Computer Lab contents: Programming molecular statics and molecular dynamics, molecular statics via conjugate gradient minimization and Newton-Raphson method, Monte Carlo simulation, Implementation of Cauchy-Born rule and Quasi-continuum method, Exposure to LAMMPS and AMBER.

APL737 Advanced Design of Machine Elements

3 Credits (3-0-0)

Overview of static failure theories in terms of failure surface. Fracture Mechanics (stress intensity as a design criterion). Fatigue Failure (emulative damage. Strain-life method). Contact mechanic (rough surface contacts, thermo-elastic contact). Surface Failure (hydrodynamic lubrication. Wear mechanics). Creep (Three/Five-Power Law. Life estimation. Statistical Failure (ANOVA reliability theory).

APL740 Mechanics of Biological Cells

4 Credits (3-0-2)

Pre-requisite(s): EC 75

Theoretical Part: Basic Introduction to mechano-biology, Concept of Length Scale, Mechanical Forces, Mass, Stiffness and Damping of Proteins, Thermal Forces and Diffusion, Chemical Forces, Polymer Mechanics. Intracellular Mechanics: Structures of Cytoskeleton Filaments, Dynamics of Cell Filaments, Molecular motors, Introduction to Entropic Elasticity and Persistence Length, Force Generation by Cytoskeleton Filaments. Extracellular Mechanics: The Extracellular matrix (ECM), cell-ECM Interactions, Cell Migration, Forces and Adhesion. Tissue Mechanics: Cell-cell Assemblies, Tissue Material Behavior, Introduction to Linear Viscoelasticity, Concept of Constitutive Modeling. Experimental Part: Different Experimental Methods for Probing Cell Mechanical Properties. Intro to indentation, aspiration, tweezer, Nano patterned platform based techniques etc.

APL 742 Advanced Biomechanics

4 Credits (3-0-2)

Basic Introduction to biomechanics of tissue/cells, Concept of Length Scale, Mechanical Forces, Mass, Stiffness and Damping of Proteins, Thermal Forces and Diffusion, Chemical Forces, Polymer Mechanics. Tissue Mechanics: Cell-cell Assemblies, Tissue Material Behavior, Introduction to Linear Viscoelasticity, Concept of Constitutive Modeling, Nonlinear continuum frame work of biomechanical simulation, special topic on tissue-device interaction, orthopedic/spinal implants etc. Intracellular Mechanics: Structures of Cytoskeleton Filaments, Dynamics of Cell Filaments, Molecular motors, Introduction to Entropic Elasticity and Persistence Length, Force Generation by Cytoskeleton Filaments. Extracellular Mechanics: The Extracellular matrix (ECM), cell-ECM Interactions, Cell Migration, Forces and Adhesion. Experimental Part Different Experimental Methods for Probing Cell & Tissue Mechanical Properties. Intro to Indentation, Aspiration, tweezer, Nanopatterned platform based techniques etc.

APL745 Deep Learning for Mechanics

4 Credits (3-0-2)

Plied math and machine learning basics, deep feedforward network, regularization for deep learning, optimization for training deep learning, convolutional network, recurrent neural network.

Physics informed deep learning in computational mechanics, residual based approach, energy approach, time-discretization in physics informed deep learning, deep learning for inverse problems in mechanics, physics informed deep learning for stochastic dynamic/mechanics problems.

Application in mechanics (Practical Component): Data-driven deep learning for stochastic mechanics. Data-driven deep learning for solving inverse problems, Physics informed deep learning for fracture mechanics, Physics informed deep learning for reliability analysis, Physics informed deep learning for ID phase-field equation, learning parameters of Navier stokes equation and constitutive relations using physics informed deep learning.

AML751 Materials for Marine Vehicles

3 Credits (3-0-0)

Corrosion, Selection of materials, Brittle fracture techniques, Introduction of fracture mechanics, Fatigue, Non-destructive testing.

APL753 Properties and Selection of Engineering Materials

3 Credits (3-0-0)

Pre-requisite(s): EC 75

Historical evolution of engineering materials, evolution of materials in products, Engineering materials and their properties: families of engineering materials, materials information for design, materials properties, Materials property chart: exploring materials properties, materials property charts e.g. the modulus-density chart, the strength-density chart, the fracture toughness-modulus chart, thermal conductivity-electrical resistivity chart, Materials selection-the basics: the selection strategy, materials indices, the selection procedure, Multiple constraints and conflicting objectives: selection with multiple constraints, conflicting objectives, Selection of materials and shape: shape factors, limits to shape efficiency, exploring the materials shape combinations, materials indices that include shape, architected materials, Processes and process selection: classification of processes: shaping, joining and finishing, processing for properties, process selection, ranking process cost, Designing hybrid materials: holes in materials property space, composites, sandwich structures, cellular structures, segmented structures, case studies.

APL764 Biomaterials

3 Credits (3-0-0)

Pre-requisite(s): EC 75

Introduction and history of biomaterials; Basic classes of engineering materials and structure property correlation; Structure and property of cells and tissues; Property requirement of biomaterials including biocompatibility, and biobegability; Basic types of biomaterials; Mechanical testing of biomaterials; application of biomaterials (orthopedic, cardiovascular, dental) including detailed case study, Materials for biomedical devices and packaging (electronic interfacing etc.)

APL765 Fracture Mechanics

3 Credits (3-0-0)

Pre-requisite(s): EC 75

Fracture: an overview, theoretical cohesive strength, defect population in solids, stress concentration factor, notch strengthening, elements of fracture mechanics, Griffiths crack theory, stress analysis of crack, energy and stress field approaches, plane strain and plane stress fracture toughness testing, crack opening displacement, elastic-plastic analysis, J-integral, ductile-brittle transition, impact energy fracture toughness correlation, microstructural aspects of fracture toughness, environmental assisted cracking, cyclic stress and strain fatigue, fatigue crack propagation, analysis of engineering failures.

APL767 Engineering Failure Analysis and Prevention

3 Credits (3-0-0)

Pre-requisite(s): EC 75

Common causes of failure, principles of failure analysis, fracture mechanics approach to failure problems, techniques of failure analysis, service failure mechanisms, ductile and brittle fracture, fatigue failure, wear failure, hydrogen induced failure, environment induced failures, high temperature failure, faulty heat treatment and design failures, processing failure (forging, casting, machining etc.), failure problems in joints and weldments, case studies for failure analysis of structural components and mechanical system.

APL771 Design Optimization and Decision Theory

3 Credits (3-0-0)

Introduction, classification of optimization problems, single variable and multi variable unconstrained optimization problems, constrained optimization, integer programming, genetic algorithms and simulated annealing, review of probability theory, decision theory.

APL774 Modeling & Analysis of Mechanical Systems

3 Credits (3-0-0)

Introduction, constitutive modeling of elastic orthotropic, elasto-plastic isotropic, and viscoelastic isotropic solids. Plane stress problems in polar coordinate system, bending of rectangular plates—Navier and Levy's solution, bending of circular plates, membrane theory of shells, bending of cylindrical shells, vibration and buckling of rectangular plates. Flow measurement, velocity measurement, multi-hole probes and optical measurements. External flows, boundary layers (laminar and turbulent); estimation of lift and drag, internal flows, application to pipe lines.

APL775 Design Methods

3 Credits (3-0-0)

Introduction, design cycle, need analysis, product specifications, quality function deployment (QFD), concept generation, concept selection, TRIZ, concept testing, preliminary design, architecture design. Modeling, sensitivity, compatibility, stability analyses. Design for manufacturing, material, maintenance and safety. Industrial design, detailed design, prototype/model testing. Axiomatic design. Detailed Drawings/Assembly Drawings/Assembly Instructions/Maintenance Manuals, Case Studies.

APL776 Product Design and Feasibility Study (Stream Core)

4 Credits (2-0-4)

Prefeasibility Study, Market Analysis-Development of Sales Plan. Technical Analysis- Development of Manufacturing Plan. Financial Analysis-Develop General and Administrative Plan, Evaluate Project Feasibility, Preparation of project Proposal. Human Factors in Design, Human factors and systems, Information input, Human output and control, Workplace Design, environmental conditions, human factors applications.

AMP777 Product Design Project-II

2 Credits (0-0-4)

The above two course would be run in successive semesters. The combined project work would comprise the following: Application of systematic design procedure for the design of a chosen industrial product. Students are expected to carry out all the three phases of the design cycle including fabrication and testing. Lectures will deal with ergonomical factors in product design.

AML791 Ship Resistance & Propulsion

3 Credits (3-0-0)

Similarity consideration and Model testing, wave making resistance, Viscous resistance, Estimation of Ship resistance, Appendage resistance, Presentation of resistance data and use of methodical series, resistance of high speed and advanced marine vehicles. Hull propeller interaction, Cavitation, Wave-wake interference, thrust

computations, Scale effect, propeller design, Various propulsion devices, Ship standardization trials.

AML792 Structural Design of Ships

3 Credits (3-0-0)

Introduction, Ship as beam, long term loading of ship structure, periodic wave loading, longitudinal response & dynamic behaviour, Criteria of failure, Analysis of plates and grillages, Buckling of plates and panels, Recent advances in load definition, transverse strength, torsional strength, bulkhead design, design of special structures, structural design of unconventional crafts like hydrofoils, hovercrafts, SES, SWATH, Catamarans, trimarans etc., design of submarine structures, pressure hull, design of cylindrical shells, cones, bulkheads etc., Applications of computers to ship structures and structural optimization.

AML793 Ship Dynamics

3 Credits (3-0-0)

Dynamics of oceans. Wave characteristics. Probabilistic theory of waves. Ship motions. Sea loads and bending moments. Limiting criteria stability and control of ships. Stabilization systems. Tests and trials.

AML794 Warship Design

3 Credits (3-0-0)

Salient features of warships, merchantships, naval auxiliaries and yard-craft Principles and morphology of engineering design. Design spiral Feasibility studies. Preliminary design. Detailed design Warship design and production procedures. Staff requirements. Design activities. Drawing and specifications. Ship production Tests and trials. General arrangement drawings—Weapon layout. Mass and space analysis. Stability aspects, Resistance, propulsion. Seakeeping and manoeuvring considerations in design. Structural considerations. Survivability Cost aspects. Special types of hull forms. Computer aided ship design.

AML795 Submarine Design

3 Credits (3-0-0)

Flotation and trim. Hydrostatics. Survivability. Surface unsinkability. Stability. Design of pressure proof structures. Design of school mounts of equipments. Resistance. Methods of drag reduction. Selection propulsion system. Endurance and indiscretion rates. Sea motions. Manoeuvrability in vertical and horizontal planes and control surface design. Habitability. Ergonomics. Stealth systems. Submarine design procedures. System approach of submarine design and military economic analysis. Use of computers in submarine design. Outer hull lines development. Simulation of submarine in vertical plane.

APL796 Advanced Solid Mechanics

3 Credits (3-0-0)

Large deformation kinematics, lagrangian stress and strain tensors, balance laws in lagrangian framework, nonlinear constitutive modeling, nonlinear theory of beams and buckling, wave propagation, theory of plasticity, solution of elasticity problems – contact modeling, multiscale modeling etc.

AMS801 Independent Study

3 Credits (0-3-0)

AMS802 Independent Study

3 Credits (0-3-0)

APL805 Advanced Finite Element Method

3 Credits (3-0-0)

Pre-requisite(s): APL705

Variational calculus; Weak formulation of governing equations and its linearization; discretization of nonlinear weak form and its solution; convergence requirement of shape functions; systematic generation of higher order elements; mixed FEM/penalty method; non-uniform and

adaptive discretization – p and H convergence; solid-fluid interaction problems; Generalized and extended finite element methods.

APV 808 Planar Contact Mechanics

1 Credits (1-0-0)

AML731 or APL796 or an equivalent course in Linear Elasticity

Plane Contacts: Surface traction, interior stress fields, partial slip rough contacts, numerical techniques.

APD811 Major Project Part-I

6 Credits (0-0-12)

AML811 Advanced Computational Fluid Dynamics

3 Credits (3-0-0)

Transport equation in rotating reference frame, finite volume methods including higher order upwinding, grid generation, Galerkin & upwind finite element methods, considerations in discretization of turbulence models, rotating reference frame, hybrid methods gridless methods, multigrid method, special topics chosen from phase change problem, two-phase flow, compressible flow and numerical simulation.

APD812 Major Project Part-II

12 Credits (0-0-24)

AMD813 Major Project Part-I

6 Credits (0-0-12)

AMD814 Major Project Part-II

12 Credits (0-0-24)

APL815 Hydrodynamic Stability

3 Credits (3-0-0)

Introduction, Kelvin-Helmholtz instability, Rayleigh-Benard Convection, Inviscid instability of Parallel Flows, Viscous Instability of Parallel Flows, Free Surface Flows, Weak-Nonlinear Instability, Absolute and Convective Instability.

AML816 Compressible Fluid Flow and Gas Dynamics

3 Credits (3-0-0)

Review of one-dimensional flows. Two-dimensional flows. Shocks and interactions. Small perturbation theory. Method of characteristics. Stock-boundary layer interaction. Viscous effects. Introduction to flows with chemical reactions. Dynamics of radiating gases. Hypersonic flows.

AML820 Advances in Fluid Engineering

3 Credits (3-0-0)

A course on any advanced topic in the area of Fluid Engineering may be floated under this number.

AML821 Flow Induced Vibrations

3 Credits (3-0-0)

General governing equations for solid-fluid interaction problems. Decoupling approximations. Acoustically applied forces. Steady-state scatter, transient scatter and transient shock response. Hydrodynamically applied forces Flow induced noise, dynamic divergence of compliant surfaces, flutter, stability of boundary layer on compliant surfaces, propeller induced forces. Aeroelastic flutter of plates, linear and non-linear response. Flow induced vibrations of pipes and tube arrays etc.

APL831 Theory of Plates and Shells

3 Credits (3-0-0)

Basic assumptions of two-dimensional theories, Theory of surfaces, Strain-displacement relations in shell coordinates, Stress-resultants,

General governing equations of motion, Boundary conditions. Analytical solutions for bending and vibration of rectangular plates and circular plates. Approximate solution techniques. Membrane theory and its applicability, Membrane and general bending solutions cylindrical, conical and spherical shells, and pressure vessels. Selected problems on the stability. Design considerations.

AML832 Applications of Theory of Plates and Shells

2 Credits (2-0-0)

Introduction. Recapitulation of classical plate theory. Orthotropic plate bending. Simplified 4th order theory. Panels and grillages. Navier's and Levy's solutions. Stability. Bending of circular cylindrical shells. Stability of semi-infinite and finite cylinders. Donnell equations. Shells of revolution. Applications.

AML833 Applied Plasticity

3 Credits (3-0-0)

Fundamentals of plasticity theory. Solution of elastoplastic problems. Theory and application of slip-line field. Bound theorems. Plastic anisotropy. Large deformations. Dynamic plasticity.

AML834 Structural Stability

3 Credits (3-0-0)

Types of instability, static, dynamic and energy criterion of buckling. Imperfection sensitive structures. Applications to columns, beams, plates and shells. Follower forces, non-conservative loads.

APL835 Mechanics of Composite Materials

3 Credits (3-0-0)

Composites, Various reinforcement and matrix materials, Strength and stiffness properties, Effective moduli, Spherical inclusions, Bio-composites, cylindrical and lamellar systems, Laminates: Laminated plates, Analysis and Design with composites, Fiber reinforced pressure vessels, dynamic, inelastic and non-linear effects, Fabrication of composites, Machining of composites, Strength evaluation, Technological applications.

AML836 Non-linear Vibration and Chaos

3 Credits (3-0-0)

Pre-requisite: AML701/AML734/CEL719/MEL733

Non-linear system. Analytical and graphical solutions. Solution stability and bifurcation. Fourier transforms. Poincare section. Temporal chaos in dissipative systems. Simple and strange attractors. Fractal dimension and geometric characterization. Hopf bifurcation and limit cycle. Sub-harmonic instability and periodic doubling.

AML837 Structural Mechanics

3 Credits (3-0-0)

Matrix analysis of structures. Displacement methods. Substructuring grillages. Finite element methods for a structural continuum. Element behaviour. Element families. Computational aspects of finite element methods.

AML838 Non-linear Mechanics

3 Credits (3-0-0)

Singular points of non-linear systems. Phase plane and limit cycles. Non-linear conservative systems. Variational techniques for solving autonomous, resonant and non-resonant systems and asymptotic methods. Application to beams, plates and shells.

AML840 Advances in Solid Mechanics

3 Credits (3-0-0)

An advanced course on any specialized topic in the area of Solid Mechanics may be given under this number. The course content will be announced by the teacher.

AML841 Advanced Theory of Elasticity*3 Credits (3-0-0)*

Two-dimensional problems in elasticity using complex variable techniques and conformal mapping. Three-dimensional problems. General representation theorems. Stability theory. Dynamics elasticity. Theory of rods.

APL871 Product Reliability and Maintenance*3 Credits (3-0-0)*

Reliability; basic concepts, Uncertainty in engineering systems; Modeling, Multiple random variables, product failure theories, Failure models, Limit state function, Probability distribution, PDF & CDF, Evaluation of joint probability distribution, Markov Process, Stochastic Finite Element Analysis, Randomness in response variables, First and higher order methods for reliability assessment, Deterministic & probabilistic approach, Risk based design, Maintainability, Central limit theorem, load and resistance approach, Fault tree approach, system reliability, stress strength interference method, Monte-Carlo and other simulation techniques, Regression analysis, Software based reliability analysis, Sensitivity analysis and reliability based design optimization, international standards, Applications & case studies.

AML872 Optimization Techniques*3 Credits (3-0-0)*

Classical optimization techniques for unconstrained optimization. Kuhn-Tucker conditions. Sensitivity analysis for linear programming problems. Non-linear programming. Penalty function methods. Sequential linear programming. Feasible direction methods. Quadratic programming. Geometric programming. Integer programming. Application in engineering design.

AML873 Design for Production*3 Credits (3-0-0)*

Basic concepts and goals of design for production. Processes, machines and tools for the manufacture of parts made from metals, ceramics and polymers. Significance of form in case of manufacture. Attainable tolerances. Industrial finishes like painting, polishing, anodising nickel and chrome painting, surface texturizing. Value analysis. Group technology. Assembly strategies. Design for quality.

APL8M4 Critical Product Evaluation*3 Credits (3-0-0)*

Value analysis. Quality standards in electronic, optical, mechanical and other products. Critically examining product literatures, raising questions, filling gaps in information and discovering hidden details from product literature. Identifying areas of design action by identifying limitations in existing products and gaps in market segment. Examining and existing product for appreciation and detailing.

APD895 MS Research Project*36 Credits (0-0-72)***AMD897 Minor Project***3 Credits (0-0-6)***AMD899 Design Project***10 Credits (0-0-20)*

Department of Biochemical Engineering and Biotechnology

BBL131 Principles of Biochemistry

4.5 Credits (3-0-3)

Introduction-aims and Scope; Non-covalent interactions in biological systems, Carbohydrates-structure and function; Proteins-structure and function; Nucleic acids-structure and function Protein purification techniques; Introduction to enzymes; Vitamins and coenzymes; Lipids and biological membranes; Transport across cell membrane; Design of metabolism; Metabolic pathways for breakdown of carbohydrates-glycolysis, pentose phosphate pathway, citric acid cycle, electron transport chain, Photo-phosphorylation; Oxidation of fatty acids; Gluconeogenesis and control of glycogen metabolism, Signal transduction.

Laboratory: Estimation of proteins and nucleic acids; Extraction of lipids; Separation of lipids using thin layer chromatography, Gel filtration and ion exchange chromatography; Gel electrophoresis, Determination of enzymatic activities and determination of K_m , V_{max} . Identification of intermediates of EMP pathway.

BBL132 General Microbiology

4.5 Credits (3-0-3)

The topics include introduction to prokaryotic and eukaryotic cell structure; different groups of microorganisms; microbial nutrition and growth; metabolism including important pathways; reproduction and recombination; preservation and control of microbial cultures; viruses; microbial pathogenicity.

Laboratory: Preparation and sterilisation of culture media, isolation of bacteria, Staining, Biochemical tests for identification of microorganisms, Antibiotic sensitivity, Bacterial growth curve, effect of environmental factors on bacterial growth, microbial diversity in environmental samples.

BBL133 Mass and Energy Balances in Biochemical Engineering

3 Credits (3-0-0)

Overlaps with: CLL111

Stoichiometric relations and yield concepts, Maintenance coefficient, Mass balance based on available electron concept; Units and dimensions, Fundamentals of material balance, Balance on unit processes and reactive systems, Behaviour of ideal and real gases, vapour pressure, humidity and saturation. Energy balance, Heat capacity of gases, liquid and solids, Latent heat, Heat of reaction, formation and combustion, solution and dilution. Energy balance of reactive and non-reactive processes. Unsteady state material and energy balance in bioprocess. Case studies.

BBL231 Molecular Biology and Genetics

4.5 Credits (3-0-3)

Pre-requisite(s): BBL131, BBL132

Historical development and essentials of Mendelian genetics. Chromosomal theory of inheritance. Evolution and development of molecular biology. DNA model and classes. Organization of eukaryotic chromosome – the chromatin structure. Gene structure and Genome. Transposon. Genetic Information and its perpetuation – DNA replication, damage and repair. Telomere and Aging. Transcription, translation. Molecular biology of bacteriophage lambda. Gene exchange in bacteria. Gene regulation in prokaryotes. The operon model – lac, ara, trp operons and gene regulation. Gene Regulation in Eukaryotes. DNA Methylation and Genomic Imprinting.

Laboratory: Isolation of genomic and plasmid DNA, Agarose Gel Electrophoresis of DNA, Restriction digestion of DNA, RNA isolation, Primer design, PCR, RT-PCR, Competent cell preparation and Transformation, Gene Induction.

BBL331 Bioprocess Engineering

3 Credits (3-0-0)

Pre-requisite(s): BBL132, BBL133

Microbial growth, substrate utilisation, and product formation kinetics; simple structured models; batch, fed-batch, repeated fed-batch,

CSTR, CSTR with recycle, multistage CSTRs, and PFR; aeration and agitation; rheology of fermentation fluids; mixing and scale-up; air sterilization; media sterilization; design of fermentation media; aseptic transfer.

BBP332 Bioprocess Engineering Laboratory

1.5 Credits (0-0-3)

Pre-requisite(s): BBL131, BBL132

Laboratory: Design and execution of simple laboratory scale experiments on the following topics: Estimation of cell mass; different phases of microbial growth; Mass and energy balance in a typical bioconversion process; Concept of limiting nutrient and its effect on cell growth; growth inhibition kinetics; product formation kinetics in a fermentation process; aerobic and anaerobic bioconversion process; power consumption in a fermentation process and its correlation with rheology of the fermentation fluid; different agitator types; mixing time in a bioreactor; quantification of K_La in a fermentation process; Heat balance across a batch sterilization process; Assembly and characterization of pH/DO electrodes.

BBL341 Environmental Biotechnology

3 Credits (3-0-0)

Pre-requisite(s): CVL100 and EC 80

Principles and concepts of ecosystem; Energy transfer in an ecosystem; Nutrient cycling; Basics of Environmental Microbiology, Environmental health: Ecotoxicology – Heavy metals, pesticides and their effects, Indices of toxicity, Measurement of pollution (techniques and instrumentation), Dose–response relationship. Microbial biosensors in environmental monitoring, Environmental technologies: Microorganisms and renewable sources of energy, Biodegradation and bioremediation (phyto and microbial), Energy and nutrient recovery during waste treatment, Risk assessment: Life cycle analysis, Molecular tools in Environmental Biotechnology, Role of biotechnology in environmental protection.

BBL342 Physical and Chemical Properties of Biomolecules

3 Credits (2-1-0)

Pre-requisite(s): BBL131

Characteristic features of Biological system, Structure-function relationships. Characterization of biomolecules by molecular shape, size and molecular weight. Properties of biomolecules in solution: Diffusion, ultra-centrifugation and electrophoresis. Optical properties of biomolecules; Spectroscopic methods: IR, NMR, Optical rotary and circular dichroism & imaging methods: Bright, darkfield and fluorescence imaging.

BBL343 Carbohydrates and Lipids in Biotechnology

3 Credits (2-1-0)

Pre-requisite(s): BBL131 and EC 60

Introduction, Molecular structure of polysaccharides, Enzymes degrading polysaccharides, Physical properties of polysaccharides, Production of microbial Polysaccharides, Food usage of exopolysaccharides, Industrial Usage of exopolysaccharides, Medical applications of exopolysaccharides Molecular structure of lipids, Physical properties of lipids, Oleaginous microorganisms and their principal lipids, Production of microbial lipids, Modification of lipids for commercial applications, Extracellular microbial lipids and biosurfactants, Micelles and reverse micelles in biology, Liposomes in drug delivery.

BBV350 Special Module in Biochemical Engineering and Biotechnology

1 Credit (1-0-0)

BBD351 Mini Project (BB)

3 Credits (0-0-6)

Pre-requisite(s): EC 60

BBL431 Bioprocess Technology

2 Credits (2-0-0)

Pre-requisite(s): EC25

Chemical vs biochemical processing; Substrates for bioconversion processes; Process technology for production of primary and secondary metabolites such as ethanol, lactic acid, citric acid, amino acids, biopolymers, industrial enzymes, penicillin, recombinant glutathione and insulin.

BBL432 Fluid Solid Systems

2 Credits (2-0-0)

Pre-requisite(s): CLL231

Size reduction; crushing and grinding; equipment for size reduction; screening; design procedure; Flow of fluids past a stationary particle for low, medium and high Reynolds numbers; sedimentation and sedimentation theory; thickeners and classifiers; flow through packed beds; flow distribution, packing and pressure drop calculations; fluidization; filtration theory and its application in plate and frame and rotary vacuum filters; solid-liquid separation using centrifugation; 'Δ' concept in centrifugation for scale-up; different types of centrifuges and their design; application for biological suspensions.

BBL433 Enzyme Science and Engineering

4 Credits (3-0-2)

Pre-requisite(s): BBL431

Introduction and scope; Chemical and functional nature of enzymes; Application of enzymes in process industries and health care; microbial production and purification of industrial enzymes; kinetics of enzyme catalysed reactions; immobilization of enzymes; stabilization of enzymes. Bioreactors for soluble and immobilized enzymes, mass transfer and catalysis in immobilized reactors. Enzyme based biosensors; enzyme catalysed process with cofactor regeneration; Enzyme reactions in micro-aqueous medium and non-conventional medium. Laboratory: Assay of enzyme activity and specific activity; kinetic analysis of an enzyme catalysed reaction; Immobilization of enzymes by adsorption and covalent binding; salt precipitation of an enzyme; immobilization of microbial cells by entrapment; effect of water and solvent on the lipase catalysed esterification reaction.

BBL434 Bioinformatics

3 Credits (2-0-2)

Pre-requisite(s): BBL131, BBL132

The topics include introduction to bioinformatics - resources and applications, Biological sequence analysis, sequence alignment, molecular phylogenetic analysis, genome organization and analysis, protein analysis, molecular modeling and drug design.

BBL441 Food Science and Engineering

3 Credits (3-0-0)

Chemical constituents of foods, their properties and functions; Characteristic features of natural and processed foods; Chemical/biochemical reactions in storage/handling of foods; Units operations in food processing- size reduction, evaporation, filtration etc.; Methods for food preservation; Rheology of food products; Flavour, aroma and other additives in processed foods; case studies of a few specific food processing sectors, cereals, protein foods, meat, fish and poultry, vegetable and fruit, milk products; legislation, safety and quality control.

BBL442 Immunology

4 Credits (3-0-2)

Pre-requisite(s): BBL131, BBL132, BBL231

Historical background, Innate and acquired immunity. Cells and organs of immune system. Molecules of immune system – immunoglobulins, MHCs, Cytokines, T cell receptors. Generation of antibody and T cell receptor diversity. Complement system. Humoral and Cell mediated immunity. Immune regulation. Vaccines. Hybridoma. Immunodeficiencies and AIDS. Transplantation immunity and cancer.

BBL443 Modelling and Simulation of Bioprocesses

4 Credits (3-0-2)

Pre-requisite(s): BBL331

Types of kinetic models, Data smoothing and analysis, Mathematical representation of Bioprocesses, Parameter estimation, Numerical Integration techniques, Parameter Sensitivity analysis, Statistical validity, Discrimination between two models. Case studies Physiological state markers and its use in the formulation of a structured model, Development of compartment and metabolic pathway models (Software Probe) for intracellular state estimation. Dynamic Simulation of batch, fed-batch steady and transient culture metabolism, Numerical Optimization of Bioprocesses using Mathematical models.

BBL444 Advanced Bioprocess Control

3 Credits (3-0-0)

Pre-requisite(s): CLL261

The course begins with an overview of classical control theory leading to a detailed analysis of the stability of biological systems. Lyapunov stability is introduced followed by concepts of nonlinear control theory and applications to bioreactors. Control loops in metabolic and protein networks are discussed in the background evolution and motifs selected by natural systems. This leads to the introduction of large protein interaction networks and study of their architectures. Applications of these ideas in a priori analysis of synthetic circuits are examined. The course ends with case studies from the literature.

BBL445 Membrane Applications in Bioprocessing

3 Credits (3-0-0)

Milk/cheese processing, Fruit/sugarcane juice processing, Pharmaceuticals/ Therapeutic drugs processing and membrane coupled separation of biomolecules; Membrane based bioreactor for cell/enzyme recycle; Mammalian/plant cell culture; Case studies.

BBL446 Biophysics

3 Credits (3-0-0)

Pre-requisite(s): PYL101, BBL131

Spectroscopic methods in biophysics, conformational changes in biological processes, biological energy conservation and transduction, photosynthesis, transport across biomembranes, the biophysics of motility, the biophysics of the nerve impulse, single molecule biophysical studies.

BBL447 Enzyme Catalyzed Organic Synthesis

3 Credits (2-0-2)

Pre-requisite(s): BBL131 and EC 90

Enzymes as biocatalysts. Various reaction media for enzyme catalyzed reaction [water, water poor media such as organic solvents, ionic liquids] and mixed solvents. Advantages of medium engineering. Fundamentals of non-aqueous enzymology [pH memory, molecular imprinting]. Improving biocatalysis in water and water poor media [chemical modification, immobilization, applications of protein engineering/directed evolution]. Enzyme promiscuity and its applications in organic synthesis. Biocatalytic applications in organic synthesis, hydrolytic reactions, oxidation reduction reactions, formation of C-C bond, addition and elimination reactions, glycosyl transfer reactions, isomerization, halogenation/dehalogenation reactions.

BBD451 Major Project Part 1 (BB1)

3 Credits (0-0-6)

BBD452 Major Project Part 2 (BB1)

8 Credits (0-0-16)

BBL731 Bioseparation Engineering

4.5 Credits (3-0-3)

Pre-requisite(s): BBL331, BBL432, BBL433

Characteristics of bio product, flocculation and conditioning of

fermented medium, Revision of mechanical separation (filtration, Centrifugation etc.), cell disruption, Protein precipitation and its separation, Extraction, Adsorption Desorption processes, Chromatographic methods based on size, charge, shape, biological affinity etc., Membrane separations- ultrafiltration and electrodialysis, Electrophoresis, Crystallization, Drying, Case studies. Laboratory: Conventional filtration batch & continuous, Centrifugation in batch and continuous centrifuge, Cell disruption, Protein precipitation and its recovery, Thin Layer Chromatography (TLC), Membrane based filtration- ultrafiltration in cross. Flow modules and microfiltration, electrodialysis, Adsorption Column Studies and Freeze Drying Studies.

BBL732 Bioprocess Plant Design

4 Credits (3-0-2)

Pre-requisite(s): APL100 CLL251 CLL252 BBL331 BBL432

Introduction; General design information; Mass and energy balance; Flow sheeting; Piping and instrumentation; Materials of construction for bioprocess plants; Mechanical design of process equipment; Vessels for biotechnology applications; Design considerations for maintaining sterility of process streams and processing equipment; Selection and specification of equipment for handling fluids and solids; Selection, specification and design of heat and mass transfer equipment used in bioprocess industries; Utilities for biotechnology production plants; Process economics; Bioprocess validation; Safety considerations; Case studies.

Laboratory: Design of the complete process plant for an identified product or service. Each student to choose a separate product/industry

BBL733 Recombinant DNA Technology

3.5 Credits (2-0-3)

Pre-requisite(s): BBL131, BBL132, BBL231 or Masters' degree in Bioscience

Restriction and other modifying enzymes, Cloning vectors (plasmid, (-based, phagemids, high capacity) and expression vectors, Expression in bacterial, yeast and mammalian systems, Construction of genomic and cDNA libraries, DNA Sequencing, Polymerase chain reaction, Invitro mutagenesis, Genome mapping, Stability of recombinant cells in production of biochemicals.

BBL734 Metabolic Regulation and Engineering

3 Credits (3-0-0)

Pre-requisite(s): BBL331, BBL431

Regulatory mechanisms for control of enzyme synthesis - an overview; Control of enzyme activity- proteolysis, covalent modification and ligand binding; Metabolic control theory and metabolic flux analysis; Metabolic regulation of a few major metabolic pathways especially those relevant to bioprocess industries; Pathway engineering; Application of gene cloning in re-directing cellular metabolism for over-production of a few industrial products; Strategies to overcome regulatory mechanisms for over-production of several industrially important primary and secondary metabolites such as alcohols, organic acids, amino acids, enzymes and therapeutic compounds.

BBL735 Genomics and Proteomics

3 Credits (2-0-2)

Pre-requisite(s): BBL231, BBL733

Introduction to -omes and -omics; GENOMICS - Genome sequencing and assembly; Next-generation sequencing; Studying gene expression and function; High throughput gene expression and analysis. PROTEOMICS - Sample preparation; Separation methods; Mass Spectroscopy and de novo sequencing; Comparative Proteomics; Protein-protein interactions.

BBL736 Dynamics of Microbial Systems

3 Credits (3-0-0)

Pre-requisite(s): BBL331, BBL432, BBL433

Stability analysis; analysis of multiple interacting microbial populations; stability of recombinant cells; Structured models of gene expression and growth, Cell cycle and age-dependent (segregated) models, Single-cell (stochastic) models of gene expression.

BBL737 Instrumentation and Analytical Methods in Bioengineering

3 Credits (2-0-2)

Pre-requisite(s): BBL131

Introduction to methods used in Analytical Bioengineering, Electrophoretic methods, Principles and applications of chromatography (GC, HPLC, FPLC, HPTLC), Spectrophotometry (UV-visible), Fluorescence methods, FTIR, Circular dichroism, Mass spectrometry (GC-MS, LC-MS, ICP-MS), Immunology based analytical methods (ELISA), qPCR, Advanced Microscopy techniques (Electron Microscopy, Confocal Microscopy).

BBL740 Plant Cell Technology

4 Credits (3-0-2)

Pre-requisite(s): BBL331

Special features and organization of Plant cells. Totipotency, regeneration of plants, Plant products of Industrial importance. Biochemistry of major metabolic pathways & products. Autotrophic and heterotrophic growth, Plant growth regulators and elicitors. Cell suspension culture development: nutrient optimization, growth and production kinetics, Two stage cultivation. Cell Characterization. Optimization strategies using suspension cultures for some plant metabolites. Biological and technological barriers-hydrodynamic shear assessment and its quantification, mixing and impeller design aspects. Novel designs of Plant cell reactors: comparison of reactor performances. Plant cell Immobilization protocols & their advantages. Immobilized plant cell & cell retention reactors. Design of spherical immobilized cell aggregates. Hairy root induction, Mass propagation in gas/liquid phase bioreactor configurations with case studies. Use of mathematical model based optimization for different cultivation strategies. Endophytes: In vitro platforms for production of plant secondary metabolites with case histories.

Laboratory: Importance of nutrients, role of different media in growth of different plants parts, Preparation of media; Development of callus of a plant; Development of homogenous shake flask suspension culture of plant cells; Study of growth, product formation kinetics of suspension culture; Study of shear sensitivity of plants cells by viability assessment; Propagation of plant cells in bioreactors and assessment of key kinetic parameters; Hairy root induction of a plant; Analysis of plant cell/hairy root metabolites.

BBL741 Protein Science and Engineering

3 Credits (3-0-0)

Pre-requisite(s): BBL131 BBL231 or Masters' degree in Bioscience

Introduction and aim; Basic structural principles of proteins-amino acids; Motifs of protein structure and their packing: alpha domain, alpha/Beta domain, Antiparallel B structures; Protein folding and assembly – protein folding pathways for single and multiple domain proteins; Recovery of active proteins from inclusion bodies; Structure prediction-structural classes, secondary and tertiary protein structure prediction; Sequence homology searches; Strategies for protein engineering – random, site-directed, case studies; Drug-protein interactions and design, Rational protein design.

BBL742 Biological Waste Treatment

4 Credits (3-0-2)

Pre-requisite(s): BBL132, BBL331 or Bachelor's degree in Engineering or Masters' degree in Science

Qualitative and quantitative characterization of wastes; Waste disposal norms and regulations; Indian regulations; Principles of biological treatment; Aerobic and anaerobic biological wastewater treatment systems; Suspended and attached cell biological wastewater treatment systems; Biological nutrient removal; Treatment plant design calculations; Treatment and disposal of sludge; biological means for stabilization and disposal of solid wastes; Treatment of hazardous and toxic wastes; Degradation of xenobiotic compounds; bioremediation. Laboratory: Characterization of wastes; Design calculations for various types of wastes using various types of biological processes.

BBL743 High Resolution Methods in Biotechnology

3 Credits (2-0-2)

Pre-requisite(s): BBL131, BBL331 or Masters' degree in Bioscience

Need for high resolution separation for biologicals; Difficulties with traditional methodologies; Affinity precipitation and partitioning; MF/UF/NF for high resolution separation; chromatography techniques; Affinity chromatography and electrophoresis, Separation by gene amplification (PCR), Molecular imprinting.

BBL744 Animal Cell Technology

4 Credits (3-0-2)

Characteristic of animal cell, metabolism, regulation and nutritional requirements; Kinetics of cell growth and product formation and effect of shear force; Product and substrate transport; Perfusion bioreactors, Hollow fiber bioreactor, Operational strategies and integrated approach; Micro and macro carrier culture; Hybridoma technology; Genetic engineering in animal cell culture; Scale-up and large scale operation; Case studies.

Laboratory: Cell culture in static phase (T-flask), quantification of cell growth, monolayer culture, determination of critical shear stress, micro carrier, Cell viability assay. Case studies to understand growth kinetics and product kinetics in actual cell culture system.

BBL745 Combinatorial Biotechnology

3 Credits (3-0-0)

Solid phase synthesis, solution phase synthesis, encoding technologies, deconvolution methods, Tools for Combinatorial Biotechnology, Display libraries, Applications.

BBL746 Current Topics in Biochemical Engineering and Biotechnology

3 Credits (3-0-0)

*Pre-requisite(s): BBL131, BBL331***BBL747 Bionanotechnology**

3 Credits (3-0-0)

Pre-requisite(s): BBL131 or Masters' degree in Bioscience

Introduction, Self-assembly of biomolecules in nanotechnology; Bacterial S-Layer, Biomimetic Ferritin, Biodegradable nanoparticles for drug delivery to cells and tissues, Polymer Nanocontainers, Ion channels as molecular switches, Patch clamp technique, Protein based nanoelectronics, Bacteriorhodopsin and its technical applications, Carbon Nanotubes: Towards next generation biosensors, Molecular Lego: Design for molecular actuators, Biological Membranes, Magnetosomes: Trapping nano-magnetite in biological membranes, Biomolecular Motors, Techniques used in Bionanotechnology Nanoanalytics: Fluorescent Quantum Dots for Biological Labelling, Nanoparticle Molecular Labels.

BBL748 Data Analysis for DNA Microarrays

4 Credits (3-0-2)

Pre-requisite(s): BBL131, BBL231, BBL733

Microarray technology, Basic digital imaging and image processing, Probabilities, common distributions, Bayes' theorem, Analyzing microarray data with classical hypothesis testing, Analysis of variance, Experimental Design, Analysis and visualization tools: Box plots, Scatter plots, Histograms, Cluster Analysis: one-way, two-way, Graphic, Methods for selection of differentially regulated genes, Hypothesis driven experiments using focused microarrays, Biological interpretation, Commercial software available.

BBL749 Cancer Cell Biology

4.5 Credits (3-0-3)

Pre-requisite(s): BBL131 BBL132 BBL231

This course provides students with a deeper understanding of cancer biology and is heavily focused on experiments: Topics include: Cancer Biology Overview, Types of Cancer, Causes for cancer, Oncogenes and Tumor suppressors, Cell Cycle and Regulation, Cell Differentiation, Cell

Death Pathways (Apoptosis, Autophagy), Necrosis, Cell Senescence, Cell Adhesion and Motility, Cancer Epigenetics and sRNAs, Cancer Genome instability, Tumor Immunity, Growth Signaling pathways, Tumor angiogenesis, Cancer Stem Cell, Diagnosis, prognosis and treatment of cancer.

Laboratory: Experiments on Cell cycle, Differentiation, Necrosis and Apoptosis, Senescence, Anchorage Independence, Cell Migration and Invasion, MicroRNAs, Stem cell, Fluorescence Microscopy.

BBL750 Genome Engineering

3 Credits (2-0-2)

Genome engineering methods for bacteria, yeast, plants and mammalian cells, Newer gene delivery methods, Next generation cloning technologies.

BBL751 Biotechnology Entrepreneurship

2 Credits (2-0-0)

Introduction to biotechnology. Agri, Medical and Environment sectors. Role of innovation, evaluating business idea and potential, Legality behind company formation, team for delivery, business plan, IPR issues, licensing, capital and investors, regulatory approvals and good manufacturing principles.

BBL752 Microbial Ecology

3 Credits (3-0-0)

Pre-requisite(s): BBL132

Microbial diversity, interactions, communities; Microbial community structure vs. function; Microbiomes in natural ecosystems: terrestrial and aquatic, extreme environments; Interactions of microbiomes with higher organisms (Humans and Plants); Microbial functions in biogeochemical cycles; Methodological advances in Microbial Ecology; Novel strategies for culturing the "unculturable", Era of "Omics", Quantitative and qualitative methods for characterization of microbial communities; Role of microbial ecology in crucial environmental issues, viz. climate change, sustainability, pollution.

BBL754 Optics within Life Science

3 Credits (3-0-0)

Pre-requisite(s): BBL132

Course will cover nature of light-matter interaction, fundamentals of absorbance, fluorescence and scattering. All the components in spectroscopic and imaging technologies i.e., light source to detectors will be discussed. Properties of optical probes, various spectroscopic and imaging techniques used to study biological samples. Including; confocal, TIRF, non-linear, in vivo, super resolution and single molecule imaging.

BBL756 Plasmid Biology

3 Credits (3-0-0)

Pre-requisite(s): BBL231

Plasmid nomenclature, classification, replication, segregation, incompatibility, stability, host range, significance in environment, health and biotechnology.

BBV750 Bioreaction Engineering

1 Credit (1-0-0)

Pre-requisite(s): Undergraduate or M.Sc. level in Biochem/Biology or Chem. Engg.

Definitions of volumetric and specific rates. Yield and productivity of bioprocesses. Coupling of steady state black box stoichiometrics. Metabolic Flux Analysis. Transient operation, and the sensitivity of coupled enzymatic reactions to changes in the pathway flux. Design of bio-reactors with volumetric isotropy. The role of mixing in industrial bio-reactions. Large scale processes.

BBL810 Enzyme and Microbial Technology

3 Credits (3-0-0)

Isolation, development and preservation of industrial microorganisms;

Substrates for industrial microbial processes; Regulatory mechanisms of metabolic pathways in industrial strains; Analysis of various microbial processes used in production of biomass, primary and secondary metabolites; Microbial leaching of minerals; Microorganisms in degradation of xenobiotics and removal of heavy metals; Biotransformations. Enzymes as industrial biocatalysts; production; isolation; purification and application of industrial enzymes; immobilized enzymes; stabilization of enzymes; enzyme catalyzed organic synthesis; multienzyme systems.

BBL820 Downstream Processing

3 Credits (3-0-0)

Characteristics of biological materials; Pre-treatment; Microbial separation: Centrifugation and filtration, Cell disruption methods, Protein precipitation, Extraction, Adsorption, Electrophoresis, Chromatography, Ultrafiltration, Reverse osmosis, Isoelectric focusing, Affinity based separations, Case Studies.

BBL830 Microbial Biochemistry

3 Credits (3-0-0)

Structure and function of biomolecules amino acids, proteins, lipids, nucleotides and nucleic acids: Enzymes-structure and kinetics, Vitamins and coenzymes, Metabolic pathways: Carbohydrate metabolism: glycolysis, pentose phosphate pathway, citric acid cycle; Bioenergetics oxidative phosphorylation and photo-synthesis: Fatty acid metabolism; Amino acid metabolism; Regulatory mechanisms-feedback inhibition, induction, catabolite repression; Nucleic acid and protein biosynthesis.

BBP840 Laboratory Techniques in Microbial Biochemistry *2 Credits (0-0-4)*

Estimation of carbohydrates/proteins/nucleic acids; separation of phospho-lipids by thin layer chromatography; chromatographic separation of proteins; identification and estimation of intermediates of glycolytic pathway; oxidative phosphorylation; cell fractionation; aseptic techniques; microscopic examination of bacteria & fungi; selected biochemical tests; plasmid DNA preparation; expression of cloned DNA in bacteria; isolation of auxotrophic mutants.

BBL850 Advanced Biochemical Engineering

5 Credits (3-0-4)

Kinetics of cell growth; Mathematical models for substrate uptake and product formation; Plasmid stability in recombinant cell cultures; Kinetics of enzyme-catalyzed reactions; Media and air sterilization; Cell cultivation strategies; Novel bioreactor designs; Developments in aeration & agitation in bioreactors; immobilized whole cell and immobilized enzyme reactors; RTD and mixing in bioreactors; Dynamics of mixed cultures; Scale-up and scale down of bioreactors.

Laboratory: Microbial growth and product formation kinetics; enzyme kinetics; Effects of inhibitor on microbial growth; enzyme immobilization techniques; Bioconversion using immobilized enzyme preparation; Bioconversion in batch, fedbatch and continuous bioreactors; Oxygen transfer studies in fermentation; Mixing and agitation in fermenters; RTD studies; Mass transfer in immobilized cell/enzyme reactors.

Department of Chemical Engineering

CLL110 Transport Phenomena

4 Credits (3-1-0)

Vector and tensor analysis. Euler/Lagrangian viewpoint of momentum transport, stress tensor and Newton's law of viscosity, shell momentum balances. Derivation of equations of change for isothermal, non-isothermal, and multicomponent systems. Solutions to 1D flow problems involving Newtonian or non-Newtonian fluids, friction factor. Mechanisms of energy transport, energy flux for conduction, convection and viscous dissipation, solutions to 1D conduction and convection problems. Mechanisms of mass transport, mass and molar diffusion fluxes, derivation and application of continuity equation to mass transfer in binary mixtures. Dimensional analysis of equations of change to solve higher dimensional transport problems. Unsteady-state momentum, heat, and mass transport.

CLL111 Material and Energy Balances

4 Credits (2-2-0)

Mathematics and engineering calculations, dimensional groups and constants. Vapour pressure; Clausius-Clapeyron equation, Cox chart, Duhring's plot, Raoult's law. Humidity and saturation, humid heat, humid volume, dew point, humidity chart and its use. Crystallization, dissolution. Ideal gas behavior. Material balance: solving material balance problems with and without chemical reaction, recycle, bypass and purge calculations, aid of computers in solving material balance problems. Energy balance: closed and open systems, heat capacity, calculation of enthalpy changes, energy balances with chemical reaction, heat of vaporization, heat of formation, heat of combination, heat of reaction.

CLL113 Numerical Methods in Chemical Engineering

4 Credits (3-0-2)

Overlaps with: MTL107, MTP290, MTL445, CVL734, COL726
Estimation and round-off error calculations. Solution of linear algebraic equations via Gauss elimination, matrix inversion and LU decomposition, Gauss-Seidel method. Solving non-linear algebraic equations with the help of root finding. Numerical integration and differentiation. Solution of ordinary differential equations encountered in initial/boundary value problems via implicit and explicit methods, solution of partial differential equations, Chemical engineering problems where the above mentioned numerical schemes are involved will be illustrated.

CLL121 Chemical Engineering Thermodynamics

4 Credits (3-1-0)

Overlaps with: MCL140, MCL141, MCL142

Review of conservation of energy, mass and introduction to work-energy conversions, and the concept of entropy. Application to closed and open systems, application in analysis of energy and efficiency of equipment. State and properties of pure fluids under different conditions and in flow through equipment. Use of equations of states, graphs, correlations and tables to estimate fluid properties, understanding the relationships between fluid properties and changes in properties. Equilibrium properties of pure materials and mixtures. Understanding the phase behaviour and phase transitions of pure fluids. Thermodynamic analysis of fluids in standard fixtures and equipment (piping fixtures, power plants, engines, refrigerators). Equilibrium behaviour of mixtures of fluids, the nature of interactions between various fluids and how interactions affect their properties and phase transitions. Introduction to separation processes based on difference in equilibrium thermodynamic properties. Introduction to reaction equilibria.

CLL122 Chemical Reaction Engineering I

4 Credits (3-1-0)

Introduction to rate equations, calculation of conversion in single reaction, kinetics of homogeneous reactions. Derivation of reactor design equations, analysis and sizing of reactors, data collection and plotting to determine rate constants. Reactor networks (series/parallel), concepts of selectivity and yield, reaction mechanisms.

Temperature and pressure effects on reactions and reactor design, simultaneous material and energy balances, multiple steady-states. Residence time distributions in non ideal reactors.

CLL133 Powder Processing and Technology

3 Credits (3-0-0)

Powder characterization for size, shape, surface area and flowability and relation between them. Characterization techniques: light scattering, light extinction, sedimentation, ultrasonic methods. Powder storage: designing of silos, flow of powders, measurement of flow factors, analytical methods for flow problems in chutes, cyclones and silos, funnel and mass flow. Segregation of powder during flow through chutes and air-induced flows. Segregation during heap formation. Comminution equipment: selection and designing. Particle size control in grinding circuit analysis. Gas-solid separation equipment, application for pollution control.

CLL141 Introduction to Materials for Chemical Engineers

3 Credits (3-0-0)

Brief introduction to crystalline solids - metals and semiconductors, types of atomic bonding and lattices. Semi-crystalline materials - ceramics, polymers, copolymers, liquid crystals and surfactants. Amorphous and composite systems such as glass, fibers, granular materials, matrices and alloys. Role of materials selection in design, structure-property-processing-performance relationships. Materials characterization via experimental techniques. Special materials like biomaterials and zeolites.

CLL222 Chemical Reaction Engineering II

3 Credits (3-0-0)

Pre-requisite(s): CLL122

Definition of catalysis, homogeneous and heterogeneous catalysis. Adsorption on catalytic surfaces, kinetic models, catalyst preparation, physical characterization of catalysts, supported metal catalysts. Mass transfer and internal diffusion effects in catalytic reactions, Thiele modulus and effectiveness factor, falsification of kinetics, catalyst deactivation.

Packed bed reactor design, introduction to other multiphase reactors, gas-liquid reactors and enhancement factor. Gas-solid non-catalytic reactions.

CLL231 Fluid Mechanics for Chemical Engineers

4 Credits (3-1-0)

Pre-requisite(s): CLL110

Overlaps with: APL107, APL106, APL105

Introduction to fluids, Forces on fluids, Fluid statics, Hydrostatic force on submerged bodies, Rigid body motion, Kinematics of flow - Eulerian and Lagrangian descriptions, Flow visualization, Integral analysis - mass and momentum balances, Bernoulli equation, Flow through pipes and ducts, Flow measurement, Flow transportation - pumps, blowers and compressors, Differential analysis of flow, Conservation of mass, linear and angular momentum, Navier-Stokes equation, Unidirectional flows, Viscous flows, Skin friction and form friction, Lubrication approximation, Potential flows, Boundary layer theory, Blasius equation for flow over a flat plate, Boundary layer separation, Drag and lift force on immersed bodies, Similitude analysis, Turbulent flows.

CLL251 Heat Transfer for Chemical Engineers

4 Credits (3-1-0)

Pre-requisite(s): CLL110

Overlaps with: MCL242

Modes of heat transfer - conduction, convection, radiation; Heat transfer coefficients in natural and forced convection; Basic conservation equations; Heat transfer with phase change; Design of double pipe heat exchangers, shell and tube heat exchangers and evaporators; Introduction to radiative heat transfer. Unsteady state heat transfer. Two-dimensional heat transfer problems.

CLL252 Mass Transfer I

3 Credits (3-0-0)

Pre-requisite(s): CLL110

Lattice, Fick's, Stefan-Maxwell, Stokes-Einstein and irreversible thermodynamic approaches to diffusivity of binary and multicomponent system. Film theory and other theories of mass transfer. Analogy and correlation approaches to mass transfer coefficients in interphase mass transfer. Analysis of co-current, counter-current and cross flow stage cascades. Design and operating conditions of differential contact equipment such as packed towers for absorption, adsorption, drying and leaching.

CLL261 Process Dynamics and Control

4 Credits (3-1-0)

*Pre-requisite(s): MTL100, CLL111**Overlaps with: MCL212, ELL225, ELL205*

Introduction to automation, block diagrams; revision of Laplace transform. Modeling based on transfer function approach, open-loop systems: dynamic response of first order systems, first order systems in series, second order systems, and transportation lag. Feedback control: P, PI, PID controllers. Dynamic response of closed loop systems Linear stability analysis: Routh stability criterion, root locus diagrams. Frequency response: Bode diagrams, Nyquist diagrams, Bode and Nyquist stability criterion. Controller tuning: Zeigler-Nichols and Cohen-Coon methods. Introduction to advanced control: feedforward control, cascade control, dead time compensation, ratio control, internal model control.

CLL271 Introduction to Industrial Biotechnology

3 Credits (3-0-0)

*Pre-requisite(s): CLL110**Overlaps with: BEN150, BBL431, BBL731*

Introduction to biopharmaceutical industry. Monod kinetics. Michaelis-Menten kinetics. Introduction to the different bioprocessing unit operations utilized in production of biotech drugs - upstream, harvest, and downstream. Design, control and scale up of bioreactor. Introduction to analytical methods used for characterization of biotech products and processes (high performance liquid chromatography, mass spectrophotometry, capillary electrophoresis, near infrared spectroscopy, UV spectroscopy). Fundamentals and design of filtration and other membrane based separation techniques. Process chromatography - theory, practice, design and scale-up. Mixing, heat transfer and mass transfer in bioprocessing unit operations. Scale-up of filtration and chromatography unit operations utilized in bioprocessing: procedures, issues that frequently occur and possible solutions. Process design, control and optimization. Current topics in biopharmaceutical technology.

CLL296 Nano-engineering of Soft Materials

3 Credits (3-0-0)

*Pre-requisite(s): CLL121**Overlaps with: PYL421*

Mathematical characterization of phase transitions in soft matter, e.g. thin films, polymers and colloidal suspensions. Universality in phase separation kinetics. Evolution of order parameter. Time dependent mean field theories (MFTs). Kinetically-driven morphological changes in nano-pattern formation in thin films. Colloidal crystallization and at liquid fronts. Field-induced effects on assembly in complex fluids.

CLP301 Chemical Engineering Laboratory I

1.5 Credits (0-0-3)

Pre-requisite(s): CLL231, CLL251

Practicals in fluid mechanics and heat transfer.

CLP302 Chemical Engineering Laboratory II

1.5 Credits (0-0-3)

Pre-requisite(s): CLL331, CLL252

Practicals in unit operations, mechanical operations, fluid-particle mechanics and principles of mass transfer.

CLP303 Chemical Engineering Laboratory III

1.5 Credits (0-0-3)

Pre-requisite(s): CLL121, CLL122, CLL222

Practicals in reaction engineering, thermodynamics and chemical processing.

CLL331 Fluid-Particle Mechanics

4 Credits (3-1-0)

Pre-requisite(s): CLL110, CLL231

Introduction to industries dealing with the particles (solid, liquid, gas, soft-materials: colloids, polymer), solid particles: particle size, shape and their distribution, relationship among shape factors and particle dimensions, specific surface area, measurement of surface area and particle size distribution, drag coefficient, packed bed, fluidization. Sedimentation: settling, hindered settling, design of settling tank, filtration, centrifugal separation, cyclone separator, mixing (solid-solid, solid-liquid and liquid-liquid), segregation. Size reduction, size enlargement, flow properties of slurries, behaviour of colloidal particles in dispersed condition.

CLL352 Mass Transfer II

4 Credits (3-1-0)

Pre-requisite(s): CLL252

Review of VLE. Separation quantification: separation factor, relative volatility, key components, flash: graphical and algebraic (Richford-Rice) method. Differential distillation, binary distillation: McCabe-Thiele method - minimum reflux, minimum number of stages, open steam, multiple feeds, side streams. Packed columns - HETP, HTU method. Column pressure. Tray efficiency. Column sizing, sieve tray design, packed column design.

LLE - equilibrium diagram, selection of solvent, design calculations for single stage, cascade of stages using Hunter and Nash graphical method, McCabe-Thiele method, continuous contacting.

Multicomponent system: selection of key components, approximate - FUG method, DOF for cascade of stages, MESH formulation, introduction to azeotropic and extractive distillation, adsorption equilibrium, breakthrough curve.

CLL361 Instrumentation and Automation

2.5 Credits (1-0-3)

Pre-requisite(s): CLL261

Signals and standards (pneumatic, voltage, current). Basics of control loop components: sensors, transmitters, transducers, control valves, and converters. Measurement devices for process variables: temperature, pressure, level, flow, pH, humidity, density, and viscosity. Control valves, actuators, positioners; computer-based control systems: PLC, DCS, SCADA.

CLL371 Chemical Process Technology and Economics

4 Credits (3-1-0)

Pre-requisite(s): CLL252, CLL122

Introduction to process flowsheet, equipment symbols and sections of a chemical plant. Use of flowsheeting software. Process synthesis and process flow diagrams of chemical plants (gas-liquid, liquid-solid, gas-liquid-solid handling plants). Fertilizer technology: manufacture of fertilizers including naphtha reforming, air separation, ammonia synthesis technology. Utilities and safety issues in fertilizer plants. Chlor-alkali and sulfuric acid manufacturing. Refining and petrochemical technology: Crude occurrence, properties, distillation, refinery processes and technology, petrochemical technologies. Semiconductor chip manufacturing. food technology. Safety and hazard analysis, and debottlenecking of chemical plants. Introduction to process engineering economics.

CLL390 Process Utilities and Pipeline Design

3 Credits (3-0-0)

Pre-requisite(s): CLL231

Transportation and measurement of utilities like air, water and steam.

Handling of steam. Design of insulation for steam carrying pipes, water hammer. Design of flash tank. Water treatment and reduction of scaling. Storage tank analysis for water. Piping network design, fittings and valves. Air treatment: cleaning and Dehumidification, design of refrigeration and air-conditioning systems. Transportation of air: duct design, selection of blowers and compressors. Instrumentation and control for fluid transportation. Energy audit for industrial air and steam handling systems.

CLL402 Process Plant Design

3 Credits (3-0-0)

Pre-requisite(s): CLL371

Overlaps with: CLL703

Plant layout and flowsheeting. Issues related to materials handling, equipment selection and design (pumps, blowers and compressions, mixers, conveyors, separation columns, reactors), utilities and auxiliaries, offsite facilities. Cost estimation. Selection and detailed design of equipment. Steam handling. Valves, piping and instrumentation. Environmental footprint assessment, pollution reduction, and life cycle analysis of process plant.

CLD411 B. Tech. project

4 Credits (0-0-8)

Formulation of the problem. Literature search. Design and fabrication of the experimental setup. Study of experimental techniques in the case of experimental projects. Formulation of equations and analytical/numerical solution in case of modeling projects. Development of software. Analysis of results. Presentation of results and scientific reporting in form of thesis and presentation.

CLD412 Major Project in Energy and Environment

5 Credits (0-0-10)

Pre-requisite(s): CLD411

CLD413 Major Project in Complex Fluids

5 Credits (0-0-10)

Pre-requisite(s): CLD411

CLD414 Major Project in Process Engineering, Modeling and Optimization

5 Credits (0-0-10)

Pre-requisite(s): CLD411

CLD415 Major Project in Biopharmaceuticals and Fine Chemicals

5 Credits (0-0-10)

Pre-requisite(s): CLD411

CLL475 Safety and Hazards in Process Industries

3 Credits (3-0-0)

Pre-requisite(s): CLL371

Loss statistics and prevention. Fires and explosions. Hazards related to static electricity. Safety system designs for prevention of fire and explosions. Hazards due to toxicity. Industrial hygiene. Hazards identification and risk assessment methods. Event probability and failure frequency analysis. Case studies.

CLL477 Materials of Construction

3 Credits (3-0-0)

Pre-requisite(s): CLL371

Types and mechanisms of corrosion, factors influencing corrosion. Corrosion testing methods. Combating corrosion in metals and non-metals. High and low temperature materials. Selection of materials of construction for handling different chemicals. Industrial applications and case studies.

CLL701 Modelling of Transport Processes

2 Credits (2-0-0)

Overlaps with: CLL110, CLL113, MTL107, MTL445, COL726

Fundamentals of momentum transport, Mass and momentum conservation equations and their application to solve 1-D problems, Fundamentals of heat transport, Equation of energy/temperature and its application to solve problems involving conduction, Fundamentals of mass transport, Equation of mass conservation and its application to solve problem involving binary diffusion.

Introduction to methods for solution of algebraic equations, Methods for solution of ODEs, Functions, approximations and regression analysis, Introduction to Design of Experiments.

CLL702 Principles of Thermodynamics, Reaction Kinetics and Reactors

2 Credits (2-0-0)

Overlaps with: CLL121, CLL122, MCL140, MCL141, MCL142

Introduction to thermodynamics; Notion of equilibrium, states and reversibility; First and Second Laws of Thermodynamics; Equation of state; Equilibrium behavior of mixtures of fluids; Phase equilibria and VLE; Reaction thermodynamics.

Reaction equilibria and chemical kinetics; Ideal reactors; Isothermal reactor design; Temperature and pressure effects in Ideal reactors; Heterogeneous catalysis and effectiveness factors; Fluid-solid non-catalytic reactions.

CLL703 Process Engineering

3 Credits (3-0-0)

Process synthesis, material balances and decision making in reactors with recycle streams, input-output structure of flowsheet for batch vs. continuous reactors, hierarchical approach for process engineering design, reactor and separation system selection guidelines, distillation column sequencing, heat exchanger network design, pinch technology, utility selection, grand composite curve, steam and cooling water circuits, integration of heat pumps and heat engines

Process economics: Cost estimation, annuities, perpetuities and present value, tax and depreciation, profitability measures, comparison of equipments and projects, NPV, IRR, risk management.

Process modeling tools: AspenPlus® or Promax that are used in industry for large scale problem solving to undertake problems of current interest.

CLP704 Technical Communication for Chemical Engineers

1 Credit (0-0-2)

Technical paper and report writing, Knowledge of leading Chemical Engineering journals and conferences, carrying out literature search, research methodology, paper referencing and critiquing, ethics and plagiarism, improving presentation and communication skills.

CLL705 Petroleum Reservoir Engineering

3 Credits (3-0-0)

Pre-requisite(s): CLL110, CLL121

Introduction of static model including porosity, permeability, compressibility and saturations. Crude oil phase behaviour and their measurement techniques for reservoir and laboratory settings. Meaning and calculation of 'oil in place' numbers with respect to different recovery mechanisms. Material balance for hydrocarbon reservoirs. Pressure transient analysis. Primary, secondary and tertiary recovery mechanisms, Buckley- Leverett theory (fractional flow curves) for immiscible and miscible displacement. Production forecasting and introduction to reservoir simulation.

CLL706 Petroleum Production Engineering

3 Credits (3-0-0)

Pre-requisite(s): CLL231, CLL121

Basic concepts: well drilling, well completions, drive mechanisms

for different reservoirs, Darcy's law. Movement of fluids in the well, different artificial lift mechanisms, VLP (vertical lift performance curves), IPR (inflow performance relationships). Well analysis tools (different well performance curves, well logging). Problem identification in wells (examples). Well stimulation techniques.

CLL707 Population Balance Modeling

3 Credits (3-0-0)

Pre-requisite(s): MTL101, CLL331, CLL352

Theory of crystallization. Particle size distribution, particle phase space. Population balance equation for convection in state space (pure growth). Solution of PBE using method of characteristics. PBE with breakage and coalescence/aggregation terms. Scaling theory and phenomenological models for rate of breakage and coalescence induced by turbulence. Solution of PBE for pure breakage and pure coalescence. Moment transformation of PBE. Numerical approaches to solve PBE. Integrating PBE with transport equations.

CLL720 Principles of Electrochemical Engineering

3 Credits (3-0-0)

Volta and Galvani potentials, electrochemical potential, electrochemical equilibrium, Nernst equation. Born-Haber cycle for enthalpy and Gibbs free energy calculation, conventions for ionic species, solvation energy, ionic equilibrium. Electrochemical cell, standard electrode potential, Pourbaix diagram, Donnan potential, reversible electrode. Born model for ion-solvation energy. Ion-ion interactions: Debye-Huckel theory, activity coefficient of ionic solution, ion pair, Bjerrum theory and Fuoss theory. Ionic transport: migration, extended Nernst-Planck equation, electrochemical mobility and its relation with diffusivity, Stokes-Einstein equation, ionic conductivity, transport number, Kohlrausch law. Charged interface: surface excess quantity, Lippmann equation, Gouy-Chapman model, Stern layer, internal and external Helmholtz layer, zeta potential, energy of double layer. Electrokinetic phenomena: Non-equilibrium formulation, diffusion potential, junction potential, Planck-Henderson equation, pH electrode, electroosmosis, electrophoresis, streaming potential, sedimentation potential. Introduction to electrode kinetics: Butler-Volmer formulation, Tafel equation.

CLL721 Electrochemical Methods

3 Credits (3-0-0)

Galvani Potential, Butler-Volmer Equation, Tafel Equation. Potential Step voltammetry, pulse voltammetry, cyclic voltammetry. Controlled current methods, current-interrupt measurements. Conductivity relaxation, impedance spectroscopy. Coulometric methods, scanning probe techniques, spectro-electrochemistry.

CLL722 Electrochemical Conversion and Storage Devices

3 Credits (3-0-0)

Electrochemical cell, fuel cells, proton exchange membrane fuel cells, solid oxide fuel cells. Batteries, lead acid battery, Nickel-metal hydride (Ni-MH) rechargeable batteries, lithium-ion rechargeable batteries, liquid-redox rechargeable batteries. Electrochemical supercapacitors. Solar cells. Electrodialysis and reverse electrodialysis. Electrochemical hydrogen production and storage.

CLL723 Hydrogen Energy and Fuel Cell Technology

3 Credits (3-0-0)

Overview of fuel cells: low and high temperature fuel cells. Fuel cell thermodynamics – heat and work potentials, prediction of reversible voltage, fuel cell efficiency. Fuel cell reaction kinetics – electrode kinetics, overvoltages, exchange currents. Electrocatalysis - design, activation kinetics. Fuel cell charge and mass transport - transport in flow field, electrode and electrolyte. Fuel cell characterization- in-situ and ex-situ characterization techniques, I-V curve, application of voltammetry and frequency response analyses. Fuel cell modeling and system integration. Fuel cell diagnostics. Balance of plant. Different routes of hydrogen generation: electrolysis versus reforming for hydrogen production, solar hydrogen. Hydrogen storage and transportation, safety issues. Cost expectation and life cycle analysis.

CLL724 Environmental Engineering and Waste Management

3 Credits (3-0-0)

Overlaps with: CVL100, CVL212, CVL311, CVL312, BBL742

The course covers the concept of ecological balance and the contribution of industrial and human activities in the changes of the environmental quality. Ecological cycles. Concept of pollutants and regulatory measures for the maintenance of environmental quality. Air pollution sources and its dependence on the atmospheric factors, atmospheric stability and dispersion of pollutants. Control of emission of pollutants using multi-cyclone systems, electrostatic precipitators, bag filters, wet scrubbers for gas cleaning, adsorption by activated carbon etc. Water pollution, its causes and effects. Pollutants and its dispersion in water bodies to predict water quality through modeling. Concept of inorganic and organic wastes and definition of BOD and COD. Control of water pollution by primary treatment and biological treatment systems. Solid waste management systems. Hazardous waste treatment, disposal and storage in engineered landfill.

CLL725 Air Pollution Control Engineering

3 Credits (3-0-0)

Pre-requisite(s): CLL222

Overview of air pollution from mobile and stationary sources. Modeling of emission profile from IC engine. Effect of fuel type and quality and engine performance on air quality. Automotive catalysts and monoliths. Diesel particulate filters and their operation. Selective catalytic reduction. Stationary sources of air pollutants. Household pollutants and control of indoor air quality. Control of pollutants from power plants.

CLL726 Molecular Modeling of Catalytic Reactions

3 Credits (3-0-0)

Pre-requisite(s): CLL222

Sabatier principle. Catalytic cycle, transition state theory. Ensemble effect, defect sites, cluster size effects, metal-support interactions, structural effects, quantum size effects, electron transfer effects. Brønsted-Evans-Polanyi relations. Reactivity of transition-metal surfaces, quantum chemistry of chemical bond, bonding to transition metals, chemisorption.

Kinetics of elementary steps (adsorption, desorption and surface reactions). Reaction on uniform and non-uniform surfaces. Structure-sensitive and non-sensitive reactions on metals.

Electronic structure methods, potential energy surface, Born-Oppenheimer approximation, Hartree-Fock theory, self-consistent field, Kohn-Sham Density Functional Theory, Bloch's theorem and plane wave basis set, exchange-correlation functionals, pseudo-potential. Search for transition state, dimer method, nudged elastic band method, density of states.

Catalysis by metals, oxides, sulfides and zeolites. Aqueous phase heterogeneous catalysis and electrocatalysis.

CLL727 Heterogeneous Catalysis and Catalytic Reactors

3 Credits (3-0-0)

Pre-requisite(s): CLL222

Overlaps with: Basic concepts in heterogeneous catalysis, catalyst preparation and characterization, poisoning and regeneration. Industrially important catalysts and processes such as oxidation, processing of petroleum and hydrocarbons, synthesis gas and related processes. Commercial reactors: adiabatic and multi-tubular packed beds, fluidized bed, trickle-bed, slurry reactors. Heat and mass transfer and its role in heterogeneous catalysis. Calculations of effective diffusivity and thermal conductivity of porous catalysts. Reactor modeling. Chemistry and engineering aspects of catalytic processes along with problems arising in industry. Catalyst deactivation kinetics and modeling.

CLL728 Biomass Conversion and Utilization

3 Credits (3-0-0)

Pre-requisite(s): CLL122

Critical analysis of issues associated with implementing large scale

biofuel and biomass energy production. Processes for converting feedstocks to biofuels by thermochemical methods. Biomass conversion catalysis, kinetics and reaction mechanisms, reactor design and scale up issues.

CLL729 Colloids and Aerosols

3 Credits (3-0-0)

Pre-requisite(s): CLL231, CLL331

Creeping flows around a sphere. Drag and lift forces acting on particles in viscous fluids. Brownian motion of small particles. Colloidal interactions like van der Waal forces, electrostatic forces, depletion interactions, steric hindrance. Introduction to aerosols and colloids. Rheology of dilute, concentrated suspensions of spherical particles. Dynamics of nonspherical particles in viscous fluids. Rheology of non-spherical particles. Coagulation/coalescence due to differential settling, shear flow, Brownian diffusivity. Methods of preparation of emulsions, high energy and low energy. Microemulsions vs nanoemulsions. Aerosol characterization, transport of particulate matter in air via diffusion, convection and inertia, removal of particles via dry and wet deposition. Formation of aerosol (or colloidal) particles via nucleation and growth. Population balance equation. Experimental techniques for aerosol chemical characterization.

CLL730 Structure, Transport and Reactions in BioNano Systems

3 Credits (3-0-0)

Pre-requisite(s): CLL110

Overlaps with: SBV882, MCL442

Introduction to biology: protein structure, composition, pKa and isoelectric point. Governing equations applied to biological systems: conservation laws, flux equations, mathematical functions and solutions, scaling and order, laminar flow. Electromechanical transport: biomolecular migration through blood capillaries, Poisson-Boltzmann equation in heterogeneous media, electrical-shear stress balance in electrical double layers. Transport across membranes: structure and self-assembly of lipid bilayers, ligand-receptor interactions, membrane permeability, Nernst potential, adsorption isotherms and transport across membrane. Estimation of transport coefficients based on biomolecular interactions. Research-specific case studies incorporating coupled migration through reactive, electrical and heterogeneity considerations.

CLL731 Advanced Transport Phenomena

3 Credits (3-0-0)

Pre-requisite(s): CLL110

Review of fluid kinematics, conservation laws and constitutive equations. Solution methods for equations of change (e.g., unsteady fluid flow in bounded/unbounded geometries). Creeping flow and lubrication approximation. Surface tension driven flows and multiphase flows. Boundary layer theory. Unsteady heat and mass transport. Coupled transport processes-- forced convection heat and mass transport in confined/unconfined flows. Multicomponent energy and mass transport. Turbulence modeling.

CLL732 Advanced Chemical Engineering Thermodynamics

3 Credits (3-0-0)

Pre-requisite(s): CLL121

First and second law of thermodynamics. Application in analysis of energy and efficiency of equipment, flow through equipment. State and behavior of materials, degree of freedom analysis. Material properties as a function of conditions. Relationships between material properties, and changes in material properties. Equilibrium properties of materials: pure materials, and mixtures. A-priori probability postulate, ergodic hypothesis, introduction to microcanonical, canonical and grand canonical ensembles, derivation of physical properties for pure components and mixtures, ideal gas and lattice gas, virial coefficient calculations. Crystal structures, solutions, modeling and analysis of adsorption phenomena, relating them to macroscopic thermodynamics.

CLL733 Industrial Multiphase Reactors

3 Credits (3-0-0)

Pre-requisite(s): CLL122, CLL222

Introduction to advanced reactor analysis tools: RTD theory, RTD based models, axial dispersion, tank-in-series, multizonal models. Hydrodynamics and flow regimes. Transport effects in multiphase reactors, interplay of length and time scales. Process parameters of interest. Effectiveness factors in G/S and L/S systems, including non-isothermal effects. Enhancement factor in G/L systems. Models for non-catalytic heterogeneous reactions. Introduction to multiphase reactors and their applications, classification of multiphase reactors, performance/operating characteristics. Mechanically agitated reactors, bubble column/slurry bubble column reactors, fluidized bed, packed bed, trickle bed reactor reactors. Limitations of models, applications to design of multiphase reactors for specific applications.

CLL734 Process Intensification and Novel Reactors

3 Credits (3-0-0)

Pre-requisite(s): CLL122, CLL222

Introduction to process intensification, possible ways of process intensification and their examples. Introduction to multifunctional reactors/process equipment: reactive distillation, reactor-heat-exchangers. membrane reactors, micro-reactors, structured/monolithic reactors. Intensification of conventional reactors/process equipments, analysis of fluid dynamics and transport effects of intensified reactors. Order of magnitude analysis of reaction rates, heat/mass transfer rates. Flow patterns in intensified reactors. Design and scale of intensified reactors, fabrication issues. Examples of process intensification.

CLL735 Design of Multicomponent Separation Processes

3 Credits (3-0-0)

Pre-requisite(s): CLL352

Overview of multi-component separation. Non-ideal solution and properties, equation of state, vapour liquid equilibrium. Multi component separation: Short cut method, rigorous calculations - sum rate, boiling point and Newton's methods, inside-out method for designing of multi-component distillation, absorption and extraction column/contacting devices. Choice of column: tray, random packing and structured packing. Design of adsorption and ion exchange column. Crystallization. Affinity separation and chromatographic separation. Optimal reflux ratio (recycle stream) - operating expenditure versus capital expenditure for all types of columns and contacting devices.

CLL736 Experimental Characterization of Multiphase Reactors

3 Credits (3-0-0)

Pre-requisite(s): CLL122, CLL222

Analytical techniques: Introduction to various analytical techniques e.g. GC, HPLC, UV Spectroscopy, TGA /DTA, FTIR, MS, GCMS, NMR, TOC, CHONS. Principle of measurement techniques, instruments and procedures. Calibration, data processing, analysis and interpretation. Few working demonstrations.

Catalysis characterization: Introduction to various catalysis preparations and characterization techniques, e.g. porosity, surface area, pore volume and pore size distribution (using BET), XRD, SEM, TEM, NMR, AFM, ESCA. Mossbauer spectroscopy, chemisorption, TPD/TPR.

Flow characterization: Introduction to single/multiphase flows/reactors, role of hydrodynamics. Process parameters of interest, length and time scales, instantaneous vs. time averaged characteristics. Introduction to various advanced intrusive and non-intrusive flow measurement techniques, e.g. miniaturized pressure probes, gamma-ray tomography, densitometry, PIV, RPT, ECT/ERT, high speed photography, tracers and radiotracers.

CLL742 Experimental Characterization of BioMacromolecules

3 Credits (3-0-0)

*Pre-requisite(s): CLL141, CLL271**Overlaps with: PTL705*

Theory and working principles of analytical instruments including high performance liquid chromatography (HPLC), ultra-high performance liquid chromatography (UPLC), capillary electrophoresis (CE), capillary isoelectric focusing (cIEF), gel electrophoresis, circular dichroism (CD) spectroscopy, Fourier transform infrared spectroscopy (FTIR), mass spectroscopy (MS), atomic force microscopy (AFM), scanning electron microscope (SEM), differential scanning calorimetry (DSC), ultraviolet (UV) spectroscopy, surface plasmon resonance (SPR), 2D gel electrophoresis, fluorescence spectroscopy, Zeta-meter, contact angle goniometer, oscillatory drop module (ODM) of goniometer, and quartz crystal microbalance (QCM). Hands-on experience on characterization of proteins. Case studies in biotech industry.

CLL743 Petrochemicals Technology

3 Credits (3-0-0)

Pre-requisite(s): CLL222

Composition of petroleum: laboratory tests, refinery products, characterization of crude oil. Review of petrochemicals sector and Indian petrochemical industries in particular. Feed stocks for petrochemical industries and their sources. Overview of refining processes: catalytic cracking, reforming, delayed coking, Hydrogenation and Hydrocracking, Isomerization, Alkylation and polymerization, purification of gases, separation of aromatics by various techniques. Petrochemicals from methane, ethane, ethylene, acetylene, C3/C4 and higher hydrocarbons. Synthesis gas chemicals. Polymers from Olefins. Synthetic fibers, rubber, plastics and synthetic detergents. Energy conservation in petrochemical Industries. Pollution control in petrochemical industries. New trends in petrochemical industry. Planning and commissioning of a petrochemicals complex.

CLL760 Crystal Engineering and Design

3 Credits (3-0-0)

Pre-requisite(s): CLL110, CLL121

Fundamental aspects of crystal growth – role of controlling parameters; Intermolecular interaction between solution species and surface of crystals; Nucleation and growth mechanism, kinetics and limitations; Spinal decomposition– mean-field and non-linear models; Kinetics of frontal growth; Models for 2d and 3d growth; Various analytical tools to characterize the phenomena of crystal formation and growth – static and dynamic light scattering; scanning probe microscope, optical microscopy, time-resolved techniques for crystallization kinetics; Modelling of crystallization kinetics; Industrial relevance and design aspects; Real-life problems in crystal engineering.

CLL761 Chemical Engineering Mathematics

3 Credits (3-0-0)

Pre-requisite(s): MTL101, CLL110

Classification, estimation and propagation of errors. Presentation of data. Statistical methods: sample and population distributions, testing of hypothesis, analysis of variance.

Vector spaces, basis, matrices and differential operators. Eigen values, vectors and functions. Solvability conditions for linear equations. Frobenius method for ordinary differential equations. Sturm-Liouville Theorem: Separation of variables and Fourier transform. Green's function and its applications.

CLL762 Advanced Computational Techniques in Chemical Engineering

3 Credits (2-0-2)

*Pre-requisite(s): CLL113**Overlaps with: APL703*

Introduction to models in Chemical Engineering. Formulation of

problems leading to ODEs of initial value types. Stability and stiffness of matrices. Solution of stiff problems like Rober's problem in autocatalytic reactions by Gear's algorithm. Formulation of problems leading to steady state ODEs of boundary value types. Different weighted residual methods to solve BVPs. Orthogonal collocation and Galerkin finite element method. Application to reaction diffusion in porous catalysts pellets under non-isothermal conditions, calculation of effectiveness factor. Moving boundary problems. Transient problems leading to PDEs. Examples in heat and mass transfer and their numerical solution: orthogonal collocation. Monte Carlo method and its applications. Introduction to LBM method to solve fluid flow problems.

CLL766 Interfacial Engineering

3 Credits (3-0-0)

Pre-requisite(s): CLL110, CLL121

Concept and definition of interface. Physical surfaces. Surface chemistry and physics of colloids, thin films, dispersions, emulsions, foams, polyaphrons. Interfacial processes such as crystallization, epitaxy, froth flotation, adsorption, adsorptive bubble separation, catalysis, reaction-injection moulding, microencapsulation. Industrial aspects of interfacial engineering.

CLL767 Structures and Properties of Polymers

3 Credits (3-0-0)

*Pre-requisite(s): CLL141**Overlaps with: PTL703, PTL701, TTL712*

Overview of polymer science and engineering with reference to polymer-solution. Chain dimension: variation of chain dimension with concentration, solvency etc., scaling theory. Molecular weight distribution and its effect on properties of polymer solution. Polymer solution thermodynamics: Flory-Huggins equation and its development, phase separation. Polymer in good, theta and poor solution. Colligative properties of polymer solution. Flow phenomena in polymeric liquids. Material functions for polymeric liquids. General linear viscoelastic fluid: Rouse dynamics, Zimm dynamics. Hyper branched polymer and its physical properties in various solutions. Dynamics of entangled polymers - polymer melt, chain reptation, tube model, chain length fluctuations. Convective constraint release.

CLL768 Fundamentals of Computational Fluid Dynamics

3 Credits (2-0-2)

*Pre-requisite(s): CLL113, CLL110**Overlaps with: AML410, MEL807*

Review of basic fluid mechanics and the governing (Navier-Stokes) equations. Techniques for solution of PDEs – finite difference method, finite element method and finite volume method. Finite volume (FV) method in one-dimension. Differencing schemes. Steady and unsteady calculations. Boundary conditions. FV discretization in two and three dimensions. SIMPLE algorithm and flow field calculations, variants of SIMPLE. Turbulence and turbulence modeling: illustrative flow computations. Commercial software - grid generation, flow prediction and post-processing.

CLL769 Applications of Computational Fluid Dynamics

3 Credits (2-0-2)

*Pre-requisite(s): CLL110**Overlaps with: APL410, APL720, MCL813*

Introduction and review of fundamentals of CFD. Numerical simulations of turbulent flows: RANS approach; Introduction to Large Eddy Simulation (LES) and Direct Numerical Simulations (DNS). Numerical simulations of multiphase flows. Two-fluid and Multi-fluid Euler-methods; Discrete particle (Euler-Lagrange) methods; Interface tracking/capturing methods (Volume of Fluid Methods) (Volume of Fluid Method). Applications of these Methods to simulate dispersed gas-liquid, gas-solid flows in bubble columns, fluidized beds, packed beds, etc. Numerical simulations of fluid flows with heat transfer. Numerical simulations of reactive flows.

CLD771 Minor Project

3 Credits (0-0-6)

Literature survey, Writing technical report, Planning and execution of the project work within the stipulated time frame.

CLL771 Introduction to Complex Fluids

3 Credits (3-0-0)

Overview of complex fluids: forces, energies, responses and timescales in complex fluids. Types of complex fluids: colloidal dispersions, polymers, gels, liquid crystals, polymer crystals, granular materials, biomolecules. Characterization of structure-property relationships in complex fluids.

CLL772 Transport Phenomena in Complex Fluids

3 Credits (3-0-0)

Pre-requisite(s): CLL110

Classification of fluids under time dependent, time independent and viscoelastic behaviors. Particle level responses: microstructural origins of deformation. Linear and non-linear viscoelasticity. Transport processes in a variety of self-assembling fluids, including surfactant micelles, nano-emulsions, gels, liquid crystalline polymers. Dynamics of rod-like polymers. Static and viscoelastic properties of interfaces. Rheometry and constitutive modeling. Heat transfer in complex fluids: boundary layers. Mixing equipment and its selection.

CLL773 Thermodynamics of Complex Fluids

3 Credits (3-0-0)

Pre-requisite(s): CLL121

Overlaps with: PYL202

Intermolecular forces. Statistical mechanical approach to thermodynamic potentials. Characterization of free energy curves. Entropically driven phase separation, nucleation and spontaneous phase separations in complex fluids. Characterization of structures: Minkowski functionals. Phase separation in confinement. Mean field theories for phase transition, their break-down, introduction to field theory. Thermodynamics of colloidal systems and polymers.

CLL774 Simulation Techniques for Complex Fluids

3 Credits (3-0-0)

Pre-requisite(s): CLL113

Overlaps with: MCL315

Simulation techniques: Molecular Dynamics, Brownian Dynamics, Monte-Carlo, Discrete Element Method and Lattice Boltzmann Simulations. Force fields and interactions. Statistical measures and trajectory analysis to determine structure (e.g., radial distribution function) and properties (e.g., self-diffusivity, shear-dependent viscosity) of complex fluids.

CLL775 Polymerization Process Modeling

3 Credits (3-0-0)

Pre-requisite(s): CLL122

Overlaps with: PTL701

Modeling of step-growth, chain-growth and non-linear polymerization in homogeneous and heterogeneous conditions. Design of CSTR, plug flow, batch and multistep reactors for different polymerization reactions. Control and optimization of polymer reactors, Mathematical modeling and analysis of polymer processing units.

CLL776 Granular Materials

3 Credits (3-0-0)

Pre-requisite(s): CLL331

Continuum mechanics, statistical physics and rigid body dynamics approaches to understand microscopic and macroscopic behavior of granular materials. Constitutive modeling and rheology of granular materials. Advanced simulation techniques for particle dynamics. Design of flow and handling systems for granular materials.

CLL777 Complex Fluids Technology

3 Credits (3-0-0)

Pre-requisite(s): CLL141

An overview of various technologies based on complex fluids and relate them to fundamental principles of thermodynamics and transport phenomena in complex fluids, e.g., how to manipulate micro-structures and their environment to achieve new products with desired properties. Case studies involving assembly, stability and applications of colloids, emulsions, suspensions, polymer melts and granular materials.

CLL778 Interfacial Behaviour and Transport of Biomolecules

3 Credits (3-0-0)

Pre-requisite(s): CLL110

Overlaps with: CYL669, SBL705, SBV885

Structure of biomacromolecules. Attributes of biomacromolecules: size, charge, hydrophobicity. Characteristics of surface and interfaces: roughness, charge, hydrophobicity. Interactions between biomacromolecules and interfaces: adsorption, specific binding. Aggregation of proteins, modeling of the underlying phenomena. Elasticity of adsorbed macro-molecules at interfaces. Equilibrium and transient description of transport of biomolecules through intra- and extracellular space. Governing equations applied to biological systems: conservation laws, flux equations, Fickian and non-Fickian diffusion, diffusion with reaction/ binding, electrochemical transport. Constitutive laws and solution methods applied to biological systems. Adsorption isotherms and transport across membrane.

CLL779 Molecular Biotechnology and in-vitro Diagnostics

3 Credits (3-0-0)

Introduction to the cellular structure and function of biomolecules, theory and experimental characterization of commonly-used laboratory techniques in molecular diagnostic protocols. Identification of the important parameters such as sensitivity, specificity, LOD etc. in the design of a quality system for molecular analyses. Highly sensitive reporter technologies and applications, technologies providing highly dense and bioactive solid phases, novel bioaffinity binders, heterogeneous and homogenous assay concepts, and multiplexed bioassays.

CLL780 Bioprocessing and Bioseparations

3 Credits (3-0-0)

Pre-requisite(s): CLL271

Overlaps with: BEL703, BEL820

Introduction to the different unit operations utilized in production of biotech drugs in the areas of upstream processing, harvest, and downstream processing. Introduction to analytical methods used for characterization of biotech products and processes (high performance liquid chromatography, mass spectrophotometry, capillary electrophoresis, near infrared spectroscopy, UV spectroscopy). Optimization of biotech processes - unit operation specific optimization vs. process optimization, process intensification, statistical data analysis. Scale-up of different unit operations utilized in bioprocessing: procedures, issues that frequently occur and possible solutions.

Good Manufacturing Practices (GMP): need, principles and key practical issues. Process validation: basics, planning and implementation. Industrial case studies in bioprocessing. Current topics in bioprocessing and bioseparations: Quality by Design and Process Analytical Technology.

CLD781 Major Project Part-I

8 Credits (0-0-16)

Literature survey, Writing technical report, Planning and execution of the project work within the stipulated time frame.

CLL781 Process Operations Scheduling

3 Credits (3-0-0)

Introduction to enterprise-wide supply-chain optimization. Decision

making for planning and scheduling. Classification of scheduling formulations: various storage policies, network representations, time representations. Short-term scheduling of batch processes: discrete-time and continuous-time based models. Cyclic and short-term scheduling of continuous processes. Solution of resulting models with industrial applications using GAMS modeling language.

CLD782 Major Project Part-II

12 Credits (0-0-24)

Pre-requisite(s): CLD781

Formulation of the problem, literature survey, design and fabrication of the experimental setup, study of experimental techniques in the case of experimental projects, formulation of equations and analytical/numerical solution in case of modeling projects, development of software, analysis and interpretation of results, writing technical report, presentation of results and scientific reporting in form or thesis and presentation.

CLL782 Process Optimization

3 Credits (3-0-0)

Pre-requisite(s): CLL222, CLL352

Overlaps with: MTL103, MTL625, MTL704, APL771, MCL742

Introduction to optimization and applications; classification (LP, NLP, MILP, MINLP), convexity, unimodal vs multimodal. Single variable and multivariable unconstrained optimization methods. Linear programming, branch and bound method for MILP. Constrained optimization: nonlinear programming. Necessary and sufficient conditions of optimality. Quadratic programming. Case studies from chemical industry.

CLL783 Advanced Process Control

3 Credits (3-0-0)

Pre-requisite(s): CLL261

Overlaps with: ELL325, ELL723, BBL444

State-space models. Distributed parameter models. Feedforward control. Ratio control. Dead-time compensation. Relative gain array. Z-transforms and digital control. Internal model control. State estimation and process identification. Adaptive control. Non-linear control. Model-based control structures. Synthesis of control systems with case studies. Intelligent control, model predictive control.

CLL784 Process Modeling and Simulation

3 Credits (3-0-0)

Pre-requisite(s): CLL222, CLL352

Introduction to modeling, physical and mathematical models, modeling individual units vs. process. Role of simulation and simulators. Sequential and modular approaches to flowsheet simulation: equation solving approach. Decomposition of networks: tearing algorithms, convergence promotion.

Specific purpose simulation. Dynamic simulation. Case studies using commercial or open source simulation packages.

CLL785 Evolutionary Optimization

3 Credits (3-0-0)

Pre-requisite(s): CLL222

Overlaps with: MTL720

Traditional vs. nontraditional optimization techniques. Population based search algorithms. Evolutionary strategies. Simulated annealing. Genetic algorithms. Differential evolution. Different strategies of differential evolution. Memetic algorithms. Scatter, Tabu search. Ant-colony optimization. Particle swarm optimization. Self-organizing migrating algorithm. Neural networks. Quantum computing. DNA computing. Multi-objective optimization. Industrial applications.

CLL786 Fine Chemicals Technology

3 Credits (3-0-0)

Pre-requisite(s): CLL222

Introduction to fine and high value chemicals. Historical

perspectives. Synthesis methods from chemical (petrochemicals and natural products) and biotechnology routes (enzymatic methods, fermentation and cell culture technology). Extraction of fine chemicals from microorganisms, plant sources and animal sources. Chromatographic separations. Reactor technology for fine chemicals. Scale-up and scale-out of reactors. Microreactor technology and process intensification. Novel high value chemicals for adhesives, electronic materials, food additives, specialty polymers, flavours and fragrances.

CLL787 Statistical Methods for Chemical Engineering

3 Credits (3-0-0)

Revisit of probability and random variables (rv), expectation operator, moments of distributions; Discrete rv and probability distributions: Bernoulli, Poisson, Geometric and Multinomial distributions; Continuous rv and distributions: Gaussian, Student's- t, Chi Squared, F; Central limit theorem, Estimation: Unbiased estimator, Variance, standard error and mean square error of the estimator; Method of point estimation: Method of moments, maximum likelihood and Bayesian estimation; Interval estimation: Chebyshev's inequality; Multivariate Gaussian distribution; Multivariate hypothesis testing: testing of mean with variance known and unknown and two sample cases and their confidence intervals, Tests on population proportion, paired t- tests, type II error; Simple and multiple linear regression, significance of regression, confidence interval for parameters, confidence interval for mean response and prediction interval for future observation, properties of least square estimators-Gauss-Markov theorem, Model adequacy test-residual analysis, normality test and correlation coefficient, influential observations, Other regression models: polynomial regression, weighted least squares regression, total least squares regression, stepwise Regression, robust regression, ridge, quantile regression, least angle regression, lasso regression, elastic net regression, concept of regularization, multicollinearity; Application of process examples- Tennessee-Eastman process case study; Gross errors and random errors, Statistical basis of data reconciliation, data reconciliation of linear systems with all variables measured, with measured and unmeasured variables, Concept of redundancy and observability of process variables using graphs, estimation of measurement covariance, bilinear data reconciliation problems-Crowe's method, Simpson's method, process examples-binary distillation column, splitter, mixer, separator; Linear dynamic data reconciliation: Optimal state estimation using Kalman filter; Glimpse of nonlinear data reconciliation process; Introduction to gross error detection; Statistical tests for gross error detection: global test, measurement test, nodal test, generalized likelihood ratio test, principal component tests, type I and type II errors; detectability and identifiability of gross errors; Application of process examples- mass flow networks; Introduction to software packages: MATLAB and R; Process applications and case studies: Continuous Stirred Tank Reactor example, process flow networks and Tennessee-Eastman process case study.

CLL788 Process Data Analytics

3 Credits (3-0-0)

Process data pre-processing and handling: data visualization and transformation; quick revisit to regression modeling. Dimensionality reduction and latent variable models with applications to fault detection and inferential modeling of processes: Principal Component Analysis (PCA), factor analysis, canonical correlation analysis, partial least squares; Classification and clustering methods with applications to process mode diagnosis: k-nearest neighbor, naive Bayes, linear discriminants, support vector machines, decision trees and forests, k-means, fuzzy c-means, possibilistic c-means, hierarchical clustering methods, mixture models; Nonlinear approaches: Kernel methods-kernel PCA, kernel SVM, neural nets-feed forward networks, Gaussian process; Entropy and its applications to redundant variable isolation: Shannon entropy, cross entropy, joint and conditional entropy, KL-divergence, mutual information; Model learning approaches: Maximum likelihood, maximum a posteriori, Bayesian approaches; Expectation-Maximization, back propagation, ensemble learning; Model assessment and validation: BIC, kfold cross validation, model averaging; Switching process systems modeling: Markov models,

hidden Markov models (HMM); Estimation and inference of dynamical systems: Kalman filter and smoother, particle filters; Introduction to software packages: PYTHON, MATLAB and R; Process applications and case studies: Continuous Stirred Tank Reactor example and Tennessee-Eastman process case study.

CLL789 Applied Time Series Analysis for Chemical Engineering

3 Credits (3-0-0)

Overlaps with: ELL319, ELL720

Models for Discrete-Time Linear Time Invariant (LTI) Systems: Models for Discrete-Time LTI Systems, LTI system in frequency domain, Sampling and discretization of process data, Time domain analysis of process data, A quick introduction into time series modelling of process data; LTI system in frequency domain: Frequency response function; Z-transforms, initial final value theorems, Properties of z-Transforms, Transfer function and its properties, Empirical transfer function; Sampling and discretization of process data: Approximate and exact discretization, Zero order hold, Single rate vs. Multi-rate systems, State space approach for discretization, Sampling and reconstruction, Sampling theorem; Time domain analysis of process data: Auto covariance function, Auto correlation function, White noise process, Cross covariance function, Partial auto correlation function, Partial cross correlation function, A quick introduction into time series modelling of process data: Auto Regressive, Moving Average, Auto Regressive Exogeneous family, Auto Regressive Moving Average Exogeneous family, Box-Jenkins, Output-error models; Frequency domain analysis of process data: Fourier Analysis and Spectral Analysis: Fourier series, Power spectrum, Discrete time Fourier transform, Discrete Fourier transform, Spectrum, spectral density and spectral envelope; Introduction to estimation and inference of linear process dynamical systems with Gaussian noise: Kalman filter; Introduction to estimation and inference of nonlinear process dynamical systems with Gaussian noise: Extended Kalman filter, Unscented Kalman filter, Ensemble Kalman filter; Introduction to estimation and inference of nonlinear process dynamical systems with non-Gaussian noise: Particle filter; Process applications and case studies: Continuous Stirred Tank Reactor example, Quadruple tank system and Tennessee-Eastman process case study. Signal processing toolbox and system identification toolbox in MATLAB.

CLL791 Chemical Product and Process Integration

3 Credits (3-0-0)

Pre-requisite(s): CLL371

The course will be a structured project based course with initial exposure to industrial processes of understanding Voice of Customers, identifying design specifications, scoping the technology and product landscape and deciding on the technology strategy. Technical and economic feasibility analysis as well as scale-up and manufacturing concerns will also be discussed. Each group will identify a specific product or process of interest and work through these considerations as well as integrate thermodynamics, transport principles, fluid mechanics and reactor design understanding to design the product or process chosen.

CLL792 Chemical Product Development and Commercialization

3 Credits (3-0-0)

Pre-requisite(s): CLL110

Overlaps with: MTL766, MAL719, SML802

Design of experiments - factors, responses, main effects, interactions, different kinds of designs - screening vs. high resolution. Statistical data analysis - applied probability, sampling, estimation, hypothesis testing, linear regression, analysis of variance, types of data plots. Technology transfer of processes - need of technology transfer, key attributes, key challenges, solutions to various issues. Intellectual property management - intellectual property rights, IPR laws, patents, trademarks, designs, copyrights, licensing, IP management. Commercialization

of technologies - invention, product development, technical and market feasibility analysis, intellectual property acquisition.

CLL793 Membrane Science and Engineering

3 Credits (3-0-0)

Pre-requisite(s): CLL110, CLL252

Introduction to membrane separation processes, their classification, and applications. General transport theories including theory of irreversible thermodynamics for multicomponent systems. Membrane preparation techniques. Design and analysis and industrial application of various membrane processes such as reverse osmosis, ultra filtration, electrodialysis, dialysis, liquid membrane separation, gas permeation and pervaporation.

CLL794 Petroleum Refinery Engineering

3 Credits (3-0-0)

Pre-requisite(s): CLL222, CLL352

Composition of petroleum, laboratory tests, refinery products, characterization of crude oil. Design of crude oil distillation column. Catalytic cracking, catalytic reforming, delayed coking, furnace design, hydrogenation and hydrocracking, isomerization, alkylation and polymerization. Lube oil manufacturing. Energy conservation in petroleum refineries. New trends in petroleum refinery operations. Pyrolysis of naphtha and light hydrocarbons.

CLV796 Current Topics in Chemical Engineering

1 Credit (1-0-0)

As per declaration of instructor(s).

CLV797 Recent Advances in Chemical Engineering

2 Credits (2-0-0)

Pre-requisite(s): To be declared by Instructor

As per declaration of instructor(s).

CLL798 Selected Topics in Chemical Engineering-I

3 Credits (3-0-0)

Pre-requisite(s): To be declared by Instructor

As per declaration of instructor(s).

CLL799 Selected Topics in Chemical Engineering-II

3 Credits (3-0-0)

Pre-requisite(s): To be declared by Instructor

As per declaration of instructor(s).

CLD880 Minor Project

4 Credits (0-0-8)

CLD881 Major Project Part-I

8 Credits (0-0-16)

CLD882 Major Project Part-II

12 Credits (0-0-24)

Pre-requisite(s): CLD881

Formulation of the problem, literature survey, design and fabrication of the experimental setup, study of experimental techniques in the case of experimental projects, formulation of equations and analytical/numerical solution in case of modeling projects, development of software, analysis and interpretation of results, writing technical report, presentation of results and scientific reporting in form or thesis and presentation.

CLD895 MS Research Project

36 Credits (0-0-72)

Department of Chemistry

CML101 Introduction to Chemistry

4 Credits (3-1-0)

Basics of rate laws; Complex reactions: consecutive and parallel reactions; Temperature dependence of reaction rates; Reaction mechanisms: steady-state approximation, pre-equilibria, unimolecular reactions; Catalysis; Atomic structure: Schrödinger equation, the hydrogen atom; The chemical bond: simplest molecules H_2^+ and H_2 ; Vibration of diatomics: harmonic oscillator and Morse potential Stability of organometallic compounds; Metal carbonyls: structure and bonding; Important reactions of organometallic compounds; Homogeneous catalysis; Applications of crystal field theory; An overview of metals in biology; Functions of metalloproteins R/S-Nomenclature; Projection formulas; MO approaches for the stereochemical outcome of the reactions; Determination of reaction mechanism; Kinetic versus thermodynamic control of the reaction; Trapping of reactive intermediates; Spectroscopic methods of structure determination.

CMP100 Chemistry Laboratory

2 Credits (0-0-4)

Experiments involve the following: Titrations, Surface Tension and Viscosity, Potentiometry, Conductometry, Preparation of metal complexes and important organic compounds, Kinetics, Chromatography, Qualitative and quantitative estimation of organic compounds.

CML102 Chemical Synthesis of Functional Materials

3 Credits (3-0-0)

Chemical approaches to the synthesis of functional materials – the design of materials targeting important properties by 'bottom-up' processes that manipulate primary chemical bonds.

Fundamental chemistry principles involved in materials design through synthesis – process methodologies such as self-assembly, sol-gel reactions, synthesis of nanomaterials, etc.

CML103 Applied Chemistry - Chemistry at Interfaces

3 Credits (3-0-0)

Unit processes in organic synthesis. Laboratory vs. industrial synthesis. Role of medium in directing synthetic outcomes, organized media. Natural and synthetic constrained systems (inorganic and organic) for control of reactivity in organic reactions. Phase transfer catalysts, polymer and supported reagents for control of reactions. Green Chemistry. Heterogeneous and homogeneous catalysis, surface chemistry, kinetics of catalyzed reactions. Industrial catalysis.

CML511 Quantum Chemistry

3 Credits (3-0-0)

Basic concepts and postulates of quantum mechanics, Hydrogen atom, Quantization of angular momentum, Many electron atoms, Variation theorem, Perturbation theory, Molecular orbital and valence bond theories, Introductory treatment of semi-empirical and ab initio calculations on molecular systems, Density functional theory.

CMP511 Laboratory-I

2 Credits (0-0-4)

Experiments highlighting the principles of thermodynamics and chemical equilibrium, electrochemistry, chemical kinetics, spectroscopy, and computer simulations. Examples include: Thermodynamics of micellization, Synthesis, stabilization, and spectroscopy of nanoparticles, Steady-state and time resolved fluorescence, Cyclic and linear sweep voltammetry, Electronic structure calculations, etc.

CMP512 Laboratory-II

2 Credits (0-0-4)

Selected experiments to develop the synthetic, purification, and analytical/characterization skills in different areas of inorganic chemistry, such as, coordination, organometallic, bioinorganic chemistry, and so forth.

CML512 Stereochemistry & Organic Reaction Mechanisms

3 Credits (3-0-0)

Stereochemistry of acyclic and cyclic compounds including chiral molecules without a chiral centre, Reaction mechanisms (polar and free radical) with stereochemical considerations, Reactive intermediates: generation, structure, and reactivity.

CML513 Photochemistry & Pericyclic Reactions

3 Credits (3-0-0)

Pericyclic reaction, Introduction and classification, Theory of pericyclic reactions: correlation diagrams, FMO, and PMO methods, Cycloadditions reactions, Molecular rearrangements (pericyclic and non-pericyclic), Photochemistry: basics and mechanistic principles, Photochemical rearrangements, Reactivity of simple chromophores.

CML514 Main Group Chemistry

3 Credits (3-0-0)

General properties of p block elements, bonding, historical landmarks, and periodic properties, Introduction to group theory, Chemistry of alkali and alkaline earth metals, Chemistry of group 13, 14, 15, and 16 elements, Halogen chemistry, Chemistry of rare gases.

CML515 Instrumental Methods of Analysis

3 Credits (3-0-0)

Measurement basics and data analysis, Introduction to spectrometric methods and components of optical instruments, Atomic absorption, fluorescence, emission, mass, and X-ray spectrometry, Introduction to and applications of uv-vis molecular absorption, luminescence, infrared, Raman, nuclear magnetic resonance, and mass spectroscopy/ spectrometry, Introduction to electroanalytical methods: potentiometry, coulometry, and voltammetry, Introduction to chromatographic separation: gas, high-performance liquid, supercritical fluid, and capillary electrophoresis chromatography, Introduction to thermal methods of analysis.

CML521 Molecular Thermodynamics

3 Credits (3-0-0)

Basics concepts, Review of first, second, and third laws of thermodynamics, Gibb's free energy, Extra work, Chemical potential, Ideal and non ideal solution, Phase rule, Phase diagram, Solutions, Chemical equilibrium, Postulates of statistical thermodynamics, Ensembles, Monoatomic and polyatomic ideal gases, Molar heat capacities, Classical statistical mechanics.

CMP521 Laboratory-III

2 Credits (0-0-4)

Basic laboratory techniques to synthesize, purify, and characterize small organic molecules by analytical and spectroscopic methods.

CMP522 Laboratory-IV

2 Credits (0-0-4)

Determination of enzyme activity in biological samples, Protein purification and characterization, Microbial growth experiments, DNA and RNA isolation, Gel electrophoresis.

CML522 Chemical Dynamics & Surface Chemistry

3 Credits (3-0-0)

Kinetics of simple and complex reactions, Transport properties, Theories of reaction rates and dynamics of gas and liquid phase reactions, Experimental techniques to study fast reactions, Photochemical reactions, Surface phenomena and physical methods for studying surfaces, Heterogeneous and homogeneous catalysis.

CML523 Organic Synthesis

3 Credits (3-0-0)

Formation of carbon-carbon bonds including organometallic reactions,

Synthetic applications of organoboranes and organosilanes, Reactions at unactivated C-H bonds, Oxidations, Reductions, Newer Reagents, Design of organic synthesis, Retrosynthetic analysis, Selectivity in organic synthesis, Protection and deprotection of functional groups, Multistep synthesis of some representative molecules.

CML524 Transition and Inner Transition Metal Chemistry 3 Credits (3-0-0)

Introduction to coordination chemistry, Crystal field theory, Ligand field theory, Molecular orbital theory, Magnetic and spectral characteristics of inner transition metal complexes, Substitution, Electron transfer and photochemical reactions of transition metal complexes, Physical, spectroscopic, and electrochemical methods used in the study of transition metal complexes, Metal-metal bonded compounds and transition metal cluster compounds, Uses of lanthanide complexes: as shift reagents, as strong magnets, and in fluorescence, Bioinorganic chemistry: introduction, Bioinorganic chemistry of iron: hemoglobin, myoglobin, cytochromes, Bioinorganic chemistry of zinc, cobalt, and copper.

CML525 Basic Organometallic Chemistry 3 Credits (3-0-0)

Organometallic chemistry of main group, transition, and inner transition metals. Synthesis and applications of BuLi, Grignard, organoaluminum, and organozinc reagents, 18 electron rule, Metal carbonyls: bonding and infrared spectra, phosphines and NHC's, Alkenes and alkynes, carbenes and carbynes (Fisher and Schrock), Hapto ligands with hapticity from 2-8, Oxidative addition and reductive elimination, 1,1 and 1,2-migratory insertions and beta hydrogen elimination, Mechanism of substitution reactions, Fluxionality and hapticity change, Organometallic clusters, C-H activation: agostic and anagostic interactions, Homogeneous catalysis: hydrogenation, hydroformylation, methanol to acetic acid processes, and Wacker oxidation, Introduction to cross coupling and olefin metathesis reactions, Olefin oligomerization and polymerization.

CML526 Structure & Function of Cellular Biomolecules 3 Credits (3-0-0)

Prokaryotic and eukaryotic cells, Structure and function of proteins, carbohydrates, nucleic acids, and lipids. Biological membranes, Enzymes: classification, kinetics, mechanism, and applications. Basic concepts of microbial culture, growth, and physiology.

CMD631 Project Part-I 6 Credits (0-0-12)

CML631 Molecular Biochemistry 3 Credits (3-0-0)

Central dogma, DNA replication and repair, Transcription, Translation, Recombinant DNA technology, Basic concept of metabolism: glycolysis, TCA cycle, β -oxidation, Amino acid transamination and urea cycle.

CMD641 Project Part-II 10 Credits (0-0-20)

CML661 Solid State Chemistry 3 Credits (3-0-0)

Crystal chemistry, Bonding in solids, Defects and non-stoichiometry, A range of synthetic and analytical techniques to prepare and characterize solids, Electronic, magnetic, and superconducting properties, Optical properties which include: luminescence and lasers, nanostructures and low dimensional properties, etc.

CML662 Statistical Mechanics & Molecular Simulation Methods 3 Credits (3-0-0)

Micro- and macroscopic state of a classical system, Phase space, Ergodicity and mixing in phase space, Theory of ensembles, Classical

fluids, Phase transitions and relaxation phenomena, Monte Carlo, molecular dynamics, and Brownian dynamics, Computer simulations, Brownian motion, Langevin equation, Elucidation of structural, dynamic, and thermodynamic properties of complex fluids and soft matter.

CML663 Selected Topics in Spectroscopy 3 Credits (3-0-0)

Franck-Condon principle, Fermi Golden rule, Normal mode analysis, Multi-photon spectroscopy, Molecular beam techniques, Non-linear laser spectroscopy, Two-level systems, Precession, Rabi frequency, Nutation, Block equations, Multi-dimensional NMR techniques.

CML664 Group Theory & Spectroscopy 3 Credits (3-0-0)

Symmetry operations, Review of point and space groups, Applications of group theoretical techniques in spectroscopy, Chemical bonding, Crystallography, Theoretical treatment of rotational, vibrational, and electronic spectroscopy, Magnetic spectroscopy.

CML665 Biophysical Chemistry 3 Credits (3-0-0)

Structure and conformations of proteins, nucleic acids and other biological polymers, Techniques for the study of biological structure and function, Configurational statistics and conformational transitions, Thermodynamics and kinetics of ligand interactions, Regulation of biological activity, Bioinformatics: Genomics and proteomics.

CML671 Supramolecular Chemistry 3 Credits (3-0-0)

Non-covalent associations, Molecular recognition, Design and applications of molecular hosts: crown compounds, cyclophanes, cyclodextrins, etc., Nano technology, Molecular clefts, tweezers, and devices, Self assembly and replication.

CML672 Recent Trends in Organic Chemistry 3 Credits (3-0-0)

Recent advances in organic synthesis, spectroscopy, and reaction mechanisms.

CML673 Bio-organic and Medicinal Chemistry 3 Credits (3-0-0)

Bio-organic: Amino acids, polypeptides, and enzyme models, Medicinal: definitions and classifications, Pharmaceutical, pharmacokinetic, and pharmacodynamic phases, Drug-receptor interactions, Intra- and intermolecular forces, Solvent effects, Ligand binding, Docking and design, Drug metabolism.

CML674 Physical Methods of Structure Determination of Organic Compounds 3 Credits (3-0-0)

Applications of UV, IR, NMR, and mass spectral methods in structure determination of organic compounds.

CML675/CML740 Chemistry of Heterocyclic Compounds 3 Credits (3-0-0)

Chemistry of heterocyclic compounds containing one, two, and three heteroatoms, Total synthesis of representative natural products.

CML681 Physical Methods in Inorganic Chemistry 3 Credits (3-0-0)

Use of NMR spectroscopy for structural elucidation of simple inorganic and organometallic compounds using chemical shifts and hetero-nuclear coupling constants, Relaxation phenomena in inorganic compounds, Double resonance technique and its applications, EPR spectroscopy for the identification of inorganic radicals, Introduction to Mossbauer spectroscopy, Factors influencing chemical shifts and quadrupolar splitting, Structural information: X-ray diffraction methods (powder and single crystal), Finger printing of solids from powder data and determination of crystal structures by Rietveld analysis and single crystal studies.

CML682 Inorganic Polymers

3 Credits (3-0-0)

Homo and heterocatenated inorganic polymers: general introduction, Polyphosphazenes: synthetic routes and bonding features, Polymerization of organo/organometallic substituted phosphazenes and their applications, Polysilanes: synthesis and characterization of polysilanes, unique electronic and optical properties and its applications, Polysiloxanes: precursors used in synthesis of polysiloxanes via anionic and cationic polymerization methods, properties and environmental aspects, Polysiloles and their comparison with polythiophenes, Introduction to organometallic polymers: synthesis of poly(ferrocenylsilane)s and their applications. Catalytic methods for homo and hetero-catenated polymers, Characterization methods (spectroscopy, gel permeation chromatography, differential scanning calorimetry)

CML683 Applied Organometallic Chemistry

3 Credits (3-0-0)

Introduction to homogeneous catalysis, TON and TOF, Some aspects of commonly used ligands in homogeneous catalysis, such as, CO, amines, phosphines, NHC's, alkenes, alkynes, carbenes, carbynes, etc., Recent developments in hydrogenation and hydroformylation and their asymmetric variations using OM catalysts, Wacker oxidation, Monsanto and Cativa processes, Olefin and alkyne trimerization and oligomerization, Olefin polymerization using Ziegler-Natta, Titanium group metallocenes, Post metallocene late TM catalysts and FI catalysts, Olefin and alkyne metathesis, Grubbs I, II, and III, Schrock, and Schrock-Hoveyda catalysts, Types of metathesis such as RCM, ROM, ROMP, ADMET, and EM. Applications in industry, Palladium and nickel catalyzed cross coupling reactions such as Suzuki, Heck, Sonogashira, Stille, Negishi, Hiyama, Buchwald-Hartwig, decarboxylative cross coupling, and alpha arylation of carbonyls, Fischer Tropsch Process, C-H activation of alkyls and aryls using transition metal complexes, Organometallic polymers, Bio-organometallic chemistry: Vitamin B-12, Planar chirality of metal sandwich compounds and their applications in industry (e.g. Josiphos catalyst), Ferrocene based drugs, Sustainable catalysis for pharmaceuticals and industry using organometallics.

CML684 Bio-Inorganic Chemistry

3 Credits (3-0-0)

Introduction of bio-inorganic chemistry, General properties of biological molecules, Physical methods in bio-inorganic chemistry, Binding of metal ions and complexes to biomolecule active centers, Synthesis and reactivity of active sites, Atom and group transfer chemistry, Electron transfer in proteins, Frontiers of bio-inorganic chemistry: some topics of current research interest.

CML691 Microbial Biochemistry

3 Credits (3-0-0)

Microscopic examination of microorganisms, classification, morphology and fine structure of microbial cells, cultivation, reproduction and growth, pure culture techniques, Basic microbial metabolisms, Concepts of their genetics: transformation, transduction, and conjugation, Important microorganisms and enzymes.

CML692 Food Chemistry and Biochemistry

3 Credits (3-0-0)

Carbohydrates: structure and functional properties of mono-oligo-polysaccharides including starch, cellulose, pectic substances, and dietary fibers, Essential amino acids, proteins, and lipids in food and their impact on functional properties, vitamins and minerals, Food flavours: terpenes, esters, ketones, and quinines; Food additives, Bioactive constituents in food: isoflavones, phenol, and glycosides; Enzymes: enzymatic and non-enzymatic browning, enzymes in food processing, oxidative enzymes, Food biochemistry: balanced diet, PER, anti-nutrients and toxins, nutrition deficiency diseases.

CML693/ CML739 Applied Biocatalysis

3 Credits (3-0-0)

Introduction to enzymes and enzyme catalysed reactions, Classification and mechanism of reaction, Purification and characterization of enzymes, Michaelis-Menten kinetics, Industrial enzymes, Applications of enzymes in diagnostics, analysis, biosensors, and other industrial processes and bio-transformations, Enzyme structure determination, stability, and stabilisation, Enzyme immobilization and concept of enzyme engineering, Nanobiocatalysis.

CML696 Physical Organic Chemistry

3 Credits (3-0-0)

Overlap with: CML743

Introduction to Molecular Orbital theory, frontier Orbitals and orbital mixing; Details of Reactive intermediates; Correlation between the perturbations to a chemical bond and potential energy; Simple rate laws; Arrhenius equation and Eyring equation, Transition State theory. Kinetics vs Thermodynamic control; Experimental investigation of reaction mechanisms and short lived intermediates; The kinetic Isotope Effect; Reaction trajectories: Cross-over experiments; Characterisation of short lived intermediates; Examples of reactive species and their behavior Supramolecular chemistry. Electron transfer reactions. Organic photochemical transformation (including catalysis).

CML670 Organic Chemistry of Biological Systems

3 Credits (3-0-0)

Pre-requisite(s): CML526

Basic principles of chemical biology illustrated by detailed case studies for principal mechanistic categories of reaction: structure and reactivity; chemical mechanism of enzyme catalysis; chemistry of signaling, biosynthesis, and polyketides, Organic chemistry of biological pathways such as Krebs's cycle, lipid and amino acid biosynthesis, Chemical methods to synthesize DNA and RNA, solid phase synthesis of peptides, Macromolecule synthesis, Combinatorial chemistry, Chemical ligation, bioorthogonal reaction; chemical genetics and small-molecule inhibitor such as phosphorylation, and lipidation. Types of biological assays and their informational content. Chemical methods to synthesize proteins and peptides, Foldamer ligand for a medically relevant target, protein-protein interaction, Ligands for protein surfaces, small molecule arrays.

CML721 Design and Synthesis of Organic Molecules

3 Credits (3-0-0)

Selectivity in organic synthesis: chemo-, regio-, stereo- and enantioselectivity. Target-oriented synthesis: Designing organic synthesis, Retrosynthetic analysis, disconnection approach, linear and convergent synthesis. Diversity-oriented synthesis: concept of forward-synthetic analysis, appendage diversity, skeletal diversity, stereochemical diversity, complexity and diversity. Asymmetric Synthesis: Use of chiral catalysts, organocatalysis, chiron approach and N-heterocyclic carbenes. Principles and use of enzymes in the synthesis of industrially important sugar/fatty acid esters, sugar nucleotide derivatives; enantiomeric pure compounds and biobased platform chemicals.

CMP722 Synthesis of Organic and Inorganic Compounds

3 Credits (0-0-6)

Single, double and multi-stage preparation of organic, inorganic and organometallic compounds; experiments involving the concepts of protecting groups and selectivity; identification of compounds through thin-layer chromatography and their purification by column chromatography. Characterization of synthesized compounds using IR, UV, ¹H-NMR and mass spectrometric techniques.

CML723 Principles and practice of NMR and Optical Spectroscopy

3 Credits (3-0-0)

Fundamentals of FT NMR spectroscopy, relation between structure and NMR properties, one-dimensional spectroscopy (¹H, ¹³C,

DEPT, steady state NOE, saturation transfer) and an introduction to two-dimensional NMR (COSY, NOESY, and HSQC) and their use in structure elucidation. Principles and analytical applications of optical spectroscopic methods including atomic absorption and emission, UV-Visible, IR absorption, scattering, and luminescence.

CML724 Synthesis of Industrially Important Inorganic Materials

3 Credits (3-0-0)

Modern methods applied in the synthesis of inorganic, organometallic and polymer materials. Handling of air and moisture sensitive compounds, dry box, glove bag, Schlenk line and vacuum line techniques. Methods of purification of and handling of reactive industrial gases. Methods of purification of inorganic compounds and crystallization of solids for X-ray analysis. General strategies, brief outline of theory and methodology used for the synthesis of inorganic/organometallic molecules to materials including macromolecules. Emphasis will be placed how to adopt appropriate synthetic routes to control shape and size of the final product, ranging from amorphous materials, porous solids, thin films, large single crystals, and special forms of nanomaterials. A few examples of detailed synthesis will be highlighted in each category of materials.

CML726 Cheminformatics and Molecular Modelling

3 Credits (3-0-0)

Chemistry & Information technology, chemical/biochemical data collation, retrieval, analysis & interpretation, hypothesis generation & validation, development of structure activity/property relationships, artificial intelligence techniques in chemistry. Building molecules on a computer, quantum and molecular mechanics methods for geometry optimization, Simulation methods for molecules and materials.

CMP728 Instrumentation Laboratory

3 Credits (0-0-6)

Experiments based on Instrumental methods of chemical analysis involving spectroscopy, microscopy and thermal methods.

CML729 Material Characterization

3 Credits (3-0-0)

Compositional analysis of solid materials by X-ray and electron microscopic techniques. Basic concepts of diffraction techniques (powder and single crystal) in elucidating the crystal structures organic, inorganic and hybrid materials. Applications of electron microscopic techniques (scanning and transmission) for morphological and nanostructural features. Thermal analytical methods for correlating structural information and monitoring phase transition. Emphasis will be placed on the above techniques for industrially important materials and the interpretation and evaluation of the results obtained by various methods.

CML731 Chemical Separation and Electroanalytical Methods

3 Credits (3-0-0)

Theory and applications of equilibrium and nonequilibrium separation techniques. Extraction, countercurrent distribution, gas chromatography, column and plane chromatographic techniques, electrophoresis, ultracentrifugation, and other separation methods, Modern analytical and separation techniques used in biochemical analysis. Principles of electrochemical methods, electrochemical reactions, steady-state and potential step techniques; polarography, cyclic voltammetry, chrono methods, rotating disc and ring disc electrodes, concepts and applications of AC impedance techniques.

CML733 Chemistry of Industrial Catalysts

3 Credits (3-0-0)

Fundamental aspects of Catalysis - Homogeneous & heterogeneous catalysis -The role of catalytic processes in modern chemical manufacturing -organometallic catalysts -catalysis in organic polymer chemistry -catalysis in petroleum industry - catalysis in environmental control.

CML734 Chemistry of Nanostructured Materials

3 Credits (3-0-0)

Introduction; fundamentals of nanomaterials science, surface science for nanomaterials, colloidal chemistry; Synthesis, preparation and fabrication: chemical routes, self assembly methods, biomimetic and electrochemical approaches; Size controls properties (optical, electronic and magnetic properties of materials) - Applications (carbon nanotubes and nanoporous zeolites; Quantum Dots, basic ideas of nanodevices).

CML737 Applied Spectroscopy

3 Credits (3-0-0)

Applications of advanced 1D-NMR techniques such as nOe, 1D 13C-NMR (including APT and DEPT) techniques, multinuclear NMR spectroscopy, 2D NMR techniques (COSY, HETCOR, HSQC, HMBC, NOESY, ROESY etc.) for the structural and stereochemical determination of organic compounds. Introduction to various types of ionizations (such as EI, CI, MALDI, field ionization/desorption, electrospray ionization) and analyzers (such as quadrupole, time of flight, triple quadrupole, QqTOF, ion-trap) in mass spectrometry for MS, MS/MS and MSn applications. Determination of peptide sequencing using mass spectrometric techniques.

CML738 Applications of P-block Elements and their Compounds

3 Credits (3-0-0)

Introduction, Structure, bonding and recent discussions on d orbital participation. Boranes, carboranes and metallaboranes and their use in BNCT and as control rods in nuclear reactors, modern electron counting methods such as Jemmis rules, chemistry of B(0) and B(1). GaAs, GaN, InSnO3: Synthesis and applications in solar cells, LED and as transparent conducting materials. Fullerenes, nanotubes, graphene, silicates, aluminosilicates, zeolites and their applications. Silicones and their industrial applications. Si(II) and Ge(II) chemistry. NHC's and their use in stabilizing main group compounds. Nitrogen based fertilizers, Ammonia, Haber-Bosch Process, nitrogen based explosives, hydrazines as rocket fuels, applications of azides and pentazenium. Phosphorus based fertilizer processes, phosphorus based pesticides, phosphorus-nitrogen compounds as multidentate ligands, superbases, dendrimer cores and polymers. Phosphines and their industrial uses. Frustrated Lewis acid bases as catalysts. Superacids and their uses. Sulphonamides, industrial applications of sulfur and selenium. Fluorine in pharmaceuticals, fluoropolymers.

CML739/695 Applied Biocatalysis

3 Credits (3-0-0)

Introduction to enzymes and enzyme catalysed reactions. Classification and mechanism of reaction. Purification and characterization of enzymes. Michaelis-Menten kinetics, Industrial enzymes. Applications of enzymes in diagnostics, analysis, biosensors and other industrial processes and bio-transformations. Enzyme structure determination, stability and stabilisation. Enzyme immobilization and concept of enzyme engineering. Nanobiocatalysis.

CML740/675 Chemistry of Heterocyclic Compounds

3 Credits (3-0-0)

Chemistry of heterocyclic compounds containing one, two and three heteroatoms. Total synthesis of representative natural products.

CML741 Organo and organometallic catalysis

3 Credits (3-0-0)

Introduction. Enamine catalysis. Iminium catalysis. Asymmetric proton catalysis. Ammonium ions as chiral templates. Chiral Lewis bases as catalysts. Asymmetric acyl transfer reactions. Ylide based reactions. Transition metal catalyzed reactions. C-H activation. N-Heterocyclic carbenes.

CML742 Reagents in Synthetic Transformations

3 Credits (3-0-0)

The course will cover the applications of various oxidation and

reduction reactions in organic chemistry with special emphasis on special reagents that are used for selective transformations. Use of organolithium and organoboron compounds in organic synthesis and olefin metathesis will also serve a part of the course.

CML743 Physical Organic Chemistry Advanced

3 Credits (3-0-0)

Overlap with: CML696

Basic MO theory, Frontier Orbitals and orbital mixing; Reactive intermediates; Relationship between potential energy and the perturbation to a chemical bond: Potential Energy Surfaces and the Reaction Coordinate; Simple rate laws (unimolecular and bimolecular); Arrhenius equation and Eyring equation, Transition State theory. Kinetics vs Thermodynamics control; Experimental investigation of reaction mechanisms and short lived intermediates; The Kinetic Isotope Effect; Reaction trajectories: Cross-over experiments; Characterisation of short lived intermediates; Examples of reactive species and their behavior Supramolecular chemistry. Electron transfer reactions. Organic photochemical transformation (including catalysis).

CMD799 Minor project

3 Credits (0-0-6)

CML801 Molecular Modelling and Simulations: Concepts and Techniques

3 Credits (3-0-0)

Review of Basic Concepts: Length and Time Scales, Intermolecular Interactions and Potential Energy Surfaces, Evaluation of Long-range interactions Static and Dynamic Properties of Simple and Complex Liquids Molecular Dynamics: Microcanonical and other ensembles; Constrained simulations; non-equilibrium approaches Monte Carlo Methods: Random Numbers and Random Walk, Metropolis Algorithm in various ensembles, Biased Monte Carlo Schemes Free Energy Estimations: Mapping Phase Diagrams, Generating Free Energy Landscapes, Collective Variables Rare Event Simulations and Reaction Dynamics VII. Advanced Topics: First principles molecular dynamics, Quantum Monte Carlo methods, Coarse-Graining and Multiscale Simulations for Nanoscale Systems, Quantum mechanics/molecular mechanics (QM/MM) approaches. (To some extent, coverage of advanced topics will depend on research interests of students and faculty since this is a Pre-Ph.D. course).

CMD806 Major Project Part-I

6 Credits (0-0-12)

CMD807 Major Project Part-II

12 Credits (0-0-24)

Department of Civil Engineering

CVL100 Environmental Science

2 Credits (2-0-0)

Pollutant sources and control in air and water, solid waste management, noise pollution and control, cleaner production and life cycle analysis, reuse, recovery, source reduction and raw material substitution, basics of environmental impact assessment, environmental risk assessment and environmental audit, emerging technologies for sustainable environmental management, identification and evaluation of emerging environmental issues with air, water, wastewater and solid wastes.

CVL111 Elements of Surveying

4 Credits (3-0-2)

Introduction to Surveying, Levels, Theodolites, total station. Measurement of distances, directions and elevations. Traversing. Trigonometric levelling. Mapping and contouring. Measurement of areas, volumes. Quantity computations. Errors of measurements and their adjustments. Curve setting: simple, compound and reverse curves. Introduction to GPS, Differential GPS, Remote sensing techniques and application in land use change and mapping, arial surveying, photogrametry.

CVL121 Engineering Geology

3 Credits (3-0-0)

Engineering Geology: Introduction; Dynamic Earth; Origin, Age, Interior, Materials of Earth; Silicate Structures and Symmetry Elements; Physical properties, Formation of Rocks; Igneous, Sedimentary and Metamorphic processes and structures, Characterisation; Weathering Processes; Geological Work of Rivers, Glaciers, Wind and Sea/Oceans, Deposits and Landforms; Formation of Soils; Geological Time Scale; Structural Features, Attitude of beds, Folds, Joints, Faults, Plate tectonics; Stress Distribution; Geophysical methods, Earthquakes. Engineering Properties of Rocks; Rock as Construction Material; Geological Site Criteria for Tunnels and Underground Structures, Foundations, Dams, Rock Slopes and Landslides.

CVP121 Engineering Geology Lab

1 Credit (0-0-2)

Pre-requisite(s): CVL121 or concurrent with CVL121

Geological Maps, Geological Mapping – contouring, topo sheets, outcrops, apparent and true dips, three point problems, depth and thickness problems, joints, faults; Megascopic and Microscopic identification of Minerals and Rocks, Engineering properties of rocks, refraction and resistivity methods, Guided tour through representative geological formations and structures.

CVL141 Civil Engineering Materials

3 Credits (3-0-0)

Mechanical properties of engineered materials, Temperature and time effects. Failure and safety. Non-mechanical properties. Durability. Nature of materials, classes of materials based on bonding, inorganic and organic solids. Variability in materials and its implication on measurement. Cement based materials, concrete production and processes; properties. Steel and other metals used in construction. Bricks and Masonry; wood and engineered wood products; glass and heat transmission properties. Polymers for construction and maintenance of infrastructure. Composites: fiber reinforced composites, particle reinforced composites. Introduction to sustainable materials.

CVL212 Environmental Engineering

4 Credits (3-0-2)

Pre-requisite(s): CVL100

Water and wastewater treatment overview; Unit processes: systems of water purification, processes (sedimentation, coagulation-flocculation, softening, disinfection, adsorption, ion exchange, filtration) and kinetics in unit operation of water purification-theory and design aspects; distribution of water layout systems: design aspects; Wastewater engineering: systems of sanitation, wastewater collection

systems design and flows; Characteristics and microbiology of wastewater, BOD kinetics; Unit processes for wastewater treatment (screening, sedimentation; biological aerobic and anaerobic process)-theory and design aspects; Biological processes (Nutrient and phosphorous removal); advanced wastewater treatment-theory and design aspects; Air pollution (health effects, regulatory standards, dispersion; stacks, control systems); Municipal solid waste management; Noise pollution.

CVL222 Soil Mechanics

3 Credits (3-0-0)

Origin and Classification of Soils; Phase Relationships; Effective Stress Principle; Effective Stress Under Hydrostatic and 1D flow; Permeability; Flow Through Soils–Laplace equation, flownets, seepage; Contaminant Transport; Compressibility; Consolidation; Terzaghi's 1D Consolidation Theory; Shear Strength; Drainage Conditions; Pore Water Pressure; Mohr's Circle; Failure Envelope and Strength Parameters; Factors Affecting Shear Strength; Critical State frame work; Behaviour of soils under cyclic loading, Liquefaction; Compaction; Engineering properties of Natural soils, Compacted Soils and modified soils; Site Investigations; Soil deposits of India.

CVP222 Soil Mechanics Lab

1 Credit (0-0-2)

Pre-requisite(s): CVL222 or concurrent with CVL222

Visual Soil Classification; Water Content; Atterberg Limits; Grain Size Analysis; Specific Gravity; Permeability; standard proctor compaction test, consolidation test, site investigations and introduction to triaxial testing.

CVL242 Structural Analysis I

3 Credits (3-0-0)

Pre-requisite(s): APL108

General Concept of Static Equilibrium of Structures, Concept of Free Body Diagram, Analysis of Statically Determinate Trusses, Energy Methods for Determination of Joint Displacements - Castigliano Theorem, Unit Load Method etc., Introduction to Analysis of Statically Indeterminate Trusses using Energy Methods, Analysis of Statically Determinate Beams - Moment Area Theorem, Conjugate Beam Method, Maxwell Betti Theorem, Method of Superposition, Application of Energy Methods to Statically Determinate Beams and Rigid Frames, Solving Simple Indeterminate Beams Structures using Energy Methods, Analysis of Rolling Loads and Influence Line Diagram, Analysis of Arches and cable structures.

CVP242 Structural Analysis Lab

1 Credit (0-0-2)

Pre-requisite(s): CVL242 or Concurrent with CVL242

Determination of forces and displacements in statically determinate and indeterminate trusses, Influence Line Diagram for Trusses, Measurement of bending moment and shear forces in beams, Determination of Elastic Properties of Beams, Verification of the Moment Area Theorem, Maxwell Betti Theorem, Influence Line Diagram for Displacement, Support Reaction, Shear Force at an Intermediate Section and Bending Moment, Determination of Carry over Factor, Verification of Carry Over Factor, Determination of displacements in curved members, Analysis of Elastically Coupled Beams, Determination of horizontal reactions in two and three hinged arches, experiment on cable structures.

CVL243 Reinforced Concrete Design

3 Credits (3-0-0)

Pre-requisite(s): CVL141

Design Philosophy: Working stress and limit state design concepts; Design of and detailing of RC beam sections in flexure, shear, torsion and bond; Design for serviceability; Design of RC beams, One way and two way RC slabs, RC short and long columns, RC footings.

CVP243 Materials and Structures Laboratory Concrete

1.5 Credits (0-0-3)

Testing of cement, testing of aggregates, mixture design and testing, non-destructive tests, testing of reinforcement, behaviour of reinforced concrete beams under flexure and torsion, behaviour of reinforced concrete slabs under uniform and point loads, behaviour of reinforced concrete columns under concentric and eccentric loads.

CVL244 Construction Practices

2 Credits (2-0-0)

Pre-requisite(s): EC35

Introduction and role of technologies, Construction technologies in RC Buildings for Reinforcement, Formwork, and concreting activities, Excavation and Concreting equipment, Formwork material and Design Concepts, Formwork system for Foundations, walls, columns, slab and beams and their design, Flying Formwork such as Table form, tunnel form. Slipform, temporary structures failure, Determining construction loads and ensuring safety of slabs during construction of high rise buildings- shoring, reshoring, preshoring and backshoring technology, Top down construction technology for high rise and underground construction, Bridge construction including segmental construction, incremental construction and push launching techniques, Prefab construction.

CVL245 Construction Management

2 Credits (2-0-0)

Pre-requisite(s): EC35

Introduction to construction projects, stakeholders, phases in a project, Cost estimation from clients perspective, Project selection using time value of money concept, construction contract, cost estimate –contractors perspective, Project planning and network analysis- PERT, CPM, and Precedence Network, Resource scheduling, Time Cost trade off, Time -cost monitoring and control using S-curve and earned value analysis, Construction claims and disputes, and introduction to construction quality and safety.

CVL261 Introduction to Transportation Engineering

3 Credits (3-0-0)

Pre-requisite(s): CVL111

Transportation systems and their classification; Role of transportation with respect to socio-economic conditions; Transportation planning process; Road user and the vehicle; Geometric design of roads: horizontal alignment, vertical alignment, cross-section elements; Relevant geometric design standards; Pavements: flexible and rigid; Characterization of pavement materials; Analysis and design of pavement systems; Pavement design specifications; Pavement construction process; Pavement performance; Traffic engineering: Traffic characteristics; Fundamental relationships; Theories of traffic flow; Intersection design; Design of traffic signs and signals; Highway capacity.

CVP261 Transportation Engineering Lab

1 Credit (0-0-2)

Pre-requisite(s): CVL261 or Concurrent with CVL261

Introduction to material behavior; Characterization of materials used in pavement construction: soil, aggregate, asphalt, asphalt concrete; Introduction to traffic survey methodologies; Traffic surveys: speed studies, intersection study.

CVL281 Hydraulics

4 Credits (3-1-0)

Pre-requisite(s): APL107

Open Channel Flow: Channel Characteristics and parameters, Uniform flow, Critical flow, Specific Energy concepts, Gradually Varied Flows, Rapidly Varied flow with special reference to hydraulic jump, Unsteady flow in open channels.

Boundary Layer Theory: Navier Stokes Equation, Boundary Layer

Equation in 2-dimension, Boundary layer characteristics, Integral Momentum equation, onset of turbulence, properties of turbulent flow, skin friction, application of drag, lift and circulation to hydraulic problems.

Pipe Flow: Laminar and Turbulent flow in Smooth and Rough pipes, pipe network analysis, Losses in pipes

Fluvial Hydraulics: Settling velocity, Incipient motion, Resistance to flow and bed forms, Sediment load and transport.

CVP281 Hydraulics Lab

1 Credit (0-0-2)

Pre-requisite(s): CVL281 or Concurrent with CVL281

Experiments on Open Channel Flow Hydraulics, Boundary Layer Theory, Pipe flow, Sediment transport.

CVL282 Engineering Hydrology

4 Credits (3-0-2)

Pre-requisite(s): APL107

Hydrologic Cycle, Processes and Applied Methodologies. Rainfall; Evapotranspiration; Infiltration;

Groundwater: Occurrence, Movement, Governing equations, Well hydraulics.

Runoff: Hydrograph, Unit Hydrographs; Streamflow measurement.

Flood Routing: Hydrological routing for reservoirs and channels.

Frequency Analysis.

CVL284 Fundamentals of Geographic Information Systems

3 Credits (2-0-2)

Pre-requisite(s): COL100

What is GIS. Geographic concepts for GIS. Spatial relationships, topology, spatial patterns, spatial interpolation. Data storage, data structure, non-spatial database models. Populating GIS, digitizing data exchange, data conversion. Spatial data models, Raster and Vector data structures and algorithms. Digital Elevation Models (DEM) and their application. Triangulated Irregular Network (TIN) model. GIS application areas, Spatial analysis, quantifying relationships, spatial statistics, spatial search. Decision making in GIS context.

CVL311 Industrial Waste Management

3 Credits (3-0-0)

Pre-requisite(s): CVL212

Industrial waste types and characteristics; levels of environmental pollution due to industrial wastes; health issues due to industrial wastes; ecological and human health risk assessment due to industrial wastes; waste characterization methods; treatment methods-conventional and recent trends (for air, water, soil media); Prevention versus control of industrial pollution; hierarchy of priorities for industrial waste management; comparison of real-life industrial waste management practices (ex: superfund remedial sites, etc.); economics of industrial waste management and sustainability issues; environmental rules and regulations; clean up goals; disposal/reuse of treated wastes; Source reduction and control of industrial water and air pollution; Minimization of industrial solid and hazardous waste; Waste management case studies from various industries.

CVL312 Environmental Assessment Methodologies

3 Credits (3-0-0)

Pre-requisite(s): CVL212

Environmental issues related to developmental activities: Nature and characteristics of environmental impacts of urban and industrial developments.

Linkages between technology, environmental quality, economic gain, and societal goals.

Environmental indices and indicators for describing affected environment. Methodologies and environmental systems modeling tools for prediction and assessment of impacts on environmental quality (surface water, ground water, air, soil).

Monitoring and control of undesirable environmental implications. Environmental cost benefit analysis. Decision methods for evaluation of environmentally sound alternatives.

Environmental health and safety: Basic concepts of environmental risk and definitions; Hazard identification procedures; Consequence analysis and modeling (discharge models, dispersion models, fire and explosion models, effect models etc.).

Emerging tools for environmental management: Environmental Management Systems, Environmentally sound technology transfer, emission trading, international resource sharing issues, climate change, international environmental treaties and protocols. Case studies.

CVL313 Air and Noise Pollution

3 Credits (3-0-0)

Pre-requisite(s): CVL212

Definitions, source and types of air and noise pollution, physical and chemical properties of air pollutants, secondary pollutants formation, instrument design and industrial application, gas phase adsorption and biofiltration, carbon Credit, global warming potential, case studies, data analysis, interpretation.

CVL321 Geotechnical Engineering

4 Credits (3-1-0)

Pre-requisite(s): CVL222

Foundations: types, selection and design considerations; Bearing capacity of shallow foundations: Terzaghi theory, factors affecting; Bearing capacity of deep foundations: single pile analysis, pile tests, pile driving formula, group capacity, introduction to laterally loaded piles; Settlement of shallow and deep foundations: stress distribution, immediate and consolidation settlements; Slope stability analysis: infinite slopes, method of slices, Swedish circle method; Earth dams: types and design aspects; Earth pressure analysis: Rankine and Coulomb methods; Earth retaining structures: types, design aspects, underground structures; Earthquake geotechnics: evaluation of liquefaction potential, seismic slope stability, seismic bearing capacity; Machine foundations: types, analysis, design procedure; Ground improvement techniques: types, deep stabilization, anchorage, grouting; Geosynthetics: types, functions, properties; reinforced soil walls; Geoenvironment: Landfills - types, liner, cover, stability; Ash ponds - stage raising, design aspects.

CVL321 Geotechnical Engineering Lab

1 Credit (0-0-2)

Pre-requisite(s): CVL321 or Concurrent with CVL321

Vane shear test, Direct shear test, Specimen preparation, Unconfined compression test, Unconsolidated undrained test, Consolidated drained test, Consolidated undrained test with pore water pressure measurement.

CVL341 Structural Analysis II

3 Credits (3-0-0)

Pre-requisite(s): CVL242

Determinacy and stability; Method of consistent deformations- Matrix formulation, Application to beams, trusses and frames; Slope-deflection method and Moment-distribution method- Beams and frames with uneven loading, support settlements, dealing with symmetry and anti-symmetry, Non-sway and sway frames; Matrix stiffness method; Matrix flexibility method; Energy methods; Approximate methods of analysis; Direct stiffness method for computer applications including computational aspects and MATLAB Assignments.

CVL342 Design of Steel Structures

3 Credits (3-0-0)

Pre-requisite(s): CVL242

Structural steel and properties, Design philosophy-Working stress and limit state; Connection types- Riveted, bolted and welded; Design

of tension, compression and flexural members; Design of members subjected to combined loadings-Axial and bending, Torsion, Biaxial bending; Column bases, Gantry and plate girders; Roof trusses; Plastic design; Introduction to stability concepts, Design of shed-type structures.

VVP342 Materials and Structures Laboratory-Steel

1 Credit (0-0-2)

Basic properties of structural steel; Tensile stress-strain behaviour; Buckling of slender columns, Flexural testing of beams; Torsional behaviour of beams, Unsymmetrical bending; Lateral-torsional buckling; Flexural-torsional buckling; Connection behaviour; Tension-field action in plate girders.

CVL344 Construction Project Management

3 Credits (3-0-0)

Pre-requisite(s): CVL245

Additional network analysis- Ladder Network, LoB,etc., Time constrained Resource allocation and resource constrained problems, Time Cost trade off, project updating and control using EVM, Construction contracts and its types, tendering procedure, estimation and fixing of markup, bidding models, claims compensation and disputes, dispute resolution models, FIDIC contracts, Linear programming, Problems in construction, Formulation, Graphical solution, Simplex method, Dual problem, sensitivity analysis and their application to Civil engineering, Transportation Assignment problems and their applications

CVL361 Introduction to Railway Engineering

3 Credits (3-0-0)

Pre-requisite(s): CVL261

History: Indian railways, international perspective; Railway track gauge: factors affecting gauge choice, multi gauge; New project planning and surveys; Alignment of railway track; Structure of railway track: rails, sleepers, ballast, subgrade, track fittings; Structural design of railway track: stresses, creep; Geometric design of rail track: gradients, curves, superelevation; Locomotives and rolling stock: resistance and tractive power; Points and crossings; Railway stations and yards; Traffic control; Signalling and interlocking; Public rail transportation in metros.

CVL381 Design of Hydraulic Structures

4 Credits (3-0-2)

Pre-requisite(s): CVL281 and CVL282

Input studies.

Storage structures: Dams and reservoirs, Different types of dams and selection of suitable type and dam site, Gravity dam, Embankment dams. Diversion works: Design concepts for irrigation structures on permeable foundations, Design of Weirs and barrages. Design of energy dissipation devices. Canals: canal layout, Regime canal design, Rigid boundary canal design. Design of canal falls. Design of cross drainage works. Design of head regulator, cross regulator and canal outlet structures.

CVL382 Groundwater

2 Credits (2-0-0)

Pre-requisite(s): CVL282 or EC 75

Introduction, importance and occurrence of groundwater; Aquifers and groundwater scenario in India; Surface and subsurface investigation of groundwater; Construction, development and maintenance of wells; Flow through porous media, Darcy's law, regional flow; Well hydraulics; Groundwater management.

CVL383 Water Resources Systems

2 Credits (2-0-0)

Pre-requisite(s): CVL282

Water Resources Planning Purposes and Objectives; Multi-component, multi-user, multi-objective and multi-purpose attributes of an

Integrated Water Resources System; Economic basis for selection of a Plan Alternative; Introduction to Linear Programming and applications in Water Resources Engineering; Linear, Deterministic Integrated Water Resources Management Model on River Basin Scale.

CVL384 Urban Hydrology

2 Credits (2-0-0)

Pre-requisite(s): CVL282 or EC 75

Distinctive characteristics of natural and urban watersheds; Urban Heat Island; Changes in rainfall, infiltration and runoff characteristics in urban watershed; IDF relationship and its adaptation for urban settings; Adjusting runoff record for urbanization; Stormwater Management and rainwater harvesting; Urban drainage: layout, structures, flooding and control, combined sewer overflows, sedimentation; Management of stormwater.

CVL385 Frequency Analysis in Hydrology

2 Credits (2-0-0)

Pre-requisite(s): CVL282

Concepts of probability in Hydrology, Random events, Random variables; moments and expectations; Common probabilistic distributions; goodness of fit tests; Stochastic processes.

CVL386 Fundamentals of Remote Sensing

3 Credits (2-0-2)

Pre-requisite(s): EC 75

What is Remote Sensing? Historical development of remote sensing, Remote sensing components, Data collection and transmission, Sensors and satellite imageries, Electromagnetic energy and spectrum, Wavebands, Interactions of electromagnetic energy with atmosphere and earth's surface, radiometric quantities, Photogrammetry and aerial photography, Vertical and tilted photographs, Photographic materials, Photo-processes, Stereoscopic viewing, fly view, Aerial mosaics, Various satellite systems and monitoring programs, Data Products, Satellite data, Data formats, Data acquisition for natural resources management and weather forecast, Random errors and least square adjustment, Coordinate transformation, Photographic interpretation, Image processing, Potential applications of remote sensing in diverse areas and decision making, Integrated use of remote sensing and GIS, Case studies.

CVD411 B.Tech. Project Part-I

4 Credits (0-0-8)

CVD412 B.Tech. Project Part-II

6 Credits (0-0-12)

CVL421 Ground Engineering

3 Credits (3-0-0)

Pre-requisite(s): CVL321

Planning of investigation programmes, Geophysical methods. Methods of site investigations: Direct methods, semi-direct methods and indirect methods, Drilling methods. Boring in soils and rocks, Methods of stabilizing the bore holes, measurement of water table, field record. Principles of compaction, Laboratory compaction, Engineering behaviour of compacted clays, Field compaction techniques- static, vibratory, impact, Compaction control. Shallow stabilization with additives: Lime, fly ash, cement and other chemicals and bitumen; Deep Stabilization: sand column, stone column, sand drains, prefabricated drains, electroosmosis, lime column. soil-lime column, blasting. Grouting : permeation, compaction and jet. Vibro-floatation, dynamic compaction, thermal freezing. Dewatering systems. Functions and applications of geosynthetics – geotextiles, geogrids, geomembranes; soil reinforcement using strips, bars and geosynthetics; soil nailing and ground anchors, Earthmoving machines and earthwork principles, Piling and diaphragm wall construction, Tunneling methods in soils, Hydraulic barriers and containment systems for waste disposal in soil, Control and remediation of soil contamination.

CVL422 Rock Engineering

3 Credits (3-0-0)

Pre-requisite(s): CVL321

Geological classification, rock and rock mass classification, strength and deformation behaviour of rocks, pore pressures, failure criteria, laboratory and field testing, measurement of in-situ stresses and strains, stability of rock slopes and foundations, design of underground structures, improvement of in situ properties of rock masses and support measures.

CVL423 Soil Dynamics

3 Credits (3-0-0)

Pre-requisite(s): CVL321

Engineering problems involving soil dynamics; Role of inertia; Theory of Vibrations: Single and two-degree freedom systems; Wave propagation in elastic media; Soil behaviour under cyclic/dynamic loading; Small and large strain dynamic properties of soils; Design criteria for machine foundations; Elastic homogeneous half space and lumped parameter solutions; Vibration isolation; Codal provisions; Causes of Earthquakes; Strong Ground Motion: Measurement, characterization and estimation; Amplification theory and ground response analysis; Liquefaction of soil and its remediation; Seismic slope stability; Seismic bearing capacity and earth pressures

CVL424 Environmental Geotechniques & Geosynthetics

3 Credits (3-0-0)

Pre-requisite(s): CVL321

Causes and effects of subsurface contamination; Waste disposal on land; Characteristics of solid wastes; Waste Containment Principles; Types of landfills; Planning of landfills; Design of liners and covers for landfills; Environmental Monitoring around landfills; Detection, control and remediation of subsurface contamination; Geotechnical re-use of solid waste materials.

Types of geosynthetics; Manufacturing; Functions; Testing and evaluation; Designing with geotextiles, geogrids, geonets and geomembranes.

CVL431 Design of Foundations & Retaining Structures

3 Credits (3-0-0)

Pre-requisite(s): CVL321

Shallow Foundations: Bearing Capacity, Generalized bearing capacity theory, Empirical methods, Layered soil, Foundations on or near slopes, Settlement of foundations, codal provisions.

Pile Foundations: Types and their selection, Ultimate load of individual piles in compressive, uplift, and lateral loading, Pile load tests, Downdrag, Pile groups. Caissons. Codal provisions.

Earth Retaining Structures: Types, Earth pressures, Design of rigid, flexible and reinforced soil retaining walls, braced excavations, and ground anchors for retaining walls.

Introduction to design of foundation for dynamic loads.

CVL432 Stability of Slopes

2 Credits (2-0-0)

Pre-requisite(s): CVL321

Slope Stability: Short term and long term stabilities; Limit equilibrium methods; Infinite slopes; Finite height slopes - Swedish method, Bishop's simplified method, Stability charts; Conditions of analysis - steady state, end of construction, sudden draw down conditions; Factor of safety; Codal provisions; Earthquake effects. Seepage Analysis: Types of flow; Laplace equation; Flownet in isotropic, anisotropic and layered media; Entrance-exit conditions; Theoretical solutions; Determination of phreatic line. Earth Dams: Introduction; Factors influencing design; Design of components; Instrumentation. Reinforced Slopes: Steep slopes; Embankments on soft soils; Reinforcement design.

CVL433 FEM in Geotechnical Engineering

3 Credits (3-0-0)

Pre-requisite(s): CVL321

Steps in FEM. Stress-deformation analysis: One dimensional, Two dimensional and Three-dimensional formulations. Discretization of a Continuum, Elements, Strains, Stresses, Constitutive, Relations, Hooke's Law, Formulation of Stiffness Matrix, Boundary Conditions, Solution Algorithms.

Settlement Analysis, 2-D elastic solutions for homogeneous, isotropic medium, Steady Seepage Analysis: Finite element solutions of Laplace's equation, Consolidation Analysis: Terzaghi consolidation problem, Choice of Soil Properties for Finite Element Analysis, Introduction to PHASE 2.

CVP434 Geotechnical Design Studio

2 Credits (0-0-4)

Pre-requisite(s): CVL321

Seepage analysis through an earth dam. Slope stability analysis of a dam. Settlement analysis of shallow and deep foundations; Analysis and design of retaining structures; Analysing the structural forces in a tunnel lining.

CVL435 Underground Structures

2 Credits (2-0-0)

*Pre-requisite(s): CVL321**Overlaps with: CVL713*

Types and classification of underground structures, Functional aspects, Sizes and shapes, Support systems, Design methodology.

Stresses-deformation analysis of openings (circular, elliptical, spherical, ellipsoidal) using analytical and numerical methods.

Design of underground structures using analytical methods, empirical methods and observational methods, Rock support interaction analysis, NATM Hydraulic tunnels, Shafts, Tunnel portals, Metro tunnels.

CVL441 Structural Design

3 Credits (3-0-0)

Pre-requisite(s): CVL241, CVL243, CVL342

Design of Reinforced Cement concrete (RCC) Structures – Building frames Liquid retaining structures, Earth Retaining walls.

Design of Steel Structures – Plate girders, gantry girders and steel bridge components.

CVP441 Structural Design & Detailing

1.5 Credits (0-0-3)

*Pre-requisite(s): CVL243, CVL342***Part-I Concrete Structures**

Computer-aided analysis and design of real-life reinforced concrete (RC) structure. Dimensioning of concrete elements based on modular formworks available in construction industry. Detailing of concrete elements in terms of reinforcement, curtailment, lapping, splicing of reinforcements and connection with adjoining elements in the structure; member drawings. Joint detailing from ductility view point, Indian standard (IS) code recommendations and practical intricacies involved in casting and handling of the RC members, its sequence of construction and constructability.

Part-II Steel Structures

Computer-aided analysis and design of real-life steel structure. Steel member details as per shop/ field activities for welding/ bolting; i.e. fabrication (shop) drawings. Connection details, gusset plate design and detailing from ductility view point, Indian standard (IS) code recommendations and practical intricacies involved in fabrication and handling of the steel members, its sequence of erection and constructability.

CVL442 Structural Analysis-III

3 Credits (3-0-0)

Pre-requisite(s): CVL341

Introduction to FEM for structural analysis with review of energy methods-2D plane stress and plane strain elements, beam element, 2D bending element, example problems, elements of structural dynamics-free and forced vibration of SDOF system, treatment of impact and arbitrary loading, frequency and time domain analysis; free vibration mode shapes and frequencies of MDOF systems; normal mode theory for forced vibration analysis of MODF system; example problems. Elements of plastic analysis; upper and lower bound theorems; methods of collapse mechanism; application to beams and multistory frames; example problems.

CVL443 Prestressed Concrete & Industrial Structures

3 Credits (3-0-0)

Pre-requisite(s): CVL241, CVL243, CVL341

Prestressed Concrete Structures-Fundamentals of presenting, Prestressing technology, Analysis of prestressed losses, Design for Flexure, Design for shear and torsion, Design of anchorage Zones in Post-tensioned members.

Industrial Structures-Analysis and design of Cylindrical shell structures, Folded plates, Chimneys, Silos, Bunkers.

CVL461 Logistics and Freight Transport

3 Credits (3-0-0)

*Overlaps with: SML843**Pre-requisite(s): CVL261 or Instructor's permission*

Evolution of freight and logistics; Interrelationships between society, environment and freight transport; Survey methodologies to understand freight movement; Cost measurement: Production, Holding, Transportation, Handling; Effect of internal and external variables on cost; Demand forecasting; Inventory planning and management; Transportation and distribution network: Design, Development, Management; Ware house operations; Pricing: Perishable, seasonal demand, uncertainty issues; Vehicle routing: One-to-one distribution, One-to-many distribution, Shortest path algorithm, Quickest time algorithm; Logistics information system; Designing and planning transportation networks; Multi-modal transportation issues.

CVL462 Introduction to Intelligent Transportation Systems

3 Credits (3-0-0)

Pre-requisite(s): CVL261

Introduction to Intelligent Transportation Systems (ITS); ITS Organizational Issues, the fundamental concepts of Intelligent Transportation Systems (ITS) to students with interest in engineering, transportation systems, communication systems, vehicle technologies, transportation planning, transportation policy, and urban planning. ITS in transportation infrastructure and vehicles, that improve transportation safety, productivity, environment, and travel reliability. Mobile device applications of ITS such as trip planners.

CVL481 Water Resources Management

3 Credits (3-0-0)

Pre-requisite(s): CVL282 and EC 100

Scope of water resources management, Global trends in water utilization, Crop water requirements and irrigation, Planning and desing of various irrigation methods, Soil salinity and water logging, Hydropower systems management, Strom water system management, Economic analysis of water resources projects, Flood Control studies.

CVL482 Water Power Engineering

3 Credits (2-0-2)

Pre-requisite(s): CVL281 and EC 100

Basic principle of hydropower generation, Hydropower Project Planning, Site selection, Hydropower development schemes, Reservoir

storage, Assessment of power potential, Hydrologic analysis: Flow duration and load duration curves, Dependable flow, Design flood, Reservoir operation; Hydraulic design of various components of hydropower plants: intakes, hydraulic turbines, conduits and water conveyance, penstock; Performance characteristics of turbines, Specific and unit quantities, Electrical load on hydro-turbines, Power house dimension and planning, Water hammer and surge analysis, Surge tanks, Small and micro hydro power development, tidal plants, Current scenarios in hydropower development, Project feasibility, Impact of hydropower development on water sources systems, environment, socioeconomic conditions and national economy.

CVL483 Groundwater & Surface-water Pollution

2 Credits (2-0-0)

Pre-requisite(s): CVL282 and EC 100

Groundwater contamination; River and Lake pollution; Pollution sources, Geogenic and anthropogenic pollution; Soil Pollution; Contaminant transport mechanisms; Pollution control, remediation technologies and role of wetlands. Environmental impact assessments, Hydrological impacts, Vulnerability, Case studies.

CVP484 Computational Aspects in Water Resources

3 Credits (1-0-4)

Pre-requisite(s): CVL281 and EC 100

Numerical Interpolation and Integration and application to water resources problems; Numerical solution of differential equations in Water Resources such as groundwater flow, pipe flows, open channel flows.

CVL485 River Mechanics

3 Credits (2-0-2)

Pre-requisite(s): CVL281 and EC 100

Introduction, river morphology, drainage patterns, stream order. Properties of mixture of sediment and water, Incipient motion and quantitative approach to incipient motion, channel degradation and armoring. Bed forms and resistance to flow, various approaches for bed load transport, suspended load profile and suspended load equations, total load transport including total load transport equations. Comparison and evaluation of sediment transport equations. Stable channel design with critical tractive force theory.

CVL486 Geo-informatics

3 Credits (2-0-2)

Pre-requisite(s): EC 100

Geospatial and temporal data, Data acquisition, Global positioning system, Global Navigational Satellite System, GPS survey, Aerial and laser scanning surveys, Data acquisition using remote sensing techniques, Sensors and satellite imageries, Stereoscopic 3D viewing, Fly view, Satellite data formats and specifications, Data acquisition for natural resources management and weather forecast, Image processing and interpretation, GIS concepts and Spatial data models, Introduction to microwave remote sensing & LiDAR, Geospatial analysis, DEM/DTM generation & 3D modelling, Inferential statistics, Spatial interpolation, Integrated use of geospatial technologies, Applications and case studies.

CVD700 Minor Project

3 Credits (0-0-6)

CVL700 Engineering Behaviour of Soils

3 Credits (3-0-0)

Origin, nature and distribution of soils. Description of individual particle. Clay mineralogy, clay-water-electrolytes. Soil fabric and structure. Effective stress principle. Steady state flow in soils. Effect of flow on effective stress. Determination of coefficient of permeability. Consolidation: one, two, three dimensional and radial consolidation. Various consolidation tests and determination of parameters. Stress-path. Triaxial and direct shear tests. Shear behaviour of soils under static and dynamic loads. Factors affecting shear behaviour.

Determination of parameters. Shear behavior of fine grained soils. Pore-pressure parameters. UU, CU, CD tests. Total and effective stress-strength parameters. Total and effective stress-paths. Water content contours. Factors affecting strength : stress history, rate of testing, structure and temperature. Anisotropy of strength, thixotropy, creep. Determination of in-situ undrained strength. Stress-strain characteristics of soils. Determination of modulus values. Critical state model, Engineering behaviour of soils of India: Black cotton soils, alluvial silts and sands, laterites, collapsible and sensitive soils.

CVP700 Soil Engineering Lab

3 Credits (0-0-6)

Laboratory Tests: Preparation of samples-Sand and Clay, Consolidation test, Direct shear test, Vane shear test, Unconfined compression test, Unconsolidated undrained triaxial test, Consolidated drained triaxial test, Consolidated undrained triaxial test with pore water pressure measurement, Free swell index test, Swelling pressure test.

Field Investigations and field tests: Drilling of bore hole, standard penetration test. undisturbed and representative sampling. SCP Test, Electrical resistivity, Plate load test, Pile load test.

CVL701 Site Investigation and Foundation Design

3 Credits (3-0-0)

Site Investigation: Geophysical methods-Seismic, electrical; Drilling methods; Boring in soils and rocks. Field tests: In-situ tests, SPT, DCPT, SCPT, in-situ vane shear test, pressure meter test, plate load test. Sampling techniques and disturbances. Shallow Foundations: Design considerations, codal provisions. Bearing capacity theories, Layered soils, Choice of shear strength parameters. Bearing capacity from field tests. Total and differential settlements. Deep foundations: Types of piles. Construction methods. Axial capacity of single piles. Axial capacity of groups. Settlement of single piles and groups. Uplift capacity (including under-reamed piles) . Negative skin friction. Pile load tests. Pile integrity tests. Codal provisions. Caissons.

Laterally Loaded Piles: Analysis and Design; Foundations in Difficult soil conditions.

CVL702 Ground Improvement and Geosynthetics

3 Credits (3-0-0)

Principles of compaction, Engineering behaviour of compacted clays. Shallow stabilization with additives: lime, fly ash and cement. Deep stabilization: stone column, sand drains, prefabricated drains, lime column, soil-lime column, vibro-floatation, dynamic compaction, electro-osmosis. Grouting : permeation, compaction and jet; Dewatering systems. Geosynthetics: types and functions, materials and manufacturing processes, testing and evaluation; Reinforced soil structures: principles of soil reinforcement, application of geotextiles and geogrids in roads, walls, and embankments. Application of geotextiles, geonets and geocomposites as drains and filters. Multiple functions: railways and overlay design. Geosynthetics in environmental control: covers and liners for landfills – material aspects and stability considerations.

CVL703 Geoenvironmental Engineering

3 Credits (3-0-0)

Subsurface Contamination and Contaminant Transport; Waste disposal on Land; Waste containment in Landfills and Slurry ponds, Monitoring of subsurface contamination, Control and Remediation. Engineering Properties of waste and geotechnical reuse, erosion control, sustainability, energy geotechnics.

CVL704 Finite Element Method in Geotechnical Engineering

3 Credits (3-0-0)

Introduction. Steps in FEM. Variational Methods, Stress-deformation analysis: One-Two dimensional formulations; Three-dimensional formulations; Boundary conditions; Solution algorithms; Discretization; Use of Commercial packages. Analysis of foundations, dams, underground structures and earth retaining structures. Analysis of flow (seepage) through dams and foundations. Consolidation Analysis,

Linear and non-linear analysis. In situ stresses. Sequence construction and excavation. Joint/interface elements. Infinite elements. Dynamic analysis. Evaluation of material parameters for linear and non-linear analysis, Recent developments.

CVL705 Slopes and Retaining Structures

3 Credits (3-0-0)

Slope stability: infinite slopes; finite height slopes – Swedish method, Bishop's simplified method and other limit equilibrium methods; Stability charts; conditions of analysis – steady state, end of construction and sudden draw down; earthquake effects. Seepage: flownet in isotropic, anisotropic and layered media; entrance-exit conditions; determination of phreatic line. Earth Dams: Introduction, factors influencing design, design of components, construction, instrumentation. Road and rail embankments. Reinforced slopes. Soil nailing; Gabions. Earth Pressure: Types; Rankine's theory and Coulomb's theory; Effects due to wall friction; Graphical methods; Earthquake effects. Rigid retaining structures: Types; stability analysis. Flexible retaining structures: Types; material; cantilever sheet piles; anchored bulkheads—methods of analysis, moment reduction factors; anchorage. Reinforced soil walls: Elements and stability. Soil arching. Braced excavation: Pressure distribution in sands and clays; bottom heave. Underground structures in soils: Pipes; tunnels. Tunneling techniques.

CVL706 Soil Dynamics and Earthquake Geotechnical Engineering

3 Credits (3-0-0)

Engineering problems involving soil dynamics; Role of inertia; Theory of Vibrations: Single and two-degrees of freedom systems, vibration measuring instruments, Vibration absorption and isolation techniques; Wave propagation: elastic continuum medium and semi-infinite elastic continuum medium; Measurement of small strain and large strain dynamic soil properties: Field and Laboratory tests; Selection of design values; Machine Foundations: Design criteria for machine foundations, elastic homogeneous half space solutions, lumped parameter solutions, Codal provisions, Design of Pile-supported machine foundations; Strong Ground Motion: Measurement, characterization and estimation; Amplification theory, and ground response analysis; Liquefaction of soils: evaluation using simple methods and mitigation measures; Seismic slope stability analysis; Seismic bearing capacity and earth pressures; Codal provisions.

CVL707 Soil-Structure Interaction Analysis

3 Credits (3-0-0)

Basic Soil Models: Single parameter model - Winkler; Two parameter models - Filonenko-Borodick, Pasternak; Elastic Continuum - plane strain, plane stress, Boussinesq's problem, line load, strip load; Special models starting with elastic continuum - Vlazov, Reissner; Three parameter model - Kerr model; Evaluation of model parameters for different conditions. Beam on Winkler foundation: solutions for infinite and semi-infinite beams; Finite beams: method of initial parameters, method of superposition. Beams on Elastic continuum: Use of finite difference method, rigid and flexible beams, lift-off, non-homogeneous soil, non-linear soil, plastic yielding of soil. Raft or Mat foundations: thin rectangular plates, approximate theory of plates, circular plates. Pile on Winkler foundation: Vertically loaded pile - rigid pile, evaluation of spring stiffness, non-homogeneous soil, compressible pile; Laterally loaded pile - rigid pile, Elastic pile, standard solutions for different end conditions; Pile on elastic continuum : vertically loaded piles - rigid pile.

CVL708 Geotechnology of Waste Disposal Facilities

3 Credits (3-0-0)

Integrated waste management, Detailed design of MSW Landfills and HW Landfills including individual components, Closure of Old landfills, Expansion of old landfills, Ashponds and Tailings Ponds, Seismic Stability; Disposal of Nuclear Waste.

CVL709 Offshore Geotechnical Engineering

3 Credits (3-0-0)

Submarine soils: Origin, nature and distribution. Terrigenous and

pelagic soils. Submarine soils of India. Engineering behaviour of submarine soils: under-consolidated soils, calcareous soils, cemented soils, corals; Offshore site investigations: sampling and sampling disturbance, in situ testing, wireline technology. Offshore pile foundations for jacket type structures. Foundations of gravity structures; Foundations for jackup rigs. Anchors and breakout forces; anchor systems for floating structures. Stability of submarine slopes. Installation and stability of submarine pipelines.

CVD710 Minor Project (CEU)

3 Credits (0-0-6)

CVL710 Engineering Properties of Rocks and Rock Masses

3 Credits (3-0-0)

Introduction. Rock materials, Physical properties, Strength behaviour in uniaxial compression, tension and triaxial state. Laboratory testing methods. Stress-strain relationships. Factors influencing strength. Failure mechanism. Anisotropy. Failure criteria, Coulomb, Mohr's, Griffiths and Modified Griffiths criteria and Empirical criteria. Brittle – ductile transition, Post failure behaviour. Strength and deformation behaviour of discontinuities. Rock mass behaviour, Shear strength of jointed rocks, roughness, peak and residual strengths. Strength criteria for rock mass. Intact and rock mass classifications, Terzaghi, RQD, RSR, RMR, GSI and Q classifications, Rating, Applications. Creep and cyclic loading. Direct shear of joints in CNL, CNS conditions, Weathered rocks. Flow through intact and fissured rocks. Dynamic properties.

CVP710 Rock Mechanics Laboratory 1

3 Credits (0-0-6)

Tests and test procedures, Rock samples, Specimen preparation, Coring, cutting and lapping. Tolerance limits.

Physical properties: Water absorption, density, specific gravity, porosity, void index, electrical resistivity and sonic wave velocity tests. Mechanical Properties: Uniaxial compression, Point load index and Brazilian strength tests, Strain Measurements, Elastic properties. Effect of L/D ratio and saturation. Strength anisotropy. Shear tests: Single, double, oblique tests, punch shear, Triaxial compression tests, Direct shear test. Slake durability and Permeability tests. Compilation of test data. Classification. IS and ISRM Codal provisions.

CVL711 Structural Geology

3 Credits (3-0-0)

Origin, interior and composition of the earth. Rock cycle, Igneous, Metamorphic and Sedimentary rocks. Rock structures. Plate tectonics, Continental drift and sea floor spreading. Geological time scale. Layered formations, Attitude, true and apparent dips, topographic maps, outcrops. Measurement of attitude of formations. Folds, types of folds, classification, field study of folds, mechanics of folds, causes of folding. Joints, rock mass concept, Joint description and classification. Three point problems, Depth and thickness problems. Faults, mechanics of faulting, normal, reverse and thrusts, faults. Lineations. Foliations, Schistosity. Fault problems. Stereographic projection methods, Kinematics of joints and faults, Use of DIPS software, presentation of geological data and analysis, Applications, Scan line survey of rock joints in the field visit.

CVL712 Slopes and Foundations

3 Credits (3-0-0)

Introduction, Short-term and long-term stability. Influence of ground water, Seismic effects. Types of rock slope failures. Infinite slopes, Circular and non-circular slip surface analysis, Stability charts. Plane failure analysis. Wedge failure analysis analytical, Stereographic methods. Buckling and toppling failures, Rock falls, Landslides. Foundations: Bearing capacity, settlement and stress distribution in intact and layered rocks. Foundations of dams. Deep foundations. Tension foundations, Codal provisions. Foundation improvement. Use of appropriate software packages.

CVL713 Analysis and Design of Underground Structures

3 Credits (3-0-0)

Introduction. Types and classification of underground openings.

Factors affecting design. Design methodology. Functional aspects. Size and shapes. Support systems. Codal provisions. Analysis: Stresses and deformations around openings, Stresses and deformations around tunnels and galleries with composite lining due to internal pressure, Closed form solutions, BEM, FEM. Design: Design based on analytical methods; Empirical methods based on RSR, RMR, Q systems; Design based on Rock support interaction analysis; Observational method-NATM, Convergence-confinement method. Design based on Wedge failure and key block analysis. Design of Shafts and hydraulic tunnels. Stability of excavation face and Tunnel portals. Use of appropriate software packages.

CVL714 Field Exploration and Geotechnical Processes

3 Credits (3-0-0)

Surface and sub surface exploration methods. Aerial and remote sensing techniques, Geophysical methods, electrical resistivity, seismic refraction, applications. Rock drilling, Core samplers, Core boxes, Core orientations.

Logging, stratigraphic profile, scan line survey. Laboratory tests, report. Stresses in rocks. Stress anisotropy and stress ratio. Stress relief and compensation techniques, USBM, door stopper cells, flat jack, hydrofrac, strain rosette and dilatometers. Deformability, plate load, pressure tunnel and bore hole tests. Strength tests, insitu compression, tension and direct shear tests. Pull out tests. Borehole extensometers, piezometers, embedment gauges, inclinometers, Slope indicators, packer tests for insitu permeability, Codal provisions.

Ground improvement techniques. Compaction, Grouting, Types of grouts, technique, Rheological models. Viscous and viscoplastic flows. Spherical and radial flows, Shotcrete, Ground anchors, Rock bolts.

CVL715 Excavation Methods and Underground Space Technology

3 Credits (3-0-0)

Principles of rock breakage, explosive energy, energy balance, blasting mechanism. Types of explosives, initiators, delay devices, primer and booster selection. Blast hole design. Drilling methods and machines Blast hole timing. Pattern design, open pit and underground blasting, production, estimation and damage criteria of ground vibrations. TBM tunnelling. Factors influencing and evaluation, Excavation mechanics, Boom machines, transverse boom tunnelling machines and Robins mobile miner. Drag pick cutting, cutting tool materials and wear, disc cutters. Case studies.

Tunnels, energy storage caverns, nuclear waste disposal repositories, metros, underground chambers and defence installations. Geological considerations, layout, survey and alignment. Analysis and design methods. Construction methods. Ventilation, provisions, equipment. Control and monitoring system, services, operations and maintenance. Lighting, specifications, maintenance, emergency lighting. Power supply and distribution, Water supply and distribution. Safety provisions, localized hazards, fire hazards in highway tunnels, rapid transit tunnels. Surveillance and control system for highway tunnels. Tunnel finish.

CVL716 Environmental Rock Engineering

3 Credits (3-0-0)

Theory: Stress-strain behaviour of rocks and rock masses: Elastic, elasto-plastic, and brittle, Crack phenomena and mechanisms of rock fracture.

Temperature, pressure and water related, problems, Effect of temperature on rock behaviour. Fluid flow through intact and fissured rocks. Time dependent behaviour of rocks: Creep, Viscoelasticity and Viscoplasticity

Continuum and discontinuum theories: Equivalent material, Block and Distinct element.

Application: Waste disposal, Radioactive and hazardous wastes, repositories, location and design, VLH, VDH and KBS3 concepts. Waste container, barriers, rock structure, embedment, buffers and seals. Performance assessment, quality control and monitoring. Case histories. Hazardous Earth processes, high ground stresses, rock bursts, subsidence. Karst formations. Landslides and rock falls, slopes

stabilization, mitigation, Case studies.

Earthquakes, tectonic stresses, creep, ground motions, damage, prediction. Volcanic activity and hazard. Tsunamis. Case studies.

Thermal analysis, Thermo-mechanical analysis, thermo-hydro-mechanical analysis. Rock dynamics. Physical modelling.

CVD720 Major thesis part1

6 Credits (0-0-12)

CVS720 Independent Study

3 Credits (0-3-0)

Specific to the context of the problem decided by the supervisor.

CVL720 Air Pollution and Control

3 Credits (3-0-0)

Air-pollution; Air Pollution Effect on Plants; Air Pollution effect on Human health; Air quality monitoring; Air Pollution Meteorology; Gaussian Plume model; Urban Air Pollution; Air Pollution from Industries; Air Pollution control; Air pollution indices; standards; norms; rules and regulations; Indoor Air Pollution.

CVD721 Major Thesis Part-II

12 Credits (0-0-24)

CVL721 Solid Waste Engineering

3 Credits (3-0-0)

Solid Wastes: Origin, Analysis, Composition and Characteristics. Integrated Solid Waste Management System: Collection, Storage, Segregation, Reuse and Recycling possibilities, Transportation, Treatment/Processing and Transformation Techniques, Final Disposal. Management of: Municipal, Biomedical, Nuclear, Electronic and Industrial Solid Wastes and the rules and regulations.

CVL722 Water Engineering

3 Credits (3-0-0)

Water quality parameters-conventional contaminants and emerging contaminants; Sedimentation; Coagulation and flocculation; Filtration-mechanisms and interpretations; Ion exchange and adsorption; Disinfection; Reverse osmosis, electro dialysis, desalination.

Water treatment : Source selection process, selection of treatment chain, plant siting, Treatability studies. Design of physico-chemical unit operations.

CVL723 Wastewater Engineering

3 Credits (3-0-0)

Wastewater quality parameters, Biological processes; Microbial growth kinetics; Modeling of suspended growth systems; concepts and principles of carbon oxidation, nitrification, denitrification, methanogenesis. Biological nutrient removal; Anaerobic treatment; Attached growth reactors; decentralised wastewater treatment systems; constructed wetlands; Design of pretreatment, secondary treatment, and tertiary disposal systems. Sludge stabilization, treatment, sludge thickening, sludge drying, aerobic and anaerobic digestion of sludges; reliability and cost effectiveness of wastewater systems; Emerging contaminants in wastewater-treatment issues.

CVL724 Environmental Systems Analysis

3 Credits (3-0-0)

Introduction to natural and man-made systems. Systems modeling as applied to environmental systems. Nature of environmental systems, the model building process addressing to specific environmental problems. Strategies for analyzing and using environmental systems models. Fate and transport models for contaminants in air, water, and soil. Optimization methods (search techniques, linear programming, non-linear programming, dynamic programming) to evaluate alternatives for solid-waste management and water and air pollution control. Optimization over time. Integrated environmental management strategies addressing multi-objective and multi-stakeholder planning.

CVL725 Environmental Chemistry and Microbiology*3 Credits (1-0-4)*

Chemical equilibria and kinetics fundamentals; Acids and bases; Titrations; Acidity; Alkalinity; Buffers and buffer intensity; Chemical equilibrium calculations; pC-pH diagram; Langelier index; Solubility diagram; Oxidation and reduction reactions; Cell structure; Types of microorganisms in environment; metabolic classification of organisms; laboratory procedure for determining chemical and microbial parameters, Introduction to advanced instruments.

CVD726 Minor Project*3 Credits (0-0-6)***CVL727 Environmental Risk Assessment***3 Credits (3-0-0)*

Basic concepts of environmental risk and definitions; Human health risk and ecological risk assessment framework; Hazard identification procedures and hazard prioritization; Environmental risk zonation; Consequence analysis and modelling (discharge models, dispersion models, fire and explosion models, effect models etc). Estimation of incident frequencies from historical data, frequency modelling techniques e.g., Fault tree analysis (FTA) and Event tree analysis (ETA), Reliability block diagram. Human factors in risk analysis; Risk management & communication. Rules, regulations and conventions.

CVL728 Environmental Quality Modeling*3 Credits (3-0-0)*

Plume Rise Models; Introduction to Air Quality Modelling; Turbulence fundamentals; Basic diffusion equation; Fick's law; deterministic; numerical and statistical modeling approach; Fundamentals of Receptor modelling; Dispersion and receptor models; Fundamentals of Indoor air quality modelling techniques; Fundamentals of Water quality modeling: surface water and ground water models; Fate and transport of Conservative and non-conservative pollutants. Modelling as a tool for strategising pollution prevention and control.

CVL729 Environmental Statistics and Experimental Design*3 Credits (2-0-2)*

Introduction on environmental data, environmental statistics estimation (concentration, frequency of detection, minimum detection limit, sample size), frequency and probability distributions, inferences concerning mean and variance, confidence Interval estimation, hypotheses test, ANOVA, regression, goodness of fit, factorial experimentation, exceedance factor, intervention model, Case studies.

CVL730 Hydrologic Processes and Modeling*3 Credits (3-0-0)*

Hydrologic Cycle and its individual component processes. River Basin as a Linear Hydrologic System. Linear Theory of Hydrologic Systems. Lumped Integral and Distributed Differential modelling approaches. Transform methods of Linear Systems Analysis. Morphological attributes of watersheds and its role in runoff dynamics. Flood Routing by Lumped Hydrologic and Distributed Hydraulic approaches. Unsaturated zone Hydrology and physics of the Soil-Plant-Atmosphere Continuum. Calibration and Validation of Rainfall-Runoff models.

CVP730 Simulation Laboratory-I*1.5 Credits (0-0-3)*

Basic of Fortran 90, Fortran 95 and computing, Numerical solution of different types of partial differential equations: parabolic equation, elliptical equation, hyperbolic equation, Backwater curve analysis; Groundwater flow problems, Pipe network analysis, Unsteady channel flow.

CVS730 Minor Project (CEW)*3 Credits (0-0-6)***CVL731 Optimization Techniques in Water Resources***3 Credits (3-0-0)*

Optimization techniques commonly used in water resources planning

& management, water infrastructures, and irrigation and hydropower projects; Linear programming and duality, Network flow algorithms, Dynamic programming, Nonlinear programming, Geometric and Goal programming, Introduction to modern heuristic methods like genetic algorithm and simulated annealing, Multiobjective optimization, Applications and case studies in water resources, agriculture, environment and other areas of science & engineering.

CVP731 Simulation Laboratory-II*1.5 Credits (0-0-3)*

Simulate hydraulic, hydrologic, pipe flow, water hammer using various softwares such as Visual Mod Flow, SWAT, HYDRUS, Hytran, MIKE, Bentley Software, Fluent, HMS, SAMS.

CVL732 Groundwater Hydrology*3 Credits (3-0-0)*

Occurrence and movement of groundwater including subsurface investigations of groundwater. Flow through saturated and unsaturated media. Well Hydraulics and aquifer parameters. Pumping wells and their design, construction, monitoring and rehabilitation of wells. Recharge of groundwater by various means. Salt water intrusion and coastal aquifer hydraulics. Analog and numerical models and application of Finite Difference method to groundwater, case studies.

CVL733 Stochastic Hydrology*3 Credits (2-0-2)*

Concepts of probability and Random variables; moments and expectations; Common probabilistic distributions and estimation of parameters; goodness of fit tests; Modelling of Hydrologic High and Low Extremes, Regional Frequency Analysis, Stochastic processes and modelling of stochastic time series; Markov Chains and Probabilistic Theory of Reservoir Storages.

CVL734 Advanced Hydraulics*3 Credits (3-0-0)*

Energy and Momentum principles in open channel, Curvilinear Flows, Backwater computations, Controls, Rapidly varied flows, Spatially varied flows, Unsteady flow, Surges, Flood wave passage, Roll waves, Sediments transport, Incipient motion criteria, Resistance to flow and bed forms, Bed load theory, Stratified flows, Fluvial Systems, Industrial Hydraulics.

CVL735 Finite Element in Water Resources*3 Credits (3-0-0)*

Introduction to finite element method, Mathematical concepts and weighted residual techniques, Spatial discretization, Shape functions, Isoparametric elements, Explicit and implicit time marching schemes, Equation assembly and solution techniques, Application: Navier-Stokes equations, dispersion of pollutants into ground and surface water, Flow through earthen dams, seepage beneath a hydraulic structure, Groundwater flow in confined and unconfined aquifers.

CVL736 Soft Computing Techniques in Water Resources*3 Credits (2-0-2)*

Artificial Intelligence; Expert Systems; Artificial Neural Networks: Introduction, Training, Applications in Hydrology; Genetic Algorithms; Fuzzy Logic Systems, Fuzzy Set Theory, Predictive and Descriptive Data Mining; Classification Methods: Decision trees, NN, Bayesian, ANN, SVM, Applications; Association Analysis; Cluster Analysis - K-means, Fuzzy, Self-Organising maps; Anomaly detection; Applications in Water Resources - Forecasting, Regionalization.

CVL737 Environmental Dynamics and Management*3 Credits (3-0-0)*

Environmental property and processes, Environmental simulation models, Elements of environmental impact analysis, Impact assessment methodologies, Framework of environmental assessment, Environmental impact of water resources projects, Assessment of hydrological hazards, Environmental management, Case studies.

CVL738 Economic Aspects of Water Resources Development

3 Credits (3-0-0)

Economics of water and development, Basic economic concepts, Financial analysis of a project, Pricing concepts, Benefit-cost-sensitivity analysis, Capital budgeting and cost allocation, Economics of natural resources management, Hydro economic model, Hydro-economic risk assessment, Economics of river restoration, Economics of trans-boundary water resources management.

CVL740 Pavement Materials and Design of Pavements

4 Credits (3-0-2)

Pre-requisite(s): M.Tech: Nil; B.Tech: Instructor's permission

Components of pavement structure and its requirements; Materials used in pavement construction: aggregate, Portland cement, asphalt, Portland cement concrete, asphalt concrete; Aggregates: production, properties, testing procedures, gradation and blending; Portland cement based materials: mixture design, production, properties, testing, construction; Asphalt binder: refining process, properties, testing procedures, grading systems; Asphalt concrete mixture design: fundamentals of mix design procedure, mixture volumetrics, current mix design procedures; Production and construction practices; Stresses and strains in pavement system: traffic, environment considerations; Design of pavements: new, overlay; Pavement performance; Drainage consideration.

CVL741 Urban and Regional Transportation Planning

4 Credits (3-0-2)

Pre-requisite(s): M.Tech: Nil; B.Tech: Instructor's permission

Fundamentals of transportation planning. Components of transportation system and their interaction. Historical development and current status of techniques used in travel demand forecasting; Economic Theory of travel demand forecasting; trip generation, trip distribution, mode choice, traffic assignment models. Integration of landuse transport models. Comparison and evaluation of various models. Simultaneous travel demand models: Parameter Estimation and Validation. Travel Data collection and use of surveys. The role of transportation planning in the overall regional system. Methodology and models for regional transportation system, planning, implementation framework and case studies. Applications to passenger and freight movement in urban area. Implications for policy formulations and analysis.

CVL742 Traffic Engineering

4 Credits (3-0-2)

Pre-requisite(s): M.Tech: Nil; B.Tech: Instructor's permission

Introductory concepts of traffic engineering, road user and vehicle characteristics, Road way geometric characteristics, traffic stream characteristics, and traffic flow theory basics. Statistical applications in traffic engineering. Traffic data collection methods - speed, volume, travel time and delay studies. Parking studies. Highway safety and statistics. Capacity analysis of freeway and multilane highways - fundamental concepts, freeway segment analysis, two-way highways. Intersections concepts of intersection control, intersection layout, signalization basics, signal timing. Analysis of signals and coordination under undersaturated and oversaturated conditions.

CVL743 Airport Planning and Design

3 Credits (3-0-0)

Pre-requisite(s): M.Tech: Nil; B.Tech: Instructor's permission

Overview of air transport; Forecasting demand-passenger, freight; Aircraft characteristics; Airport planning-requirements site selection, layout plan; Geometric design of runway, taxiway and aprons; Airport capacity-airside, landside; Passenger terminal-functions, passenger and baggage flow; Airport pavement design and drainage; Parking and apron design; Air cargo facilities; Air traffic control lighting and signing; Airport safety; Environmental impact of airports; Airport financing and economic analysis.

CVL744 Transportation Infrastructure Design

3 Credits (2-0-2)

Pre-requisite(s): M.Tech: Nil; B.Tech: Instructor's permission

Transportation infrastructure: components, structural and functional requirements, capacity, level of service; Highway infrastructure: grade intersections, rotaries, interchanges; Railway infrastructure: trackbed design, grade-crossing design, embankment, retaining walls; Drainage infrastructure: culverts, bridges; Pedestrian infrastructure: pedestrian sidewalks, foot bridges; Miscellaneous: bus and truck terminals, parking facilities, guard rails, tunnels, underpasses;

CVL745 Modeling of Pavement Materials

3 Credits (2-0-2)

Pre-requisite(s): M.Tech: Nil; B.Tech: Instructor's permission

Role of constitutive modeling; Laboratory testing in relation to constitutive modeling: elastic modulus, resilient modulus, complex modulus, creep, rheological tests; Introduction to continuum mechanics: strain tensor, stress tensor, isotropy, anisotropy, constitutive relationships; Factors affecting material behavior: temperature, rate, time, confining pressure; Unbound materials: soil, aggregate; Bound materials: binding using asphalt, water, lime, polymer, fly ash, cement; Constitutive models: unbound materials, bound materials; Field performance of pavement materials: fatigue, rutting, temperature issues, moisture damage, permeability; Transfer functions to relate laboratory performance with field performance.

CVL746 Public Transportation Systems

3 Credits (3-0-0)

Pre-requisite(s): M.Tech: Nil; B.Tech: Instructor's permission

This course discusses the role of urban public transportation modes, focusing on bus and rail systems. Operational and Technological characteristics are described, along with their impacts on capacity, service quality, and cost. Current practice and methods for data collection and analysis, performance evaluation, route and network design, frequency determination, and vehicle and crew scheduling are covered. Main topics include: Transit System; Estimation of Transit Demand; Route planning techniques; Bus Scheduling; Transit Corridor identification and planning; Mass Transport Management Measures; Integration of Public Transportation Modes. Public transport Infrastructure; Case Studies. Multimodal Transportation Systems.

CVL747 Transportation Safety and Environment

3 Credits (3-0-0)

Pre-requisite(s): M.Tech: Nil; B.Tech: Instructor's permission

Scientific management techniques in planning, implementing, and evaluating highway safety programs, strategies to integrate and amplify safety in transportation planning processes., multidisciplinary relationships necessary to support effective traffic safety initiatives. Traffic Safety as public health problem, Injury indices and costing , emergency care, pollution inventory in urban areas, environment and safety standards.

CVL750 Intelligent Transportation Systems

3 Credits (3-0-0)

Pre-requisite(s): M.Tech: Nil; B.Tech: Instructor's permission

Introduction to Intelligent Transportation Systems (ITS); ITS Organizational Issues, the fundamental concepts of Intelligent Transportation Systems (ITS) to students with interest in engineering, transportation systems, communication systems, vehicle technologies, transportation planning, transportation policy, and urban planning. ITS in transportation infrastructure and vehicles, that improve transportation safety, productivity, environment, and travel reliability. Mobile device applications of ITS such as trip planners, ETA s of public transit vehicles.

CVD753 Minor Project in Transportation Engineering

3 Credits (0-0-6)

Pre-requisite(s): M.Tech.: Nil

CVS754 Independent Study

3 Credits (0-0-6)

*Pre-requisite(s): Instructor's permission***CVD756 Minor Project in Structural Engineering**

3 Credits (0-0-6)

The course content will be decided by the concerned faculty member (supervisor) who will be assigning the research project to the students registered for this course.

CVL756 Advanced Structural Analysis

3 Credits (3-0-0)

Matrix methods for 3-D skeletal structures: force and displacement methods including analysis using substructures, static condensation. Computational aspects including in plane rigidity of slab, non-prismatic members, and shear deformation effects. Non-linear analysis: second order and elastoplastic analysis. Energy approaches. Analysis of plates and singly curved shells.

CVP756 Structural Engineering Laboratory

3 Credits (0-0-6)

Concrete: Concrete mix-design Evaluation of stress-strain response of plain, self-compacting and high-performance concrete; Behaviour of RC members under axial, flexure, shear torsion, and interaction; Behavior of slabs, Non-destructing testing. Response of structures and its elements against extreme loading events. Model testing: Models of plates, shells, and frames; Free and forced vibrations; Evaluation of dynamic modulus; Beam vibrations; Vibration isolation; Shear wall building model; Time and frequency-domain study. Smart materials; Photogrammetry for Displacement Measurement; Vibration Characteristics of RC Beams using Piezoelectric Sensors etc.

CVS756 Independent Study (CES)

3 Credits (0-0-6)

Course content will be decided by the concerned faculty member of structural engineering.

CVD757 Major Project Part-I (CES)

9 Credits (0-0-18)

*Pre-requisite(s): programme core Credits+minimum 24 credits***CVL757 Finite Element Methods in Structural Engg.**

3 Credits (2-0-2)

Review of principles of virtual work and minimum potential energy. Elements of theory of elasticity. Finite element (FE) techniques for linear and static problems. Developing various types of finite elements: 1-D, 2-D, and 3-D. Formulating displacement and shape functions. Variational and weighted residual techniques. Higher order/ isoparametric formulation for truss, beam, frame, plate, and shell elements. Numerical solution procedures and computational aspects. Applications to structures such as dams, frames, shear walls, grid floors, rafts etc. Algorithms for FE problem solving and commercial software modeling issues. Application of FE methods to solve thermal problems.

CVD758 Major Project Part-II (CES)

9 Credits (0-0-18)

*Pre-requisite(s): CVD757 must be passed***CVL758 Solid Mechanics in Structural Engineering**

3 Credits (3-0-0)

Pre-requisite(s): UG/Dual- 120 credits

Introduction; Historical developments; Theory of stress; Kinematics; Isotropic/ anisotropic linear elastic solids; Axioms of constitutive equations; Finite isotropic elasticity; Hypo/ hyperelasticity; Hardening plasticity; Viscoelasticity; Boundary Value Problems (BVPs); Plane elasticity; Polar coordinates; Torsion and bending of prismatic bars with general section; Elastic wave propagation; Current trends.

CVL759 Structural Dynamics

3 Credits (3-0-0)

Theory of structural dynamics and vibration analysis. Free and forced vibration of single degree of freedom (SDOF) systems, load regimes and response to harmonic, periodic, impulsive, and general dynamic loading. Response of SDOF to earthquake and response spectrum concept. Damping in structures and its evaluation. Free and forced vibration of lumped multi degree of freedom (MDOF) structures. Methods for obtaining natural frequencies and mode shapes. Normal mode theory; mode combination rules; dynamic response evaluation. Force excited and base excited dynamical systems. Time domain analysis using numerical integration scheme. Free and forced vibration of continuous systems. Frequency domain analysis of dynamical systems. Introduction to advanced topics in structural dynamics.

CVL760 Theory of Concrete Structures

3 Credits (3-0-0)

Introduction: Historical developments, Material properties; Cracked concrete members under flexural moment and axial force; Deformations and collapse; M-P interaction. Beams without stirrups under flexural and torsional shear: Morsch and Regan theories; Skew-bending theory. Beams with stirrups under flexural and torsional shear: Plane and space truss analogies, Modified compression field theory, Unified theory, P-M-V-T interaction; Strut and tie model; Cracking: Bond slip, Development length, Tension stiffening, Durability detailing; Serviceability: Elastic, creep and shrinkage deformations; Elastic analysis: Redistribution of moments; Plastic analysis: Inelastic and hysteretic behaviour, Limit design, Confined concrete: Ductility detailing requirements; Buckling of columns; Concrete slabs: Yield line theory, Strip Theory; Reliability and safety: Limit state design method, Target reliability; Current trends: Constitutive modelling, Capacity design, Finite element analysis.

CVL761 Theory of Steel Structures

3 Credits (3-0-0)

Structural steel: Classifications, Grades, Behavioural characteristics, Plasticity and hardening; Material models: Simple, Rigid, Power function, Smooth hysteretic; Design methodology: Allowable, Limit state, Ultimate; Methods of analysis including second-order effects; Plastic design: Plate instabilities, Local buckling, Section classifications; Structural stability: Global buckling, Member and frames under axial and combined loading; Sway and non-sway frames; Design of members under combined bending, shear and torsion; Connections: Simple, Semi-rigid, Rigid; Plates girders: Simple post-critical theory, Tension-field theory, Section design, Stiffener requirements; Gantry girder; Grillage foundation; Earthquake-resistant design and detailing; Fire-resistant design; Fatigue-resistant design.

CVL762 Earthquake Analysis and Design

3 Credits (3-0-0)

Seismology; Seismic Risk and Hazard; Soil Dynamics and Seismic Inputs to Structures; Response Spectrum Analysis (RSA); Special Analysis; Nonlinear and Push-Over Analysis; Dynamic Soil-Structure Interaction (SSI); Earthquake Resistant Design Philosophy; Performance Based Earthquake Engineering; Code Provisions for Seismic Design of Structures; Retrofitting and Strengthening of Structures; Concept of Base Isolation Design and Structural Vibration Control; Advanced Topics in Earthquake Engineering.

CVL763 Analytical and Numerical Methods for Structural Engineering

3 Credits (3-0-0)

Introduction: Mathematical foundations of structural theory. Linear algebra: vector spaces and linear transformations. Linear differential equations and function spaces. Partial differential equations; Elliptic, parabolic and hyperbolic PDEs. Nonlinear differential equations. Gaussian Elimination; Factorization Techniques - LU, Cholesky; Iterative Methods of Solution of Linear Simultaneous Equations. Properties of Eigenvalues and Eigenvectors; Similarity Transforms; Diagonalization and Numerical Techniques to Compute Eigenvalues - Vector Iteration, QR algorithm, Jacobi Method. Time Marching Schemes (Step by Step Solutions); Euler's Method; Runge Kutta

Method; Newmark Beta Method. Numerical Solution of Boundary Value Problems - Finite Difference Method, Explicit and Implicit Approaches; Method of Weighted Residuals, Galerkin's Method. Numerical Integration: Gauss- Legendre Method, Newton-Cotes Method. Regression Analysis and Curve Fitting. Applications of mathematical and numerical methods to static, dynamic and stability analysis of elastic structures and cables.

CVL764 Blast Resistant Design of Structures

3 Credits (2-0-2)

Blast Engineering: Explosion Phenomena, Shock Front, Fragmentation, Waves, Ground Shock, and Interaction with Structures; Structural Analysis for Impulsive Loading; Pressure-Impulse (PI) Diagrams; Material Behaviour under High Strain-Rate of Loadings; Blast Resistant Design of Structures; Performance-Based Blast Design; Progressive Collapse; Anti-Terrorism Planning and Design of Facilities; Blast Retrofitting; Indian/ International Standards and Codes of Practice; Numerical Analysis Tools for Blast Analysis using Finite Element (FE) Software and Hydrocodes.

CVL765 Concrete Mechanics

3 Credits (3-0-0)

Introduction; Rheological modelling of fresh concrete; Flowing concrete; Mechanics of hardened concrete: Failure criteria; Constitutive equations; Elasto-plasticity, visco-elasticity, fatigue, damage mechanics and fracture; Mechanics of hydrating concretes, Durability Mechanics, Transport processes; Drying shrinkage; Micromechanics, Numerical and analytical homogenisation, poromechanics, Crystalline growths and internal microstresses.

CVL766 Design of Bridge Structures

3 Credits (3-0-0)

Introduction, historical/ magnificent bridges; Site Selection, Planning, and Type of Bridges, Loads and Forces; Code Provisions for Design of Steel and Concrete Bridges; Analysis Methods, Grillage Analogy; Theories of Lateral Load Distribution and Design of Superstructure: Slab Type, Beam-Slab, and Box Type; Distribution of Externally Applied and Self-Induced Horizontal Forces among Bridge Supports in Straight, Curved, and Skewed Decks; Continuous Type and Balanced Cantilever Type Superstructure; Temperature Stresses in Concrete Bridge Deck; Different Types of Foundations: Open, Pile, and Well Foundations; Choice of Foundation for Abutments and Piers; Design of Abutments, Piers, Pile/ Pier Caps; Effect of Differential Settlement of Supports; Bridge Bearings; Expansion Joints for Bridge Decks; Vibration of Bridge Decks; Parapet and Railings for Highway Bridges; Construction Methods; Segmental Construction of Bridges; Inspection and Maintenance of Bridges; Health Monitoring and Evaluation of Existing Bridges; Bridge Failure: Case Studies.

CVL767 Design of Fiber Reinforced Composite Structures

3 Credits (3-0-0)

Introduction; Types of structural fibers: matrix, fiber and interface; Fiber reinforced concrete (FRC); High-performance concrete; Stress transfer, Bond, Pull-out, Toughening mechanism; Fracture mechanics; Modeling of tensile and flexural behaviours; Behaviour under compression; Shear failure theory; Behaviour under seismic loading; Composite structural design: Design spirals, Selection Criteria configurations; Laminate design; Mathematical analysis of laminates; Design of single skin panels, Design of composite stiffeners.

CVL768 Design of Masonry Structures

3 Credits (3-0-0)

Introduction and Historical Perspective; Masonry Materials; Masonry Design Approaches; Overview of Load Conditions; Compression Behavior of Masonry; Masonry Wall Configurations; Distribution of Lateral Forces; Flexural Strength of Reinforced Masonry Members: In-plane and Out-of-plane Loading, Interactions; Structural Wall; Columns and Pilasters; Retaining Wall; Pier and Foundation; Shear Strength and Ductility of Reinforced Masonry Members; Prestressed Masonry; Stability of Walls; Coupling of Masonry Walls, Openings, Columns, Beams; Elastic and inelastic analysis; Modelling Techniques; Static Push-Over Analysis and use of Capacity Design Spectra.

CVL769 Design of Tall Buildings

3 Credits (3-0-0)

Structural systems and general concepts of tall buildings; Various methods of structural analysis; Gravity systems for steel, concrete, and composite buildings; Lateral systems for steel, concrete, and composite buildings; Interaction of frames and shear walls; Simultaneous and sequential loading; Differential shortening of columns; P-Δ effects; Effect of openings; Foundations and foundation-superstructure interaction; Wind/ earthquake effects and design for ductility; Damping systems; Asymmetric structures and twisting of frames.

CVL770 Prestressed and Composite Structures

3 Credits (2-0-2)

Introduction; Need, Advantages, and Disadvantages; High Strength Materials; Pretensioning and Post-Tensioning Methods; Prestressing Methods; Prestressing Systems and Devices; Camber, Deflections, and Cable Profiles/ Layouts; Load-Balancing; Codes and Standards; Prestressed Concrete Members - Flexure, Shear, Torsion Behaviors; Design Methods and Code Provisions; Strain Compatibility Method; Pressure/ Thrust Line; Pre-Tensioning; Grouted/ Bonded and UngROUTED/ Unbonded Post-Tensioning; Partial Prestressing; Bursting Stresses; Anchorage Zone (End Block Design); Transmission and Transfer Length; De-Bonding and Draping of Prestressing Tendons; Camber, Deflection, and Ductility; External Prestressing; De-Compression; Losses in Prestress; Bearing and Bond Stresses; Case Studies of Prestressed Concrete Bridge Design and Practices.

Need of Composite Construction; Analysis of Indeterminate and Composite Structures; Design Methods for Composite Beams, Slabs, Columns, Box-girders, Shear Studs etc.

CVC771 Seminar in Construction Technology and Management-I

0 Credits (0-0-2)/Compulsory Audit

CVD771 Minor Project (CEC)

3 Credits (0-0-6)

CVL771 Advanced Concrete Technology

3 Credits (3-0-0)

Hydration of cements and microstructural development, Mineral additives, Chemical admixtures, Rheology of concrete, Creep and relaxation, Shrinkage, cracking and volume stability, deterioration processes, special concretes, Advanced characterisation techniques, sustainability issues in concreting, Modelling properties of concrete.

CVP771 Construction Technology Laboratory

1.5 Credits (0-0-3)

Tests related to quality control at site, in-situ tests, tests related to damage and deterioration assessment, performance monitoring of structures.

CVS771 Independent Study (CEC)

3 Credits (0-0-6)

CVC772 Seminar in Construction Technology and Management-II

0 Credits (0-0-2)/Compulsory Audit

CVD772 Major Project Part-I (CEC)

9 Credits (0-0-18)

CVL772 Construction Project Management

3 Credits (3-0-0)

Introduction to construction project management - CPM, PERT, PDM, LOB. Scope management, WBS, PDRI. Time and cost management, material related management - purchase & inventory control, time-cost-resource optimization, quality, safety - planning & control. Labor productivity variations, productivity improvement - work study. Measuring project progress & performance - EVA & ES. Identification of risks and impact. Management Information systems.

CVP772 Computational Laboratory for Construction Management*1.5 Credits (0-0-3)*

Introduction to construction project models - analytical and numerical. Application software for project planning, scheduling & control. Programming exercises for estimation, network planning and control, LP in construction.

MATLAB Programming in linear and non-linear programming.

CVD773 Major Project Part-II (CEC)*12 Credits (0-0-24)***CVL773 Quantitative Methods in Construction Management***3 Credits (3-0-0)*

Introduction and concepts of probability and statistics, Linear programming, Transportation and assignment problems. Dynamic programming, Queuing theory, Decision theory, Games theory. Simulations applied to construction, Modifications and improvement on CPM/PERT techniques.

CVL774 Construction Contract Management*3 Credits (3-0-0)*

Professional Ethics, Duties and Responsibilities of Parties. Owner's and contractor's estimate, Bidding Models and Bidding Strategies, Qualification of Bidders, Tendering and Contractual procedures, Indian Contract Act 1872, Definition of Contract and its Applicability, Types of Contracts, Clauses in Domestic and International Contracts - CPWD, MES, FIDIC, AIA, NEC, JCT, etc. Contract Administration, Delay Protocol, Change Orders Analysis, Claim Management and Compensation, Disputes and Resolution Techniques, Arbitration and Conciliation Act 1996, Arbitration Case Studies.

CVL775 Construction Economics and Finance*3 Credits (3-0-0)*

Engineering economics, Time value of money, discounted cash flow, NPV, ROR, PI. Basis of comparison, Incremental rate of return, Benefit-cost analysis, Replacement analysis, Break even analysis. Depreciation and amortization. Taxation and inflation, Evaluation of profit before and after tax. Risks and uncertainties and management decision in capital budgeting. Working capital management, financial plan and multiple source of finance. Budgeting and budgetary control, Performance budgeting. Profit & Loss, Balance Sheet, Income statement, Ratio analysis, Appraisal through financial statements, International finance, forward, futures and swap. Practical problems and case studies.

CVD776 Minor Project (CET)*3 Credits (0-0-6)***CVL776 Construction Practices and Equipment***3 Credits (3-0-0)*

Form work design and scaffolding, slipform and other moving forms, Shoring, Reshoring, and Backshoring in multistoreyed Building construction.

Prestressing, Steel and composites construction methods: Fabrication and erection of structures including heavy structures, Prefab construction, Industrialized construction, Modular coordination. Special construction methods: High rise construction, Bridge construction including segmental construction, incremental construction and push launching techniques.

Factors affecting selection of equipment - technical and economic, Analysis of production outputs and costs, Characteristics and performances of equipment for major civil engineering activities such as Earth moving, erection, material transport, pile driving, Dewatering, and Concreting.

CVS776 Independent Study (CET)*3 Credits (0-0-6)***CVD777 Major Project Part-I (CET)***9 Credits (0-0-18)***CVL777 Building Science***3 Credits (3-0-0)*

Introduction to environmental features relevant to functional design. Their measures description and quantification. Periodic nature of variation of environmental descriptors. Heat exchange of building with environment under diurnal periodic variation temperature and modelling. Estimation of hourly internal temperature through CIBS method. Thermal Design philosophy and optimization for decision variables such as shape, orientation, envelope properties etc. Purpose of ventilation, wind and stack effect as driving force. Design for desired flow and indoor velocity. Fundamentals of acoustics, Sound ion free field and enclosure. External and Internal air borne noise control. Protection against structure borne noise. Lighting principles and daylighting. Day light factor, and design for desired illumination and glare free lighting.

CVD778 Major Project Part-II (CET)*12 Credits (0-0-24)***CVL778 Building Services and Maintenance Management***3 Credits (3-0-0)*

Concepts of functional design of building for fire protection, design of lift systems for optimum service. Building service system design. Control and intelligent buildings, HVAC, hot and cold water services, waste water handling system, electrical services, building maintenance management.

CVL779 Formwork for Concrete Structures*3 Credits (3-0-0)*

Requirements and selection for Formwork, Formwork Materials, and Accessories, Horizontal and Vertical Formwork Supports; Formwork Design Concepts, Illustration of Formwork system for Foundations, walls, columns, slab and beams and their design, Formwork for Shells, Domes, Folded Plates, Overhead Water Tanks, Natural Draft Cooling Tower. Formwork for Bridge Structures, Flying Formwork such as Table form, Tunnel form. Slipform, Formwork for Precast Concrete, Formwork Management Issues pre award and post award, Formwork failures-causes and Case Studies in Formwork Failure, Formwork issues in multi-story building construction.

CVD800 Major Project Part-I*6 Credits (0-0-12)***CVL800 Emerging Topics in Geotechnical Engineering***3 Credits (3-0-0)*

A course which will vary from year to year to study new and exciting developments in the broad spectrum of Geotechnical and Geoenvironmental Engineering. The course will also focus on new offshoots of Geotechnical and Geoenvironmental Engineering.

CVP800 Geoenvironmental and Geotechnical Engg. Lab*3 Credits (0-0-6)*

Engineering properties and compaction characteristics of waste - coal ash, mine tailings. Permeability of clays and bentonite amended soils. Physical, Mechanical and Hydraulic Testing of Geosynthetics Landfill liner and cover: Evaluation of shear strength parameters of various Interfaces and design. Project based laboratory for evaluation of engineering properties of soils for design of embankments.

CVS800 Independent Study*3 Credits (0-0-6)***CVD801 Major Project Part-II***12 Credits (0-0-24)***CVL801 Constitutive Modelling in Geotechnics***3 Credits (3-0-0)*

Introduction: fundamental relations, models and soil mechanics. Elasticity: Isotropic, anisotropic, soil elasticity. Failure criteria for soils. Plasticity and yielding: yielding of clays, yielding of sands, slip line

fields, introduction to upper and lower bounds, selected boundary value problems. Elasto-plastic model for soils: elastic volumetric strains, plastic volumetric strains, plastic hardening, plastic shear strains, plastic potentials, flow rule. Cam clay model: critical state line, shear strength, stress-dilatancy, index properties, prediction of conventional soil tests. Applications.

CVD810 Major Project Part-I (CEU)

6 Credits (0-0-12)

CVL810 Emerging Topics in Rock Engineering and Underground Structures

3 Credits (3-0-0)

Advanced and state-of-the-art rock engineering topics.

CVP810 Rock Mechanics Laboratory-II

3 Credits (0-0-6)

Pre-requisite(s): Rock Mechanics Lab-I CVP710

Project planning, Schedule and cost assessment, DPR and GD for Major projects, Field visit, Sample collection, Scanline survey and seismic survey, Rock characterization, Determination of physical and mechanical properties of rocks, Analysis of slopes using GEOSLOPE and Analysis of tunnels using Phase2, both using the material properties determined through laboratory tests. Design of slopes and tunnels.

CVS810 Independent Study (CEU)

3 Credits (0-0-6)

CVD811 Major Project Part-II (CEU)

12 Credits (0-0-24)

CVL811 Numerical and Computer Methods in Geomechanics

3 Credits (2-0-2)

Pre-requisite(s): CVL704 or Equivalent

Introduction to Numerical Methods, ODEs, PDEs, Equation solution techniques, Root finding techniques, Fourier Series, Types of geotechnical boundary value problems, Numerical modeling, Numerical solution schemes, pros and cons, Programming tools-FORTRAN, MATLAB, MATHCAD, Development of programming flowchart.

Simplified and advanced constitutive models and their calibration: Elastic Models, Elasto-plastic Models, Formulation of Elasto-Plastic Stiffness Matrix, Governing equations of elastoplasticity, Rock and Soil constitutive models.

Integration of stress-strain equations, Concepts of verification and validation, Selection of model input parameters, Integration of load-displacement relations, Integration of seepage, consolidation and heat conduction equations, Sturm-Liouville problem, Solution of seepage, consolidation, heat conduction and Sturm-Liouville equations using finite difference and finite element programming methods, Comparison with commercially available software results.

CVL818 Design of Plates and Shells (PG)

3 Credits (2-1-0)

Prismatic folded plate systems. Shell equations. Approximate solutions. Analysis and design of cylindrical shells. Approximate design methods for doubly curved shells.

CVL819 Concrete Mechanics (PG)

3 Credits (3-0-0)

Introduction; Rheological modelling of fresh concrete; Constitutive equations; Nonlinear elasticity, plasticity, visco-elasticity and fracture mechanics of hardened concrete; Confinement and ductility; Moisture diffusion; Drying shrinkage; Solid and structural mechanics of reinforced concrete, Skew bending, modified compression field and unified theories of R.C. beams under bending, shear and torsion; Bond-slip and phenomenon of cracking in reinforced concrete; Static and dynamical analysis of R.C. Structures; Trends.

CVL820 Environmental impact assessment

3 Credits (3-0-0)

Planning and Management of Environmental Impact Studies. Impact indentation methodologies: base line studies, screening, scoping, checklist, networks, overlays. Prediction and assessment of impacts on the socio-economic environment. Environmental cost benefit analysis. Decision methods for evaluation of alternatives. Case Studies. Environmental impact assessment at project level, regional level, sectoral level, and policy level. Sustainable development; Environmental policy in planned, mixed and market economies. Preventive environmental management.

CVP820 Advanced Air Pollution Laboratory

3 Credits (1-0-4)

Monitoring of TSP using HVS, Monitoring of PM2.5 using cyclone based sampler, Size segregated particle collection and data analysis using histogram, inversion program, Personal exposure assessment, determination of count and geometric mean diameter, determination of chemical species in air samples, Determination of emission factors of particle and gases for combustion sources, Determination of TVOC; Determination of indoor air quality parameters, determination of Bioaerosol; Monitoring and analysis of meteorological parameters.

CVL821 Industrial Waste Management and Audit

3 Credits (3-0-0)

Industrial Wastes: Nature and characteristics, Prevention and Control, Tools for clean processes: reuse, recycle, recovery, source reduction, raw material substitution, process modification, Flow sheet analysis, Energy and resources audit, Waste audit, emission inventory and waste management hierarchy for process industries, Zero discharge, Environmental indicators, Industrial ecology and ecoparks, rules and regulations, Case studies: Dairy, Fertilizer, Distillery, Pulp and Paper, Iron and steel, Metal plating, Refineries, Thermal power plants, etc.

CVP821 Advanced Water and Wastewater Laboratory

3 Credits (1-0-4)

Principles of instrumentation and application for water quality parameters measurements, Operation of batch scale models for various processes: Activated sludge process, Disinfection, Settlers, Coagulation, Filtration, Anaerobic digestion, Adsorption. Design and operation of treatability studies and microbial growth kinetics, microbial toxicity and bioaccumulation studies. Micropollutants detection; Package programmes for water and wastewater conveyance, treatment and disposal.

CVL822 Emerging Technologies for Environmental Management

3 Credits (3-0-0)

Contemporary micro and macro environmental issues of importance, global environmental and resource sharing issues, international treaties and protocols. Emerging contaminants and emerging technologies for waste management, Case studies of environmental pollution and innovative management strategies. Environmental technology transfer, Non-conventional Energy, Emission trading, Adaptation to climate change.

CVL823 Thermal Techniques for Waste Management

3 Credits (3-0-0)

Fundamentals of Thermodynamics, Heat Transfer and Combustion as applied to Waste Incineration. Introduction to fuels, reactor design, fluidization engineering and furnace technology. Combustion of gaseous, liquid and solid fuels. Wastes as fuels. Low, medium and high temperature thermal treatment techniques, Energy recovery, pollution control techniques for thermal facilities, Design of thermal treatment facilities with pollution control devices.

CVL824 Life Cycle Analysis and Design for Environment

3 Credits (3-0-0)

Engineering products and processes : Environmental health and safety, Product life cycle stages, Material toxicity, pollution, and degradation, Environmentally conscious design and manufacturing approaches,

Sustainable development and industrial ecology. System life-cycles from cradle to reincarnation, Product life-extension, Organizational issues. Pollution prevention practices, Manufacturing process selection and trade-offs. Design for Environment : Motivation, concerns, definitions, examples, guidelines, methods, and tools. Recyclability assessments, Design for recycling practices. Re- manufacturability assessments, Design for Remanufacture / Reuse practices. Industrial ecology and Eco-industrial parks. Eco-Labels and Life-Cycle analysis (LCA): LCA methodology, steps, tools and problems, Life-Cycle Accounting and Costing. ISO 14000 Environmental Management Standards. New business paradigms and associated design practices.

CVL825 Fundamental of Aerosol: Health and Climate Change

3 Credits (3-0-0)

This course will introduce the students with fundamentals of aerosols, Difference in gas and particle motion in the air, physio-chemical and optical properties of individual and mixed particles, behaviour of non-spherical particles, thermodynamic properties of aerosol, particle formation, application of aerosol fundamentals and properties in research and industries, impact of aerosol properties on indoor/outdoor air quality, health and climate.

CVL826 Quantitative microbial risk assessment

1 Credit (1-0-0)

Pathogens, Occurrence and fate in environment, Human exposure pathways, Microbial exposure dose estimation, Infection and dose-response modeling, Risk of infection estimation, Uncertainty estimation.

CVL827 Environmental Implications of Engineered Nanomaterials

2 Credits (2-0-0)

Engineered nanomaterials, Occurrence of nanomaterials in environment, Fate of nanomaterials in environment, Exposure pathways-model development and parameter estimation, Dose-response effects of nanomaterials to humans and aquatic species; dose-response modeling and risk estimation of nanomaterials exposures; Risk management of nanomaterials pollution; Prioritization of nanomaterials for monitoring; Regulatory guidelines for implications assessment and pollution regulations; Emerging challenges for long-term management of nanomaterials exposure.

CVL828 Water Distribution and Sewerage Network Design

3 Credits (3-0-0)

Planning for water supply sources and demand assessment. Water demand forecasting. Types of water distribution systems. Intermittent and continuous water supply systems. Design and analysis of Water mains. Design and analysis of water distribution system. Analysis of water deficient systems. Optimal design of water distribution systems. On-line monitoring of water quality parameters. Retrofitting of the existing water supply systems.

Planning for wastewater conveyance system in urban areas. Combined and separate systems for storm and sewage. Design and analysis of wastewater conveyance system. Optimal design of wastewater conveyance systems. Operation and maintenance issues. Retrofitting of the sewerage system.

CVL830 Groundwater Flow and Pollution Modeling

3 Credits (3-0-0)

Subsurface processes and concepts for groundwater resources evaluation, Unsaturated zone properties: Soil moisture levels, Retention curves, Flow through unsaturated porous media, Multiphase flows, infiltration and Wetting front, Groundwater contamination, Sources and causes of groundwater pollution, Pollution dynamics, Hydrodynamics dispersion, Adsorption, Biodegradation, Radioactive decay, Reactive processes, Multiphase contamination, NAPLs, VOCs, Site specific groundwater quality problems in Indian context, Numerical models, Finite difference methods, Numerical modeling of steady and transient flows in saturated and unsaturated domain, Contaminant transport modeling, Application of FEM and BIEM in

groundwater modeling, Regional aquifer simulation, Contaminated groundwater systems and their rehabilitation, Development and optimization based management of aquifer systems, Stochastic models, Random field concepts in groundwater models; Application of emerging techniques to groundwater management.

CVS830 Independent Study (CEW)

3 Credits (0-3-0)

CVD831 Major Project Part-I

6 Credits (0-0-12)

CVL831 Surface Water Quality Modeling and Control

3 Credits (3-0-0)

River hydrology and derivation of Stream Equation, Derivation of Estuary equation, Distribution of water quality in rivers and estuaries. Physical and Chemical characteristics of Lakes, Finite Difference steady state river, estuary and Lake models., Dissolved Oxygen models in rivers, estuaries and Lakes, Fate of Indicator Bacteria and pathogens in water bodies. Basic Mechanism of Eutrophication, Lake phytoplankton models, eutrophication in rivers and estuaries. Elements of Toxic substance analysis.

CVD832 Major Project Part-II

12 Credits (0-0-24)

CVL832 Hydroelectric Engineering

3 Credits (3-0-0)

Hydropower development schemes and their various configurations, Planning for firm Capacities, Peak Load and Base Load configurations, Role of and Regulation of Hydropower development in a mixed hydro-steam system, Governing of Hydropower systems; study of hydraulic transients in Penstocks. Surge analysis and dynamics of Surge tanks. Micro hydro power developments.

CVV832 Approaches for Contaminated Site Characterization

1 Credit (0.8-0.2-0)

The course will effectively present a sync between the formalization of groundwater contamination problem with the interplay of data requirements, to be obtained from site characterization, and mathematical modelling. For this, in the course modeling approached and geophysical methods from a very bare fundamentals and up to the recent most development will be presented. Subsequently, the usefulness and criticality of quality field-data and modeling methods will be explored with a goal of an efficient contaminated site management. Implementations of field data and numerical methods will be discussed using simple to very complex case-studies.

CVL833 Water Resources Systems

3 Credits (3-0-0)

Water Resources Planning Purposes and Objectives, Multi-component, multi-user, multi-objective and multi-purpose attributes of an Integrated Water Resources System, Economic basis for selection of a Plan Alternative.

Introduction to Linear Programming and applications in Water Resources Engineering.

Irrigation Planning and Operation Models, Linear, Deterministic Integrated Water Resources Management Model on River Basin Scale, River Basin Scale Integrated Stochastic Water Resources Planning and Management Models.

CVL834 Urban Water Infrastructure

3 Credits (3-0-0)

Urban water cycle, Urban water infrastructures - water supply, storm water drainage, sanitation, sewerage and wastewater conveyance infrastructures, Water supply and sewerage network hydraulics, SCADA systems, Sustainable urban designs, Methodologies for assessing sustainability of urban water infrastructures, Emerging sustainable materials and design procedures for water supply and sewerage pipelines, Hydraulic performance and structural strength, chemical resistance and resilience characteristics of emerging

materials based water and sewer pipelines, Rehabilitation and augmentation technologies for water supply and sewerage networks, Analytic hierarchy process and optimization techniques for arriving at the best appropriate rehabilitation/augmentation technology, Urban water management, Rain water harvesting, Managed aquifer recharge, Constructed/engineered wetlands, Sprinkler and drip irrigation, Water use efficiencies, Effect of water management practices on urban water infrastructure, hydrology and groundwater regime, Surface and subsurface mapping of water supply and sewerage networks, Structural safety and mitigating plans against natural and human caused threats.

CVL835 Eco-hydraulics and Hydrology

3 Credits (3-0-0)

Classification of Hydro environmental systems, governing equations for open surface flow domains, pollutant transport equations in hydro-environmental flow systems, computational methods and solution techniques. Study of ecological descriptors, numerical ecology, multi-objective definitions of environmental flows, Hydrologic indices for e-flows and river health assessment. Riverine habitat characterization and habitat simulation models. Anthropogenic triggers for changes in riverine habitat.

CVL836 Advanced Hydrologic Land Surface Processes

3 Credits (3-0-0)

Introduction: Eco-hydro-climatology; Climate System; Climate, weather and Climate Change; Water, Energy and Carbon Cycle; Overview of Earth's Atmosphere: Heat-Balance of Earth Atmosphere System; Temporal Variation of Air temperature; Introduction to Atmospheric Thermodynamics: First and second law of thermodynamics, Adiabatic process and adiabatic lapse rate, Entropy, Clausius-Clapeyron Theory, Introduction to cloud microphysics and cloud droplet formation process, Cloud liquid water content, entrainment, warm and cold cloud. Hydrologic Cycle: Global water balance; Precipitation and Weather, Forms of Precipitation; Atmospheric Stability; Monsoon; Global Wind Circulation; Indian Summer Monsoon Rainfall. Climate Variability: Floods, Droughts, Climate Extremes. Climate Change: Introduction; Causes and Modeling of Climate Change, Climate Models, Downscaling; IPCC Scenarios; Commonly used Statistical Methods in Hydro-climatology: Trend Analysis; EOF, PCA; Canonical Correlation; Statistical Downscaling; Ecological Climatology: Leaf energy fluxes and leaf photosynthesis; Ecosystem and vegetation dynamics; Coupled climate vegetation dynamics, Carbon cycle climate feedbacks.

CVL837 Mechanics of Sediment Transport

3 Credits (2-0-2)

Introduction; Equations of Particle Motion particle in a moving fluid, collision with the bed, diffusion of turbulence; Macroscopic View of Sediment Transport – bedload, suspended load; Threshold Condition for Sediment Motion – Critical stress for flow over a granular bed, Shields diagram; Mechanics of Bedload Transport: Bagnold hypothesis of bedload transport, bedload transport relations; Mechanics of Suspended Sediment Transport; Total load transport; Descriptive Analysis of Bedforms – introduction of bedform mechanics, dunes, antidunes, ripples, bars; Stability Analysis of Bedforms; Mechanism of transportation of materials by fluid flow through pipeline; Rheology and classification of complex mixtures; Fundamentals of two-phase flow; Phase separation and settling behaviour; Flow of non-Newtonian fluids through pipes: Turbulent flows of Complex mixtures, Slurry pipeline transportation, Design methods.

CVL838 Geographic Information Systems

3 Credits (2-0-2)

What is GIS. Geographic concepts for GIS. Spatial relationships, topology, spatial patterns, spatial interpolation. Data storage, data structure, non-spatial database models. Populating GIS, digitizing, data conversion. Spatial data models, Raster and Vector data structures and algorithms. Digital Elevation Models (DEM) and their application. Georeferencing and projection systems, GIS application areas, Spatial analysis, quantifying relationships, spatial statistics, spatial search.

CVL839 Hydrologic Applications of Remote Sensing

3 Credits (2-0-2)

Principles of remote sensing, Remote sensing platforms and data acquisition systems, Wavebands, Radiometric quantities, Spectral reflectance and spectral signature, Interaction of electromagnetic radiation with land surface features, hydrosphere and atmosphere, Data capture for simulation of land surface processes, Photographic and image interpretation, Satellite image processing, Earth surface features inventory, Geomorphology, Landuse classification, Landuse planning and landcover mapping, Flood plain mapping and flood plain zoning, Remote sensing applications in water resources, agriculture, geology and environmental monitoring, Applications in snow and glacier studies, Snow line, Ice cover, Snow-pack properties, Integrated use of remote sensing and GIS, Database preparation and Decision support analysis, Estimation of damages due to hydrologic extremes and preparation of contingency plans, Case studies.

CVL840 Planning and Design of Sustainable Transport Systems

3 Credits (3-0-0)

Pre-requisite(s): M.Tech: CVL741; B.Tech: Instructor's permission

Sustainable Transportation Planning and Design including: Consideration of bicycles, pedestrian, mass transit modes, and private vehicles like cars and two wheelers as well as how these modes interrelate. Applicability at varying scales, from a downtown street to a neighborhood to a regional network Case studies are discussed from different parts of the world. Various indicators for measuring sustainability index of transport system including public health, resource consumption, local and global pollution and equity considerations are discussed.

CVL841 Advanced Transportation Modelling

3 Credits (2-0-2)

Pre-requisite(s): M.Tech: CVL741; B.Tech: Instructor's permission

Systems Approach to Travel demand models, Trip generation Models Using Different Statistical techniques, Trip distribution, Discrete Choice Logit, Nested Logit and other Models, Network Assignment, Traffic Assignment Using User Equilibrium and Systems Optimization Techniques, Revealed preference and Stated Preference surveys, Analysis of Ranked and Rated data, Demand models for Nonmotorised transport and Public Transport systems.

CVL842 Geometric Design of Roads

3 Credits (2-0-2)

Pre-requisite(s): M.Tech: CVL741, CVL742; B.Tech: CVL261 and one TE elective

Introduction to basic road geometric design elements and methodology - design philosophy and design techniques; Design controls - human, vehicle and speed related factors. Road vehicle performance - road vehicle dynamics - tractive and resisting forces. Braking forces. Theoretical and practical stopping distances. Elements of geometric design - cross section elements; Horizontal Alignment - tangents, curves, transitions, superelevation; Vertical Alignment - grades and curves; Coordination of Horizontal and Vertical Alignment. Design of Intersections at-grade- design principles, channelization, roundabouts, Interchanges- types, warrants, lane balancing; Road side safety- hazards and clear zone concept, traffic safety barriers, impact attenuation.

CVL844 Transportation Infrastructure Management

3 Credits (3-0-0)

Pre-requisite(s): M.Tech: CVL740; B.Tech: Instructor's permission

Transportation infrastructure components; Deterioration phenomena; Effect of external factors like environment, traffic loading, material properties on deterioration mechanisms; Evaluation techniques to evaluate damage: destructive, nondestructive; Performance

models: development, calibration; Infrastructure management systems; Serviceability of condition and safety; Decision making and optimization techniques applied to infrastructure management; Life cycle cost analysis techniques.

CVL845 Viscoelastic Behavior of Bituminous Materials 3 Credits (3-0-0)

Pre-requisite(s): M.Tech: CVL740; B.Tech: Instructor's permission

Overview of material behavior-elastic, plastic, viscoelastic, Viscoplastic response; Aging; Issues in representative volume element; Mechanical analogs for viscoelastic response; Fundamental viscoelastic response-creep compliance, relaxation, complex modulus; Interconversion techniques to obtain fundamental viscoelastic responses; Time-temperature superposition; linear viscoelastic constitutive equations; Elastic-viscoelastic correspondence principle; Predicting material behavior-undamaged, damaged state conditions, Introduction to nonlinear viscoelasticity, Viscoelastoplastic behavior, fracture mechanics.

CVL846 Transportation System Management

3 Credits (3-0-0)

Pre-requisite(s): M.Tech: CVL741 and CVL742; B.Tech: Instructor's permission

Transportation systems - resource management, approaches to funding. Asset and demand management - Integrated network design, changing travel behaviour, optimising asset management, role of technology; Optimizing the investment outcomes - movement of freight and passenger, traffic. Land use planning and urban growth management - land use and its effect on infrastructure and efficient network operations. Congestion, systemic congestion improvement and system-wide efficiency, Transit oriented development, safety considerations; evaluation of strategies; case studies.

CVL847 Transportation Economics

3 Credits (3-0-0)

Pre-requisite(s): M.Tech: CVL741; B.Tech: Instructor's permission

Overview of Transportation Economics; Transportation Investments and economic Development. Basics of Engineering economics, marginal analysis, opportunity cost, shadow price, money value of time, discounted cash flow, NPV, ROR, benefit-cost analysis. Road User Costs; Public transportation economics; Social Cost of Transportation; Cost of congestion, pollution, traffic accidents. Taxation, regulations, financing Transport Systems; Legal framework for transportation sector, case studies.

CVL849 Traffic Flow Modelling

3 Credits (3-0-0)

Pre-requisite(s): CVL742

Descriptors of traffic flow: Macroscopic and Microscopic, time, space and generalized measurement regions. Cumulative plots. Traffic Flow models - General classification and typology. Macroscopic Flow Models - continuity equation, LWR model, higher order models, numerical schema, Mesoscopic Flow Models - gas kinetic theory, Microscopic and Submicroscopic Flow Models - car following and lane changing; Pipes and forbes models; General motors-Gazis-Herman-Rothery (GHR) models, Stability analysis, macro-micro bridge. Modelling at Junctions/Intersections; Un-signalized and Signalized; Roundabouts; Pedestrian Modelling - normal and panic movements; variations across infrastructure; Simulation - simple and complex traffic conditions.

CVL850 Transportation Logistics

3 Credits (3-0-0)

Pre-requisite(s): M.Tech: CVL742 else Instructor's permission (including B.Tech)

Evolution of freight and logistics; Interrelationships between

society, environment and freight transport; Survey methodologies to understand freight movement; Cost measurement: Production, Holding, Transportation, Handling; Effect of internal and external variables on cost; Demand forecasting; Inventory planning and management; Transportation and distribution network: Design, Reverse Logistics. Development, Management; Ware house operations; Pricing: Perishable, seasonal demand, uncertainty issues; Vehicle routing: One-to-one distribution, One-to-many distribution, Shortest path algorithm, Quickest time algorithm; Logistics information system; Designing and planning transportation networks; City logistics.

CVL851 Special Topics in Transportation Engineering

3 Credits (3-0-0)

Pre-requisite(s): CVL740 or CVL741 or CVL742 or Instructor's permission

Course details shall be announced by the instructor at the time of offering of the course. The lectures will be supplemented by reading materials. The assessment will be based on a combination of assignments, quizzes, and term papers and tests.

CVS852 Advanced Topics in Transportation Engineering

3 Credits (0-0-6)

Pre-requisite(s): CVL740, CVL741, CVL742

This is an advanced course for M.Tech. Transportation engineering program where students will study a specialized topic within transportation engineering (including but not limited to transportation planning, traffic engineering and pavement engineering). The topic shall be announced by instructor at the beginning. The performance of student in this course will be evaluated through presentation(s) and report(s) made by student during the registered term.

CVD853 Major Project Part-I

9 Credits (0-0-18)

Pre-requisite(s): CVL740, CVL741, CVL742

CVD854 Major Project Part-II

12 Credits (0-0-24)

Pre-requisite(s): CVL740, CVL741, CVL742

CVL856 Strengthening and Retrofitting of Structures

3 Credits (3-0-0)

Structural assessment, damage under accidental and cyclic loads, cracking in structures, evaluation of damage, analysis of existing structures, compression, flexural and shear strengthening, strengthening using laminates, strengthening using prestressing, bracing and stiffening of structures, maintenance of retrofitting, design codes for retrofitting of structures, retrofitting of steel structures, retrofitting of masonry structures.

CVL857 Structural Safety and Reliability

3 Credits (3-0-0)

Fundamentals of Set Theory and Probability; Probability Distribution, Regression Analysis, Hypothesis Testing. Stochastic Process and Its Moments; Probability Distributions; Concepts of Safety Factors, Safety, Reliability and Risk Analysis; First Order and Second Order Reliability Methods; Simulation Based Methods; Confidence Limits and Bayesian Revision of Reliability; Reliability Based Design; System Reliability; Examples of Reliability Analysis of Structures.

CVL858 Theory of Plates and Shells

3 Credits (3-0-0)

Thin and thick plate theories. Bending of long rectangular plate to a cylindrical surface. Prismatic folded plate systems. Pure and symmetric bending of plates. Small and large deflections of plates. Special and approximate methods in theory of plates. General theory of cylindrical shells. Shell equations. Approximate solutions of plates and shells

equations. Analysis and design of cylindrical shells. Approximate design methods for doubly curved shells. Stress analysis methods in spherical shells. Spherical shell of constant thickness. Symmetrical bending of shallow spherical shells. Conical shells.

CVL859 Theory of Structural Stability

3 Credits (3-0-0)

Introduction: Buckling of steel and concrete structures; Conservative and non-conservative loads. Elastic buckling of columns and beam-columns: Static, dynamical and energy-based approaches. Viscoelastic and elastoplastic buckling. Torsional buckling. Flexural-torsional and lateral buckling. Plate and frame buckling. Imperfection sensitivity; Post-buckling theory. Snap-through. Dynamic stability: Divergence, flutter and parametric resonance. Nonlinear dynamical systems theory; Bifurcations. Recent trends.

CVL860 Advanced Finite Element Method and Programming

3 Credits (2-0-2)

Pre-requisite(s): CVL757

Finite element method (FEM) to solve complex structural engineering problems. Various types of finite elements (FE) considering nonlinear material models; constitutive laws; hybrid elements. Strong and weak form representation and solutions. FEM for dynamic problems: consistent mass matrix, vibration of bars, beams, and plate elements. FEM for buckling problems: geometric matrix, buckling of struts, and plate elements. FE modeling and analysis of complex structures: 3-D frames, shear walls, bridges, cooling towers, continua etc. Computational aspects: meshing, convergence, singularity, etc. Interpretation of results. Comparison with other methods.

CVL861 Analysis and Design of Machine Foundations

3 Credits (2-0-2)

General design requirements, general dynamics of machine foundations for rotating and reciprocating machines, determination of soil properties, modelling, analysis and design of block/frame type foundations, specific details for machines applying impulsive loads, compressors and turbo-generators, detailed dynamic analysis and modes of vibration for frame type foundations, techniques for vibration isolation, practical case studies, codal requirements, construction aspects of machine foundations.

Laboratory : Instrumentation aspects in terms of sensors and data acquisition systems, measurement of dynamic soil parameters, measurement of vibration related parameters, vibration isolation, computational aspects related to frame type foundations including dynamic analysis.

CVL862 Design of Offshore Structures

3 Credits (3-0-0)

Rudiments of offshore engineering; sea spectra; wave theories; wave-structure interaction. Design of offshore platforms: introduction, fixed and floating platforms. Buoyed structures/ articulated towers; tension-leg platform (TLP); Marine risers; compliant and non-compliant structures; offshore pipelines and risers; Steel, concrete, and hybrid platforms. Buoys and mooring system design; Design criteria and code provisions. Environmental loading. Wind, wave and current loads. Loads and stability during handling and towing. Introduction to stochastic dynamics of ocean structures considering different sea spectra. Soil-structure interaction (SSI): beam on Winkler foundation (p-y curve approach). Dynamic analysis of SPAR platforms. Fatigue analysis of fixed and floating offshore structure: stress concentration, S-N curves. Foundations: site investigations, gravity, jacket platforms, hybrid platforms. Piled foundation and behavior under dynamic loading. Static and dynamic analysis of platforms and components. Dynamic analysis using software: response of fixed type offshore structures, articulated towers, single leg and multi-legged towers.

CVL863 General Continuum Mechanics

3 Credits (3-0-0)

Introduction: Field and particle theories in physics. Historical

development of continuum mechanics-A basic engineering science. Classical theories: Stress and kinematics. Elasticity, Viscoelasticity and Elastoplasticity; Newtonian fluids.

Continuum thermomechanics; Classius-Duhem Inequality; Thermodynamics with internal variables. Constitutive equations; Axioms for simple materials; Frame indifference; Finite elasticity; Hyper/hypoelasticity; Non-Newtonian fluids.

Polar and nonlocal materials; Materials of differential/gradient type; Configurational mechanics; Biomechanics; Nanomechanics. Theories of conduction and diffusion; Electromagnetism. Coupled fields: Thermoelasticity and electromagnetoelasticity; MHD; Chemomechanics. Intermediate problems; Statistical continuum theories; Relativistic continuum mechanics; Materials models for luminiferous Aether.

Rational methodology and realism; Current trends.

CVL864 Structural Health Monitoring

3 Credits (2-0-2)

Concept of structural health monitoring, sensor systems and hardware requirements, global and local techniques, computational aspects of global dynamic techniques, experimental mode shapes, damage localization and quantification, piezo-electric materials and other smart materials, electro-mechanical impedance (EMI) technique, adaptations of EMI technique.

Laboratory: Sensor installation and diagnostics, mode shape extraction, location and quantification of damage using global dynamic techniques, damage detection using electro – mechanical impedance technique, remote monitoring.

CVL865 Structural Vibration Control

3 Credits (3-0-0)

Pre-requisite(s): CVL759

Introduction; Types and classifications; Control theories; Optimal stiffness distributions for building type structures; Role of damping in controlling motion; Active and semi-active systems; Tuned mass dampers - single/ multiple; Quasi-static active control; Passive control: viscous, visco-elastic, friction, hysteretic dampers, base isolation; Nonlinear modeling; Dynamic feedback control; Neural network based control systems; Design for buildings, bridges, power plants, and other structures; Current trends and performance-based design.

CVL866 Wind Resistant Design of Structures

3 Credits (3-0-0)

Pre-requisite(s): CVL759

Causes and types of wind. Atmospheric boundary layer and turbulence. Wind velocity measurements and distribution. Bluffbody aerodynamics, random vibrations, and spectral analysis. Along wind and across wind response considering vortex shedding of tall buildings, towers, and slender structures. Vortex induced vibrations of slender structures. Wind-Induced lock-in excitation of tall structures. Buffeting response prediction subjected to random load. Aeroelastic phenomena. Turbulence modeling. Gust buffeting and fluttering effect on structures. Vibration of cable supported bridges and power lines due to wind effects. Wind pressure on cooling towers. Design of cladding and wind damping devices. Wind tunnel simulations and tornado effects.

CVL869 Probabilistic Structural Dynamics

3 Credits (3-0-0)

Pre-requisite(s): CVL759/AML733/APL734

Overlap(s) with: CVL857, MCL733

Concepts of set theory and probability, random variables and function of random variables, theory of random process, stationary and non-stationary process, expected values, moments, spectral properties of random process, response of linear systems to random excitations, time and frequency domain analysis, SDOF and MDOF systems, structural failure under random vibrations, crossing rates, distribution of local/extreme peaks, first passage probability, application to earthquake and wind engineering, introduction to nonlinear systems, Effect of Parameter Uncertainty, Monte-Carlo simulation.

CVL871 Durability and Repair of Concrete Structures**3 Credits (3-0-0)**

Chemical composition of concrete, permeability and transport processes, corrosion of reinforcement and prestressing steel in concrete, carbonation, chloride attack, alkali-silica reaction, freeze-thaw attack, sulphate attack, acid attack, effect of fire and high temperatures and seawater attack, cracking, weathering, biological processes, non-destructive testing, repairs, protection and retrofitting, durability based design of structures.

CVL872 Infrastructure Development and Management**3 Credits (3-0-0)**

Introduction to Indian Infrastructure. Govt. initiatives through various five year plans.

Overview of various sectors of infrastructure and SEZ.

Infrastructure procurement through Public-Private-Partnership. Sector-wise differences in policies, Concession agreement, Selection procedure of concessionaires, Issues in financial closure, Stakeholder management.

Financial Models, Risk management, Environmental Impact Assessment, Case studies.

CVL873 Fire Engineering and Design**3 Credits (3-0-0)**

(A) Fire engineering: fundamentals of fire science, fire dynamics, hazard mitigation, and safety; codes, standards, rules and fire safety regulations; thermodynamics, thermofluids, heat and mass transfer; human behavior in fire and urban planning; fire testing methods for materials; large-scale fire testing. "Fire protection" - current methods in fire safety engineering; mechanics of repair; mitigation of fire damage by due design, and construction; industrial fire safety. Passive fire protection: analyzing the thermal effects of fires on buildings and designing structural members. Introduction to active fire protection.

(B) Structural fire engineering: fire behavior and scenarios, heat transfer to the structure, structural response and stability under thermo-mechanical loads; fire safety design; mechanical properties of structural materials at elevated temperatures; fire response of steel, concrete, fiber reinforced polymers, high-performance materials etc.; computational procedures to predict structural behavior under fire conditions; structural fire resistance based on theoretical/ empirical relationships; performance-based fire engineering; strengthening/ repair of structures.

CVL874 Quality and Safety in Construction**3 Credits (3-0-0)**

Introduction to safety. Types of injuries, Factors affecting safety, Strategic Planning for safety provisions. Personal & Structural safety

- Safety consideration during construction, demolition and during use of equipment. Recording injuries and accident indices. Method statement, SOPs, PPE, Inspections, Investigations. Site safety programmes - JSA, JHA, Root cause analysis, meetings, safety policy, manuals, training & orientation. Safety legislation regard to violation. Introduction to quality, assurance, control and audit. Regulatory agent - owner, designer, contractor. Strategic Planning and control of quality during design and construction, Quality tools in construction projects, Customer satisfaction and QFD, Quantitative techniques in quality control, Quality assurance during construction, Inspection of materials and machinery. Assessing quality. Teachings/findings of Gurus - Concept and philosophy of TQM, 6 Sigma, ISO Certification. IS codes and standards regard to quality & safety.

CVL875 Sustainable Materials and Green Buildings**3 Credits (3-0-0)**

Introduction and definition of Sustainability. Carbon cycle and role of construction material such as concrete and steel, etc. CO₂ contribution from cement and other construction materials. Construction materials and indoor air quality. No/Low cement concrete. Recycled and manufactured aggregate. Role of QC and durability. Life cycle and sustainability. Components of embodied energy, calculation of embodied energy for construction materials. Exergy concept and primary energy. Embodied energy via-a-vis operational energy in conditioned building. Life Cycle energy use. Control of energy use in building, ECBC code, codes in neighboring tropical countries, OTTV concepts and calculations, features of LEED and TERI Griha ratings. Role of insulation and thermal properties of construction materials, influence of moisture content and modeling. Performance ratings of green buildings. Zero energy building.

CVL876 Digital Design and Construction**3 Credits (2-0-2)**

Fundamentals of BIM – terminology, CAD & BIM. IFCs, schemas, interoperability, parametric modeling. BIM-based design process and analysis - design coordination. BIM-based construction process – 4D, 5D, nD BIM. BIM-based operation issues – facility management. Drivers and barriers in BIM adoption, BIM global practices.

Automation in design and construction, virtual experiments – augmented reality, virtual reality, use of sensors in construction. Robots in construction, autonomous robots, 3D printing technology in construction.

Drones for Construction monitoring, Internet of Things, Smart Manufacturing, etc.

CVD895 MS Research Project**36 Credits (0-0-72)**

Department of Computer Science and Engineering

COL100 Introduction to Computer Science

4 Credits (3-0-2)

Organization of Computing Systems. Concept of an algorithm; termination and correctness. Algorithms to programs: specification, top-down development and stepwise refinement. Problem solving using a functional style; Correctness issues in programming; Efficiency issues in programming; Time and space measures. Procedures, functions. Data types, representational invariants. Encapsulation, abstractions, interaction and modularity. Identifying and exploiting inherent concurrency. Structured style of imperative programming. Introduction to numerical methods. At least one example of large program development.

COL106 Data Structures & Algorithms

5 Credits (3-0-4)

Pre-requisite(s): COL100

Introduction to object-oriented programming through stacks queues and linked lists. Dictionaries; skip-lists, hashing, analysis of collision resolution techniques. Trees, traversals, binary search trees, optimal and average BSTs. Balanced BST: AVL Trees, 2-4 trees, red-black trees, B-trees. Tries and suffix trees. Priority queues and binary heaps. Sorting: merge, quick, radix, selection and heap sort, Graphs: Breadth first search and connected components. Depth first search in directed and undirected graphs.

Disjkrá's algorithm, directed acyclic graphs and topological sort. Some geometric data-structures.

COL202 Discrete Mathematical Structures

4 Credits (3-1-0)

Overlaps with: MTL180

Propositional logic, Predicate Calculus and Quantifiers; Proof Methods; Sets, functions, relations, Cardinality, Infinity and Diagonalization; Induction and Recursion; Modular Arithmetic, Euclid's Algorithm, primes, Public Key Cryptography; Polynomials, finite fields and Secret Sharing; Coding Theory: Error correcting codes, Hamming codes, Hamming bound; Basic Counting - Pigeon hole principle; Advanced Counting - recurrence relations, generating functions, inclusion-exclusion; basic information theory, entropy, Kraft's inequality, mutual information, lower bounds; Probability - sample space, conditional probability, expectation, linearity of expectation, variance, Markov, Chebychev, probabilistic methods; Graph Theory - Eulerian, Hamiltonian & planar graphs, edge and vertex coloring.

COL215 Digital Logic & System Design

5 Credits (3-0-4)

Pre-requisite(s): COL100, ELL101

Overlaps with: ELL201

The course contents can be broadly divided into two parts. First part deals with the basics of circuit design and includes topics like circuit minimization, sequential circuit design and design of and using RTL building blocks. The second part is focused on ASIC style system design and introduces VHDL, FPGA as implementation technology, synthesis steps as well as testing techniques. Course ends with introducing the challenges of embedded design where software is becoming integral to all devices. The laboratory assignments are a key component of this course and requires students to design and implement circuits and sub-systems on FPGA kits covering almost all the topics covered in the lectures.

COL216 Computer Architecture

4 Credits (3-0-2)

Pre-requisite(s): ELL201

Overlaps with: ELL305

History of computers, Boolean logic and number systems, Assembly language programming, ARM assembly language, Computer arithmetic, Design of a basic processor, Microprogramming, Pipelining, Memory system, Virtual memory, I/O protocols and devices, Multiprocessors.

COL226 Programming Languages

5 Credits (3-0-4)

Pre-requisite(s): COL106

Overlaps with: COL765

Value and state oriented paradigms. Translation. Notions of syntax and semantics of programming languages; introduction to operational/ natural semantics of functional and imperative languages. Data abstractions and control constructs; block-structure and scope, principles of abstraction, qualification and correspondence; parameter passing mechanisms; runtime structure and operating environment; practical and implementation issues in run-time systems and environment; abstract machines; features of functional and imperative languages; the un-typed and simply-typed Lambda calculus, type systems for programming languages including simple types and polymorphism; objects; classes and inheritance in object-oriented languages. Interactive programming and interfaces. The laboratory activities will involve building a variety of small interpreters for core languages in various paradigms. Tools such as lex and yacc will be introduced for front-end analysis.

COP290 Design Practices

3 Credits (0-0-6)

Pre-requisite(s): COL 106

The contents may differ each year depending on the instructor. The course should involve 2-3 large programming projects done in groups of 2-4.

COD300 Design Project

2 Credits (0-0-4)

Basic design methodology – introduction to the steps involved, Familiarization with software practices, tools and techniques, software project involving conceptualization, design analysis, implementation and testing using the tools and techniques learnt.

COD310 Mini Project

3 Credits (0-0-6)

Design/fabrication/implementation work under the guidance of a faculty member. Prior to registration, a detailed plan of work should be submitted by the student to the Head of the Department for approval.

COR310 Professional Practices (CS)

2 Credits (1-0-2)

EC - 60

The course would consist of talks by working professionals from industry, government and research organizations. It may also include site visits to various organizations.

COS310 Independent Study (CS)

3 Credits (0-3-0)

EC - 60

Research oriented activities or study of subjects outside regular course offerings under the guidance of a faculty member. Prior to registration, a detailed plan of work should be submitted by the student to the Head of the Department for approval.

COP315 Embedded System Design Project

4 Credits (0-1-6)

Pre-requisite(s): COL215, COL216 or equivalent courses

Students working in small groups of four to six are expected to deliver in one semester on an innovative solution for problems/ challenges that are typical to India and perhaps other developing countries. The students would have to go through the full cycle of specification, design and prototyping/building a concept demonstrator. Key component of the assessment would be through a public demonstration of their solution.

Learning to work in groups as well as planning and delivering a large task are other expected learnings.

COL331 Operating Systems

5 Credits (3-0-4)

*Pre-requisite(s): COL106 COP290**Overlaps with: ELL405*

Primary UNIX abstractions: threads, address spaces, file system, devices, inter process communication; Introduction to hardware support for OS (e.g., discuss x86 architecture); Processes and Memory; Address Translation; Interrupts and Exceptions; Context Switching; Scheduling; Multiprocessors and Locking; Condition Variables, Semaphores, Barriers, Message Passing, etc.; File system semantics, design and implementation; File system Durability and Crash recovery; Security and Access Control.

COL333 Principles of Artificial Intelligence

4 Credits (3-0-2)

*Pre-requisite(s): COL106**Overlaps with: COL671, COL770, ELL789*

Philosophy of artificial intelligence, problem solving, search techniques, constraint satisfaction, game playing (minimax, expectiminimax), automated planning, knowledge representation and reasoning through logic, knowledge representation and reasoning through fuzzy logic and Bayesian networks, Markov decision processes, machine learning, neural networks, reinforcement learning, soft computing, introduction to natural language processing.

COL334 Computer Networks

4 Credits (3-0-2)

*Pre-requisite(s): COL106, COL216**Overlaps with: ELL402*

Students will be exposed to common network algorithms and protocols, including physical layer modulation (analog AM/FM, digital ASK/FSK/PSK), encoding (NRZ, Manchester, 4B/5B), link layer framing, error control, medium access control (TDMA, FDMA, CSMA/CA, CSMA/CD), bridging, SDN, addressing (IPv4/v6), name resolution (DNS), routing (DV, LS, protocols RIP, OSPF, BGP), transport protocols (TCP), congestion avoidance (window based AIMD), and application design models (client-server, P2P, functioning of HTTP, SMTP, IMAP). Programming assignments will be designed to test network application design concepts, protocol design towards developing error detection and correction methods, efficient network utilization, and familiarization with basic tools such as ping, trace route, wires hark.

COL341 Fundamentals of Machine Learning

4 Credits (3-0-2)

*Pre-requisite(s): COL106, MTL106**Overlaps with: ELL409, ELL784*

Supervised Learning Algorithms: 1. Logistic Regression 2. Neural Networks 3. Decision Trees 4. Nearest Neighbour 5. Support Vector Machines 6. Naive Bayes. ML and MAP estimates. Bayes' Optimal Classifier. Introduction to Graphical Models. Generative Vs. Discriminative Models. Unsupervised learning algorithms: K-Means clustering, Expectation Maximization, Gaussian Mixture Models. PCA and Feature Selection, PAC Learnability, Reinforcement Learning. Some application areas of machine learning e.g. Natural Language Processing, Computer Vision, applications on the web. Introduction to advanced topics such as Statistical Relational Learning.

COL351 Analysis and Design of Algorithms

4 Credits (3-1-0)

*Pre-requisite(s): COL106**Overlaps with: MTL342, COL702*

Checking 2-edge, 2-node and strong connectivity using DFS, Strongly connected components. Greedy algorithms, minimum spanning trees (Prim/Kruskal), Union-find data structure. Matroids. Divide and conquer algorithms. Polynomial multiplication, DFT and FFT. Dynamic Programming, All pairs shortest paths (Bellman-Ford, Floyd Warshall). s-t flows, Ford-Fulkerson, Edmonds-Karp, applications of maxflow Intractability, NP-completeness, Polynomial time reductions. String

matching, KMP and Rabin-Karp. Universal hashing and applications. Geometric algorithms like convex hulls, multidimensional data structures, plane sweep paradigm.

COL352 Introduction to Automata & Theory of Computation

3 Credits (3-0-0)

Pre-requisite(s): COL202

Regular Languages, Finite Automata, equivalence, minimization, Myhill-Nerode Theorem, introduction to non-determinism, Context free grammars, Pushdown automata, equivalence and applications. Turing machines, Recursive and Recursively enumerable sets, non-determinism, RAMs and equivalence, Universal Turing Machines, undecidability, Rice's theorems for RE sets, Post machines, Basics of Recursive function theory. Equivalence, Church's thesis, computational complexity, space and time complexity of Turing Machines, Relationships, Savage's theorem, Complexity classes, Complete problems, NP-completeness, Cook-Levin theorem.

COL362 Introduction to Database Management Systems

4 Credits (3-0-2)

Pre-requisite(s): COL106

Data models (ER, relational models, constraints, normalization), declarative querying (relational algebra, datalog, SQL), query processing/optimization (basics of indexes, logical/physical query plans, views) and transaction management (introduction to concurrency control and recovery). Overview of XML data management, text management, distributed data management. Course project to build a web-based database application.

COL380 Introduction to Parallel & Distributed Programming

3 Credits (2-0-2)

*Pre-requisite(s): COL106, COL351, COL331**Overlaps with: COL730*

Concurrency, Consistency of state and memory, Parallel architecture, Latency and throughput, Models of parallel computation, performance metrics and speedup, Message-passing and Shared-memory programming paradigms, Communication networks and primitives, Concepts of Atomicity, Consensus, Conditions and Synchronization, Security, Fault tolerance, Replication of state and memory.

COD492 B.Tech. Project Part-I

6 Credits (0-0-12)

*Pre-requisite(s): EC 100**Overlaps with: COD490*

This course is part-1 of a large project and is designed for CSE B.Tech. students seeking department specialization. This project is done individually, or sometimes in small groups, under the supervision of one or more faculty member of the computer science department. This project spans also the course COD494. Hence it is expected that the problem specification and the milestones to be achieved in solving the problem are clearly specified. Students not seeking specialization may take this course if they are interested in the COD490-COD492 sequence.

COD494 B.Tech. Project Part-II

8 Credits (0-0-16)

Pre-requisite(s): COD492, EC 100

The student(s) who work on a project are expected to work towards the goals and milestones set in COD492. At the end there would be a demonstration of the solution and possible future work on the same problem. A dissertation outlining the entire problem, including a survey of literature and the various results obtained along with their solutions is expected to be produced.

COL632: Introduction to Database Systems

4 Credits (3-0-2)

Pre-requisite(s): COL106 OR Equivalent

Overlap with: COL362

Data models (ER, relational models, constraints, normalization), declarative querying (relational algebra, datalog, SQL), query processing/optimization (basics of indexes, logical/physical query plans, views) and transaction management (introduction to concurrency control and recovery). Overview of XML data management, text management, distributed data management. Course project to build a web-based database application.

COL633: Resource Management in Computer Systems

4 Credits (3-0-2)

Pre-requisite(s): COL106 OR Equivalent

Overlap with: COL331, EEL405

Primary UNIX abstractions: threads, address spaces, filesystem, devices, interprocess communication; Introduction to hardware support for OS (e.g., discuss x86 architecture); Processes and Memory; Address Translation; Interrupts and Exceptions; Context Switching; Scheduling; Multiprocessors and Locking; Condition Variables, Semaphores, Barriers, Message Passing, etc.; Filesystem semantics, design and implementation; Filesystem Durability and Crash recovery; Security and Access Control

COL 671: Principles of Artificial Intelligence:

4 Credits (3-0-2)

Pre-requisite(s): COL106 OR Equivalent

Overlap with: COL333, COL770, ELL789

Problem solving, search techniques, control strategies, game playing (minimax), reasoning, knowledge representation through predicate logic, rule based systems, semantics nets, frames, conceptual dependency. Planning. Handling uncertainty: probability theory, Bayesian Networks, Dempster-Shafer theory, Fuzzy logic, Learning through Neural nets - Back propagation, radial basis functions, Neural computational models - Hopfield Nets, Boltzman machines. PROLOG programming. Expert Systems, Soft computing, introduction to natural language processing.

COL 672: Computer Networks

4 Credits (3-0-2)

Pre-requisite(s): COL106 OR Equivalent

Overlap with: COL334, ELL402

Students will be exposed to common network algorithms and protocols, including physical layer modulation (analog AM/FM, digital ASK/FSK/PSK), encoding (NRZ, Manchester, 4B/5B), link layer framing, error control, medium access control (TDMA, FDMA, CSMA/CA, CSMA/CD), bridging, SDN, addressing (IPv4/v6), name resolution (DNS), routing (DV, LS, protocols RIP, OSPF, BGP), transport protocols (TCP), congestion avoidance (window based AIMD), and application design models (clientserver, P2P, functioning of HTTP, SMTP, IMAP). Programming assignments will be designed to test network application design concepts, protocol design towards developing error detection and correction methods, efficient network utilization, and familiarization with basic tools such as ping, traceroute, wireshark.

COP701 Software Systems Laboratory

3 Credits (0-0-6)

The contents may differ each year depending on the instructor. The course should involve 2-3 large programming projects done in groups of 2-4. A set of three project oriented assignments which will be announced at the start of each semester with definite submission deadlines. The set of assignments will be designed to develop skills and familiarity with a majority of the following: make, configuration management tools, installation of software, archiving and creation of libraries, version control systems, documentation and literate programming systems, GUI creation, distributed state maintenance over a network, programming in different environments like desktop and handhelds, program parsing and compilation including usage of standard libraries like pthreads, numerical packages, XML and semi-structured data, simulation environments, testing and validation tools.

COL702 Advanced Data Structures and Algorithms

4 Credits (3-0-2)

Pre-requisite(s): COL106 OR Equivalent

Overlaps with: COL351

Review of basic data structures and their realization in object oriented Environments. Dynamic Data structures: 2-3 trees, Redblack trees, binary heaps, binomial and Fibonacci heaps, Skip lists, Universal Hashing. Data structures for maintaining ranges, intervals and disjoint sets with applications. B-trees. Tries and suffix trees. Priority queues and binary heaps. Sorting: merge, quick, radix, selection and heap sort, Graphs: Breadth first search and connected components. Depth first search in directed and undirected graphs. Disjkra's algorithm, Directed acyclic graphs and topological sort. Some geometric data-structures. Basic algorithmic techniques like dynamic programming and divide-and-conquer. Sorting algorithms with analysis, integer sorting. Graph algorithms like DFS with applications, MSTs and shortest paths.

COL703 Logic for Computer Science

4 Credits (3-0-2)

Pre-requisite(s): COL106 OR Equivalent

Overlaps with: MTL747, COL765 & COL226

Review of the principle of mathematical induction; the principle of structural induction; review of Boolean algebras; Syntax of propositional formulas; Truth and the semantics of propositional logic; Notions of satisfiability, validity, inconsistency; Deduction systems for propositional logic; Completeness of deduction systems; First order logic (FOL); Proof theory for FOL; introduction to model theory; completeness and compactness theorems; First order theories. Programming exercises will include representation and evaluation; conversion to normal-forms; tautology checking; proof normalization; resolution; unification; Skolemization, conversion to Horn-clauses; binary-decision diagrams. Decidability, undecidability and complexity results. Introduction to formal methods, temporal/modal logics.

COL718 Architecture of High Performance Computers

4 Credits (3-0-2)

Pre-requisite(s): COL216 OR Equivalent

Classification of parallel computing structures; Instruction level parallelism - static and dynamic pipelining, improving branch performance, superscalar and VLIW processors; High performance memory system; Shared memory multiprocessors and cache coherence; Multiprocessor interconnection networks; Performance modelling; Issues in programming multiprocessors; Data parallel architectures.

COL719 Synthesis of Digital Systems

4 Credits (3-0-2)

Pre-requisite(s): COL215 OR Equivalent

After a basic overview of the VLSI design flow, hardware modelling principles and hardware description using the VHDL language are covered. This is followed by a study of the major steps involved in behavioural synthesis: scheduling, allocation, and binding. This is followed by register-transfer level synthesis, which includes retiming and Finite State Machine encoding. Logic synthesis, consisting of combinational logic optimisation and technology mapping, is covered next. Popular chip architectures - standard cells and FPGA are introduced. The course concludes with a brief overview of layout synthesis topics: placement and routing.

COL720 Real Time Systems

4 Credits (3-0-2)

Pre-requisite(s): COL331, COL216

Types of real time systems; hard and soft real time systems; reference models; priority driven approaches for real time scheduling; clock based scheduling, schedulability tests; scheduling aperiodic and sporadic jobs; slack stealing; resource access control mechanics; priority ceiling protocols; multiprocessor scheduling; scheduling flexible computations; real time communication; real time operating systems; real time embedded systems.

COL722 Introduction to Compressed Sensing

3 Credits (3-0-0)

Pre-requisite(s): COL106 OR Equivalent

Sparsity, L1 minimization, Sparse regression, deterministic and probabilistic approaches to compressed sensing, restricted isometry property and its application in sparse recovery, robustness in the presence of noise, algorithms for compressed sensing. Applications in magnetic resonance imaging (MRI), applications in analog-to-digital conversion, low-rank matrix recovery, applications in image reconstruction.

COL724 Advanced Computer Networks

4 Credits (3-0-2)

Pre-requisite(s): COL334 OR Equivalent

Review of the Internet architecture, layering; wired and wireless MAC; intra- and inter-domain Internet routing, BGP, MPLS, MANETs; error control and reliable delivery, ARQ, FEC, TCP; congestion and flow control; QoS, scheduling; mobility, mobile IP, TCP and MAC interactions, session persistence; multicast; Internet topology, economic models of ISPs/CDNs/content providers; future directions.

COL726 Numerical Algorithms

4 Credits (3-0-2)

*Pre-requisite(s): COL106 OR Equivalent**Overlaps with: MTL704*

Number representation, fundamentals of error analysis, conditioning, stability, polynomials and root finding, interpolation, singular value decomposition and its applications, QR factorization, condition number, least squares and regression, Gaussian elimination, eigenvalue computations and applications, iterative methods, linear programming, elements of convex optimization including steepest descent, conjugate gradient, Newton's method.

COL728 Compiler Design

4.5 Credits (3-0-3)

Pre-requisite(s): COL 216, COL 226 OR Equivalent

Compilers and translators; lexical and syntactic analysis, top-down and bottom up parsing techniques; internal form of source programs; semantic analysis, symbol tables, error detection and recovery, code generation and optimization. Type checking and static analysis. Static analysis formulated as fixpoint of simultaneous semantic equations. Data flow. Abstract interpretation. Correctness issues in code optimizations. Algorithms and implementation techniques for type-checking, code generation and optimization. Students will design and implement translators, static analysis, type-checking and optimization. This is a praxis-based course. Students will use a variety of software tools and techniques in implementing a complete compiler.

COL729 Compiler Optimization

4.5 Credits (3-0-3)

*Pre-requisite(s): COL 216, COL 226 OR Equivalent**Overlaps with: COL728*

Program representation – symbol table, abstract syntax tree; Control flow analysis; Data flow analysis; Static single assignment; Def-use and Use-def chains; Early optimizations – constant folding, algebraic simplifications, value numbering, copy propagation, constant propagation; Redundancy Elimination – dead code elimination, loop invariant code motion, common sub-expression elimination; Register Allocation; Scheduling – branch delay slot scheduling, list scheduling, trace scheduling, software pipelining; Optimizing for memory hierarchy – code placement, scalar replacement of arrays, register pipelining; Loop transformations – loop fission, loop fusion, loop permutation, loop unrolling, loop tiling; Function inlining and tail recursion; Dependence analysis; Just-in-time compilation; Garbage collection. Laboratory component would involve getting familiar with internal representations of compilers; profiling and performance evaluation; and the design and implementation of novel compiler optimizations.

COL730 Parallel Programming

4 Credits (3-0-2)

Pre-requisite(s): COL106, COL331

Parallel computer organization, Parallel performance analysis, Scalability, High level Parallel programming models and framework, Load distribution and scheduling, Throughput, Latency, Memory and Data Organizations, Inter-process communication and synchronization, Shared memory architecture, Memory consistency, Interconnection network and routing, Distributed memory architecture, Distributed shared memory, Parallel IO, Parallel graph algorithms, Parallel Algorithm techniques: Searching, Sorting, Prefix operations, Pointer Jumping, Divide-and-Conquer, Partitioning, Pipelining, Accelerated Cascading, Symmetry Breaking, Synchronization (Locked/Lock-free).

COL732 Virtualization and Cloud Computing

4 Credits (3-0-2)

Pre-requisite(s): COL331

Introduction to Virtualization and Cloud Computing; Binary Translation; Hardware Virtualization; Memory Resource Management in Virtual Machine Monitor; Application of Virtualization; Cloud-scale Data Management and Processing; I/O Virtualization.

COL733 Cloud Computing Technology Fundamentals

4 Credits (3-0-2)

Pre-requisite(s): COL331

Overview of Cloud Computing, Virtualisation of CPU, Memory and I/O Devices; Storage Virtualisation and Software Defined Storage (SDS), Software Defined Networks (SDN) and Network Virtualisation, Data Centre Design and interconnection Networks, Cloud Architectures, Public Cloud Platforms (Google App Engine, AWS, Azure), Cloud Security and Trust Management, Open Source Clouds (Baadal, Open Stack, Cloud Stack), Cloud Programming and Software Environments (Hadoop, GFS, Map Reduce, NoSQL systems, Big Table, HBase, Libvirt, OpenVswitch), Amazon (IaaS), Azure(PaaS), GAE (PaaS)

COL740 Software Engineering

4 Credits (3-0-2)

Pre-requisite(s): COL106, COL226

Introduction to Software Engineering, Software Life Cycle models and Processes, Requirement Engineering, System Models, Architectural Design, Abstraction & Modularity, Structured Programming, Object-oriented techniques, Design Patterns, Service Oriented Architecture, User Interface Design, Verification and Validation, Reliability, Software Evolution, Project Management & Risk Analysis, Software Quality Management, Configuration Management, Software Metrics, Cost Analysis and Estimation, Manpower Management, Organization and Management of large Software Projects.

COD745 Minor Project

3 Credits (0-0-6)

Pre-requisite(s): EC 75

Research and development projects based on problems of practical and theoretical interest. Evaluation will be based on periodic presentations, student seminars, written reports, and evaluation of the developed system (if applicable).

COP745 Digital System Design Laboratory

3 Credits (0-0-6)

Pre-requisite(s): COL215 OR Equivalent

Being primarily a laboratory course, it would consist of a series of assignments that would increase in complexity in terms of designs to be carried out. Each assignment would involve learning to translate starting from natural language specifications to HDL design representation. The students would use modern synthesis techniques to realize these designs on FPGA boards before testing them for functionality as well as performance. Students would also be required to specify and implement a project (small system design) as part of the course.

COL750 Foundations of Automatic Verification

4 Credits (3-0-2)

Pre-requisite(s): COL226, COL352 OR Equivalent

A selection from the following topics, and experiments with the mentioned tools: Review of first-order logic, syntax and semantics. Resolution theorem proving. Binary Decision Diagrams (BDDs) and their use in representing systems. (Programming exercises coding and using logic programming frameworks). Transition systems, automata and transducers. Buchi and other automata on infinite words; Linear Time Temporal Logic (LTL), and specifying properties of systems in LTL; the relationship between temporal logic and automata on infinite words, LTL Model checking (exercises using Spin or similar tools); Computational Tree Logic (CTL and CTL*); CTL model checking (exercises); Process calculi such as CSP and CCS. Notions of program equivalence -- traces, bisimulation and other notions. Hennessy-Milner Logic (HML) and Mu calculus (exercises using tools such as CWB -- Concurrency Work Bench). Symbolic model checking, exercises using tools such as SMV. Sat-based model checking and Davis-Putnam procedure; (exercises using tools such as nuSMV). Possible additional topics include: equational logic frameworks, real-time frameworks, reactive frameworks, pi-calculus (exercises using tools such as the Mobility Workbench), Tree automata and Weak Second-order Logic with k successors (WSkS), (exercises using Mona or similar tools).

COL751 Algorithmic Graph Theory

3 Credits (3-0-0)

Pre-requisite(s): COL351 OR Equivalent

Algorithms for computing maximum s-t flows in graphs: augmenting path, blocking flow, push-relabel, capacity scaling etc. Max-flow min-cut theorem and its applications. Algorithms for computing min-cuts in graphs, structure of min-cuts. Min-cost flows and applications: cycle cancelling algorithms, successive shortest paths, strongly polynomial algorithms. Maximum matching in bipartite and general graphs: Hall's theorem, Tutte's theorem, Gallai-Edmonds decomposition. Weighted bipartite matching, Edmonds Algorithm for Weighted Non-Bipartite Matching, T-joins and applications. Factor-Critical Graphs, Ear Decompositions, Graph orientations, Splitting Off, k-Connectivity Orientations and Augmentations, Arborescences and Branchings, Edmonds theorem for disjoint arborescences. Planar graphs, algorithms for checking planarity, planar-separator theorem and its applications. Intersection graphs, perfect graphs: polyhedral characterization, the strong perfect graph theorem, kinds of perfect graphs and algorithms on them. Treewidth, algorithm for computing tree width, algorithms on graphs with bounded tree width.

COL752 Geometric Algorithms

4 Credits (3-0-2)

Pre-requisite(s): COL351 OR Equivalent

Geometric Fundamentals: Models of computation, lower bound techniques, geometric primitives, geometric transforms Convex hulls: Planar convex hulls, higher dimensional convex hulls, randomized, output-sensitive, and dynamic algorithms, applications of convex hull, Intersection detection: segment intersection, line sweep, map overlay, halfspace intersection, polyhedra intersection, Geometric searching: segment, interval, and priority-search trees, point location, persistent data structure, fractional cascading, range searching, nearest-neighbor searching Proximity problems: closest pair, Voronoi diagram, Delaunay triangulation and their subgraphs, spanners, well separated pair decomposition Arrangements: Arrangements of lines and hyperplanes, sweep-line and incremental algorithms, lower envelopes, levels, and zones, applications of arrangements Triangulations: monotone and simple polygon triangulations, point-set triangulations, optimization criteria, Steiner triangulation, Delaunay refinement Geometric sampling: random sampling and ϵ -nets, ϵ -approximation and discrepancy, cuttings, coresets Geometric optimization: linear programming, LP-type problems, parametric searching, approximation techniques. Implementation Issues: robust computing, perturbation techniques, floating-point filters, rounding techniques.

COL753 Complexity Theory

3 Credits (3-0-0)

Pre-requisite(s): COL352 OR Equivalent

Modeling computation (Finite state machines, Non-determinism, Turing machines, class P etc.), NP and NP-completeness, Diagonalization (Time hierarchy and Ladner's theorem), Space complexity (PSPACE, NL, Savitch's theorem, Immerman-Szelepcsényi theorem etc.), Polynomial hierarchy, Boolean circuits (P/poly), Randomized classes (RP, BPP, ZPP, Adleman's Theorem, Gács-Sipser-Lautemann Theorem), Interactive proofs (Arthur-Merlin, IP=PSPACE), Cryptography (one-way functions, pseudorandom generators, zero knowledge), PCP theorem and hardness of approximation, Circuit lower bounds (Hastad's switching lemma), Other topics (#P, Toda's theorem, Average-case complexity, derandomization, pseudorandom construction).

COL754 Approximation Algorithms

3 Credits (3-0-0)

Pre-requisite(s): COL351 OR Equivalent

NP-hardness and approximation algorithms. Different kinds of approximability. Greedy algorithm and local search with applications in facility location, TSP and scheduling. Dynamic programming with applications in knapsack, Euclidean TSP, bin packing. Linear programming, duality and rounding. Applications in facility location, Steiner tree and bin packing. Randomized rounding with applications. Primal-dual algorithms and applications in facility location and network design. Cuts and metrics with applications to multi-commodity flow. Semi-definite programming and applications: max-cut, graph coloring. Hardness of approximation.

COL756 Mathematical Programming

3 Credits (3-0-0)

*Pre-requisite(s): COL351 OR Equivalent**Overlaps with: MTL103, MTL704*

Linear programming: introduction, geometry, duality, sensitivity analysis. Simplex method, Large scale optimization, network simplex. Ellipsoid method, problems with exponentially many constraints, equivalence of optimization and separation. Convex sets and functions – cones, hyperplanes, norm balls, generalized inequalities and convexity, perspective and conjugate functions. Convex optimization problems – quasi-convex, linear, quadratic, geometric, vector, semi-definite. Duality – Lagrange, geometric interpretation, optimality conditions, sensitivity analysis. Applications to approximation, fitting, statistical estimation, classification. Unconstrained minimization, equality constrained minimization and interior point methods. Integer Programming: formulations, complexity, duality. Lattices, geometry, cutting plane and branch and bound methods. Mixed integer optimization.

COL757 Model Centric Algorithm Design

4 Credits (3-0-2)

Pre-requisite(s): COL351 OR Equivalent

The RAM model and its limitations, Introduction to alternate algorithmic models Parallel models like PRAM and Interconnection networks; Basic problems like Sorting, Merging, Routing, Parallel Prefix and applications, graph algorithms like BFS, Matching Memory hierarchy models; Caching, Sorting, Merging, FFT, Permutation, Lower bounds Data Structures - searching, Priority queues Streaming Data models: Distinct items, frequent items, frequency moments, estimating norms, clustering On line algorithms: competitive ratio, list accessing, paging, k-server, load-balancing, lower-bounds.

COL758 Advanced Algorithms

4 Credits (3-0-2)

Pre-requisite(s): COL351 OR Equivalent

Advanced data structures: self-adjustment, persistence and multidimensional trees. Randomized algorithms: Use of probabilistic inequalities in analysis, Geometric algorithms: Point location, Convex hulls and Voronoi diagrams, Arrangements applications using examples. Graph algorithms: Matching and Flows. Approximation

algorithms: Use of Linear programming and primal dual, Local search heuristics. Parallel algorithms: Basic techniques for sorting, searching, merging, list ranking in PRAMs and Interconnection networks.

COL759 Cryptography & Computer Security

3 Credits (3-0-0)

Pre-requisite(s): COL351, MTL106 OR Equivalent

Overlaps with: MTL730

Part 1: Foundations: Perfect secrecy and its limitations, computational security, pseudorandom generators and one time encryption, pseudorandom functions, one way permutations, message authentication and cryptographic hash functions.

Part 2: Basic Constructions and proofs: Some number theory, symmetric key encryption, public key encryption, CPA and CCA security, digital signatures, oblivious transfer, secure multiparty computation.

Part 3: Advanced Topics: Zero knowledge proofs, identity based encryption, broadcast encryption, homomorphic encryption, lattice based cryptography.

COL760 Advanced Data Management

4 Credits (3-0-2)

Pre-requisite(s): COL362 OR Equivalent

Storage and file structures, advanced query processing and optimization for single server databases, distributed data management (including distributed data storage, query processing and transaction management), web-data management (including managing the web-graph and implementation of web-search), big data systems.

COL761 Data Mining

4 Credits (3-0-2)

Pre-requisite(s): COL106 OR Equivalent

Association rule-mining, FP-tree, Prefix-span, Multi-support rule mining, Frequent subgraph mining (gSpan and FSG), Clustering (Agglomerative clustering, k-means, k-medoid, DBSCAN, OPTICS, CURE, BFR, MCL). Data streams (FM sketch, Reservoir sampling, top k-counting), Anomaly detection (Density based techniques, chi-square tests, p-values), Influence maximization in social networks, SimRank, random walk with restarts, PageRank, HITS.

COL762 Database Implementation

4 Credits (3-0-2)

Pre-requisite(s): COL362 OR Equivalent

Review of Relational Model, Algebra and SQL, File structures, Constraints and Triggers, System Aspects of SQL, Data Storage, Representing Data Elements, Index, Multi dimensional and Bit-map Indexes, Hashing, Query Execution, Query Compiler.

COL764 Information Retrieval and Web Search

4 Credits (3-0-2)

Retrieval models (Boolean, vector-space, probabilistic, language-model, Markov random fields, diversity-aware); Design of test collections (TREC, crowd-sourcing) and retrieval effectiveness measures (micro-/macro-F measure, nDCG, BPref); Collection models (multinomial repr.; topic mixtures) and topic modeling (LSA/LSI, LDA); Search engine architecture (crawling, indexing, and web-page ranking); Learning to rank; Knowledge graphs; Responsible IR (e.g., handling bias and fake-news, privacy, etc.).

COL765 Intro. To Logic and Functional Programming

4 Credits (3-0-2)

Pre-requisite(s): COL106 OR Equivalent

Overlaps with: COL226 & COL703

Introduction to declarative programming paradigms. The functional style of programming, paradigms of developments of functional programs, use of higher order functionals and pattern-matching. Introduction to lambda calculus. Interpreters for functional languages and abstract machines for lazy and eager lambda calculi, Types,

type-checking and their relationship to logic. Logic as a system for declarative programming. The use of pattern-matching and programming of higher order functions within a logic programming framework. Introduction to symbolic processing. The use of resolution and theorem-proving techniques in logic programming. The relationship between logic programming and functional programming.

COL768 Wireless Networks

4 Credits (3-0-2)

Pre-requisite(s): COL334 OR Equivalent

Radio signal propagation, advanced modulation and coding, medium access techniques, self-configurable networks, mesh networks, cognitive radio and dynamic spectrum access networks, TCP over wireless, wireless security, emerging applications.

COL770 Advanced Artificial Intelligence

4 Credits (3-0-2)

Pre-requisite(s): COL106 OR Equivalent

Overlap with: COL333, ELL789

Philosophy of artificial intelligence, fundamental and advanced search techniques (A*, local search, suboptimal heuristic search, search in AND/OR graphs), constraint optimization, temporal reasoning, knowledge representation and reasoning through propositional and first order logic, modern game playing (UCT), planning under uncertainty (Topological value iteration, LAO*, LRTDP), reinforcement learning, introduction to robotics, introduction to probabilistic graphical models (Bayesian networks, Hidden Markov models, Conditional random fields), machine learning, introduction to information systems (information retrieval, information extraction).

COL772 Natural Language Processing

4 Credits (3-0-2)

Pre-requisite(s): COL106 OR Equivalent

Overlaps with: MTL785

NLP concepts: Tokenization, lemmatization, part of speech tagging, noun phrase chunking, named entity recognition, co-reference resolution, parsing, information extraction, sentiment analysis, question answering, text classification, document clustering, document summarization, discourse, machine translation.

Machine learning concepts: Naive Bayes, Hidden Markov Models, EM, Conditional Random Fields, MaxEnt Classifiers, Probabilistic Context Free Grammars.

COL774 Machine Learning

4 Credits (3-0-2)

Pre-requisite(s): MTL106 OR Equivalent

Overlaps with: COL341 ELL784, ELL888

Supervised learning algorithms: Linear and Logistic Regression, Gradient Descent, Support Vector Machines, Kernels, Artificial Neural Networks, Decision Trees, ML and MAP Estimates, K-Nearest Neighbor, Naive Bayes, Introduction to Bayesian Networks. Unsupervised learning algorithms: K-Means clustering, Gaussian Mixture Models, Learning with Partially Observable Data (EM). Dimensionality Reduction and Principal Component Analysis. Bias Variance Trade-off. Model Selection and Feature Selection. Regularization. Learning Theory. Introduction to Markov Decision Processes. Application to Information Retrieval, NLP, Biology and Computer Vision. Advanced Topics.

COL776 Learning Probabilistic Graphical Models

4 Credits (3-0-2)

Pre-requisite(s): MTL106 OR Equivalent

Basics: Introduction. Undirected and Directed Graphical Models. Bayesian Networks. Markov Networks. Exponential Family Models. Factor Graph Representation. Hidden Markov Models. Conditional Random Fields. Triangulation and Chordal Graphs. Other Special Cases: Chains, Trees. Inference: Variable Elimination (Sum Product and Max-Product). Junction Tree Algorithm. Forward Backward

Algorithm (for HMMs). Loopy Belief Propagation. Markov Chain Monte Carlo. Metropolis Hastings. Importance Sampling. Gibbs Sampling. Variational Inference. Learning: Discriminative Vs. Generative Learning. Parameter Estimation in Bayesian and Markov Networks. Structure Learning. EM: Handling Missing Data. Applications in Vision, Web/IR, NLP and Biology. Advanced Topics: Statistical Relational Learning, Markov Logic Networks.

COL780 Computer Vision

4 Credits (3-0-2)

Pre-requisite(s): EC 80

Overlaps with: ELL793

Camera models. Calibration, multi-views projective geometry and invariants. Feature detection, correspondence and tracking. 3D structure/motion estimation. Application of machine learning in object detection and recognition, category discovery, scene and activity interpretation.

COL781 Computer Graphics

4.5 Credits (3-0-3)

Pre-requisite(s): COL106 OR Equivalent

Overlaps with: ELL792

Graphics pipeline; Graphics hardware: Display devices, Input devices; Raster Graphics: line and circle drawing algorithms; Windowing and 2D/3D clipping: Cohen and Sutherland line clipping, Cyrus Beck clipping method; 2D and 3D Geometrical Transformations: scaling, translation, rotation, reflection; Viewing Transformations: parallel and perspective projection; Curves and Surfaces: cubic splines, Bezier curves, B-splines, Parametric surfaces, Surface of revolution, Sweep surfaces, Fractal curves and surfaces; Hidden line/surface removal methods; illuminations model; shading: Gouraud, Phong; Introduction to Ray-tracing; Animation; Programming practices with standard graphics libraries like OpenGL.

COL783 Digital Image Analysis

4.5 Credits (3-0-3)

Pre-requisite(s): COL106, ELL205 OR Equivalent

Overlap with: ELL715

Digital Image Fundamentals; Image Enhancement in Spatial Domain: Gray Level Transformation, Histogram Processing, Spatial Filters; Image Transforms: Fourier Transform and their properties, Fast Fourier Transform, Other Transforms; Image Enhancement in Frequency Domain; Color Image Processing; Image Warping and Restoration; Image Compression; Image Segmentation: edge detection, Hough transform, region based segmentation; Morphological operators; Representation and Description; Features based matching and Bayes classification; Introduction to some computer vision techniques: Imaging geometry, shape from shading, optical flow; Laboratory exercises will emphasize development and evaluation of image processing methods.

COL786 Advanced Functional Brain Imaging

4 Credits (3-0-2)

Introduction to human Neuro-anatomy, Hodgkin Huxley model, overview of brain imaging methods, introduction to magnetic resonance imaging, detailed fMRI, fMRI data analysis methods, general linear model, network analysis, machine learning based methods of analysis.

COL788 Advanced Topics in Embedded Computing

3 Credits (3-0-0)

Pre-requisite(s): COL216, COL331 OR Equivalent

Overlaps with: ELL782

Embedded Platforms, Embedded processor architectures, System initialization, Embedded operating systems (linux), DSP and graphics acceleration, Interfaces, Device Drivers, Network, Security, Debug support, Performance tuning. The course would involve substantial programming assignments on embedded platforms.

COS799 Independent Study

3 Credits (0-3-0)

The student will be tasked with certain reading assignments and related problem solving in a appropriate area of research in Computer Science under the overall guidance of a CSE Faculty member. The work will be evaluated through term paper.

COL812 System Level Design and Modelling

3 Credits (3-0-0)

Pre-requisite(s): COL719

Embedded systems and system-level design, models of computation, specification languages, hardware/software co-design, system partitioning, application specific processors and memory, low power design.

COL818 Principles of Multiprocessor Systems

4 Credits (3-0-2)

Pre-requisite(s): COL216, COL351, COL331 OR Equivalent

Mutual Exclusion, Coherence and Consistency, Register Constructions, Power of Synchronization Operations, Locks and Monitors, Concurrent queues, Futures and Work-Stealing, Barriers, Basics of Transactional Memory (TM), Regular Hardware TMs, Unbounded Hardware TMs, Software TMs.

COL819 Advanced Distributed Systems

4 Credits (3-0-2)

Pre-requisite(s): COL331, COL334, COL380 OR Equivalent

Epidemic/Gossip based algorithms, Peer to peer networks, Distributed hash tables, Synchronization, Mutual exclusion, Leader election, Distributed fault tolerance, Large scale storage systems, Distributed file systems, Design of social networking systems.

COP820 Processor Design Laboratory

4 Credits (0-0-8)

Pre-requisite(s): COL718

This is a pure laboratory course that involves the following activities. Design of branch predictors, instruction fetch logic, Decode and rename logic, Instruction window and scheduler, Select logic, Load-square queue, ALUs and by-pass paths, Instruction commit logic, Misprediction and recovery techniques, Selective replay techniques.

COL821 Reconfigurable Computing

3 Credits (3-0-0)

Pre-requisite(s): COL719

FPGA architectures, CAD for FPGAs: overview, LUT mapping, timing analysis, placement and routing, Reconfigurable devices - from fine-grained to coarse-grained devices, Reconfiguration modes and multi-context devices, Dynamic reconfiguration, Compilation from high level languages, System level design for reconfigurable systems: heuristic temporal partitioning and ILP-based temporal partitioning, Behavioral synthesis, Reconfigurable example systems' tool chains.

COL829 Advanced Computer Graphics

4 Credits (3-0-2)

Pre-requisite(s): COL781

Rendering: Ray tracing, Radiosity methods, Global illumination models, Shadow generation, Mapping, Anti-aliasing, Volume rendering, Geometrical Modeling: Parametric surfaces, Implicit surfaces, Meshes, Animation: spline driven, quaternions, articulated structures (forward and inverse kinematics), deformation- purely geometric, physically-based, Other advanced topics selected from research papers.

COL830 Distributed Computing

3 Credits (3-0-0)

Pre-requisite(s): COL226 OR Equivalent

Models of Distributed Computing; Basic Issues: Causality, Exclusion,

Fairness, Independence, Consistency; Specification of Distributed Systems: Transition systems, petri nets, process algebra properties: Safety, Liveness, stability.

COL831 Semantics of Programming Languages

3 Credits (3-0-0)

Pre-requisite(s): COL226, COL352

Study of operational, axiomatic and denotational semantics of procedural languages; semantics issues in the design of functional and logic programming languages, study of abstract data types.

COL832 Proofs and Types

3 Credits (3-0-0)

Pre-requisite(s): COL226, COL352

Syntax and semantic foundations: Ranked algebras, homomorphisms, initial algebras, congruences. First-order logic review: Soundness, completeness, compactness. Herbrand models and Herbrand's theorem, Horn-clauses and resolution. Natural deduction and the Sequent calculus. Normalization and cut elimination. Lambda-calculus and Combinatory Logic: syntax and operational semantics (beta-eta equivalence), confluence and Church-Rosser property. Introduction to Type theory: The simply-typed lambda-calculus, Intuitionistic type theory. Curry-Howard correspondence. Polymorphism, algorithms for polymorphic type inference, Girard and Reynolds' System F. Applications: type-systems for programming languages; modules and functors; theorem proving, executable specifications.

COL851 Special Topics in Operating Systems

3 Credits (3-0-0)

Pre-requisite(s): COL331 Or Equivalent

To provide insight into current research problems in the area of operating systems. Topics may include, but are not limited to, OS design, web servers, Networking stack, Virtualization, Cloud Computing, Distributed Computing, Parallel Computing, Heterogeneous Computing, etc.

COL852 Special Topics in COMPILER DESIGN

3 Credits (3-0-0)

Pre-requisite(s): COL728/COL729

Special topic that focuses on state of the art and research problems of importance in this area.

COL860 Special Topics in Parallel Computation

3 Credits (3-0-0)

The course will focus on research issues in areas like parallel computation models, parallel algorithms, Parallel Computer architectures and interconnection networks, Shared memory parallel architectures and programming with OpenMP and Pthreads, Distributed memory message-passing parallel architectures and programming, portable parallel message-passing programming using MPI. This will also include design and implementation of parallel numerical and non-numerical algorithms for scientific and engineering, and commercial applications. Performance evaluation and benchmarking high-performance computers.

COL861 Special Topics in Hardware Systems

3 Credits (3-0-0)

Under this topic one of the following areas will be covered: Fault Detection and Diagnosability. Special Architectures. Design Automation Issues. Computer Arithmetic, VLSI.

COL862 Special Topics in Software Systems

3 Credits (3-0-0)

Special topic that focuses on state of the art and research problems of importance in this area.

COL863 Special Topics in Theoretical Computer Science

3 Credits (3-0-0)

Pre-requisite(s): COL351

Under this topic one of the following areas will be covered: Design and Analysis of Sequential and Parallel Algorithms. Complexity issues, Trends in Computer Science Logic, Quantum Computing and Bioinformatics, Theory of computability. Formal Languages. Semantics and Verification issues.

COL864 Special Topics in Artificial Intelligence

3 Credits (3-0-0)

Pre-requisite(s): COL333/COL671/Equivalent

Potential topics or themes which may be covered (one topic per offering) include: information extraction, industrial applications of AI, advanced logic-based AI, Markov Decision Processes, statistical relational learning, etc.

COL865 Special Topics in Computer Applications

3 Credits (3-0-0)

Pre-requisite(s): Permission of the Instructor

Special topic that focuses on special topics and research problems of importance in this area.

COL866 Special Topics in Algorithms

3 Credits (3-0-0)

Pre-requisite(s): COL 351 OR Equivalent

The course will focus on specialized topics in areas like Computational Topology, Manufacturing processes, Quantum Computing, Computational Biology, Randomized algorithms and other research intensive topics.

COL867 Special Topics in High Speed Networks

3 Credits (3-0-0)

Pre-requisite(s): COL334 OR COL672

The course will be delivered through a mix of lectures and paper reading seminars on advanced topics in Computer Networks. Hands-on projects will be conceptualized to challenge students to take up current research problems in areas such as software defined networking, content distribution, advanced TCP methodologies, delay tolerant networking, data center networking, home networking, green networking, clean state architecture for the Internet, Internet of things, etc.

COL868 Special topics in Database Systems

3 Credits (3-0-0)

Pre-requisite(s): COL334/COL672/Equivalent

The contents would include specific advanced topics in Database Management Systems in which research is currently going on in the department. These would be announced every time the course is offered.

COL869 Special topics in Concurrency

3 Credits (3-0-0)

The course will focus on research issues in concurrent, distributed and mobile computations. Models of Concurrent, Distributed and Mobile computation. Process calculi, Event Structures, Petri Nets an labeled transition systems. Implementations of concurrent and mobile, distributed programming languages. Logics and specification models for concurrent and mobile systems. Verification techniques and algorithms for model checking. Type systems for concurrent/mobile programming languages. Applications of the above models and techniques.

COL870 Special Topics in Machine Learning

3 Credits (3-0-0)

Pre-requisite(s): COL341 OR Equivalent

Contents may vary based on the instructor's expertise and interests within the broader area of Machine Learning. Example topics include (but not limiting to) Statistical Relational Learning, Markov Logic, Multiple Kernel Learning, Multi-agent Systems, Multi-Class

Multi-label Learning, Deep Learning, Sum-Product Networks, Active and Semi-supervised Learning, Reinforcement Learning, Dealing with Very High-Dimensional Data, Learning with Streaming Data, Learning under Distributed Architecture.

COL871 Special Topics in Programming Languages

3 Credits (3-0-0)

Pre-requisite(s): COL765 or (COL226+COL202)

The course will focus on one or more specialised research topics such as Operational and Denotational Semantics, Domain Specific Languages, Types Systems, Flow Analysis, Abstract Interpretation, Static Analysis, Program Synthesis, etc.

COL872 Special Topics in Cryptography

3 Credits (3-0-0)

Pre-requisite(s): COL759 OR Equivalent

Contents may vary based on the instructor's interests within the broader area of Cryptography. Examples include CCA secure encryption, multiparty computation, leakage resilient cryptography, broadcast encryption, fully homomorphic encryption, obfuscation, functional encryption, zero knowledge, private information retrieval, byzantine agreement, cryptography against extreme attacks etc.

COL873 Special Topics in Natural Language Processing

3 Credits (3-0-0)

Pre-requisite(s): COL772

The course will focus on one or two specialised research topics such as conversational systems, question answering, semantic parsing, representation learning, linguistics in machine learning, automated summarisation systems, etc.

COL874 Special Topics in Compilers and Language Implementation

3 Credits (3-0-0)

Pre-requisite(s): COL765 or (COL226+COL202)

The course will focus on one or more specialised research topics such as Runtime Environments, Dynamic Analysis, Runtime Monitoring and Verification, Code Optimisation, Code Generation, Machine Program Synthesis, etc.

COL876 Special Topics in Formal Methods

3 Credits (3-0-0)

Pre-requisite(s): COL765 or (COL703+COL226)

The course will focus on one or more specialised research topics in: Model-checking; theorem-proving; rewriting; abstractions and abstraction refinement; formal frameworks for specification and modelling; game-theoretic techniques; verification of probabilistic systems; Markov decision processes; symbolic-, abstraction- and automata-based methods and algorithms for the verification of hardware, software, hybrid, real-time, concurrent and distributed systems.

COL886 Special Topics in Operating Systems

3 Credits (3-0-0)

Special topic that focuses on the state of the art and research problems of importance in this area.

COV876 Special Module on Automated Reasoning Methods for Program Analysis

Course Categories: DE for CSI. PE for CS5. PE(SS) for MCS.

1 Credit (1-0-0)

Pre-requisite(s): EC100 for UG

Through the course students will (1) get exposure to fundamental concepts in building automated reasoning tools to support deployment of formal methods for software and cyber physical systems, (2) get an overview of the advanced state of the art approaches towards

building automated reasoning tools, (3) learn about foundational aspects so as to prepare them to pursue these topics and related literature independently for research and use in system design and other applications and (4) become aware of exciting new directions in research on software and system analysis, particularly techniques for automatically generating invariant properties.

COV877 Special Module on Visual Computing

1 Credit (1-0-0)

The course will be a seminar-based course where the instructor would present topics in a selected theme in the area of visual computing through research papers. Students will also be expected to participate in the seminar.

COV878 Special Module in Machine Learning

1 Credit (1-0-0)

Contents may vary based on the instructor's expertise and interests within the broader area of Machine Learning. Example topics include (but not limiting to) Statistical Relational Learning, Markov Logic, Multiple Kernel Learning, Multi-agent Systems, Multi-Class Multi-label Learning, Deep Learning, Sum-Product Networks, Active and Semi-supervised Learning, Reinforcement Learning, Dealing with Very High-Dimensional Data, Learning with Streaming Data, Learning under Distributed Architecture.

COV879 Special Module in Financial Algorithms

1 Credit (1-0-0)

Pre-requisite(s): MTL106 OR Equivalent

Overlap with: MTL 732 & MTL 733

Special module that focuses on special topics and research problems of importance in this area.

COV880 Special Module in Parallel Computation

1 Credits (1-0-0)

Pre-requisite(s): Permission of Instructor

Special module that focuses on special topics and research problems of importance in this area.

COV881 Special Module in Hardware Systems

1 Credits (1-0-0)

Pre-requisite(s): Permission of Instructor

Special module that focuses on special topics and research problems of importance in this area.

COV882 Special Module in Software Systems

1 Credits (1-0-0)

Special module that focuses on special topics and research problems of importance in this area.

COV883 Special Module in Theoretical Computer Science

1 Credits (1-0-0)

Pre-requisite(s): COL 351 OR equivalent

Special module that focuses on special topics and research problems of importance in this area.

COV884 Special Module in Artificial Intelligence

1 Credits (1-0-0)

Pre-requisite(s): COL333/COL671/Equivalent

Special module that focuses on special topics and research problems of importance in this area.

COV885 Special Module in Computer Applications

1 Credits (1-0-0)

Special module that focuses on special topics and research problems of importance in this area.

COV886 Special Module in Algorithms

1 Credits (1-0-0)

Pre-requisite(s): COL351 OR Equivalent

Special module that focuses on special topics and research problems of importance in this area.

COV887 Special Module in High Speed Networks

1 Credits (1-0-0)

Pre-requisite(s): COL 334 OR COI 672

The course will be delivered through a mix of lectures and paper reading seminars on advanced topics in Computer Networks. Students will be introduced to topics such as software defined networking, content distribution, advanced TCP methodologies, delay tolerant networking, data center networking, home networking, green networking, clean state architecture for the Internet, Internet of things, etc.

COV888 Special Module in Database Systems

1 Credits (1-0-0)

Pre-requisite(s): COL362 OR COL632 OR Equivalent

Potential topics or themes which may be covered (one topic per offering) include: data mining, big data management, information retrieval and database systems, semantic web data management, etc.

COV889 Special Module in Concurrency

1 Credits (1-0-0)

Special module that focuses on special topics and research problems of importance in this area.

COD891 M.Tech. Minor Project

3 Credits (0-0-6)

Research and development oriented projects based on problems of practical and theoretical interest. Evaluation done based on periodic presentations, student seminars, written reports, and evaluation of the developed system (if applicable). Students are generally expected to work towards the goals and mile stones set for Minor Project COP 891.

COD892 M.Tech. Project Part-I

7 Credits (0-0-14)

It is expected that the problem specification and milestones to be achieved in solving the problem are clearly specified. Survey of the related area should be completed. This project spans also the course COP892. Hence it is expected that the problem specification and the milestones to be achieved in solving the problem are clearly specified.

COD893 M.Tech. Project Part-II

14 Credits (0-0-28)

Pre-requisite(s): COD 892

The student(s) who work on a project are expected to work towards the goals and milestones set in COP893. At the end there would be a demonstration of the solution and possible future work on the same problem. A dissertation outlining the entire problem, including a survey of literature and the various results obtained along with their solutions is expected to be produced by each student.

COD895 MS Research Project

36 Credits (0-0-72)

Department of Design

DSL710 Framework of Design

2 Credits (2-0-0)

Definition of design as an industrial and social activity. Understanding of 'design' as a noun and as a verb. Design as a case of ill structured, ill defined, ill constrained problem solving. Comparative study of production processes in art, engineering and design. Design as cycle of analysis, synthesis, and validation of ideas. Design as the meeting point of the user needs, technology affordance and business goals. History of art and design. Influence of society and culture on design. Study of successful and failed products. Study of evolution of designed products. Consideration of advertising, marketing, consumer satisfaction, prevalent expertise, economic viability, production ecosystem, future prediction, legal and statutory concerns, IPR issues in design success.

DSP711 Computer Aided Product Detailing

3 Credits (1-0-4)

Introduction to computer aided industrial design. The technique of concurrent engineering. Using databases for material selection, Structure of CAD programs and hardware. Introduction to surface modelling. Detailed study of surface modelling software. Studio Exercises in Surface modelling applications. Drawing. Surfacing. Modelling. Editing & Advanced Editing. Shading. Lighting. Texturing. Backgrounds. Environments. Animation techniques and product Animation.

DSP712 Exhibitions and Environmental Design

3 Credits (2-0-2)

History of exhibition design. Human movements and exhibition plans. Concept of physical and psychological space. Design of physical environment for human comfort and function. Study of fixtures and fittings. Design and use of modular and fixed elements in display design. Lights and illumination systems. Types of lights. Study of indoor and outdoor lighting requirements. Innovative materials and processes in exhibitions. Outdoor and indoor land-scaping. Types of pavilions. Space requirement calculation in design. Design of murals, artifacts, exhibits and models. Use of background, negative space, foreground, proportion and scale in exhibition composition. Exercises and projects.

DSP721 Design and Innovation Methods

3 Credits (1-0-4)

1. Understanding of factors that directly or indirectly influence the product definition and its context. Assessing relevance of available products in the futuristic context. 2. Research planning strategies, finding real challenges, Methods of Exploring design situations, developing questionnaires for interviewing users. 3. Searching for visual inconsistencies, 4. Creativity methods, Brainstorming, Syntectics, 5. Issue Tree, Mind Mapping, 6. Story Boarding, Image boarding 7. Six-Thinking Hats, Harvey Cards, Lotus Blossom, COCD, 8. Lateral Thinking, Wishful Thinking. 9. Specification writing, 10. Methods of exploring problem structure, Product-environment and Product-component interaction, 11. Alexanders method of determining components, 12. Interaction Matrix and net, 13. Analysis of interconnected decision areas, System innovation, 14. Functional Innovation by boundary shifting, through boundary searching and experimentation.

DSP722 Applied Ergonomics

2 Credits (1-0-2)

Definition, origin, scope and goals of ergonomics as a field of study. Examples of applications of ergonomics in design. Types of data from human at physical, physiological, cognitive and affective levels. Data gathering and analysis techniques. Use of descriptive and inferential statistics in ergonomic data. Applications of mean, median, mode and percentile in anthropometry. Use of anthropometry in workstation design. Human physiological potentials and limitations in terms of load carrying capacity. Concept of comfort, fatigue and stress. Design for the cognitive user. Concept of mental workload. Cognitive perspective in control panel design and graphical user interface design.

DSP731 Communication and Presentation Skills

3 Credits (1-0-4)

Concept of sketching for designers, sketching through geometrical shapes, Sketching in isometric grids, sculpting conceptual objects while sketching through cuboids. The use of shade and shadows, Rendering, physical product modeling through frugal materials and by the use of MDF, HIPS, Vacuum forming, modeling in FRP, product photography, video recording for presentations.

DSL732 Adv. Mat. Processes & Die Design

3 Credits (2-0-2)

Understanding properties and selection of natural and manmade materials including metals, plastics, ceramics, composites and natural materials.

Understanding various manufacturing and prototyping methods including digital manufacturing/ prototyping.

Hands on product realization exercises involving selection of materials and manufacturing processes.

Die and mould manufacturing methods including surface treatment and finishing processes.

Prototyping projects involving CNC, 3-D Printing, Vacuum forming, etc.

DSP741 Product Interface & Design

2 Credits (1-0-2)

A product as a living organism, its interface externally with the environment and internally with its components. 2. Interface for modulating user involvement. 3. Product Semantics, communication of feelings, 4. Communication of structure and purpose. 5. Communication through form, color, graphics and text. 6. Typography choice and readability, Printing and Transfer Techniques. 7. Product graphics. 8. Functioning of controls and display elements, knobs, push buttons, handles and electronic displays. 9. Investigation and study of visual, functional and ergonomic requirements of controls and displays, legibility of display elements. 10. Study of different textures, patterns and materials. 11. Area, volume and Proportion. 12. Order and system. 13. Human factors and safety in interface design. 14. Individually planned design projects involving research analysis and design of product interface.

DSL751 Form and Aesthetics

3 Credits (2-0-2)

Elements of design, Nature inspired design, Gestalt, Product semantics, Color theory and color trends, Varied approaches for form, Product styling, case studies and design discourse on form, exercises on from development of a product (existing or conceptual).

DSR761 Social Immersion

0 Credit (0-0-2)

Documentation of societal issues through photography, recordings, sketches. Identification of locale of working, Identification of a potential societal issue. Presenting the societal issues as a report/presentation/video.

DSR762 Vehicle Design

3 Credits (2-0-2)

History of transportation, technology trends in transportation and futuristic predictions. Types of personal vehicles, mass transportation vehicles, their benefits and challenges in design. Trends and styling of two wheelers and four wheelers. Material and finish considerations in styling. Use of mood boards and cultural trends in transportation design. Vehicle design for rural India. Design projects and exercises.

DSR772 Transportation Design

3 Credits (2-0-2)

Understanding different segments of design practice in transportation. Different role of designers in Automobile Industry. Design of human powered vehicles, Two wheelers design, Design of four wheelers, future of transportation, Styling, Professional practice: CAS and Clay.

DSL782 Design for Usability*3 Credits (2-0-2)*

History of increase in complexity and usability since WW-2. Story of transition in human society from Man-Machine Interaction to Human-Computer Interaction. Relationship between product complexity and mental workload. Subjective and objective measurements of product complexity and mental workload. User centered design process for usable product design. Introduction to concept of 'mental models' and exercises in understanding users' mental models. Creation of Personas and scenarios. Conduct of task analysis. Operational definitions of usability. Measurement of ease of use, efficiency and effectiveness of digital products. Design of interactive products from usability perspective. Development of user screeners, testing protocols and conduct of usability tests. Creation of paper prototypes, wireframes, information architecture. Conduct of low fidelity tests, card sorting, reverse card sorting, affordance tests, high fidelity testing and brand testing.

DSD792 Design Project-I*3 Credits (0-0-6)*

Aim of the project to help the student independently solve a design problem against an pre-identified design brief.

DSD 799 Design Project*4 Credits (1-0-6)*

Need Identification, Need Validation, Solution Identification, Design/ Solution Validation, Design Presentation.

DSR801 Summer Internship*0 Credits (0-0-4)*

Identifying of the project area, setting the objectives, milieu and deliverables of the Internship, report writing/Presentation.

DSL810 Special Topics in Design-I*3 Credits (3-0-0)*

Special topics in design.

DSR812 Media Studies*3 Credits (2-0-2)*

To enable designers to use different media optimally. Principles and processes of photography, videography, print and animation. Study of design constraints and affordances in differ media. Exercises in photography, videography, print, animation Cinematography etc. Design of corporate identity programs.

DSL820 Special Topics in Design-II*3 Credits (3-0-0)*

Special topics in design.

DSV820 Special Modules in Design*1 Credit (1-0-0)***DSR822 Design for Sustainability***3 Credits (2-0-2)*

Concept of sustainability, Tipple bottom line, world vision for sustainability, Emerging trends in the area of sustainability, Metrics for measurement of sustainability, Product lifecycle management and sustainability, Ecodesign.

DSR832 Design for User Experience*3 Credits (3-0-0)*

Importance of user experience approach in design. Methods to understand users' experiences. Modeling of user behaviors. Cognitive, affective and cultural perspectives in experiences. Consideration for human experiences in interaction design. Methods of direct, indirect, subjective and objective measurements of human experiences. Issues of reliability and validity in experience measurement. Qualitative interview techniques for gathering user motivations and emotions. Analysis of qualitative experiential data from users. Gender and cultural biases in experience measurements. Management of psychological space in user experience testing setups. Development of user experience strategy, creation of user interfaces and testing of digital products from experiential perspective.

DSL841 Design Management and Professional Practice*3 Credits (3-0-0)*

Considerations in professional design startups including setting up a design office, getting finances, finding clients, running the office, business correspondence, brief and briefing, feasibility reports, letters of contract. Estimates of design fee as lump sum, hourly basis, consulting, commissioning and royalties. Study of govt. regulations, consumer protection acts, ISI standards, design registrations, patents and copyrights. Professional ethics in design practice. Creativity theory. Integrated product development. Assessing risks and opportunities. Cost cutting in design.

DSR852 Strategic Design Management*3 Credits (2-0-2)*

Branding and brand development, Repositioning in market, disruptive innovation for market capitalization, Retail design, design of services, designing for new businesses.

DSR862 Design in Indian Context*3 Credits (3-0-0)*

Introduction to culture from product design perspective. Models and definitions of culture. Product design culture of India. Culture as an aid in consumer product choice. Cross cultural biases in product decisions. Cross cultural design teams. Considerations in designing for a user from another culture. Exercises in product as a cultural thought. Culture in evolutionary perspective and design of new material cultures through products and lifestyles design.

DSD891 Design Project-II*6 Credits (0-0-12)*

The student will be able to practice the design process to solve a professionally challenging design problem. The student should exhibit the sensitivity to the multidimensionality of the problems in the design domain. They should be able to prove their design outcome as viable and practice solution for the given problem. The students are expected to exhibit their work to the professional community.

DSD892 Industry/ Research Design Project*9 Credits (0-0-18)*

To develop the ability to look at design problems from a research perspective. The student is expected to contribute to the professional design field thorough new design knowledge generation. The project is aimed to polish the designer's research skills. The designer is expected to deliver cutting edge research and be able to articulate it professionally.

Department of Electrical Engineering

ELL101 Introduction to Electrical Engineering

4 Credits (3-1-0)

Elements in an Electrical circuit: R, L, C, Diode, Voltage and current sources (independent and dependent/controlled sources). DC circuits, KCL, KVL, Network theorems, Mesh and nodal analysis. Step response in RL, RC, RLC circuits. Phasor analysis of AC circuits. Single phase and 3-phase circuits. Two port network, BJT: CE and small signal model, Operational amplifiers: Model and applications, Introduction to Digital circuits. Magnetic circuits, Transformers: Modeling and analysis, parameter determination. Energy in magnetic field. Electromechanical energy conversion principles with examples. Principles of measurement of voltage, current and power.

ELP101 Introduction to Electrical Engineering (Laboratory)

1 Credits (0-0-2)

CRO (mechanism and usage). KCL, KVL, Network theorem verification. Step/ transient response of RL, RC, RLC, circuits. Steady state response of Circuits of sinusoidal excitation. Diode experiment (clipping, clamping and rectification). Basic circuits using opamp. Transformers OC and SC tests. BH loop in an iron core, DC and AC motor – for observation only. A small mini-project.

ELL201 Digital Electronics

4.5 Credits (3-0-3)

Pre-requisite(s): ELL101

Gates, binary number systems, arithmetic operations. Minimization using K-maps, reduced K-maps, tabular methods; design using multiplexers, decoders, and ROMs. Latches, flip-flops, registers and counters. Asynchronous, synchronous counters. Finite state machines, implementations thereof. Mealy, Moore machines. Clock period computation. Memories. Partitioning and pipelining. VHDL/Verilog, the register-transfer-level description style. Switch level introduction to logic families, CMOS logic, static, pre-charge and clocked logic. Asynchronous circuits and design styles.

ELL202 Circuit Theory

4 Credits (3-1-0)

Pre-requisite(s): ELL101

Overview of network analysis techniques, network theorems, transient and steady-state sinusoidal response. Network graphs and their applications in network analysis. Tellegen's theorem, two-port networks, Z, Y, h, g, and transmission matrices. Combining two ports in various configurations. Analysis of transmission lines to motivate the scattering matrix. Scattering matrix and its applications in network analysis. Network functions, positive real functions, and network synthesis. Butterworth and Chebyshev approximations. Synthesis of lossless two-port networks. Synthesis of lattice all-pass filters.

ELL203 Electromechanics

4 Credits (3-1-0)

Pre-requisite(s): ELL101

Review: AC Circuits, Complex representation and Power Measurement. Magnetic Circuits: Simple magnetic circuit, analogy between magnetic circuits and electrical circuits, linear and nonlinear magnetic circuits, hysteresis and eddy current losses, permanent magnet materials. Transformers: Single-phase and three-phase, analysis, equivalent circuit, Tests on transformers, phasor diagram regulation and efficiency, auto-transformer and instrument transformers (PT/CT). Electro-mechanical energy conversion principles: Force and EMF production in a rotating machine.

DC machines: Types, construction, working principle, characteristics and applications.

3-phase induction machines: Types, construction, Introduction to windings and winding factor, production of revolving magnetic field, working principle on 3-phase induction machine, equivalent circuit, characteristics, phasor diagram and applications.

3-phase synchronous machines: Types, construction, working

principle, equivalent circuit, characteristics, phasor diagram and applications.

Fractional-HP and Special Machines.

ELP203 Electromechanics Laboratory

1.5 Credits (0-0-3)

Pre-requisite(s): ELL101

ELL205 Signals and Systems

4 Credits (3-1-0)

Motivation & orientation, Classifications of signals & systems, Dynamic representation of LTI systems (discrete & continuous-time systems), Fourier analysis of continuous-time signals & systems, Fourier analysis of discrete-time signals & systems, Nyquist sampling theorem, Laplace transform, The z-transform, Introduction to probability, random variables and stochastic processes.

ELL211 Physical Electronics

3 Credits (3-0-0)

Pre-requisite(s): ELL101 and PVL101

Overlaps with: ELL732, ELL231, EPL336, EPL439, PHL653, PHL704, PHL705, PHL727, PHL793

Semiconductor materials, crystal structure, carriers in semiconductors, band structure, density of states, excitons, doping and carrier statistics, carrier transport, recombination and generation, p-n junction physics: built-in potential, forward and reverse bias, capacitance, diode currents, breakdown, tunnel effects; metal-semiconductor junctions; BJTs: current gain/Gummel plots, transistor models, breakdown; MOSFET physics: MOS capacitors, inversion, depletion, accumulation, flatband, threshold voltage, long-channel model, saturation, short-channel models, sub-threshold conduction, SPICE models for MOSFETs; optoelectronic device physics, LEDs/OLEDs, lasers, photodetectors, solar cells.

ELL212 Electromagnetics

4 Credits (3-1-0)

Pre-requisite(s): PVL101

Review of Maxwell's equations, wave propagations in unbounded medium. Boundary conditions, reflection and refraction of plane waves. Evanescent waves and surface plasmons. Waveguides: parallel-plane guide, TE, TM and TEM waves, rectangular and cylindrical waveguides, resonators. Dielectric guides and optical fibres. Transmission Lines: distributed parameter circuits, traveling and standing waves, impedance matching, Smith chart, analogy with plane waves. Planar transmission lines: stripline, micro stripline. Radiation: retarded potentials, Hertzian dipole, short loop, antenna parameters. Numerical techniques in electromagnetics.

ELP212 Electromagnetics Laboratory

1.5 Credits (0-0-3)

Pre-requisite(s): ELL212

ELL225 Control Engineering

4 Credits (3-1-0)

Pre-requisite(s): ELL205

Overlaps with: MCL212, CLL261

Introduction to the control problem, Control System Components: Sensors, Actuators, Computational blocks. Mathematical representation of systems, state variable model, linearization, transfer function model. Transfer function and state variable models of suitable mechanical, electrical, thermal and pneumatic systems. Closed loop systems, Block diagram and signal flow analysis, Basic Characteristics of feedback control systems: stability, steady-state accuracy, transient accuracy, disturbance rejection, sensitivity analysis and robustness. Basic modes of feedback control: Proportional, Integral, Derivative. Concept of stability, Stability criteria: Routh stability criterion, Mikhailov's criterion, Kharitonov theorem. Time response of 2nd order system, steady state error analysis. Performance specifications in the

time domain. Root locus method of design. Nyquist stability criterion. Frequency response analysis: Nyquist plots, Bode plots, Nichols Charts, Performance specifications in frequency domain, Frequency domain methods of design. Lead lag compensation.

ELP225 Control Engineering Laboratory

1.5 Credits (0-0-3)

Pre-requisite(s): ELL225

Basics of Sensors and Actuators, Study of AC and DC Motors, Linear Systems, Analog and Digital Motors, Synchros, Temperature Control.

ELL231 Power Electronics and Energy Devices

3 Credits (3-0-0)

Pre-requisite(s): ELL101

Introduction to semiconductor basics and PN Junctions. Short introduction to power device technology, PIN diodes, Schottky diodes, Power BJTs, Power MOSFETs, IGBTs, Thyristors, Wide bandgap power semiconductor devices, Packaging and Reliability of Power devices, Destructive mechanisms in power devices, Power device induced oscillations and Electromagnetic disturbances, Selection of power devices in power electronic systems, Smart power integrated circuits.

ELL301 Electrical and Electronics Instrumentation

3 Credits (3-0-0)

Pre-requisite(s): ELL101

Basics of Measurement and Instrumentation, Instrument Examples: Galvanometer, Accelerometer etc; calibration methods, Voltage and Current Measurements; Theory, calibration, application, Errors and compensation. Power and Energy Measurement and its errors, Methods of correction, LPF wattmeter, Phantom loading, Induction type KWH meter; Calibration of wattmeter, energy meter. Potentiometer and Instrument Transformer :DC and AC potentiometer, C.T. and V.T. construction, theory, operation, characteristics. Digital Instrumentation.

ELL302 Power Electronics

3 Credits (3-0-0)

Pre-requisite(s): ELL231 (EE3)/ELL211 (EE1)

Introduction to Power Electronics devices and protection: Thyristor family devices, principle of operation, IGBT operation, principles and ratings. Snubber designs, selection and protection, Firing circuits.

AC-DC converters: uncontrolled, semi-controlled, fully controlled and dual converters in single-phase and three-phase configurations, design, phase control, harmonic analysis, firing circuits and their designs. Improved power quality AC-DC converters.

Choppers: Introduction to dc-dc conversion, various topologies, buck, boost, buck-boost converters, High frequency isolated dc-dc converters: design problems, PWM control and operation.

Inverters: Basics of dc to ac conversion, inverter circuit configurations and principle of operation, VSI and CSI, single and three-phase configurations, Square wave and sinusoidal PWM control methods and harmonic control. Design problems.

AC voltage controllers: Introduction to ac to ac conversion, single-phase and three-phase ac voltage controller circuit configurations, applications, advantages, harmonic analysis, control, design problems.

Cyclo-converters: single-phase to single-phase, three-phase to single-phase, three-phase to three-phase and single-phase to three-phase circuit configurations thyristors and triacs.

ELP302 Power Electronics Laboratory

1.5 Credits (0-0-3)

Pre-requisite(s): ELL302

ELL303 Power Engineering-I

4 Credits (3-1-0)

Pre-requisite(s): ELL101, ELL203

Introduction to the basic structure of power system along with various

power generation technologies. Modeling of generators, transformers and transmission line for power system analysis. per unit system. Power flow analysis. Fault analysis in power systems. Power system stability studies. Transients in power system and travelling waves. Introduction to power system relaying and brief idea of over current, differential and impedance based protection. Basic concepts of Power system operation and control. Introduction to HVDC and FACTS.

ELP303 Power Engineering Laboratory

1.5 Credits (0-0-3)

Pre-requisite(s): ELP303

Experiments will be conducted on 3-phase alternators and transformers for measuring their sequence impedance. Directional, overcurrent and differential protection relays will be studied. Computer simulation for power flow, short circuit and stability studies of interconnected power systems. Numerical relays and synchrophasors will be introduced. FACTS devices will be experimented.

ELL304 Analog Electronics

5.5 Credits (3-1-3)

Pre-requisite(s): ELL101, ELL202, ELL211, ELL231

Review of working of BJT and MOSFET, large signal and small signal models, biasing schemes, analysis and design of various single stage amplifier configuration, low and high frequency analysis of single stage amplifiers, frequency compensation, current mirrors, multistage amplifiers; differential and operational amplifiers, negative and positive feedback, oscillators and power amplifiers.

ELL305 Computer Architecture

3 Credits (3-0-0)

Pre-requisite(s): ELL201

Overlaps with: CSL211

Introduction: Performance measurement, Instruction Set Architecture, Computer Arithmetic, Processor: ALU design, Control design, Pipelining, Memory Hierarchy, I/O management, Multicores, Multiprocessors, Clusters, GPU.

ELP305 Design and System Laboratory

1.5 Credits (0-0-3)

ELS310 Independent Study (EE1)

3 Credits (0-3-0)

ELL311 Communication Engineering

4 Credits (3-1-0)

Pre-requisite(s): ELL205

Review of Fourier Series and Transforms. Hilbert Transforms, BandpassSignal and System Representation. Random Processes, Stationarity, Power Spectral Density, Gaussian Process, Noise. Amplitude Modulation, DSBSC, SSB, VSB: Signal Representation, Generation and Demodulation. Frequency Modulation: Signal Representation, Generation and Demodulation. Mixing, Superheterodyne Receiver, Phase Recovery with PLLs. Noise: in AM Receivers using Coherent Detection, in AM Receivers using Envelope Detection, in FM Receivers. Sampling, Pulse-Amplitude Modulation. Quantization, Pulse-Code Modulation. Noise considerations in PCM, Time Division Multiplexing, Delta Modulation. Intersymbol Interference, Introduction to Information Theory: concepts of Entropy and Source-Coding

ELP311 Communication Engineering Laboratory

1 Credit (0-0-2)

Pre-requisite(s): ELL311

Laboratory experiments on analog, pulse, and basic digital modulation and demodulation techniques.

ELL312 Semiconductor Process Technology

3 Credits (3-0-0)

Pre-requisite(s): ELL211

Semiconductor materials (inorganic and organic), history of semiconductor IC devices, crystal structure, defects, vacancies and interstitials, semiconductor crystal growth, bulk doping methods, purification methods, wafer manufacture, diffusion, surface doping, oxidation, dopant redistribution, ion implantation and annealing, rapid thermal processes, photolithography, masks, photoresists, exposure, e-beam lithography, vacuum systems, gas flow, plasma processes, pumping theory, leaks, vacuum gauges, wet etching, plasma etching, process gas chemistry and polymerization, ion milling, reactive ion etching, lift-off, vapor pressure of materials, evaporation, sputtering, deposition rate and step coverage, codepositions, film growth mechanisms and stress, chemical vapor deposition, metal-organic chemical vapor deposition, atomic layer deposition, molecular beam epitaxy, planarization processes, interconnects, yield and device integration.

ELL313 Antennas and Propagation

3 Credits (3-0-0)

Prerequisite(s): ELL212

Starting from the principle of radiation different types of antenna; wire, slot, planar and their arrays with feeds. Antenna synthesis and design and measurements. Characteristics of propagation of radio waves in different atmospheric layers and study of the losses, fading and scattering of microwave and millimeter waves in the atmosphere.

ELL315 Introduction to Analog Integrated Circuits

3 Credits (3-0-0)

Pre-requisite(s): ELL204, ELL202

Review of basic amplifiers. Current Mirrors, Reference Current and Voltage Sources. CMOS Operational Amplifier: Structure, Analysis and Design, Frequency Response and Compensation Techniques. Switched Capacitor Circuits: Principles of operation, Filter and non filter applications. Sample and Hold Circuits, Comparators. ADC: Characterization, Types of ADC and their relative merits and demerits, Design issues. DAC: Characterization, Types of DAC and their relative merits and demerits, Design issues.

ELL316 Introduction to VLSI Design

3 Credits (3-0-0)

Pre-requisite(s): ELL211

Basic MOS characteristics; Deep sub-micron; velocity saturation; Dynamic MOS characteristics; parasitics; leakage; sizing; propagation delay; Logical effort, path delay, optimization; Ratio-ed logic, Pass transistor logic and parasitics; Dynamic logic, pulsed sequential logic; Logical synthesis, physical design, layout; Introduction to design of VLSI memories.

ELL318 Digital Hardware Design

3 Credits (3-0-0)

Pre-requisite(s): ELL305

Overlaps with: CSL316

Technology basics and digital logic families such as static CMOS, pass transistor, transmission gate, dynamic and domino logic. Advanced sequential logic elements with latch-based design and timing and clocking concepts. Design flows and paradigms. Data path, control and advanced pipeline implementations. Advanced digital arithmetic. Performance evaluation.

ELL319 Digital Signal Processing

4 Credits (3-0-2)

Pre-requisite(s): ELL205

Overlaps with: ELL720

Review of Signals and Systems, Sampling and data reconstruction processes. Z transforms. Discrete linear systems. Frequency domain design of digital filters. Quantization effects in digital filters. Discrete Fourier transform and FFT algorithms. High speed convolution and its application to digital filtering.

ELS330 Independent Study (EE3)

3 Credits (0-3-0)

ELL332 Electric Drives

3 Credits (3-0-0)

Pre-requisite(s): ELL203

Basic Concepts: Characteristics and operating modes of drive motors. Starting, braking and speed control of motors. 4 quadrant drives. Types of loads. Torque and associated controls used in process industries.

DC Motor Drives: Characteristics, Starting Methods, Braking Methods, Speed Control Using Converters and Choppers.

Three phase Induction Motor Drives: Characteristics and Equivalent Circuits, Starting Methods, Braking Methods, Speed Control of Cage Rotor Induction Machines using as AC voltage controllers, Voltage-Source and Current-Source Inverters. V-by-F Control and other Control Techniques. Speed Control of Wound-Rotor Induction Machines using Rotor Resistance Variation; Slip-Power Recovery Scheme.

Three phase Synchronous Motor Drives: Characteristics and Equivalent Circuits, Starting Methods, Braking Methods, Speed Control in True Synchronous and Self Control Modes.

Special Machines: Permanent Magnet Brush-Less Motor Drives, Permanent Magnet Synchronous Motor Drives, Stepper and Reluctance Motor Drives.

ELP332 Electric Drives Laboratory

1.5 Credits (0-0-3)

Pre-requisite(s): ELL332

ELL333 Multivariable Control

3 Credits (3-0-0)

Pre-requisite(s): ELL225

Overlaps with: ELL721

Review of control system fundamentals and basic linear algebra. Introduction to linear dynamical systems and properties. State-space representation and canonical realizations. Relation between state-space and transfer function representations. Similarity transformation. Diagonalization. Jordan canonical form. Matrix exponential and its properties. Solution of state equations. Cayley-Hamilton Theorem, Stability: BIBO and internal. Linearization of nonlinear systems. Controllability and Observability. Minimal realization. State feedback and observer design. Linear Quadratic Regulator.

ELL334 DSP based Control of Drives

4 Credits (3-0-2)

Pre-requisite(s): ELL203, ELL332

Introduction and Application of DSP in the power electronic converter controlled drives, Types of processors used for power control and their comparison, computational advantages, Limitations. Introduction to peripherals ADC, DAC, PWM, Encoders and their interface. Interfacing issues, Sampling process, Harmonic analysis in real-time using a DSP, Assembly language programming of a DSP, Motor control applications. Pulse-Width Modulation and Pulse-Frequency Modulation schemes, lookup tables and real-time computation. Interfacing and signal conditioning circuits for DSP based schemes. Realization of computationally intensive algorithms like variable structure, adaptive and neural network schemes for Drives systems.

ELL335 CAD of Electric Machines

4 Credits (3-0-2)

Pre-requisite(s): ELL103

1. Basic Considerations, 2. Design of Main Dimensions, 3. Transformer Design, 4. Design of rotating machines, 5. Computer Aided Design of Transformers, 6. Computer Aided Design of DC machines, 7. Computer Aided Design of Synchronous Machines, 8. Computer Aided Design of Induction Machines, 9. Computer Aided Design of Special Machines.

ELL363 Power Engineering-II

3 Credits (3-0-0)

Pre-requisite(s): ELL303

Advanced concepts in power flow analysis, security analysis and state estimation. Economic load dispatch and unit commitment problem. Voltage and frequency control in power systems. Advanced concepts in multi-machine dynamics and stability. Electrical transients in power systems. Wind and solar generation technologies and their integration into the grid. Issues in restructured power systems. Modern numerical protection.

ELL365 Embedded Systems

3 Credits (3-0-0)

Overview of Embedded Systems; Embedded System Architecture: processor example ARM, PIC, etc.; features of digital signal processor; SOC, memory subsystem, bus structure (PCI, I2C, SPI etc.), interfacing protocols (USB, IrDA etc), testing and debugging, power management; Embedded System Software: Program Optimization, Concurrent Programming, Realtime Scheduling and I/O management; Networked Embedded Systems: special networking protocols (CAN, Bluetooth); Applications.

ELL400 Power Systems Protection

3 Credits (3-0-0)

Pre-requisite(s): ELL303

Fundamentals of Power system protection, philosophy of protective relays, Different types of relays, Introduction to protection elements like CT, PT, CB, Isolator etc, (includes CT and PT class, CB transients, CB rating and testing, Arc extinction in CB), Over current relays: Principle, operation and setting, Directional relays : needs and operating principle, Power system components protected using over current relays, Differential relays: Principle, operation and setting, Protection of three phase transformer, bus bar and generator using differential relays, Distance relays : Principle, operation and setting, Simple impedance relay, reactance relay, Mho relay and angle impedance relays, Quadrilateral relays, Transmission line protection using distance relays, Static relays: principle, amplitude comparator and phase comparator, Phase comparator realization using positive coincidence period, Distance relay realization using comparators, Generator protection, Overview of Numerical relaying and few algorithms, Phasor extraction, Introduction to PMU and its use, Fault location.

ELL401 Advanced Electromechanics

3 Credits (3-0-0)

Pre-requisite(s): ELL203

Introduction to Advancement in Electromechanics, Permanent Magnet Brushless DC Machines, Permanent Magnet Synchronous Motors, Switched Reluctance Motors, Single-Phase Machines, Axial Field Machines and other Advanced Electrical Machines, Introduction to Control of Advanced Electrical Machines, Applications in Industry, Domestic Appliances, Electric Mobility, etc., Computer Aided Simulation and Design of Advanced Electrical Machines, Case Studies.

ELL402 Computer Communication

3 Credits (3-0-0)

*Pre-requisite(s): MEL250**Overlaps with: ELL785, COL334*

(i) Introduction, network structure: Basic networking concepts, Motivations for layered network concepts, Network examples; (ii) OSI reference model: Layering concepts, Overview of different layer functionalities; (iii) TCP/IP: Layering concepts, Layered functionalities, packet formats, fragmentation, Different layer protocols and examples: ARP, ICMP, etc., Congestion and error control; (iv) Network examples and functionalities: Ethernet, hub, bridge, switch, WANs, MANs, LANs, PANs, BANs; (v) Basic network protocol analysis:

Performance metrics, Queueing models; (vi) Multiaccess protocols: Need for multiaccess protocols, Contention-free access schemes, Contention-based protocols: ALOHA, CSMA; (vii) Routing in data networks: Basic graph theoretic concepts, spanning tree, Shortest path routing, distance vector routing, link state routing, RIP, OSPF; (viii) Cross-layer protocol optimization concepts: Distributed control, cost and energy efficiencies.

ELL405 Operating Systems

3 Credits (3-0-0)

*Pre-requisite(s): ELL305**Overlaps with: COL331, MTL458, ELL783*

Introduction to OS; Process and Thread management; Scheduling; Concurrent threads and processes: mutual exclusion, synchronization, inter-process communication; Memory management: Cache and Virtual Memory management; Resource management: deadlock and its prevention; File management; I/O management; Introduction to real time systems; Elements distributed operating systems.

ELL406 Robotics and Automation

3 Credits (3-0-0)

Pre-requisite(s): ELL225

Introduction to robotics. Basic components of robotic systems. Coordinate Transformation, D-H parameters. Forward and inverse kinematics. Velocity kinematics and Jacobian, Singularity analysis, Robot Dynamics : Holonomic and Non-Holonomic Systems. Trajectory planning. Robot control: linear and nonlinear. Actuators and Sensors. Vision based Robotic Control. Mobile Robots : Modeling and Control.

ELL408 Low power circuit design

3 Credits (3-0-0)

Pre-requisite(s): ELL211

MOS Transistors, MOS Inverters, Static CMOS Circuits, MOS Dynamic Circuits, Pass Transistor Logic Circuits, MOS Memories, Finite State Machines, Switching Power Dissipation, Dynamic Power Dissipation, Leakage Power Dissipation, Supply Voltage Scaling, Minimizing Switched Capacitance Minimizing Leakage Power, Variation Tolerant Design, Battery-Driven System Design.

ELL409 Machine Intelligence and Learning

4 Credits (3-0-2)

*Pre-requisite(s): MTL106, COL106**Overlaps with: ELL784, ELL789, COL341/COL774*

Introduction to machine intelligence and intelligent agents; problem solving; knowledge representation and reasoning (logical and probabilistic); need for learning; basics of machine learning; Decision Trees; Rule-based models; linear learning models; Support Vector Machines; Artificial Neural Networks; Deep Learning; Probabilistic Modelling; Naive Bayes; Reinforcement Learning; Clustering; Feature Selection; Principal Component Analysis; Combining models; Philosophical issues in intelligence and learning. Substantive implementation assignments or a term project involving design of an intelligent learning-based system.

ELL410 Multicore Systems

3 Credits (3-0-0)

Motivation for multicores; Multithreading; Flynn's taxonomy; Stream processing (vector, GPU). Message passing; Shared memory; Cache coherence in multiprocessor Synchronisation; Interconnection networks; Benchmarks and advanced topics; Project.

ELD411 B.Tech. Project-I

3 Credits (0-0-6)

ELL411 Digital Communications

4 Credits (3-0-2)

Pre-requisite(s): ELL311

Overlaps with: ELL712

Matched Filter, Error Rate due to Noise. Intersymbol Interference, Nyquist's Criterion, Duobinary Signaling. Optimum Linear Receiver, Geometric Representation of Signals. Coherent Detection of Signals in Noise, Probability of Error. Coherent Digital Modulation Schemes: MPSK, MFSK, MQAM; Error Analysis. Noncoherent FSK, Differential PSK. Comparison of Digital Modulation Schemes, Bandwidth Efficiency. Pseudo-Noise Sequences and Spread Spectrum, Trellis coded modulation, Digital signaling over fading multipath channels, OFDM communications systems.

ELP411 Digital Communications Laboratory

1 Credit (0-0-2)

Pre-requisite(s): ELP311

ELL417 Renewable Energy Systems

3 Credits (3-0-0)

Pre-requisite(s): ELL203

Modeling of wind resource, aerodynamic characteristics, wind energy generators – steady-state and dynamic modeling, electrical and pitch controller design, effect of induction generators on grid operation, solar Photovoltaic systems – steady state and dynamic modeling, MPPT operation, power electronic systems for solar PV, fuel cells.

ELD431 B.Tech. Project-I

3 Credits (0-0-6)

ELL431 Power System Optimization

3 Credits (3-0-0)

Pre-requisite(s): ELL303

Characteristic of Generation units, Economic dispatch of thermal plants, Unit commitment, Hydrothermal coordination, Maintenance scheduling, Emission minimization, Optimal Power flow, Security constrained optimization, Optimization of distribution networks, Optimization in Power Markets.

ELL433 CAD of Power Electronics Systems

4 Credits (3-0-2)

Pre-requisite(s): ELP302

Introduction to Power Electronic systems, Mathematical modeling of power electronic systems, State-space modeling, Average model, Circuit averaging model, Canonical circuit model, small-signal models and circuit transfer functions. Introduction to power electronics simulators, system oriented simulators, circuit simulators, merits and limitations. Introduction to magnetic design, high frequency inductor and transformer design. Hands-on exercise problems on power electronic circuits simulation using PSPICE/ SIMULINK/ PSIM simulators.

ELL436 Digital control

3 Credits (3-0-0)

Pre-requisite(s): ELL225

ELL437 Switched Mode Power Conversion

3 Credits (3-0-0)

Pre-requisite(s): ELL231

To give an introduction about the power switching devices such as thyristors, GTO, MOSFETS, BJT, IGBT and MCTS. Basic concept of gate drivers (Trigger techniques, optical isolators, protection circuits, and isolation transformers), snubber design and protection schemes of power devices are to be discussed. Basic circuit configurations, design and analysis of choppers (step-up, step-down, step-up/down and multi-phase choppers), DC-DC converters (non-isolated and

isolated), inverters (voltage and current source configurations) are discussed. This is followed by improved power quality converters (non-isolated and isolated) for reduction of harmonics at AC mains.

ELL440 Power Systems Protection

Fundamentals of Power system protection, philosophy of protective relays, Different types of relays, Introduction to protection elements like CT, PT, CB, Isolator etc, (includes CT and PT class, CB transients, CB rating and testing, Arc extinction in CB). Over current relays: Principle, operation and setting, Directional relays: needs and operating principle, Power system components protected using over current relays. Differential relays: Principle, operation and setting, Protection of three phase transformer, bus bar and generator using differential relays. Distance relays: Principle, operation and setting, Simple impedance relay, reactance relay, Mho relay and angle impedance relays, Quadrilateral relays, Transmission line protection using distance relays. Static relays: principle, amplitude comparator and phase comparator, Phase comparator realization using positive coincidence period, Distance relay realization using comparators.

Generator protection. Overview of Numerical relaying and few algorithms, Phasor extraction, Introduction to PMU and its use, Fault location.

ELD450 BTP Part-II

8 Credits (0-0-16)

ELL450 Selected Topics in AE-I

3 Credits (3-0-0)

ELD451 BTP Part-II

8 Credits (0-0-16)

ELV451 Special Modules in SG&RE-I

1 Credit (1-0-0)

Pre-requisite(s): to be decided by the instructor

ELD452 BTP Part-II

8 Credits (0-0-16)

ELL452 Special Topics in EET-I

3 Credits (3-0-0)

ELD453 BTP Part-II

8 Credits (0-0-16)

ELL453 Power System Dynamics and Control

3 Credits (3-0-0)

Characteristic of Generation units, Economic dispatch of thermal plants, Unit commitment, Hydrothermal coordination, Maintenance scheduling, Emission minimization, Optimal Power flow, Security constrained optimization, Optimization of distribution networks, Optimization in Power Markets.

ELD454 BTP Part-II

8 Credits (0-0-16)

ELL454 Special Topics in ET-I

3 Credits (3-0-0)

ELD455 BTP Part-II

8 Credits (0-0-16)

ELL455 Special Topics in V&ES-I

3 Credits (3-0-0)

Pre-requisite(s): to be decided by instructor

ELD456 BTP Part-II

8 Credits (0-0-16)

ELL456 Special Topics in NE&PS-I

3 Credits (3-0-0)

*Pre-requisite(s): to be decided by the instructor***ELD457 BTP Part II**

8 Credits (0-0-16)

ELL457 Special Topics in C&IS-I

3 Credits (3-0-0)

ELD458 BTP Part-II

8 Credits (0-0-16)

ELL458 Special Topics in CS&N-I

3 Credits (3-0-0)

ELD459 BTP Part-II

8 Credits (0-0-16)

*Pre-requisite(s): ELD411, ELD431***ELL459 Special Topics in IP-I**

3 Credits (3-0-0)

*Pre-requisite(s): to be decided by the instructor***ELL460 Special Topics in IP-II**

3 Credits (3-0-0)

*Pre-requisite(s): to be decided by the instructor***ELL700 Linear Systems Theory**

3 Credits (3-0-0)

Pre-requisite(s): ELL225 or equivalent

Review of matrix algebra, state variable modelling of continuous and discrete time systems, linearization of state equations, solution of state equations of linear time-invariant and time varying systems, Controllability and observability of dynamical systems, Minimal realization of linear systems and canonical forms, Liapunov's stability theory for linear dynamical systems, State Feedback controllers, Observer and Controller design.

ELV700 Special Module in Systems and Control

1 Credit (1-0-0)

Pre-requisite(s): to be decided by the instructor

To provide exposure in specialized topics in systems and control.

ELL701 Mathematical Methods in Control

3 Credits (3-0-0)

Linear Spaces – Vectors and Matrices, Transformations, Norms - Vector and Matrix norms, Matrix factorization, Eigenvalues and Eigenvectors and Applications, Singular Value Decomposition and its Applications, Projections, Least Square Solutions. Probability, Random Variables, Probability distribution and density functions, Joint density and Conditional distribution, Functions of random variables, Moments, characteristic functions, sequence of random variables, Correlation matrices and their properties, Random processes and their properties, Response of Linear systems to stochastic inputs, PSD theorem.

ELL702 Nonlinear Systems

3 Credits (3-0-0)

Pre-requisite(s): ELL225 or equivalent

Introduction to nonlinear systems: Examples of phenomena, models & derivation of system equations. Fundamental properties: Existence & uniqueness, Dependence on initial conditions & parameters.

Phase plane analysis. Limit cycles & oscillations. Describing function method and applications. Circle criterion. Lyapunov stability of autonomous systems. Perturbation theory & Averaging. Singular perturbation model and stability analysis. Basic results on Lie algebra. Controllability and Observability of nonlinear systems. Bifurcations. Chaos. Synchronization.

ELL703 Optimal Control Theory

3 Credits (3-0-0)

Pre-requisite(s): ELL700 or ELL333

Maximization of functionals of a single and several functions using calculus of variations, Constrained extremals, Euler-Lagrange Equation, Necessary conditions for optimal control, Pontryagin's minimum principle and state inequality constraints, Minimum time problems, Minimum control effort problems, Linear quadratic regulator problems, Riccati Equation, Singular intervals in optimal control problems, The principle of optimality, Application of the principle of optimality to decision making, Dynamic programming applied to routing problems, Solving optimal control problems using dynamic programming, Discrete linear regulator problem, Hamilton -Jacobi -Bellman Equation, Numerical Techniques to determine optimal trajectories.

ELL704 Advanced Robotics

3 Credits (3-0-0)

Pre-requisite(s): ELL225

Review of Coordinate Transformations, D-H parameters and kinematics. Velocity kinematics and Jacobian, Singularity analysis, Robot Dynamics. Motion planning, Robot control: linear methods – feedforward control, state feedback, observers; Nonlinear Control methods – Computed Torque Control, Feedback linearization, Sliding Mode control; Vision based Robotic Control. Holonomic and Non-Holonomic Systems, Mobile Robots : Modeling and Control, Odometry Analysis, Navigation problems with obstacle avoidance, motion capturing systems.

ELL705 Stochastic Filtering and Identification

3 Credits (3-0-0)

Pre-requisite(s): ELL701 or ELL333

MMSE estimation including LMS, Gaussian case. Wiener filtering & prediction. Kalman filtering & prediction. Extended Kalman filtering. Predictors for difference equation based models including ARMA, Box Jenkins & others. Statistical properties of Least Squares estimation and its relationship with Bayes estimation (ML, MAP), convergence analysis, CR bound. Recursive Least Squares, Iterative methods for nonlinear Least Squares. Identification problem: Different approaches for linear dynamical systems. Offline identification methods including Least Squares, Prediction error framework, Pseudo-linear regression (PLR) & Instrument variable methods. Recursive Identification of linear dynamical system: RLS, PLR, Prediction error framework & its application to ARMA & Innovations representation. Convergence Analysis of Recursive Identification methods: Associated ODE, Martingale. Nonlinear system identification. Subspace based method of system identification. Applications including LQG and adaptive control.

ELL706 Optimization for Electrical Engineers

3 Credits (3-0-0)

Convex analysis, Special convex optimization problems, convex optimization theory, Linear programming, unconstrained convex programming, Non-smooth convex optimization, constrained convex optimization, Structural optimization, online convex optimization, stochastic gradient descent, non-convex optimization.

ELL707 Systems Biology

3 Credits (3-0-0)

Pre-requisite(s): ELL225

MODELS : Variables and parameters, Law of mass action, Representations : Deterministic vs stochastic, Spatial aspects, Examples of core processes: Gene expression, Protein degradation, Phosphorylation.

DYNAMICS : Equilibrium solutions, Bifurcations, Switches, Bistability, Pulses and Oscillations, Circadian Rhythms and Clocks, Spatial patterns. Morphogenesis and Development.

CONTROL MECHANISMS : Performance Goals, Integral Feedback Control, Homeostasis and Perfect Adaptation, Bacterial Chemotaxis, Feedforward Loops, Fold Change Detection, Robustness to Perturbations, Tradeoffs, Internal Model Principle.

ELL708 Selected Topics in Systems and Control

3 Credits (3-0-0)

Pre-requisite(s): to be decided by the instructor

To be decided by the Instructor when floating this course: It can be anything that is related to systems and control engineering, but is not covered in any of the established courses.

ELL709 Design Aspects in Control

3 Credits (3-0-0)

System Modeling – model structures (Process model, ARX model), Review of concepts of stability, feedback and feedforward control. Classical control – First-Order Plus Dead-Time model (FOPDT), process reaction curves, Second-Order Plus Dead-Time model (SOPDT), relay feedback process identification; Smith Predictor and its variations, PID controllers and their tuning, Ziegler-Nichols and Cohen-Coon techniques.

Reliable State Feedback design – pole placement, eigenstructure assignment, region based eigenvalue assignment, eigenstructure-time response relationships. Controller gain selection – noise sensitivity. Controller robustness. Disturbance rejection. Frequency Domain Loop Shaping. Output feedback control – compensator design, review of Lead, Lag and Lag-Lead compensators, Zero dynamics – significance in servo control design, design for unstable zero dynamics. Observers – concept and design philosophy. Applications in practical controller design scenarios.

ELL710 Coding Theory

3 Credits (3-0-0)

Measure of information, Source coding, Communication channel models, Channel Capacity and coding, Linear Block codes, Low Density Parity Check (LDPC) Codes, Bounds on minimum distance, Cyclic codes, BCH codes, Reed Solomon Codes, Convolutional codes, Trellis coded Modulation, Viterbi decoding, Turbo codes, Introduction to Space-Time Codes and Introduction to Cryptography. If time permits, LDPC/Turbo codes in the wireless standards. There are no laboratory or design activities involved with this course.

ELV710 Special Module in Cyber Security

1 Credit (1-0-0)

Overview of cyber security, computer security and the associated threat, attack, adversary models, access control, intrusion detection, basic network security, security of cyber physical systems and a brief introduction to cryptography.

ELL711 Signal Theory

3 Credits (3-0-0)

Pre-requisite(s): ELL205, ELL311

Discrete random variables (Bernoulli, binomial, Poisson, geometric, negative binomial, etc.) and their properties like PDF, CDF, MGF.

Continuous random variables: Gaussian, multivariate Gaussian; whitening of the Gaussian random vector; complex Gaussian random vector, circularity; Rayleigh and Rician; exponential; chi-squared; gamma.

Signal spaces: convergence and continuity; linear spaces, inner product spaces; basis, Gram-Schmidt orthogonalization.

Stochastic convergence, law of large numbers, central limit theorem. Random processes: stationarity; mean, correlation, and covariance functions, WSS random process; autocorrelation and cross-correlation functions; transmission of a random process through a linear filter; power spectral density; white random process; Gaussian process; Poisson process.

ELL712 Digital Communications

3 Credits (3-0-0)

Review of random variables and random process, signal space concepts, Common modulated signals and their power spectral densities, Optimum receivers for Gaussian channels, Coherent and non-coherent receivers and their performance (evaluating BER performance through software tools), Basics of Information theory, source and channel coding, capacity of channels, band-limited channels and ISI, multicarrier and spread-spectrum signaling, multiple access techniques.

ELL713 Microwave Theory and Techniques

3 Credits (3-0-0)

Pre-requisite(s): ELL212

Overlaps with: CRL711

Review of EM theory: Maxwell's equations, plane waves in dielectric and conducting media, energy and power. Transmission lines and waveguides: closed and dielectric guides, planar transmission lines and optical fibre. Network analysis: scattering matrix other parameters, signal flow graphs and network representation. Impedance matching and tuning. Analysis of planar transmission lines. Analysis of design of passive components.

ELL714 Basic Information Theory

3 Credits (3-0-0)

Pre-requisite(s): ELL205

Introduction to entropy, relative entropy, mutual information, fundamental inequalities like Jensen's inequality and log sum inequality. Proof of asymptotic equipartition property and its usage in data compression. Study of entropy rates of the stochastic process following Markov chains. Study of data compression: Kraft inequality and optimal source coding. Channel capacity: symmetric channels, channel coding theorem, Fano's inequality, feedback capacity. Differential entropy. The Gaussian channel: bandlimited channels, channels with colored noise, Gaussian channels with feedback. Detailed study of the rate-distortion theory: rate distortion function, strongly typical sequences, computation of channel capacity. Joint source channel coding/separation theorem. There are no laboratory or design activities involved with this course.

ELL715 Digital Image Processing

4 Credits (3-0-2)

Introduction to 2-D Signals and Systems. Image Digitization. Image Transforms. Image Enhancement: Image Restoration: Inverse Filtering, Algebraic Approach to Restoration, Wiener (LMS) approach, Constrained Least Squares Restoration, Adaptive methods for restoration. Image Reconstruction: The Filtered Back- Projection Algorithm, Algebraic Reconstruction Method. Image Segmentation: Detection of Discontinuities, Edge Linking and Boundary Detection, Thresholding, Region-Oriented Segmentation. Object representation and description: Boundary descriptors, region descriptors, HOG and SIFT based features. Colour Image processing: colour models, colour transformations, and processing techniques.

ELL716 Telecommunication Switching and Transmission

3 Credits (3-0-0)

Wireline access circuits, long haul circuits, signaling, switching exchanges, analysis of telecom switching networks, teletraffic engineering, management protocols, multi-service telecom protocols and networks.

ELL717 Optical Communication Systems

3 Credits (3-0-0)

The fiber channel with its linear and nonlinear characteristics, LED and Laser diode transmitter design, PIN and APD receiver design, Modulation schemes, Source and line coding in optical systems. Optical Link design with dispersion and power budgeting. Design of digital and analog communication systems. Optical amplifiers, WDM system design. Hybrid fiber co-axial/microwave links.

ELL718 Statistical Signal Processing

3 Credits (3-0-0)

Pre-requisite(s): ELL711

Review of random variables, GS orthogonalization, geometric concepts, notions of projection, random processes, WSS processes, properties of autocorrelation and power spectral densities, properties of autocorrelation matrices, Cholesky decomposition, eigen-analysis, optimum Linear filtering, LMS and its performance, variants, Least-squares, QR decomposition and SVD, RLS and its performance, square-root RLS, Kalman Filters, spectrum modelling.

ELP718 Telecommunication Software Laboratory

3 Credits (0-1-4)

Contents: CASE tools, object-oriented program development, use of telecom network simulator, implementation using C/C++/Java, network management software design, V.5 test and simulation.

ELL719 Detection and Estimation Theory

3 Credits (3-0-0)

Pre-requisite(s): ELL711

Overview of the course, Classical Decision Theory: Binary hypothesis testing: Bayes criterion, Neyman-Pearson criterion, min-max test, M-ary hypothesis testing: General rule, minimum probability of error decision rule, Gaussian case and associated geometric concepts, Erasure decision problem, Random parameter estimation. Non – random parameter estimation: CRLB for nonrandom parameters, ML estimation rule, asymptotic properties of ML estimates. Linear minimum variance estimation, Least squares methods CRLB for random parameter estimation, condition for statistical efficiency, Multiple parameter estimation, Composite and non-parametric hypothesis testing, Applications, Detection of signals.

Mathematical preliminaries: K-L expansion and its application to Detection of known and un-known (i.e. with unknown, parameters) signals in AWGN., Detection of signals in colored noise. Linear estimation, Wiener filters and solution of Wiener Hopf Equations, Kalman-Bucy filters, Miscellaneous estimation techniques.

ELP719 Microwave Laboratory

3 Credits (0-1-4)

Design, fabrication and testing of simple linear microwave circuits using microstrip technology.

ELL720 Advanced Digital Signal Processing

3 Credits (3-0-0)

*Pre-requisite(s): ELL205**Overlaps with: ELL319*

Review of Signals and Systems, Sampling and data reconstruction processes.

Z transforms.

Discrete linear systems.

Frequency domain design of digital filters.

Quantization effects in digital filters.

Discrete Fourier transform and FFT algorithms.

High speed convolution and its application to digital filtering.

Introduction to Multirate signal processing, Multirate filtering and Filterbanks: including Polyphase decomposition and perfect reconstruction, Cyclostationarity and LPTV filters, Introduction to Wavelet Transform.

The self-study component will consist of design problems in the above to be implemented on MATLAB.

ELP720 Telecommunication Networks Laboratory

3 Credits (0-1-4)

Contents: Development of network elements such as routers, SNMP nodes. Use of laboratory and telecom field test instruments such as: oscilloscopes, oscillators, RMS meters, transmission impairment

measuring systems, return loss meters, etc. Enables students to study voice and data switching functions and to measure transmission and traffic characteristics on models of the major business communication systems and carrier transmission facilities (controlled LAN environments, Ethernet, E1, T1/T3lines). Experimental procedures include the use of frequency and time division multiplex systems and the modulation techniques employed by in such systems and the observation of noise and distortion effects.

ELV720 Special Module in Communication Systems and Networking-I

1 Credit (1-0-0)

ELL721 Introduction to Telecommunication Systems

3 Credits (3-0-0)

*Pre-requisite(s): Only for MBA students of Bharti School, Audit for**others*

Fundamentals of signals, signal transmission and media, modulation techniques, equalization, amplification, crosstalk, attenuation, switching principles, telephony, signaling, transmission systems-DSL, optical, radio.

ELP721 Embedded Telecommunication Systems Laboratory

3 Credits (0-1-4)

ELL722 Antenna Theory and Techniques

3 Credits (3-0-0)

Review of electromagnetism and vector calculus, history and context of antenna theory, operation of various antenna types, such as dipole, linear, loop, and resonant type, characterization of antenna performance metrics, and introduction to numerical techniques for visualizing antenna radiation patterns.

ELL723 Broadband Communication Systems

3 Credits (3-0-0)

Multiple Access Techniques – CSMA, Spread Spectrum (SS), Direct Spread SS, Frequency Hopping SS and CDMA, Timing Synchronization, Delay Lock Loop, ISDN Physical Layer, ISDN Data Link Layer, Signaling System Number 7, Broadband ISDN Protocols, ATM Switch and Protocols, CLOS Network Switch, OFDM Concept, OFDMA System, Multi-Carrier CDMA, WiMAX.

ELL724 Computational Electromagnetics

3 Credits (3-0-0)

ELL725 Wireless Communications

3 Credits (3-0-0)

Pre-requisite(s): ELL712

The wireless channel (physical modeling, linear time-varying system, discrete-time baseband model, time and frequency coherence), point-to-point communication (detection, diversity, spatial multiplexing), cellular systems (multiple access and interference management), capacity of point-to-point wireless channels (single and multi-antenna), capacity of single-antenna multiuser channels, point-to-point multi-antenna (MIMO) channels and spatial multiplexing, point-to-point MIMO capacity and multiplexing architectures.

ELP725 Wireless Communication Laboratory

3 Credits (0-1-4)

EL.L726 Nano-Photonics and Plasmonics

3 Credits (3-0-0)

EM Waves, Maxwell's Equations, Boundary Conditions, Drude, Debye, Lorentz-Drude Dispersion Relation Models, Introduction to Surface

Plasmons, Surface Plasmon Excitation Mechanisms, Plasmonic Nanogratings, Localized Surface Plasmon based Devices, Optical and Plasmonic Interconnects, Sensors based on Surface Plasmons, SERS based sensing, Photonic Crystals, Optical Metamaterials, Fabrication of Nanomaterials and Plasmonic Devices.

ELL727 Digital Communication and Information Systems

3 Credits (3-0-0)

Review of Fourier Transforms, Sampling Theorem, Quantization, Pulse Code Modulation, Digital Modulation Schemes – BPSK, QPSK, BFSK, QASK, MPSK, Random Processes, Probability density function, Gaussian density function, Frequency domain representation of noise, Spectral components of noise, Noise bandwidth, Properties of noise, Noise Performance Analysis of digital modulation schemes. Information Theory, Concept of information, Coding to increase average information per bit, Shannon's theorem, Capacity of Gaussian Channel, Bandwidth-S/N tradeoff. Discrete memory-less channel capacity. Error correcting codes, Block codes, Cyclic redundancy check, Coding gain, Bit error rate calculations.

ELL728 Optoelectronic Instrumentation

3 Credits (3-0-0)

Introduction to test and measuring instruments, instrumentation amplifier, chopper stabilized amplifier, analog signal processing: active filter, A/D, D/A converters, integrated, transimpedance and low impedance pre-amplifiers design, sample & hold circuits, multiplexer, peak detector, zero crossing detector etc., digital design: PALs, FPGA, signal analyzer: superheterodyne spectrum analyzer, DFT and FFT analyzer, digital filters and computer interface, microcontrollers: introduction to microcontroller and applications such as 8031, optical post, in-line and pre-amplifiers, noise figure, optoelectronic circuits: transmitter and receiver design, OTDR, optical spectrum analyzer, sensors: fiber optic and radiation types, distributed sensors, fiber optic smart structure, display devices.

ELL729 Stochastic Control and Reinforcement Learning

3 Credits (3-0-0)

Basics of dynamic programming, Finite horizon MDP with quadratic cost, Optimal stopping problems, Partially observable MDP, Infinite horizon discounted cost problems, Stochastic shortest path problems, Undiscounted cost problems, Average cost problems, Semi-Markov decision process, Constrained MDP, Basics of stochastic approximation, Kiefer-Wolfowitz algorithm, Simultaneous perturbation stochastic approximation, Q learning and its convergence analysis.

ELL730 I.C. Technology

3 Credits (3-0-0)

Course Introduction, Modern Semiconductor IC fabrication Industrial/Academic Landscape; Overview of modern CMOS process flow – basic steps; Crystal growth and wafer basics; Cleanroom basics – environment, infrastructure, advanced MOS cleaning, gettering etc.

Lithography; Oxidation; Diffusion; Ion-Implantation; Thin-Film Deposition; Etching; Backend processes; Process Simulation- tools, techniques and methods; Advanced device fabrication concepts – I (SOI, FDSOI, etc); Advanced device fabrication concepts – II (organic, PV, hetero); Advanced device fabrication concepts – III (CNTs, Self-assembly etc).

ELV730 Special Modules in V&ES – I

1 Credit (1-0-0)

Pre-requisite(s): to be decide by instructor

ELL731 Mixed Signal Circuit Design

3 Credits (3-0-0)

Pre-requisite(s): ELL782

Switched capacitor circuit principles and applications in filter design; issues of clock feed through, charge injection and other non-idealities;

design of switches; data converters: characteristics, static and dynamic; types of ADCs; track and hold, and sample and hold circuits; comparators; flash ADCs; pipelined ADCs; successive approximation register type ADCs; discrete-time and continuous time delta-sigma ADCs; higher order delta-sigma design; MASH structure; multi-bit delta-sigmas; decimation filtering – sinc and comb filters; digital to analog conversion; voltage-based DACs; charge-based DACs; current-based DACs – binary and thermometer currents; linearizing techniques for DACs; delta-sigma DACs; interpolation filtering; phase-locked loop basics; PLL dynamics; frequency synthesis; all-digital PLLs.

ELV731 Special Modules in NE&PS – I

1 Credit (1-0-0)

Pre-requisite(s): to be decided by the instructor

ELL732 Micro and Nanoelectronics

3 Credits (3-0-0)

Technology basics and digital logic families such as static CMOS, pass transistor, transmission gate, dynamic and domino logic. Advanced sequential logic elements with latch-based design and timing and clocking concepts. Power and delay of digital circuits. Physical and logical synthesis for ASICs and FPGAs. Verilog and VHDL with design examples. Design for testability with fault models.

ELL733 Digital ASIC Design

4 Credits (3-0-2)

Pre-requisite(s): ELL308

Overlaps with: CSL316

Review of working of MOSFET, large signal and small signal models, biasing schemes, analysis and design of various single stage amplifier configuration, Noise and distortion analysis, Mismatch and non-linearity, low and high frequency analysis of single stage amplifiers, frequency compensation, current mirrors and reference circuits, multistage amplifiers; differential and operational amplifiers, negative and positive feedback, oscillators and power amplifiers.

ELL734 MOS VLSI design

3 Credits (3-0-0)

Digital integrated circuit design perspective. Basic static and dynamic MOS logic families. Sequential Circuits. Power dissipation and delay in circuits. Arithmetic Building blocks, ALU. Timing Issues in synchronous design. Interconnect Parasitics.

ELV734 Special Module in Scientific Writing for Research

1 Credit (1-0-0)

Tools needed for scientific writing, ethics of publication, plagiarism, attribution, copyrights, writing impactful papers, writing theses, writing a technical disclosure or patent.

ELL735 Analog Integrated Circuits

3 Credits (3-0-0)

Pre-requisite(s): ELL304

Introduction to MOSFETs, Single stage amplifiers, Biasing circuits, Voltage and Current reference circuits, Feedback analysis, Multistage amplifiers, Mismatch and noise analysis, Differential amplifiers, High speed and low noise amplifiers, Output stage amplifiers, Oscillators.

ELL736 Solid State Imaging Sensors

3 Credits (3-0-0)

Pre-requisite(s): ELL304, ELL782

Radiometry and Photometry (Light radiation, photometry, light source, light units), Introduction to properties of silicon and photon absorption, Imager formats, Basics of image sensors (fundamental definition of image sensors, pixels, photo-conversion principles, Charge coupled devices (operational principles, types and performance metrics), CMOS image sensors (operational principles, types and performance metrics), Noise, quantum efficiency, dynamic range and modulation

transfer function analysis in image sensors, High speed image sensors, Back side illumination, Electron multiplication CCDs and CMOS, Colour detection in silicon, 3D imaging, machine vision cameras, polarization detection and scientific applications.

ELP736 Physical Design Laboratory

3 Credits (0-0-6)

ELL737 Flexible Electronics

3 Credits (3-0-0)

Pre-requisite(s): ELL218, ELL111, or ELL732 or equivalent

Introduction to displays and lighting technologies, solar cells, and sensors. Flexible substrates. Low cost materials. Solution-processed fabrication methods. Printing methods. Flexible displays. Flat panel lighting. Flexible solar cells. Low-cost sensors.

ELL738 Micro and Nano Photonics

3 Credits (3-0-0)

Pre-requisite(s): PYL101

Overlaps with: PYL795

Ray Optics; Wave Optics: Plane Waves, Spherical Waves, Interference, Diffraction; Paraxial Waves; Beam Optics; Fabry Perot Cavity; Microresonators - Ring Resonators, Disc Resonators; Review of Electromagnetic (EM) Theory; Boundary Conditions; and some relevant EM problems; FDTD and FEM modeling; Fundamentals of Plasmonics - Surface Plasmon Resonance, Dispersion relation, Plasmon coupling conditions, Plasmonic gratings, Models describing the refractive index of metals; Localized Surface Plasmon Resonance; Plasmonic Sensors and Devices; Surface-enhanced Raman Scattering; Plasmonic waveguides and Interconnects; Photonic Crystals and Devices.

ELL739 Advanced Semiconductor Devices

3 Credits (3-0-0)

Pre-requisite(s): ELL732(PG)

Solid state device physics, generation and recombination processes, radiation basics, density of states, gain and absorption, LEDs, OLEDs, heterojunction LEDs, lasers, population inversion, photodetectors, CCDs, image sensors, photocurrent, solar cells, efficiency measures, multijunction PVs, organic solar cells, economics, memory devices, sensors, MEMS devices.

ELL740 Compact Modeling of Semiconductor Devices

3 Credits (3-0-0)

Pre-requisite(s): Any course on MOS devices or Microelectronics or Physical Electronics or VLSI technology

Introduction to AMS enablement and PDK elements, Basics of semiconductor devices, Device modeling tools-TCAD and SPICE, Diode modeling, Resistor modeling, FEOL capacitor modeling, Advanced CMOS Technology, MOS transistor modeling, modeling of process variations, Mismatch and corners.

ELL741 Neuromorphic Engineering

3 Credits (3-0-0)

Motivation and field Introduction, Emerging computing trends and roadmap, non-von Neumann computing approach; Basic Biology - 1: Neuron, Synapse, Synaptic Plasticity; Basic Biology -2 : Learning rules, Retina, Cochlea, STDP; Mathematical/Electrical modeling of Neurons - LIF, IF, HH; Hardware Implementation of Neuron circuits - VLSI Digital/Analog; Advanced Nanodevices for Neuron Implementation; Hardware Implementation of Synaptic and Learning circuits - VLSI Digital/Analog; Advanced Nanodevices for Synaptic emulation - 1 (NVM, Flash etc); Advanced Nanodevices for Synaptic emulation - 2 (RRAM, memristors, CNT etc); Synaptic programming methodology optimization; Nanodevice specific bio-inspired learning rule optimization; Full Network design example -1: Visual Application; Full Network design example -2: Auditory Application; Full system level power/energy dissipation considerations and course conclusion.

ELL742 Introduction to MEMS Design

3 Credits (3-0-0)

Overlaps with: CRL726

This course is an introduction to the multi-disciplinary and rapidly growing area of MEMS. A MEMS design engineer requires knowledge of several domains -namely mechanical, electrical, fluidic and thermal, as well as knowledge of circuits and microfabrication techniques. This course will cover the fundamentals as applicable to MEMS, as well as several case studies to understand the design process.

ELL743 Photovoltaics

3 Credits (3-0-0)

Pre-requisite(s): ELL218, ELL111(UG), ELL732(PG)

Overlaps with: ELL739

Solid state device physics, p-n and p-i-n junctions. Homojunctions and heterojunctions. Generation and recombination processes. Radiation basics. Photon absorption. Photovoltaic efficiency. Thin film fabrication processes. Silicon-based solar cells. III-V and chalcogenide-based solar cells. Multijunction architectures. Dye-sensitized solar cells. Organic solar cells. Plasmonic structures. Solar cell economics and policy.

ELL744 Electronic and Photonic Nanomaterials

3 Credits (3-0-0)

1D, 2D and 3D confinement; Density of states; Excitons; Coulomb blockade; Optical properties of semiconducting nanoparticles; Fluorescence of semiconductor nanocrystals, core-shell nanocrystals, effect of nanocrystal size; Optical properties of metallic nanoparticles: Surface Plasmons, Localized Surface Plasmons, Surface-enhanced Raman scattering; Electronic Applications of Nanomaterials: Nanowire transistors, Memory Devices, Single electron devices, Biosensors; Optical Applications of Nanomaterials - Quantum well, wire, and dot Diodes, Lasers and Detectors, Chemical sensors, Gas sensors, Biosensors; Development of Electronic and Optical Nanomaterials: Epitaxial Growth, Deposition of Nanomaterials, Self-Assembly of Nanomaterials, Nanofabrication techniques; Characterization of Nanomaterials: Electron microscopic techniques (scanning and transmission), Atomic Force Microscopy, X-Ray Diffraction, Characterization of optical and electronic properties of nanomaterials.

ELL745 Quantum Electronics

3 Credits (3-0-0)

Pre-requisite(s): ELL732(PG)

Overlaps with: ELL739

Newtonian mechanics, wavepackets, brief history of quantum mechanics, blackbody radiation, photoelectric effect, wave-particle duality, second quantization, Semiconductor materials, crystal structure and defects, Bravais lattices, Brillouin zones, Miller indices, periodic potentials, Kronig-Penney model, bandstructure in bulk semiconductors, Bloch theorem, direct and indirect bandgap semiconductors, effective mass, effect of alloying, carrier statistics, superlattices and quantum wells, density of states in 0,1,2 and 3 dimensions, bandstructure in lower dimensional systems, heterojunctions, effect of strain on bandstructure, excitonic effects in semiconductors, tunneling, perturbation theory, scattering and collisions, phonons, high-field transport, Boltzmann transport theory, spin transport, excitons, optical processes in semiconductors and quantum wells, absorption, gain, spontaneous and stimulated emission, fluorescence and phosphorescence, photophysics of organic molecules and polymers.

ELL746 Biomedical Electronics

3 Credits (3-0-0)

Introduction to Biomedical Instrumentation: Constraints, Regulations and health economics, Basic sensors, amplifiers and signal processing, Origin of bio potentials and electrode systems, Bio potential amplifiers,

sources of noise and their Remedies, Blood pressure and heart sound systems, Measurement of flow and volume of blood Measurement of respiratory system, Ultrasonography, CAT, PET and MRI overview, Fuzzy Logic and its application medical instruments, Embedded system in medical electronics with selection of one microprocessor and then design tips, Overview of pace maker, defibrillator, hemodialysis and infant incubators. Safety codes and standards, Electro-chemical sensor, Ion Selective FET, Immunologically sensitive FET, Spectrophotometry, Optical biosensors, Fibre-optic sensors, blood glucose sensor, smell sensor, SAW devices, Sensor neural network, Expert systems and case studies of design examples.

ELL747 Active and Passive Filter Design

3 Credits (3-0-0)

Pre-requisite(s): ELL202 or circuit theory

Review of network theorems such as reciprocity, Tellegen's theorem, scattering parameters, properties of lossless passive networks; Butterworth approximation; Chebyshev approximation; synthesis of Butterworth and Chebyshev filters; odd versus even order filters; sensitivity of lossless LC ladder filters; frequency transformations; inverse Chebyshev and elliptic approximations; synthesis of inverse Chebyshev and elliptic filters; review of properties of p.r. functions; Darlington synthesis; signal flow graphs of ladder filters; opamp-RC implementation; Gm-C implementation; switched-capacitor implementation; minimum required performance of active components; tuning of filters; transmission line based filters: using high-Z low-Z technique, using Kuroda's identities; bi-quad based design approaches and drawbacks; Tow-Thomas biquad, Sallen-Key biquad.

ELL748 System-on-Chip Design and Test

3 Credits (3-0-0)

Pre-requisite(s): ELL201

Overview and definition of power quality (PQ), Sources of pollution, International power quality standards, and regulations. Power quality monitoring. Power quality problems. Loads which causes power quality problems.

Power factor correction, zero voltage regulation, reactive power compensation, load balancing using load compensation techniques: passive shunt and series compensation, DSTATCOM (Distribution Static Compensators), DVR (Dynamic Voltage Restorers), UPQC (Universal Power Quality Conditioners).

Harmonic effects-within the power system, interference with communication Harmonic measurements. Harmonic elimination-using active (shunt, series and hybrid) and passive (shunt and series) filters. Improved power quality converters: single ac-dc converters, bridgeless isolated converter, bridgeless non-isolated converters, multi-pulse converters, multilevel converters, line commutated converters, power quality improvement in SMPS, UPS, drives, welding systems, lighting systems, and renewable energy systems.

ELL749 Semiconductor Memory Design

3 Credits (3-0-0)

Pre-requisite(s): ELL734

ELL750 Modelling of Electrical Machines

3 Credits (3-0-0)

Pre-requisite(s): ELL203

Review of dynamic Modeling of systems, Basic concepts of electromechanical energy conversion, Modeling of Transformer, Generalized Theory of Electrical machines, Modeling of DC Machine, Induction Machine, Wound Field Synchronous machine, and special machines such as BLDC, PMSM etc.

ELV750 Special Modules in AE-I

1 Credit (1-0-0)

ELL751 Appliance Systems

3 Credits (3-0-0)

Pre-requisite(s): ELL203, ELL332 ELL365

Introduction to Domestic Appliances, Embedded System Design issues, Ergonomic Design aspects, Review of Electrical Machines and Drives, Review of Embedded Systems, Drive and Control of Washing Machines, Refrigerators, Air Conditioners, Mixer-Grinders/ Food Processors, Ceiling and other types of Fans, Introduction to Industrial Appliances, Drives and Control of Industrial Appliances, Computer Aided Simulation and Design of Drives and Control of Appliances, Smart Appliances.

ELL751 Power Electronic Converters

3 Credits (3-0-0)

Introduction to various power switching devices and their control, introducing various power electronic circuits for realization of AC-DC, AC-AC, DC-AC, DC-DC conversion, principle of operation, and analysis, pulse-width modulation and pulse frequency control of power electronic converters, design problems on power electronic converter systems.

ELL752 Electric Drive System

3 Credits (3-0-0)

Components of electric drive system- electrical machines, power converters and control system. Different types of loads encountered in modern drive applications. dynamics of drive systems, starting, braking, speed-control, steady-state and dynamic operation of motors, load variations, closed loop control of drives, phase controlled and chopper controlled dc drives, induction motor drives, synchronous motor drives, space phasor model, v/f control, direct and indirect vector control, direct torque control, PMSM drives, BLDC drive, drive controller design.

ELV752 Special Modules in EET-I

1 Credit (1-0-0)

ELL753 Physical Phenomena in Electrical Machines

3 Credits (3-0-0)

Engineering and physical aspects of rotating machines. Modern machine windings. Winding analysis and mmf waveforms. Space and time harmonics. Saturation. Unbalanced magnetic pull and magnetic noise in industrial machines. Heating/Cooling. Unbalanced and asymmetrical operation of induction motors. Special phenomena in electrical machines such as capacitor self excitation of induction machines and its applications. Use of electromagnetic field theory, performance of permanent magnet machines. Magnetic levitation Superconductors and applications. Permanent magnet and Switched Reluctance Motors.

ELV753 Special Modules in ET-I

1 Credit (1-0-0)

ELL754 Permanent Magnet Machines

3 Credits (3-0-0)

Introduction to Permanent Magnet Machines, Permanent Magnet DC Commutator Machines, Permanent Magnet Synchronous Machines, Permanent Magnet Brushless DC machines, Hysteresis motors, Stepper Motors. Various applications of permanent magnet machines in field of robotics, solar pumping, wind energy generation system and others. Computer aided simulation studies for modeling and performance analysis of these drive systems.

ELL755 Variable Reluctance Machines

3 Credits (3-0-0)

Design, modeling, construction, operation and control of variable reluctance machines including hybrid motors and their applications. Distinguishing factors between the variable reluctance machines

and various conventional machines. Study of possible replacement of conventional machines by the variable reluctance machines for specific applications. Applications of reluctance machines in robotics, renewable energy systems & Electric vehicle.

ELL756 Special Electrical Machines

3 Credits (3-0-0)

Pre-requisite(s): ELL103

Introduction to Special Electrical Machines and Magnetic Devices, Permanent Magnet Machines, Permanent Magnet Brushless DC Machines, Permanent Magnet Brushless Synchronous Machines, Stepper Motors, Hysteresis Motors, Switched Reluctance Motors, Hybrid Motors, Linear Machines, Magnetic Devices, Applications in Robotics, Industry Automation, Electric Vehicles, Aerospace and Defense Systems, etc., Super conducting Machines, Writen Pole Machines, Micro-motors, PCB motors, Case Studies, Computer Aided Simulation and Design of Special Electrical Machines.

ELL757 Energy Efficient Motors

3 Credits (3-0-0)

Introduction to energy efficiency and its impacts on social life. Energy-efficient motors, fundamentals of electric motor drives, power factor under non sinusoidal conditions, energy efficient induction motor under different input parameters and applications, adjustable-speed drives their advantages and benefits from efficiency point of view, case studies related to induction motor variable speed drive system, brushless dc motor drive, switched reluctance motor drives, permanent magnet synchronous motor drive etc.

ELL758 Power Quality

3 Credits (3-0-0)

Overview and definition of power quality (PQ), Sources of pollution, International power quality standards, and regulations. Power quality monitoring. Power quality problems. Loads which causes power quality problems. Power factor correction, zero voltage regulation, reactive power compensation, load balancing using load compensation techniques: passive shunt and series compensation, DSTATCOM (Distribution Static Compensators), DVR (Dynamic Voltage Restorers), UPQC (Universal Power Quality Conditioners). Harmonic effects-within the power system, interference with communication Harmonic measurements. Harmonic elimination-using active (shunt, series and hybrid) and passive (shunt and series) filters. Improved power quality converters: single ac-dc converters, bridgeless isolated converter, bridgeless non-isolated converters, multi-pulse converters, multilevel converters, line commutated converters, power quality improvement in SMPS, UPS, drives, welding systems, lighting systems, and renewable energy systems.

ELL759 Power Electronic Converters for Renewable Energy Systems

3 Credits (3-0-0)

Current status and future developments in renewable energy. Requirements for solar and wind power generation from the grid. Solar Power – PV system configurations, Solar cell technologies, Maximum power point tracking, Photovoltaic Inverters different types of topologies and control strategies. Wind power – Wind power energy system, types of wind turbines- fixed speed and variable speed, different types of converters – AC-DC-AC converters, matrix converters, multilevel converter, control of converters. Fuel cells and battery energy storage systems. Grid synchronization and PLL, Grid regulations. Islanding operation. Control of converters for fault operation. Filter design. Relevant IEEE and IEC standards for renewable energy systems.

ELL760 Switched Mode Power Conversion

3 Credits (3-0-0)

To give an introduction about the power switching devices such as Thyristors, GTO, MOSFETS, BJT, IGBT and MCTS. Basic concept of gate drivers (Trigger techniques, optical isolators, protection circuits,

and isolation transformers), snubber design and protection schemes of power devices are to be discussed. Basic circuit configurations, design and analysis of choppers (step-up, step-down, step-up/down and multi-phase choppers), DC-DC converters (non-isolated and isolated), inverters (voltage and current source and multi-level configurations) are discussed. This is followed by improved power quality converters (non-isolated and isolated) for reduction of harmonics at AC mains.

ELL761 Power Electronics for Utility Interface

3 Credits (3-0-0)

Overview of power electronic converters for utility applications, Converter requirements for Grid-interface, Harmonic compensation, Instantaneous power theory, STATCOM and active filtering and Control of converters under grid-faults.

ELL762 Intelligent Motor Controllers

3 Credits (3-0-0)

Pre-requisite(s): ELL332

Fundamental concepts in control of electric drive systems. Intelligent Control algorithms used for electric drive systems. Application of Fuzzy Logic, Neural Networks, Genetic Algorithm, Hybrid Fuzzy and Nonlinear Control of Power Converters and Drives. Other recent topics on Intelligent Control of Drives.

ELL763 Advanced Electric Drives

3 Credits (3-0-0)

Pre-requisite(s): ELL332

Types of Controllers: Proportional-Integral Control, Hysteresis Control etc, Advanced DC Drives: Cascaded Control Loop Structure, Control Loop Design etc, Control of BLDC drive: Modeling and Control of BLDC Drive, Review of Power Converter and Modulation Techniques: Modeling of Power Converters, Sinusoidal Pulse-Width Modulation, Space Vector Pulse-Width Modulation, Field Oriented Control (FOC) of AC Machines: Generalized Space-Phasor Model of AC Machines in different Flux Frames of References, Control Principle, FOC of Permanent Magnet Synchronous Machine (PMSM), FOC of Squirrel Cage Induction Machine (SQIM), Direct Torque Control (DTC) of AC Machines: Control Principle, DTC of Squirrel Cage Induction Machine (SQIM).

ELL764 Electric Vehicles

3 Credits (3-0-0)

Fundamental issues related to electric vehicles (EVs) and hybrid electric vehicles (HEVs); Various brushless motors such as PMSM, PMBLDCM, SRM, synchronous reluctance motor, induction motor for EVs. Various types of chargers and energy management strategies. Analysis and simulation of EV systems. Various design and control aspects of electric drives and chargers for EVs and HEVs.

ELL765 Smart Grid Technology

3 Credits (3-0-0)

Introduction:- Smart Grid an Overview; Components of Smart Grid; Intelligent Appliances; Smart Substations; Smart Distributions-Generations; Smart Power meters; Universal Access (wind, solar, hydro etc.) Smart Grid Technologies: Integrated Communications; Sensing and Measurement; Advance Control Methods; Advance components and Improved Interfaces and Decision Support. Benefits of Smart Grid: Self-Healing; Power Quality Improvement; Utilization of all generation and storage options; Optimized use of assets and efficient Operation. Miscellaneous: Smart Grid Challenges; Smart Grid Projects; Contribution of Microgrid in development of Smart Grid.

ELL766 Appliance Systems

3 Credits (3-0-0)

Pre-requisite(s): ELL203, ELL332 ELL365

Overview of appliance systems, international standards and regulations, energy efficient appliances, energy efficiency in motor

driven appliances, classification based on power rating: low, medium, and high power appliances, classification based on supply power: single-phase and three-phase, classification based on drives system, heating systems and renewable system.

To understand the various types of appliance systems used in domestic and office or commercial scenarios.

Low power appliances (working, types, power quality problems, numerical examples): laptops, mobile, fans, lighting system(CFL, LED, solar), water pumps, TV (LCD, LED Plasma), UPS, SMPS, computer, printer, scanner, hair drier, trimmer, electric rice cooker, induction heater, solar cooker, electric iron, micro-oven, drillers etc.

Medium power appliances (working, types, power quality problems, numerical examples): Air conditioner, electrical vehicle, centralized heating system, washing machines, refrigerators, welding system, solar boiler, water pumps etc.

High power appliances (working, types, power quality problems, numerical examples): welding machines, hammers, centralized AC system, etc.

Power quality techniques used in appliances systems.

ELL767 Mechatronics

3 Credits (3-0-0)

Introduction to mechatronics systems. Various parts of mechatronics systems. Analog-to-digital-conversion (A/D) and its implementation using a microcontroller and DSPs. Study of the underlying operational principles and construction of electromagnetic actuators such as DC, AC, and stepping motors. Study of various transducers their working principles. Selection of best electrical machines for a given motion control application considering system inertia, external forces or torques, and motion profiles. Design and analysis for basic power controllers for various applications.

ELL768 Computer Aided Design of Power Electronic Systems

3 Credits (3-0-0)

Introduction to modern simulation tools used for the power electronic systems analysis such as PSPICE, MATLAB, PSIM, SABER etc. Modeling of power electronic systems, filters designs. Introducing to advanced modeling techniques and their transformation into software platform, Closed-loop power electronic systems modeling and their simulation.

ELL769 Electrical Systems for Construction Industries

4 Credits (3-0-2)

Elements of Distribution System: Distribution transformer circuit breakers, Cables, Fuses and protection schemes, Rectifiers, Battery chargers and inverters. Machines and Drives: D.C. Motors, 3-phase induction motors and FKW motors starting, speed control and braking, Application to air conditioning, lifts, cranes, water pumps. Illumination: Types of illumination, illumination laws, lamps & fixtures. Electrical Energy Conservation: Modern compact fluorescent lamps, energy audit methods of saving electricity in drives, lighting, air conditioning, pumps and distributions systems metering, KW, KWh and KVAR meters stand by power generation: DG sets, UPS, maintenance and protection of D.G. sets and UPS.

ELL770 Power System Analysis

3 Credits (3-0-0)

Pre-requisite(s): ELL303

Revision of Basic Concepts in pu and modeling, Admittance model of transmission network, Power Flow solutions (GS, NR, DLF, FDLF, DCLF), Symmetrical components and sequence networks, Faults - Symmetrical and unsymmetrical, Z Bus building algorithms, State Estimation, Voltage Stability, Continuation Power Flow, Power System Security (Overload, Voltage), Introduction to WAMS and PMUs, Linear State Estimation.

ELL771 Advanced Power System Protection

3 Credits (3-0-0)

Fundamentals of protection, generator protection, transformer

protection, bus bar protection, over current and differential protection. Out of step protection, blinder design. Static relays, Numerical relay. Wide area protection.

ELL772 Planning and Operation of a Smart Grid

3 Credits (3-0-0)

Pre-requisite(s): ELL303

Smart grids key characteristics, demand side management, load characteristics, hybrid electric vehicles, energy markets, deregulation, wide area monitoring, protection and control, smart metering, adaptive relaying, power line carrier communication and networking, architectures and standards, renewable energy, distributed generation, smart grids policies.

ELL773 High Voltage DC Transmission

3 Credits (3-0-0)

General aspects and comparison with AC transmission system. Thyristor based HVDC Converter and inverter operation. Control of HVDC link. Interaction between AC and DC system. Harmonic generation and their elimination. Protections for HVDC system. Modeling of HVDC link for AC-DC power flow. AC-DC system power flow solution techniques. HVDC light.

ELL774 Flexible AC Transmission System

3 Credits (3-0-0)

The phenomenon of voltage collapse; the basic theory of line compensation. Static VAR compensators; static phase shifters; thyristors controlled series capacitors. Co-ordination of FACTS devices with HVDC links. The FACTS optimization problem. Transient and dynamic stability enhancement using FACTS components.

ELL775 Power System Dynamics

3 Credits (3-0-0)

Pre-requisite(s): ELL303

Dynamic models of synchronous machines, excitation system, turbines, governors, loads. Modelling of single-machine-infinite bus system. Mathematical modelling of multimachine system. Dynamic and transient stability analysis of single machine and multi-machine systems. Power system stabilizer design for multimachine systems. Dynamic equivalencing. Voltage stability Techniques for the improvement of stability. Direct method of transient stability analysis: Transient energy function approach.

ELL776 Advanced Power System Optimization

3 Credits (3-0-0)

Introduction to power system optimization problems and linkages. Optimization basics and solution techniques for convex and non convex optimization problems. Basic Optimal power flow. Preventive and corrective security constrained optimal power flow, Unit commitment, hydrothermal scheduling, generation, transmission and reactive expansion planning. Optimization with uncertain data Security states and optimization requirements. Convex and nonconvex optimization techniques. Static and dynamic optimization techniques. Day ahead and real time market planning. Optimization to handle uncertainty in data. Fuzzy and probabilistic techniques. Generation, transmission and reactive resources planning. Renewable generation integration optimization. Effect of markets and renewable generation in resources planning.

ELL777 Power System operation and control

3 Credits (3-0-0)

Control of active power. Turbine, governor and boiler modelling and control. Hydro and steam turbines, load frequency control, Automatic generation control in single-area and multi-area systems. Under-frequency load shedding, secondary frequency control. Automatic voltage regulators, excitation systems – modelling and control, small-signal stability studies, power system stabilizers, on-load tap-changing transformers.

ELL778 Dynamic Modelling And Control of Sustainable Energy Systems

3 Credits (3-0-0)

Microgrids and distributed generation; Introduction to renewable energy technologies; electrical systems and generators used in wind energy conversion systems, diesel generators, combined heat cycle plants, inverter based generation, solar PV based systems, fuel cell and aqua-electrolyzer, battery and flywheel based storage system; Voltage and frequency control in a microgrid; Grid connection interface issues.

ELL779 Forecasting Techniques for Power System

3 Credits (3-0-0)

Principles of forecasting load, wind and price. Statistical and non statistical based approaches. AI application for forecasting.

ELD780 Minor Project

2 Credits (0-0-4)

ELL780 Mathematical Foundations of Computer Technology

3 Credits (3-0-0)

Probability theory, stochastic processes, and statistical inference. Elements of real and complex analysis, and linear algebra. Optimization, with an emphasis on application and implementation.

ELP780 Software Lab

3 Credits (0-1-4)

Experiments related to the following topics: advanced data structures and algorithms, compilers, GUI, component-based software design, distributed and web based applications, UML, firmware, database applications.

ELV780 Special Module in Computers

1 Credit (1-0-0)

ELL781 Software Fundamentals for Computer Technology

3 Credits (3-0-0)

Introduction, data structures for combinatorial optimization: heaps, union-find, Fibonacci heaps, dynamic trees, dynamic graph structure; Asymptotic analysis; Divide & conquer and graph algorithms: Graph search: Breadth first, depth first, topological sorting, Fast Fourier Transform, Matrix Multiplication, Shortest path algorithms; Additional Data Structures: Suffix trees & string matching, Splay trees & amortized analysis; Advanced algorithmic design techniques: Dynamic programming (edit distance, chains of matrix multiplication, etc.), Network flow and its use for solving problems; Linear and integer programming, NP-completeness, Randomized algorithms (hashing & global minimum cut), Approximation Algorithms; Object oriented Software design, Design of Dependable Software.

ELP781 Digital Systems Lab

3 Credits (0-1-4)

ELV781 Special Modules in Information Processing-I

1 Credit (1-0-0)

Pre-requisite(s): to be decided by the instructor

ELL782 Computer Architecture

3 Credits (3-0-0)

Instruction set design, pipelining, memory hierarchy design, parallelism in various forms, warehouse scale computers, specific topics such as Vector, SIMD, GPU architectures, Embedded Systems, VLIW, EPIC, Multi-core architectures.

ELP782 Computer Networks Lab

3 Credits (0-1-4)

Simulation and hardware experiments on different aspects of

computer communication networks. Network traffic generation and analysis, differentiated service queues, network of queues using discrete event simulations.

ELL783 Operating Systems

4 Credits (3-0-2)

Processes and threads; CPU scheduling; concurrency, synchronisation; deadlocks; Memory management; files and I/O; Real-time operating systems; basics of Cloud computing.

ELL784 Introduction to Machine Learning

3 Credits (3-0-0)

Pre-requisite(s): MTL106

Overlaps with: ELL409, COL341, COL774

Introduction to Machine intelligence and learning; linear learning models; Artificial Neural Networks: Single Layer Networks, LTUs, Capacity of a Single Layer LTU, Nonlinear Dichotomies, Multilayer Networks, Growth networks, Backpropagation and some variants; Support Vector Machines: Origin, Formulation of the L1 norm SVM, Solution methods (SMO, etc.), L2 norm SVM, Regression, Variants of the SVM; Complexity: Origin, Notion of the VC dimension, Derivation for an LTU, PAC learning, bounds, VC dimension for SVMs, Learning low complexity machines - Structural Risk Minimisation; Unsupervised learning: PCA, KPCA; Clustering: Origin, Exposition with some selected methods; Feature Selection: Origin, Filter and Wrapper methods, State of the art - FCBF, Relief, etc; Semi-supervised learning: introduction; Assignments/Short project on these topics.

ELL785 Computer Communication Networks

3 Credits (3-0-0)

Pre-requisite(s): MTL106/ELL711

Overlaps with: CSL374, CSL672 (20%)

Theory/Lecture: Review of data communication techniques, basic networking concepts, layered network and protocol concepts, quality of service, motivations for cross-layer protocol design. Motivations for performance analysis, forward error correction and re-transmission performances, Markov and semi-Markov processes, Little's theorem, M/M/m/k, M/G/1 systems, priority queueing, network of queues, network traffic behavior. Concepts and analysis of multi-access protocols; contention-free and contention multi-access protocols. Basic graph theoretic concepts, routing algorithms and analysis.

Suggested lab Course content:

Laboratory: Simulation and hardware experiments on different aspects of computer communication networks. Network traffic generation and analysis, differentiated service queues, network of queues using discrete event simulations.

ELL786 Multimedia Systems

3 Credits (3-0-0)

Multimedia signal processing; coding and compression; standards: logic, issues, future directions; Multimedia issues governing developments in computer architecture and embedded systems, computer and communication networks, operating systems; Search and retrieval.

ELL787 Embedded Systems and Applications

3 Credits (3-0-0)

Introduction to embedded system. Architectural Issues: CISC, RISC, DSP Architectures.

Component Interfacing, Software for Embedded Systems : Program Design and Optimisation techniques, O.S for Embedded Systems, Real-time Issues. Designing Embedded Systems : Design Issues, Hardware- Software Co-design, Use of UML. Embedded Control Applications, Networked Embedded Systems : Distributed Embedded Architectures, Protocol Design issues, wireless network. Embedded Multimedia and Telecommunication Applications: Digital Camera, Digital TV, Set-top Box, Voice and Video telephony.

ELL788 Computational Perception and Cognition

3 Credits (3-0-0)

Introduction: Philosophical & Psychological models, Cognitive models & Bayesian Inferencing framework; Visual Perception of 3D space & scene; Perceptual processes for Object recognition & memorization; Auditory Perception; Haptic Perception; Attentional mechanism in multimedia perception; Applications: Image & video quality assessment, compression; Audio quality assessment, compression & indexing; Haptic interfaces; Cognitive Architecture; Computational Consciousness, Cognitive Robotics & Other applications.

ELL789 Intelligent Systems

3 Credits (3-0-0)

Overlaps with: COL333, COL671, COL770

Introduction, Search, Markov Decision Process, Game Playing, Constraint Satisfaction, Bayesian Network, Logic, Planning, Searching with non-deterministic action.

ELL790 Digital Hardware Design

3 Credits (3-0-0)

To provide advanced level exposure to digital hardware design and interfacing, elements of hardware software co-design, synthesis of digital systems at logic/RTL and system levels, simulation aspects of synthesis.

ELL791 Neural Systems and Learning Machines

3 Credits (3-0-2)

Overlaps with: MTL720

Introduction to biological neural systems, artificial neural network models, feed forward models, recurrent systems, analysis and applications.

ELL792 Computer Graphics

3 Credits (3-0-0)

Image formation: the mathematics, as well as photometry and colour; transformations; basic graphics primitives; texture mapping; image-based rendering.

JTD792 Minor Project

3 Credits (0-0-6)

ELL793 Computer Vision

3 Credits (3-0-0)

Pre-requisite(s): ELL715, ELL784

Overlaps with: COL780

Link between Computer Vision, Computer Graphics, Image Processing and related fields; feature extraction; camera models; multi-view geometry; applications of Computer Vision in day-to-day life.

ELL794 Human-Computer Interface

3 Credits (3-0-0)

This course will present some of the necessary background in neuroscience and computational methods necessary to begin work in this emerging field that is rapidly acquiring growing significance.

ELL795 Swarm Intelligence

3 Credits (3-0-0)

Swarm intelligence, distributed optimization, ant colony algorithms, PSO, firefly, bee, and related methods, applications and implementation issues.

ELL796 Signals and Systems in Biology

3 Credits (3-0-0)

Introduction to Cell Biology (DNA and Proteins); Introduction to Evolution; Modelling Evolution (Genetic Algorithms, Quasispecies); Genomic Signal Processing; Transcriptomic/Proteomic signals;

Regulatory networks and dynamics; Protein interaction networks; Signal transduction and metabolic networks; Evolvability and Learning. Project activities on these topics (involving the use of online biological databases and bioinformatics software tools); Student presentations and Journal Club.

ELL797 Energy-Efficient Computing

3 Credits (3-0-0)

Introduction and Motivation, Energy-Efficient Techniques in Operating Systems (Power Aware Scheduling, Adaptation for Multimedia Applications, Power aware memory and I/O device management, multiprocessor systems.), Storage, Compilers, Networks and Data Centers, Power management for Wearable devices and pervasive computing.

ELL798 Agent Technologies

3 Credits (3-0-0)

The course will comprise lectures on the various topics on agent technology and self-study on its applications in various domains. The topics are elaborated below. The material of the lectures will be gathered from text-books and recent research papers. The self-study will comprise study and analysis of typically 5-8 substantial research papers and will result in a term paper that will be evaluated.

ELL799 Natural Computing

3 Credits (3-0-0)

Pre-requisite(s): COL106, MTL106

Introduction to natural computing uncertainty handling: probability and fuzzy logic; evolutionary computing and problem solving as search; swarm intelligence ant colonies, swarm robotics; immunocomputing; introduction to DNA computing; basics of quantum computing.

JVD799 Minor Project

6 Credits (0-0-12)

ELD800 Minor Project (EEA)

3 Credits (0-0-6)

To be decided by the project supervisor.

ELL800 Numerical Linear Algebra and Optimization in Engineering

3 Credits (3-0-0)

Basics of Linear Algebra; Matrix decomposition - LU, LDU, QR and Cholesky factorization; Householder reflection, Givens rotation; Numerical implications of SVD; Numerical Solution for Linear Systems; Algorithm Stability; Problem Conditioning; Pivoting and scaling; Least Square Solutions; Numerical Matrix eigenvalue methods; Sparse Systems; Iterative methods for large systems; Krylov, Arnoldi, Lanczos methods; Numerical Optimization techniques - Conjugate gradient method, Linear and quadratic programming, Spectral and Pseudo-spectral methods.

ELP800 Control Systems Laboratory

1 Credit (0-0-2)

Basics of Sensors and Actuators, Study of AC and DC Motors, Linear Systems, Analog and Digital Motors, Synchros, Temperature Control.

ELD801 Major Project Part-I

6 Credits (0-0-12)

To be decided by the project supervisor.

ELL801 Nonlinear Control

3 Credits (3-0-0)

Overview of nonlinear control, Lyapunov stability for autonomous and non-autonomous systems, Input-Output Stability and Input-to-State Stability, Passivity analysis and applications, Absolute Stability, Incremental stability analysis, Lyapunov-based feedback control design, Feedback linearization and backstepping, Sliding mode control, Nonlinear observer design.

ELP801 Advanced Control Laboratory

2 Credits (0-0-4)

Magnetic Levitation System, Twin Rotor MIMO System, Gyroscope, Ball and Beam System, Embedded Control System, Mobile Robotic System.

JTD801 Major Project-I

6 Credits (0-0-12)

JVD811 Major Project-I

12 Credits (0-0-24)

JVS801 Independent Study

3 Credits (0-3-0)

ELD802 Major Project Part-II

12 Credits (0-0-24)

To be decided by the project supervisor.

ELL802 Adaptive and Learning Control

3 Credits (3-0-0)

Introduction to adaptive control, Review of Lyapunov stability theory, Direct and indirect adaptive control, Model reference adaptive control, Parameter convergence, persistence of excitation, Adaptive backstepping, Adaptive control of nonlinear systems, Composite adaptation, Neural Network-based control, Repetitive learning control, Reinforcement learning-based control, Predictive control, Robust adaptive control.

JVD812 Major Project-II

12 Credits (0-0-24)

ELL803 Model Reduction in Control

3 Credits (3-0-0)

Introduction to Model Reduction; Sources of Large Models - Circuits, Electromagnetic Systems, Mechanical Systems; Discretization Methods - Finite Difference Method (FDM), Finite Element Method (FEM); Classical Model Reduction Methods - Pade Approximation, Moment matching, Routh Approximants; Modern Methods - Modal Model Reduction Methods, SVD (Grammian) based methods, Krylov based methods, SVD-Krylov based methods; MOR for Nonlinear Systems - SVD & POD Methods; Model Reduction in Control; Control Design on Reduced Models - Sub-optimal control; Sliding Mode Control as model reducing control - First Order SM, Higher Order Sliding Mode.

ELL804 Robust Control

3 Credits (3-0-0)

Modeling of uncertain systems, Signals and Norms, Lyapunov theory for LTI systems

Passive systems - frequency domain, Passive systems - time domain, Robust Stability and performance, Stabilizing controllers - Coprime factorization, LQR, LQG problems

Ricatti equations and solutions, H-infinity control and mu-synthesis, Linear matrix inequalities for robust control, Ricatti equation solution through LMI.

ELL805 Networked and Multi-Agent Control Systems

3 Credits (3-0-0)

Overview of networked systems, Graph Theory Fundamentals, Graph-based Network Models, Network Optimization, Consensus Problem: cooperative control, leader-follower architecture.

Control under Communication Constraints, Formation Control, Swarming and Flocking Collision Avoidance, Game Theoretic Control of Multi-Agent Systems, Applications: Multi-robot/vehicle coordination, Sensor Networks, Social Networks, Smart Grids, Biological Networks.

ELL806 Scientific Visualization

3 Credits (3-0-0)

ELL806 Modeling and Control of Distributed Parameter Systems

3 Credits (3-0-0)

Overview: Motivation and examples (wave propagation, fluid flow, network traffic, electromagnetism), Modeling of Distributed Parameter Systems (DPS): Parabolic and Hyperbolic PDEs, Analytic and Numerical Solution of PDEs, Lyapunov stability of DPS Boundary control and Observer Design of DPS, Discretization of Distributed Parameter Models: Finite Difference, Finite Element and Boundary Elements, Reduction of FEM models, Applications: Control of systems with time delays, control of fluid flow, network control.

ELL807 Stochastic Control

3 Credits (3-0-0)

Overview of stochastic systems with examples, Modeling of Stochastic Systems: Continuous and discrete-time models subjected to noise, Markov Decision Processes, Introduction to Stochastic Calculus and Stochastic Differential Equations, Stochastic Stability, Stochastic Optimal Control with complete and partial observations, finite and infinite horizon problems, Linear and nonlinear Filtering, Separation Principle, Linear quadratic Gaussian Problem, Stochastic Dynamic Programming, Stochastic Adaptive Control, Applications: Finance, operations research, biology.

ELL808 Advanced Topics in Systems and Control

3 Credits (3-0-0)

To be decided by the Instructor when floating this course: Can be anything that is related to systems and control engineering but is not covered in any of the established courses.

ELD810 Minor Project (Communication Engineering)

3 Credits (0-0-6)

ELL810 Cyber Security and Information Assurance

3 Credits (3-0-0)

Introduction to cyber security, information assurance, computer security and the associated threat, attack, adversary models, identity representation, management and access control, intrusion detection, security at different levels: network, system, user, program security, network security, wireless security, mobile security, hardware security and the security of cyber physical systems.

ELD811 Major Project Part-I (Communication Engineering)

6 Credits (0-0-12)

ELD812 Major Project Part-II

12 Credits (0-0-24)

ELL812 Microwave Propagation and Systems

3 Credits (3-0-0)

Frequency bands and allocations. Earth and its effects on propagation. Atmosphere and its effects on propagation. Attenuation of millimeter waves. Line-of-sight communication links: system configuration, multiplexing, link design. Troposcatter propagation and links: Fading and diversity reception, path profile and path loss, link design, signal design for fading channels.

ELL813 Advanced Information Theory

3 Credits (3-0-0)

Capacity of single-user Gaussian multi-antenna deterministic channels and optimal strategies. Reliable transmission in single user state dependent channels. Capacity of Gaussian single-antenna fading channels with state (RX CSI, Full CSI). Capacity of single-antenna frequency-selective fading channels (OFDM modulation, waterfilling across frequency). Capacity of Gaussian multi-antenna single user fading channels (RX CSI only, Full CSI). Spatial multiplexing gain, array

gain. Transmitter and receiver architectures, V-BLAST transmission, Zero-Forcing receiver, MMSE receiver, MMSE SIC receiver. Optimality of MMSE-SIC. Capacity region of the multi-user Gaussian MAC channel. Capacity region of the multiuser Gaussian Broadcast channel (BC) with single-antenna terminals. Capacity of state dependent channels with non-causal side information (Gelfand-Pinsker coding). Dirty paper coding to pre-cancel known interference. MAC-BC duality. Capacity region of the multi-user Gaussian Broadcast channel with multi-antenna terminals (Dirty paper coding achieves the capacity region). Capacity region of the Interference channel. There are no laboratory or design activities involved in this course.

ELL814 Wireless Optical Communications

3 Credits (3-0-0)

General introduction, optical channel modeling, background noise calculations, Modulation techniques: M-PPM, OOK, mxn PAM, subcarrier modulation, DPPM, DHPIM, DAPPM, psd and bandwidth requirement evaluation, Detection techniques - Photon counter, PMT, coherent techniques, bit error rate evaluation in presence of atmospheric turbulence, concept of adaptive threshold, effect of turbulence and weather conditions viz., drizzle, haze fog on error performance and channel capacity, link availability.

ELL815 MIMO Wireless Communications

3 Credits (3-0-0)

Introduction to space-time diversity, MIMO channel, MIMO information theory, error probability analysis, transmit diversity and space-time coding, linear STBC design, differential coding for MIMO, precoding, multiuser MIMO; There are no laboratory or design activities involved with this course.

ELL816 Satellite Communication

3 Credits (3-0-0)

Introduction to satellite communication and orbital theory, satellite antennas, satellite link design, channel models for satellite links, modulation, multiple access techniques for satellite communication, VSAT, introduction to MIMO systems and error analysis, multiple antenna based satellite communication, hybrid satellite-terrestrial communication system.

There are no laboratory or design activities involved with this course.

ELL817 Access Networks

3 Credits (3-0-0)

Contents: Types of access networks, wired (copper and optical) and wireless access networks, management, dimensioning and scaling of access networks, access network design.

ELL818 Telecommunication Technologies

3 Credits (3-0-0)

Types of Data Networks, types of access and edge networks, core networks, OSS/NMS and Telecom Management network (TMN), Teletraffic Theory and Network analysis.

ELL819 Introduction to Plasmonics

3 Credits (3-0-0)

EM Waves, Maxwell's Equations, Origin of Permittivity, Evanescent Waves, Surface Plasmons, Scattering and Diffraction, Spoof Surface Plasmon, Extraordinary Optical Transmission, Numerical Simulations of Surface Plasmons, Negative Index Materials.

ELL820 Photonic Switching and Networking

3 Credits (3-0-0)

Study of different types of networks, the enabling technologies and devices. Broadcast and Select network. Single and Multi-hop networks with example of Access networks, PONS etc., Wavelength Routing network, virtual topology, Metro and Wide area networks. Wavelength Routing and Assignment, Traffic Grooming and Protection, Network Control and Management, Optical packet and burst switching, Network Simulation Tools and Design guidelines.

ELL821 Selected Topics in Communication Systems and Networking-I

3 Credits (3-0-0)

ELP821 Advanced Telecommunication Networks Laboratory

3 Credits (0-1-4)

To provide advanced level laboratory experiments in telecom signaling and transmission.

ELV821 Special Module in Communication Systems and Networking-II

1 Credit (1-0-0)

ELL822 Selected Topics in Communication Systems and Networking-II

3 Credits (3-0-0)

ELP822 Network Software Laboratory

3 Credits (0-1-4)

Contents: CASE tools, client-server programming, middleware – and use of Object Request Broker architectures, use of network emulators, using networks APIs Parlay/JAIN, service-oriented architectures, openflow and SDN, network management software design.

ELL823 Selected Topics in Information Processing-I

3 Credits (3-0-0)

ELV823 Special Modules in Information Processing-II

1 Credit (1-0-0)

ELL824 Selected Topics in Information Processing-II

3 Credits (3-0-0)

ELD830 Minor Project

3 Credits (0-0-6)

ELL830 Issues in Deep Submicron VLSI Design

3 Credits (3-0-0)

VLSI Scaling rules and their impact: Short channel effect, Sub threshold leakage current, Gate leakage, VTH and body bias; Low power design: Technology level: 3D and 4 terminal MOSFETs, PDSOI, FDSOI, FINFET; Sub threshold leakage control: Transistor stacking in digital logic Multiple VTH, VDD designs, Dynamically adjustable VTH; Digital Circuit Design: Digital Sub-threshold Logic, Noise Immunity, Clock gating, Switching activity minimization; Analog Circuit Design: gm/ID Methodology for Design, Low power, low voltage opamp design, Subthreshold operation of opamps; Architecture level: Array Based Architectures, Parallel and Pipelined Architectures; Interconnects & Noise: Capacitive & Inductive coupling Analysis & Optimization, Power/Ground Noise, $L \cdot di/dt$ noise, Power/Ground Placement Optimization, Decoupling.

ELP830 Semiconductor Processing Laboratory

3 Credits (0-0-6)

Deposition of Semiconductor Materials and Metals: Sputter Deposition, E-Beam Deposition, and Thermal Evaporation; Photolithography; Electron-Beam Lithography; Epitaxial Growth of Semiconductors, Materials Characterization.

ELV830 Special Module in Low Power IC Design

1 Credit (1-0-0)

Special Module that focuses on special topics, development and Research problems of importance in the area of Low Power IC Design.

ELD831 Major Project Part-I (Integrated Electronic Circuits)

6 Credits (0-0-12)

ELL831 CAD for VLSI, MEMS, and Nanoassembly

3 Credits (3-0-0)

Algorithms for design, modelling, and simulation ranging from VLSI, MEMS, to nanoassembly; computer aided nano-design for materials.

ELP831 IEC Laboratory-I

3 Credits (0-0-6)

Introduction to Cadence, Learning Cadence design framework and Virtuoso environment, Design with Virtuoso schematic editor, Layouts, Learning and applying Synopsys and Xilinx tools, Circuit simulation and SPICE.

ELV831 Special Module in VLSI Testing

1 Credit (1-0-0)

Special Module that focuses on special topics, development and Research problems of importance in the area of VLSI Testing.

ELD832 Major Project Part-II

12 Credits (0-0-24)

ELL832 Selected Topics in IEC-I

3 Credits (3-0-0)

ELP832 IEC Laboratory-II

3 Credits (0-0-6)

Introduction to Cadence, Learning Cadence design framework and Virtuoso environment, Design with Virtuoso schematic editor, Layouts, Learning and applying Synopsys and Xilinx tools, Circuit simulation and SPICE.

ELV832 Special Module in Machine Learning

1 Credit (1-0-0)

Special Module that focuses on special topics, development and Research problems of importance in this area.

ELL833 CMOS RF IC Design

3 Credits (3-0-0)

Historical Aspects – From Maxwell to Current Wireless standards; The bridge between communication system designer and RF IC Designer: a) Comm. system characterization, b) RF System Characterization; Transceiver Architectures – Motivation for the individual blocks; Lumped, passive RLC, RF properties of MOS, Tuned Amplifiers; LNAs: Noise sources, Cascades and LNA Design; Mixers – passive and active mixers; Oscillators: Analysis Fundamentals, Inductors, LC Oscillators and VCOs; Frequency synthesizers: Principles, Integer N vs Fractional PLL, Design Concepts.

ELP833 Device and Materials Characterization Laboratory

3 Credits (0-0-6)

Skill development in semiconductor modeling and characterization through hands on electrical characterization experiments. This includes wafer-level DC and RF characterization of p-n junction diode, MOS capacitor and transistor, photo-electric characterization of solar cells, TCAD and compact modeling of these devices, Materials Characterization (SEM, AFM, TEM, etc.).

ELV833 Special Module in Semiconductor Business Management

1 Credit (1-0-0)

To educate students about semiconductor business. This includes

business domains in semiconductors, latest business challenges, market trends and forecasts, business planning and incubation, execution and delivery, technical and financial analysis of R&D, business and finance models of chip manufacturing units (or fabs.), foundries, and solar power plants.

ELL834 Selected Topics in IEC-II

3 Credits (3-0-0)

ELV834 Special Module in Nanoelectronics

1 Credit (1-0-0)

Special Module that focuses on special topics, development and Research problems of importance in the area of Nano Electronics.

ELD850 Minor Project

3 Credits (0-0-6)

ELL850 Digital Control of Power Electronics and Drive Systems

3 Credits (3-0-0)

Review of Digital signal processors, Laplace transforms, Theory of sampling, z-transformations, sampling techniques, Digital PWM generation schemes, Realization of different PWM's using DSP's, Control of DC-DC Converters, Inverters, DC and Ac Machines.

ELP850 Electrical Machines Laboratory

1.5 Credits (0-0-3)

Experiments on Electrical Machines and their control.

ELT850 Industrial Training and Seminar

3 Credits (0-0-6)

ELD851 Major Project Part-I

6 Credits (0-0-12)

ELL851 Computer Aided Design of Electrical Machines

3 Credits (3-0-0)

Introduction of Standards and standardizations, specifications, frame size, basic design methodology and engineering considerations. Properties of electric, magnetic and insulating materials. Choice of materials, frames etc. Computerization of design procedures. Optimization techniques and their application to design problems. Design of large and H.P. motors. Database and knowledge based expert systems. Development of PC based software.

ELP851 Power Electronics Laboratory

1.5 Credits (0-0-3)

Experiments on Power electronic converters and their control.

ELD852 Major Project Part-II

12 Credits (0-0-24)

ELL852 Condition Monitoring of Electrical Machines

3 Credits (3-0-0)

The course includes the need for condition monitoring. Three main subdivisions of the course are types of fault and their symptoms, diagnostic methods to identify these faults and a deep signal processing analysis for fault diagnosis. The various components prone to fault are stator, rotor, shaft, gear box, bearing etc. The diagnosis methods includes diagnosis based on temperature, infrared signal, vibration, noise, motor current signature analysis etc. various signal processing techniques such as fuzzy logic, neural network from fault diagnosis point of view are also included in this course.

ELP852 Electrical Drives Laboratory

1.5 Credits (0-0-3)

Experiments on drive systems with converter fed dc and ac drives and their control.

ELL853 Advanced Topics in Electrical Machines*3 Credits (3-0-0)*

Introduction to Advanced Topics in Electrical Machines, Synchronous Reluctance Machines, Hybrid Motors, Linear Motors, Super conducting Machines, PCB Motors, Micro motors, Wound Pole Machines. Applications of all these advanced motors in field of Robotics, Automation, Electric Vehicles, pumping etc. The rating consideration and special advantages with these motors in various practical or field conditions is primary objective of this course. Other Advanced machines, Case Studies, Computer Aided Simulation of Electrical Machines are added for enhanced understanding of the topic.

ELP853 DSP Based Control of Power Electronics and Drives Laboratory*1.5 Credits (0-0-3)*

Experiments on the DSP/Digital signal controllers, Interfacing peripherals to DSP, Assembly language programming, Real-time voltage/ current, speed sensing signal and processing, PWM strategies realization through DSP and controlling power electronic and Drive Systems.

ELL854 Selected Topics in Electrical Machines*3 Credits (3-0-0)*

Recent developments in the area of electrical machines.

ELP854 Electrical Machines CAD Laboratory*3 Credits (0-1-4)*

Computer aided design of electrical machines.

ELL855 High Power Converters*3 Credits (3-0-0)*

Introduction to High Power devices – IGBT, Thyristor, IGCT. Different topologies of high power converters – Voltage Source and current source converter, 2- level converters, 3 level NPC converter, Cascaded H-Bridge Multilevel Converters, Modular multilevel converters. Pulse width modulation techniques for high power converters – Level shifted PWM, Phase shifted PWM, Space vector PWM for multilevel converters. Design of high power converter components, operational issues, fault tolerant operation, reliability, mechanical design. Design of filters for high power converters. Relevant IEEE and IEC standards for high power converters.

ELP855 Smart-Grids Laboratory*3 Credits (0-1-4)*

Experiments related to smart-grids measurement and control.

ELL856 Advanced Topics in Power Electronics*3 Credits (3-0-0)*

Upcoming power electronic devices- SiC and GaN devices. Design of power electronic converters, Introduction to soft-switching in dc-dc and dc-ac applications.

ELL857 Selected Topics in Power Electronics*3 Credits (3-0-0)*

Recent developments in power electronics.

ELL858 Advanced Topics in Electric Drives*3 Credits (3-0-0)*

Advanced PWM Techniques. Control of switched reluctance motor drives. Control of slip-ring induction motor drives. Self-commissioning and self-adaptation techniques in drives. Sensor-less techniques in drives. Fault tolerant controllers and converters. Other recent topics on drives.

ELL859 Selected Topics in Electric Drives*3 Credits (3-0-0)*

Recent developments in the area of electric drives.

ELD870 Minor Project-I*3 Credits (0-0-6)*

To be decided by the project supervisor

ELL870 Restructured Power System*3 Credits (3-0-0)*

Philosophy of market models, Concepts in micro-economics, Centralized and de-centralized Dispatch Philosophies, Congestion Management, Ancillary Service Management, Transmission Pricing Methods, Loss Allocation Algorithms, Locational Marginal Price (LMP) calculation and properties, Financial Transmission Rights (FTRs), Transmission Expansion Planning, Market Power, Working of International Power Markets, Restructuring Issues in Indian Power Sector.

ELP870 Power System Lab-I*3 Credits (0-1-4)*

Power flow studies, fault studies, state estimation, security analysis, robust power flow methods, power flow with uncertain data.

ELD871 Major Project Part-I*6 Credits (0-0-12)*

To be decided by the project supervisor.

ELL871 Distribution System Operation and planning*3 Credits (3-0-0)*

Structure of distribution system, modeling of system components, power flow, fault studies, state estimation, optimal power flow, optimal feeder reconfiguration, optimum resources planning, incorporation of DGs in operation and planning.

ELP871 Power System Lab-II*3 Credits (0-1-4)***ELD872 Major Project Part-II***12 Credits (0-0-24)*

To be decided by the project supervisor.

ELL872 Selected Topics in Power System*3 Credits (3-0-0)*

To be decided by the Instructor when floating this course: It can be anything that is related to power system, but is not covered in any of the established courses.

ELL873 Power System Transient*3 Credits (3-0-0)*

Origin and nature of transients and surges. Lumped and distributed circuit representations. Line energisation and de-energisation transients, current chopping, short-line faults, trapped charge effects, effect of source, control of transients, Lightning, effect of tower footing resistance, travelling waves, insulation coordination, circuit breakers duty, surge arresters, overvoltage limiting devices.

ELL874 Power System Reliability*3 Credits (3-0-0)*

Review of basic probability theory, reliability theory, network modeling and evaluation of simple and complex systems, generation system reliability – concept of loss of load probability, energy not served, transmission system reliability, component failure, distribution system reliability with perfect and imperfect switching.

ELD880 Major Project Part-I*6 Credits (0-0-12)***ELL880 Special Topics in Computers-I***3 Credits (3-0-0)*

ELS880 Independent Study

3 Credits (3-0-0)

ELD881 Major Project Part-II

12 Credits (0-0-24)

ELL881 Special Topics in Computers-II

3 Credits (3-0-0)

ELL882 Large-Scale Machine Learning

3 Credits (3-0-0)

Introduction, Randomized Algorithms, Matrix Approximations (low-rank approximation, decomposition, sparse matrices, matrix completion), Large Scale Optimization, Kernel Methods (fast training), Boosted Decision trees, Dimensionality Reduction (linear and nonlinear methods), Distributed Gibbs Sampling, Sparse Methods/ Streaming (sparse coding...); Applications.

ELL883 Embedded Intelligence

3 Credits (3-0-0)

Basics of embedded, learning, and adaptive systems; sensors, nature of dynamic environments, hardware aspects.

ELL884 Information Retrieval

3 Credits (3-0-0)

Motivation, evaluation, classical IR models, Indexing, ML techniques, Semantic search, MIR, Web-scale information retrieval, Query processing, User interfaces.

ELL885 Machine Learning for Computational Finance

3 Credits (3-0-0)

Time series forecasting techniques, Introduction to Portfolio theory, Trading Systems, Optimisation methods, Risk Management, Machine Learning for Algorithmic Trading.

ELL886 Big Data Systems

3 Credits (3-0-0)

Introduction; Hadoop, Map-Reduce, GFS/HDFS, Bigtable/HBASE; Extension of Map-Reduce: iMap-reduce (iterative), incremental map-reduce. SQL and Data-parallel programming, Dryad/LINQ. Data-flow parallelism vs. message passing. Data locality. Memory hierarchies. Sequential versus random access to secondary storage. NoSQL systems. NewSQL systems. Finding similar items and LSH; Search Technology: link analysis and Page-rank algorithm; Large Scale Graph Processing; Mining Streaming Data and Realtime analytics: Window semantics and window joins. Sampling and approximating aggregates (no joins). Querying histograms. Maintaining histograms of streams. Use of Haar wavelets. Incremental and online query processing: online aggregation.

ELL887 Cloud Computing

3 Credits (3-0-0)

Introduction; Example System: Apple iCloud, Amazon-AWS; Fundamental Concepts: Cloud Characteristics, Cloud delivery models; Cloud Enabling Technology: broad-band network, virtualisation technology; Cloud Infrastructure Mechanisms: Logical Network Perimeter, Virtual Server, Cloud Storage Devices; Cloud Architecture: Workload Distribution Architecture, Resource Pooling Architecture, Dynamic Scalability Architecture, Hypervisor Clustering Architecture, Load Balanced Virtual Server Instances Architecture, Elastic Resource Capacity Architecture, Elastic Disk Provisioning Architecture, Redundant Storage Architecture; Cloud Security: Encryption, Identity and Access management, Cloud-based Security Groups; Working with Cloud: Building Service Platforms, Cost Metrics, Pricing Models.

ELL888 Advanced Machine Learning

3 Credits (3-0-0)

Advanced topics in machine learning, including Nonlinear Dimension Reduction, Maximum Entropy, Exponential Family Models, Graphical Models; Computational Learning Theory, Structured Support Vector Machines, Feature Selection, Kernel Selection, Meta-Learning, Multi-Task Learning, Semi-Supervised Learning, Reinforcement Learning, Approximate Inference, Clustering, and Boosting.

ELL889 Protocol Engineering

3 Credits (3-0-0)

Principles, stages, specification formalisms (UML, SDL, ASN.1) of telecom protocol design, protocol software development process, computer aided protocol engineering, verification and testing of protocols, object oriented techniques in protocol development, kernel level development and programming of protocols.

ELL890 Computational Neuroscience

3 Credits (3-0-0)

Fundamentals of brain anatomy and physiology, signals of brain, Brain signal recording and imaging techniques, Human experimentation study design, Processing the X-D neural data, Machine learning approaches, Graph theory and neural networks, Multivariate pattern analysis in 4D Imaging data, Statistical inferences, student projects and presentations.

ELL891 Computational Linguistics

3 Credits (3-0-0)

Introduction to language and linguistics; Mathematical foundations: statistics and machine learning; Introduction to corpus-based computational linguistics; Lexical analysis; Syntactic analysis; Semantic analysis; Discourse analysis; Psycholinguistics, computational cognitive models of language processing and evolution; Assignments and practical exercises involving the application of these techniques to real-word corpora.

ELL892 Internet Technologies

3 Credits (3-0-0)

Web and service oriented architectures, dynamic web site programming (client side and server side), web application development, web based repositories, UI design, XML, Web 2.0 and the semantic web, applications.

ELL893 Cyber-Physical Systems

3 Credits (3-0-0)

Introduction: core principles behind CPSs; Specification of CPS, CPS models: Continuous, Discrete, Hybrid, Compositional; Abstraction and System Architecture, Design by Invariants, Sensing and Fusion, Cloud of Robots/CPS; Case Studies: Healthcare, Smart Grid, Transportation.

ELL894 Network Performance Modeling and Analysis

3 Credits (3-0-0)

Network performance models and classifications, Hidden Markov Models (HMM), Delay and throughput analysis using Markov models, Performance analysis with multi-class traffic, Renewal theory and regenerative processes, Performance analysis with semi-Markov traffic characteristics, Network performance analysis with interactive servers, Practical network traffic characterization, Network performance stability, Introduction to dynamic programming, Example network modeling scenarios in various engineering applications.

ELD895 MS Research Project

36 Credits (0-0-72)

ELL895 Network Security

3 Credits (3-0-0)

Introduction to cryptography, public key distribution and user

authentication, TLS and wireless network security, secure email and PGP, IP security, system security - intrusion, malicious software and firewalls.

ELL896 Mobile Computing

3 Credits (3-0-0)

Overview of mobile computing; introduction to GSM, 3GPP, 4G LTE, LTE-A standards; wireless networking protocols: mobile IP, ad hoc networks, wireless TCP; cognitive radio networks; data broadcasting; location and context awareness; QoS, QoE; disconnected or weakly connected operations; protocol and resource optimization; wireless security issues.

ELL897 Network Management

3 Credits (3-0-0)

Activities, methods, operational procedures, tools, communications interfaces, protocols, and human resources that pertain to the operation, administration, maintenance, and provisioning of communications networks, network management standards, technologies; functional areas of fault management, configuration

management, accounting management, performance management, and security management, major Internet and telecommunications standards for network management: SNMPv3, RMON, CMIP and TMN.

ELL898 Pervasive Computing

3 Credits (3-0-0)

Introduction, computer and network architectures for pervasive computing, mobile computing mechanisms, human-computer interaction using speech and vision, pervasive software systems, location mechanisms, practical techniques for security and user-authentication, and experimental pervasive computing systems.

ELL899 Testing and Fault Tolerance

3 Credits (3-0-0)

Introduction to testing, simulation, fault simulation, automatic test pattern generator, sequential logic tests, automatic test equipment, design for testability, Built-In-Self-Test (BIST), behavioral test and verification.

Department of Energy Science and Engineering

ESL100 Energy Resources and Utilization

4 Credits (3-1-0)

Overlaps with: Some overlap with ESL380, ESL714, ESL734, ESL875, PHY302

Conventional and non-conventional energy resources and their potential, Introduction of conventional fuels (Coal, oil, natural gas), Fuels (solid, liquid, gas): characterization (Ultimate, Proximate analysis, etc.), gasification, combustion, utilization of conventional fuels in combustion engines (Steam, Gas turbines, IC engines) and fuel cell, Nuclear energy: fuel resources, nuclear reactor, and their environmental impact; Renewable energy (Solar, wind, biomass, hydro energy, geothermal, OTEC, tidal, etc.), resource assessment and their potential, biomass characterization, utilization of renewable energy and bioenergy for heat and power generation, and environmental impact.

ESL200 Fundamentals of Energy Engineering

5 Credits (3-1-2)

Overlaps with: Some overlap with ESL340, ESL360, ESL740, ESL753, ESL755, ESL768

Introduction to various energy resources and technology development. Energy consumption pattern in different sectors (Industries, commercial and residential buildings, agriculture, service industries, etc.), Power generation using steam turbine power plant, gas turbine power plant, internal combustion engines and fuel cell and associated limitations, challenges and environmental effects. Various unconventional and renewable energy sources and technologies such as nuclear power plants, solar power plants (Photovoltaic and Thermal), hydro power plant, wind power plant, bioenergy and power generation, wave and tidal power, etc. Fundamental and applied concepts of energy for strengthening of sustainable energy and environment, thermal and electrical utilities, energy flow and Sankey diagram, measures of energy efficiency improvements, demand and supply analysis, life cycle assessment, and emerging issues in the built environment.

ESL220 Semiconductors for Energy System

3 Credits (3-0-0)

Overlaps with: Some overlap with PYL102, PYL306, PYL312, PYL125

Classical and quantum statistics, Fundamentals of semiconducting materials, Doping and pn-junction formation, Optical absorption processes in semiconductors, Understanding of carrier depletion region, Minority- and the majority- charge carriers, Drift and diffusion of charge carriers, Construction of metal-semiconductor and semiconductor-semiconductor energy-band diagrams. Ohmic and Schottky barriers for charge carriers, Current-voltage characteristics under the voltage-bias and light-bias conditions, PN-junction breakdown mechanisms. Homo- and Hetero-junctions, Basic charge carrier transport equations for semiconductor device operation. Capacitance-voltage and Impedance analysis of semiconductor devices. Optoelectronic Devices: Solar cells, Photodiode, Light emitting diodes.

ESL260 Network Analysis

3 Credits (2-1-0)

Overlaps with: Some overlap with ELL202

Pre-requisite(s): ELL101

Circuits, types, properties and models. Circuit modeling methods. Steady state / transition processes and equivalent models of circuit elements. Types of circuit responses. Time-domain response: calculating step and impulse responses of circuits containing resistors, inductors and capacitors. Time-domain analysis of first (RC and RL) and second order (RLC) circuits. Resonance in RLC circuits. Inductive (magnetic) coupling. Mutual inductance. Series and parallel resonant RLC circuits. Two magnetically coupled RLC circuits. Computation of circuit response to arbitrary input signals – convolution. Convolution properties. The forward and inverse Laplace transforms. S-domain circuit analysis. Study subject structure Two-port networks:

impedance and admittance matrices, two-port network connections, reciprocity and symmetry.

ESP260 Electrical Energy Laboratory

1.5 Credits (0-0-3)

Overlaps with: Some overlap with ESP713, ESP705

Characteristics of different electrical machines, Power system protection, Power system transmission and distribution, Basics of closed loop control, Power electronic converters and their applications.

ESL261 Analog and Digital Electronics

3 Credits (3-0-0)

Overlaps with: Some overlap with ELL201, ELL304

Pre-requisite(s): ELL100

Working of BJT and MOSFET, biasing schemes, single stage amplifier, frequency compensation, current mirrors, multistage amplifiers; differential and operational amplifiers, negative and positive feedback, applications of operational amplifiers (integrator, differentiator, adder, subtractor, power amplifier, zero-crossing detectors, filter circuits, oscillators), Logic Gates, Number systems, arithmetic operations, K-maps, multiplexers, demultiplexers, decoders, ROMs, latches, flip-flops, registers, counters, asynchronous, synchronous counters, memories, switch level implementation of logic families.

ESL262 Electrical Machines

3 Credits (3-0-0)

Overlaps with: Some overlap with ELL401, ELL756

Pre-requisite(s): ELL100, ESL260

Working of different machines including single phase and three phase transformers, DC generators, DC motors, single phase and three phase induction machines, synchronous machines, Permanent Magnet Machines, Linear Induction Machine (LIM), Brushless DC Machine, Switched Reluctance Machine, Stepper motors and other small machines. The course also provides in-depth knowledge and understanding of various machine characteristics, different control techniques, various tests associated with them.

ESL263 Power Electronics and Drives for Energy Engineering

3 Credits (3-0-0)

Overlaps with: Some overlap with ELL231, ELL302, ELL332

Pre-requisite(s): ELL100, ESL260

Basics of power electronics, different types of converters, various factors for selecting Power Electronic devices for different applications, various Types of Fully Controlled switches, analysis and applications of rectifiers and inverters, analysis of DC-DC converters, control and modulation techniques, Overview of various types of electrical drives, types of loads, DC drives. Mathematical modeling and analysis of steady state characteristics as well as choice and dimensioning of current- and speed-controllers, most commonly used AC drives; Induction motor drives, Permanent magnet synchronous motor drives and synchronous motor drives, Converter topologies and control principles used in modern electrical drives, power electronics applications to special machines.

ESL280 Introduction to Plasma Concepts

4 Credits (3-0-2)

Overlaps with: Some overlap with ESL744, ESL870, ESL871, PYL305

Plasma in Daily Life, Plasma concepts: Introduction, Debye Screening, Plasma oscillation, Plasma particle phenomena, Equivalent Circuit Model, Concept of plasma potentials and its importance in design of plasma sources, Pre-sheath, Plasma sheath-Wall interaction, low pressure and atmospheric pressure plasmas, thermal and non-thermal plasmas with examples, Different Types of Plasma Sources (DC / RF / microwave / ECR / helicon / surface wave), Plasma as Fluids, Wave Propagation in Plasmas, Basic Plasma diagnostics,

Plasma Fusion Energy, Plasma in space propulsion, Plasma based materials processing, Plasmas for waste management, Plasma for Environment, Plasma medicine.

ESL300 Self-Organizing Dynamical Systems

3 Credits (3-0-0)

Pre-requisite(s): EC60 (for UG students)

Dynamical systems dissipative and area preserving, Patterns in Hamiltonian dynamics invariants and symmetry, KAM theorem / coherent structures, complexity and pattern formation, Belousov – Zhabutinsky reaction, Landau-Ginzburg / mean-field models, scaling fractals, Cellular automata, Wavelet transforms, Phase transitions and order parameter, Criticality the border of order and chaos, Entropy and direction of time, Negentropic systems, Self-organized criticality, lattice models, Examples: Electrical circuits, Management systems, Astrophysical systems, Plasma and magnetic surface systems, Biological systems, Non-linear systems.

ESP300 Energy Innovation Laboratory

1.5 Credits (0-0-3)

Pre-requisite(s): ESP260, ESL280

Students will be doing innovative projects relevant to energy engineering based on their interest. Based on the Student interest, they will be assigned to perform energy related design projects/experiments.

ESL320 Building Integrated Photovoltaics

3 Credits (3-0-0)

Overlaps with: Some overlap with ESL360, ESL755, ESL852

Introduction to PV technology, Building envelope as a support for PV, PV issues for building designers, Location constraints, Effect of tilt and orientation, Design guidelines for the integration of PV modules for Shading systems, Rainscreen systems, Stick system curtain walls, Unitised curtain wall, Double-skin facades, Atria and canopies, PV integration opportunities, Specific issues of BIPV in the residential sector and refurbishment applications, Apartment blocks, Low-rise traditional houses, PV maintenance, Various case studies.

ESL330 Energy, Ecology & Environment

4 Credits (3-1-0)

Overlaps with: Some overlap with ESL710

Pre-requisite(s): EC60 (for UG students)

Concepts of ecosystems and environment, Characteristics and types of ecosystems, Autecology and synecology, Energy flow in ecosystems, Feedback loops, Trophic webs, Eco-technology and Eco-development, Energy-environment interaction, Impact of energy sources (coal, oil, natural gas, solar, wind, biomass, hydro, geothermal, tidal, wave, ocean thermal and nuclear) on environment, local regional and global implications, Approaches to mitigate environmental emissions from energy sector, Global initiatives Kyoto Protocol, Clean development mechanism, Case studies.

ESL331 Hydrodynamic Machines

4 Credits (3-1-0)

Overlaps with: Some overlap with ESL768, CVL482

Pre-requisite(s): APL106

Basic fluid mechanics of turbo-machinery, momentum and the head-momentum equations, Classification of Hydrodynamic machines, Theory of turbo machinery, Euler's theorem, Velocity and pressure diagram, Head, Power, Efficiency Dimensional analysis and similarity, Specific-speed, Hill curves; Pelton Turbine: working principle, velocity triangles, nozzle and flow regulating mechanism, jet deflector, braking, power and efficiency; Francis and Kaplan Turbines, working principles, degree of reaction, velocity triangles, power and efficiency, regulation; draft tube; Performance characteristics of turbines; Hydro-kinematic turbines, Pump as turbine; Centrifugal and axial flow pumps, head-flow rate, specific speed, power, efficiency, operating point for different pump systems, cavitation in pumps and turbines; Hydrodynamic transmissions.

ESL340 Non-Conventional Source of Energy

4 Credits (3-0-2)

Overlaps with: Some overlap with ESL740

Pre-requisite(s): EC60 (for UG students)

Global & National energy scenarios, Forms & characteristics of renewable energy sources, Solar radiation, Flat plate collectors, Solar concentrators, Thermal Applications of solar energy, Photovoltaics technology and applications, Energy storage, Energy from biomass, Thermochemical, Biochemical conversion to fuels, biogas and its applications, Wind characteristics, Resource assessment, Horizontal & vertical axis wind turbines, Electricity generation and water pumping, Micro/Mini hydropower systems, Water pumping and conversion to electricity, Hydraulic ram pump, Ocean Thermal Energy Conversion (OTEC), Geothermal, Tidal and Wave energies, Material aspects of Renewable energy technologies and systems.

ESL341 Energy Storage

3 Credits (3-0-0)

Overlaps with: Some overlap with ESL772, ESL773, ESL880

Sensible thermal energy storage, Latent energy storage, Thermal management system design using Latent thermal energy storage, Thermochemical heat storage system, Hydrogen energy and chemical energy storage and production, Battery electrical energy storage systems, Pumped storage systems, Other electrical energy storage systems, Compressed air storage, Flywheels, Superconducting Magnetic energy storage, Integration of energy storage systems, energy storage system optimization.

ESL342 Nanotechnology in Energy Conversion and Storage

3 Credits (3-0-0)

Overlaps with: Some overlap with PYL705, CRL725, CLL723

Introduction to nanotechnology, various nanostructures Quantum dots, nanocrystalline thin films and nano-particles, Semiconductor nanostructure based electronic and optical properties, fabrication methodology (Arc discharge, RF-plasma, Plasma arc technique, Ion sputtering, Laser ablation, Laser pyrolysis, Ball Milling, Molecular beam epitaxy, Chemical vapour deposition method and Electro deposition), nanolithography, characterization techniques technologies for direct energy conversion, nanostructures (quantum dots, nano tubes, nano rods) for Anti reflection, plasmonics and light scattering) in p-n junction and Excitonic solar cells, Nanomaterials for Solar Thermal Energy, Nanomaterials in Energy Storage Devices. Thermal Transport in Solid Micro/Nanostructures, Size Effects, Quantum Conductance, Tunneling, Non-equilibrium Heat Conduction, and Nanoscale Thermal Radiation and Radiative Properties of Nanomaterials, Radiation Temperature and Entropy, Surface Electromagnetic Waves, and Near-Field Radiation for energy conversion devices and storage mechanisms, Nano-enhanced phase change materials.

ESL350 Energy Conservation and Management

3 Credits (3-0-0)

Overlaps with: ESL720

Pre-requisite(s): EC60 (for UG students)

Thermodynamic basis of energy conservation, Irreversible processes, Reversibility and Availability, Exergy and available energy, Energy conservation in HVAC systems and thermal power plants, Solar systems, Second law efficiency and LAW, Heat pumps and Heat pipes for space conditioning, Heat recovery and Heat exchangers, Furnaces and cooling towers, Energy conservation in buildings, U-Value of walls / roof, Ventilation systems - Fan and ducts Lighting Systems – Different light sources and luminous efficacy, Insulation use – Materials properties, Optimum thickness, Thermo economic analysis, Energy conservation in electrical devices and systems, Economic evaluation of energy conservation measures, Electric motors and transformers, Inverters and UPS, Voltages stabilizers, Energy audit and Instrumentation.

ESL351 Fundamentals of Internal Combustion Engines

3 Credits (3-0-0)

Overlaps with: Some overlap with ESL711, ESL714, MCL343, MCL345, MCL812

Introduction to internal combustion (IC) engines; internal combustion engine classifications; Fuel quality for internal combustion engines IC engine design and operating parameters; Fuel induction and injection techniques, Speed-torque characteristics, speed-power characteristics, the effect of design and operating parameters on power output, brake mean effective pressure and torque, break thermal efficiency, indicated thermal efficiency etc. supercharger, turbocharger, Pressure-crank history, ignition delay, flame speed, heat release rate, cumulative heat release rate, Engine friction, oxides of nitrogen oxides, Carbon monoxide, Unburned hydrocarbon, Particulate matter, Greenhouse gases, Formation mechanism and control measures of the engine-out emissions, Zero emission and hybrid engine, Emission norms.

ESL352 Hydrogen Economy

3 Credits (3-0-0)

Overlaps with: Some overlap with CLL723, ESL746

Hydrogen potential and role in decarbonizing the global Energy System; Hydrogen Characteristics, Forecast / Resource Assessment of Hydrogen demand and supply; Impact of Hydrogen on economy and environment, Different Pathways for Implementation of Hydrogen economy; Grey, blue and green hydrogen; Aggregated and Disaggregated models for GDP with Hydrogen and GHG Emissions.

Technology for Hydrogen production from Conventional and Renewable Energy Resources (Coal, Natural Gas, Biomass, Solar energy, Wind Energy, Nuclear energy); Hydrogen Storage (Gaseous, Cryogenic, Slush, Metal hydrides); Hydrogen Transportation (Gas grid (Pipeline network), gas tubular, liquid containers and hydrides); Application of Hydrogen in Fuel Cells and IC Engines for Transportation sectors (Automotive vehicles, Passenger Trains, Locomotives, Flights, Ships) and Industrial sectors (Ammonia industry, Fertilizer industry, Oil Refineries etc.); Role of Carbon Capture Storage/Sequestration in Hydrogen production from fossil fuels

Life Cycle Assessment of Hydrogen energy (Production to Utilization and Disposal); Analysis of Specific Energy Input to Hydrogen production from different feed-stock/resources, Well to wheel efficiency; Techno-Economic Analysis, Levelized Cost of Energy (LCOE), Average Transportation Cost

Hydrogen safety- Codes and Standards, Hydrogen fuel quality norms, Emission Norms; Infrastructure development for supply-chain Hydrogen systems; Hydrogen Energy Policy and Programs.

ESL360 Direct Energy Conversion Methods

4 Credits (3-1-0)

Overlaps with: Some overlap with ESL730

Energy classification, Sources and utilization, Principle of energy conversion, Indirect / direct energy conversion, Basic principles of design and operations of (i) Thermoelectric (ii) Thermionic converters (iii) Photovoltaic energy systems (iv) Fuel cells (v) Plasma diodes (vi) Magneto hydrodynamic Power generators and (vii) Advanced energy conversion systems.

ESL361 Power Systems and Smart Grid Operations

3 Credits (3-0-0)

*Overlaps with: Some overlap with ELL303, ELL363**Pre-requisite(s): ELL100*

Basics of generation, transmission and distribution system, per unit system, modeling of various types generators and loads, overhead and underground transmission, transmission line models, basic protection system for power system, overcurrent, distance, generator protection schemes etc., power flow analysis for transmission, basic distribution structure, three phase modeling of transformers, distribution lines, loads etc., three phase distribution system, power system analysis, operation and control in smart grid environment.

ESL370 Control Systems and Automation

3 Credits (3-0-0)

*Overlaps with: Some overlap with ELL225, MCL212, CLL261**Pre-requisite(s): ELL100, ESL260*

Measuring instruments, polyphase metering, potentiometers, electronic instruments, oscilloscopes, signal generation and signal analysis, control system and their representation, mathematical modeling of physical system, time response analysis of first order and second order system, stability, root locus, nyquist plots, bode plots, controllers, state variable analysis, controller design.

Laplace transform and its role in control systems; pressure/temperature/flow transducers and actuators; types and mechanisms of valves; applications of valves; mechanical Cams & governors and their application in fuel-air injection control in IC engines, vibration control using spring-mass-damper system, rotational motion control using gears, Computer Numerical Control (CNC) based machining, forecasting for predictive control.

ESL371 Design of Energy Systems

4 Credits (3-1-0)

*Overlaps with: Some overlap with ESL743**Pre-requisite(s): MCL140, APL106 or APL105, ESL200, ESL262, ESL263*

Introduction to design of energy system: Scope and formulation of the system design, basic steps in design process; features of modeling, material selection, modeling of energy systems; Product vs Process Design, Basic design life cycle: Problem definition with basic design considerations of various energy systems; Energy Systems Product Design Virtual product design; Laboratory scale development, prototype/pilot scale product development, actual/commercial product development; Effect of various operating parameters on structural design; Stresses in thin cylindrical shell due to internal pressure circumferential and longitudinal stresses and deformation in thin and thick cylinders – spherical shells subjected to internal pressure – Deformation in spherical shells – Lamé's theorem

Design codes- Indian Boiler Regulations (IBR), BIS, ASME standards, Data Book Utilization, analysis tools (Software),

Conventional power generation design aspects: Pumps, boiler, condenser, feedwater heaters, draught, reservoir design, penstock, headrace tunnel, tailrace tunnel, power block,

Nuclear reactors: Reactor core, first wall, blanket, reflector, thermal and radiation shields, coolant, control rods; Radiation protection and disaster management aspects;

Non-conventional power generation design aspects: Solar thermal, Solar PV, Bio-mass, small hydro, wind, fuel cell inverters, biomass gasifier.

Electrical design aspects of energy systems: Conventional power generation system: Transformer and generator auxiliary power consumption, battery system, Distributed Generation systems, basics of distributed system design.

Non-conventional power generation systems: cabling power evacuation.

ESL372 Intelligent Techniques for Energy System Analysis

3 Credits (3-0-0)

Overlaps with: Some overlap with ELL784, COL303, COL770, ELL789

Basic probability theory, probability density functions, types of distribution, uncertainty analysis, expert systems, regression methods, classification methods, descriptive data analysis, artificial neural networks, anomaly/outlier detection, soft computing methods, IoT. information flow diagrams, Lagrange multipliers, Search methods, Dynamic programming, Geometric programming, Linear programming, modeling of energy systems, Steady-state simulation and dynamic behavior analysis of large energy systems like heat exchangers, power plants, components optimization for maximum efficiency, energy system optimization.

ESL373 Computational Methods for Energy Systems

4 Credits (3-0-2)

Pre-requisite(s): MCL141/MCL142 or MCL140 & MCL242 or CLL121, CLL231 & CLL251

Importance of computational analysis in energy sector; basics of different methods in computational analysis; introduction to the governing equations, partial differential equations and ordinary differential equations; computational workflow: model development, solver and post processors; different computational techniques used for computational analysis; validation and verification of computational results; Optimization of the processes by varying design and operating parameters of energy systems, analysis of the computed results at different time scales; sources and types of error in the computational analysis; interpolation, approximation and convergence; methods of Finite element analysis: stiffness method, potential energy and Rayleigh-Ritz method, Galerkin, FE formulation, element formulation, and coordinate transformation, isoparametric formulation; Applications: problems of structural mechanics; associated flowcharts; Recent advances in computational methods: moving mesh, adaptive mesh refinement, high performance computing, coupling with machine learning; Applications of computational analysis in energy sector problems (case study).

ESL374 Smart Devices for Energy Harvesting

3 Credits (3-0-0)

Overlaps with: Some overlap with ESL730, MCL730, PYL102, PYL651, CRL726

Ambient Energy Sources: Mechanical, Light, and Thermal, Energy harvesting technologies, Fundamentals of ferroelectric materials and energy harvesting, Piezoelectric materials and energy harvesting, parametric identification and measurement techniques of piezoelectric devices, Pyroelectric materials and devices, Introduction to the triboelectric materials and devices, Working principle of triboelectric nanogenerator, Self-powered triboelectric devices, Smart functional devices to harvest waste energy

ESL375 IoT for Energy Systems

3 Credits (3-0-0)

Internet of things is becoming integral part in various energy sector application. This course would introduce students with the concepts related to architecture of internet of things (IoT), security protocols, IoT for smart grids, microgrids, and building energy management systems, water management system etc. IoT for various energy device level applications, data analytics and cloud computing for IoT applications.

ESL376 Smart Buildings

3 Credits (3-0-0)

Pre-requisite(s): ELL100

Introduction to the building energy consumptions and future predictions, steps to conduct the surveys of the existing buildings to determine the energy consumption patterns, various areas of interventions, controllers for light, HVAC and other motor based loads, thermal management of the buildings by the use of phase change materials, renewable energy based power generation in buildings for reduction of external power demand, demand response, optimal resource and load management for smart buildings. Application of IoT for smart buildings management system, effect of facade design in old and new buildings. Ancillary services, and concept of peer to peer sharing in buildings. Other aspects like thermal comfort, indoor air quality etc. for buildings.

ESL377 Optimization of Energy Systems

3 Credits (3-0-0)

Overlaps with: Some overlap with ESL743, CLL782, CLL784, CLL785, MTL103

Engineering design and optimization definitions, Trends analysis of multiple physical parameters involving in energy systems, Mathematical model for optimal energy system design, Representative

methods for the solution of the optimization problem, Optimization techniques- curve fitting, Lagrange multipliers, Search methods, Modelling of energy systems, Steady-state and transient simulation for optimization of energy systems, Components optimization for maximum efficiency, case studies.

ESL380 Basics of Nuclear Fission and Fusion

4 Credits (3-1-0)

Overlaps with: Some overlap with ESL734, PYL302, PYL569

Introduction and basic concepts (Atomic structure, Avogadro's number, isotopes, isotones and isobars, Binding energy, Einstein's mass-energy relation, radio activity and radioactive decay, cross-section, differential cross-section and reaction rates), Nuclear structure (Nuclear mass, Nuclear shell model, Single-Particle features, Collective states), Nuclear instability (alpha, beta and gamma decay), Nuclear Reactions (Energy spectra, Angular distributions, electron scattering nuclear scattering, direct reactions, compound nucleus reactions, heavy-ion reactions), Interaction of radiation and matter (Heavy charged particles, electron, gamma-rays and neutrons), Detectors and instrumentation (Gas detectors, Scintillation detectors, semiconductor detectors, neutron detectors), Biological effects of radiation (Direct-Indirect physical/chemical damage, dose/dose rate/dose distribution, damage to critical tissue, human exposure to radiation and risk assessment), Industrial and analytical applications (Industrial uses such as tracing, gauging, material modification, sterilization and food preservation, neutron activation analysis, particle induced X-ray emission, acceleration mass spectrometry), Nuclear medicine (Projection imaging, computed tomography [CT] positron emission tomography, magnetic resonance imaging [MRI] and radiation therapy), Nuclear safety (Risk assessment and monitoring, radioactive waste disposal methodology, Disaster management aspects), Power from Fission (Fission products and characteristics, thermal fission reactor, breeder reactor, Finite reactor, Reactor operation, Commercial thermal reactor [Early gas-cooled reactor. Advanced gas-cooled reactor (AGR), Pressurized water reactor (PWR), Boiling water reactor (BWR), Heavy water reactor (HWR) and recent advances]), Thermonuclear fusion (Scope of fusion for future, Q-values, reaction rates, Fusion Ignition, requirement of plasma, Reactors [Magnetic Confinement Fusion {MCF} and Inertial confinement fusion {ICF}], Current Status).

ESL381 Plasma Science

4 Credits (3-1-0)

Overlaps with: Some overlap with ESL737, PYL658

Fundamentals: Definition of plasma, Plasma criteria and Debye shielding; Particle motion concepts: single particle motion of charged particles in constant, time-varying and spatial varying electromagnetic fields, first second and third adiabatic invariants; Fluid model of plasma: dielectric description of cold plasma, Hot plasma dielectric tensor, various types of electro-static and electromagnetic waves in the cold plasma model, magneto-hydrodynamic description of plasmas, CMA diagram; Plasma diffusion: Ambipolar diffusion, diffusion in weakly-ionized, fully-ionized and magnetized plasmas, time-dependent and time independent solutions of diffusion equations and plasma resistivity, neo-classical diffusion and banana diffusion regimes; Equilibrium and stability: hydrodynamic equilibrium, beta concept, Instability classifications (two-stream, Rayleigh-Taylor, Universal and kinetic instabilities); kinetic description of plasma: governing equations, Landau damping, BGK and Van-Kampen modes, Korteweg-de Vries and nonlinear Schrödinger equations; nonlinear sheath estimates (planar, Bohm and Child-Langmuir sheaths); nonlinear plasma aspects: Non-dervative forces, Shock waves and double layers, parametric instabilities, echoes, re-connection, turbulence; Special plasmas: atmospheric pressure plasmas, non-neutral plasmas, space plasmas, dusty plasmas, solid ultra-cold plasmas.

ESL382 Plasma Sources and Diagnostics

3 Credits (3-0-0)

Overlaps with: Some overlap with ESL737

Plasma Sources: Introductory concepts; Physics of high voltage

sheaths; Particle and energy balance; Basic concepts of DC sources, RF sources (capacitively-coupled, inductively-coupled, helicon), microwave sources, resonance heated sources (electron cyclotron, ion cyclotron etc.).

Plasma Diagnostics: In-situ probes: Lang-muir probes, Capacitive probes, E-probes and other particle analyzers; Essential plasma spectroscopy measurements; Plas-ma imaging methods; Interferometry and reflectometry; Electromagnetic emission diagnostics; Underlying principle of other advanced optical diagnostics (Thomson scattering, Laser Induced Fluorescence (LIF), Laser Photo Detachment (LPD)).

ESL390 Energy Economics

3 Credits (3-0-0)

Overlaps with: Some overlap with ESL750, MCL760

Introduction to energy sector and considerations of access, security and externality; Energy demand analysis, management and forecasting, Economics of energy supply, Energy Markets – solid, liquid, and gaseous fuels as well as electricity; Energy pricing; Economics and energy-environment interaction; Energy sector reforms, Energy sector regulations.

ESL400 Energy Efficiency

3 Credits (3-0-0)

Overlaps with: Some overlap with ESL350, ESL750, ESL724, ESL714, ESL715, ESL739, ESL753, ESL770, ESL790, ESL845, ELL766, ELL772

Introduction to energy efficiency of different sectors (Industries, agriculture, commercial and residential buildings, transportation, service industries, etc.), energy intensity, calculation of energy efficiency of individual subsystem and whole system, energy auditing, energy conservation, measures of energy efficiency, carbon credit, energy efficiency vs Specific CO₂ emission, energy security, sustainability, demand side management, smart metering, energy efficiency schemes in various sectors- power plant, buildings, appliances, electric vehicles, energy efficiency in building sector, etc. Scopes of efficiency enhancements in various devices such as boilers and furnaces, pumps and motors, lighting, etc. Energy Conservation Act, standards, devices labelling, regulations such as ECBC, PAT, etc.

ESL410 Waste to Energy

3 Credits (3-0-0)

Overlaps with: Some overlap with ESL726, ESL732, ESL733, ESL735, ESL778, MSL818

Introduction: Waste as a renewable re-source, Environmental regulations, Clean air act; Global production of power from waste: Waste management hierarchy, Waste handling and safety; Circular economy and zero waste; Waste as a resource: Waste classification and composition, Assessment of energy content in waste; Waste processing and its transportation; Waste to energy technologies: Combustion technologies for traditional waste, Rotary combustors, Fluidized bed combustors, Incineration, Anaerobic digestion and landfill gas technologies, Refuse derived fuels through thermo-chemical route, Gasification, Pyrolysis, Plasma gasification/pyrolysis, Syngas utilization; Nuclear waste management; Waste to energy plants and environment: Emission limits for waste combustion, Emission control technologies.

ESL420 Industry Relevant Photovoltaic Technologies

3 Credits (3-0-0)

Overlaps with: Some overlap with ESL360, ESL730, ESL755, ELL743

Brief introduction of solar photovoltaics science and engineering, Performance parameters of solar cells based on large area effect, Basic industrial processes of photo-voltaic technologies: active electronic materials cleaning process, pn-junction formation using various techniques, metal contacts formation, lamination of solar panels for protection, wiring and testing of solar photovoltaic modules. Different Technologies: First generation silicon photovoltaic

technology. Thin Films based photovoltaic technologies. Advanced silicon photovoltaic technologies based on the Passivating emitter rear contacts (PERC), Tunnel oxide based passivating contacts (TOPCon), Interdigitated back contacts (IBC), and Silicon heterojunction (SHJ). Photovoltaic technologies related to space applications. Next generation photovoltaic technologies based on tandem solar cells to achieve high power conversion efficiency.

ESL450 Hybrid Vehicles

3 Credits (3-0-0)

Overlaps with: Some overlap with ESL780, MCL345

Fundamentals of hybrid vehicles (internal combustion engines and electrical system); Classification of Hybrid electric vehicles; the architecture of hybrid drive trains- Series, Parallel, Series-Parallel hybrid; Design principles of HEVs; Basic components of Hybrid electric systems;

Design of HEV drivetrain: Series, parallel, series-parallel, mild and plug-in; Transmission mechanism: clutch, Gear-box, cam profiling; Regenerative braking- Fundamentals and mechanism; Control system for hybrid electric vehicles; Torque-speed characteristics of hybrid vehicles; Driving cycles for hybrid vehicles.

Different types of Battery, specific power density, state of charge, range with respect to the speed of hybrid vehicles, Fuel economy improvement with alternative fuelled hybrid systems; Hydrogen fuelled hybrid vehicles; Energy efficiency and CO₂ emission; Life cycle analysis of hybrid electric vehicle (HEV).

ESL480 Plasma Chemistry

3 Credits (3-0-0)

Overlaps with: Some overlap with ESL737

Basic concepts of plasma, Thermal and non-thermal plasma chemistry, Elementary chemical reactions in plasmas, Various atomic and molecular collisions, Collision cross section, frequency and rate constant, Plasma sheath and potential; Chemical equilibrium and kinetics; Enthalpy and Gibbs free energy; Surface processes- plasma wall interaction- Adsorption, desorption, sticking coefficient, Chemical surface reactions, Surface diffusion. Ion bombardment; Uniform density discharge model, Particle and energy balance, Plasma diagnostics- Probe measurements, Emission and absorption spectroscopy, Applications of surface and volume plasma chemistry: Plasma etching, Chemical vapour deposition, flue and exhaust gas treatment, Excimer light source.

ESL481 Plasma based Technologies for Functional Materials

3 Credits (3-0-0)

Overlaps with: Some overlap with ESL744, ESL737, MLL341, PHL702

Introduction to plasmas; Plasma sources; DC plasmas, Capacitively and inductively coupled Plasma Sources; Micro wave and ECR Plasma Source; Magnetron Sputtering, Plasma Enhanced Chemical Vapour Deposition (PECVD); Plasma etching, PIII, Plasma processes for thin films, Smart materials; Plasma process for Si based films, materials for lithium ion batteries (LIB), thermo-electric films, Hydrogen storage materials, 2-D materials, superconductive films.

ESL490 Wind and Tidal Wave Energy

3 Credits (3-0-0)

Overlaps with: Some overlap with ESL340, ESL740, CVL862, ASL650, ASL826, APL402

Introduction to waves and tides, Ocean waves: formation, characterisations, wave climate, energy content (Relations of ocean currents and waves with the driving forces- wave dynamics), resources and measurement, energy absorption, mechanical energy conversion, rotating and linear generators. Wave power technologies: oscillating wave columns (OWC) and point-absorbers (PA). Basics of sloshing dynamics (Fluid structure Interaction), Offshore structures – buoys, mooring and anchoring design, tension leg platforms, umbilical cable etc., FLNG, System design aspects- Ocean Thermal Energy Conver-

sion (OTEC), tidal energy harnessing by basin design- sluice and estuary design. Marine energy harnessing technology, Transmission lines, History, legal aspects, environmental assets, biological effects, conflicts of interest, availability and re-sources.

ESL710 Energy, Ecology and Environment

3 Credits (3-0-0)

Interrelationship between energy and environment, Sun as a source of energy, nature of its radiation, Biological processes, photosynthesis, Autecology and Synecology, Population, Community Ecosystem (wetland, terrestrial, marine) Food chains, Ecosystem theories. Sources of energy, Classification of energy sources, Environmental issues related to harnessing to fossil fuels (coal, oil, natural gas), geothermal, tidal, nuclear energy, solar, wind, hydropower, biomass, Energy flow and nutrient cycling in ecosystems, Environmental degradation, primary and secondary pollutants. Thermal/ radioactive pollution, air and water pollution, Micro climatic effects of pollution, Pollution from stationary and mobile sources, Biological effects of radiation, heat and radioactivity disposal, Acid rain, Global warming and greenhouse gases, Ozone layer depletion.

ESL711 Fuel Technology

3 Credits (3-0-0)

Solid, liquid and gaseous fuels, Coal as a source of energy and chemicals in India, Coal preparation and refining, Carbonization, Gasification and liquefaction of coal and lignite, Principle of combustion, Petroleum and its derived products, Testing of liquid fuels, Petroleum refining processes, Inter-conversion of fuels, Natural gases and its derivatives, sources, potential, Gas hydrates, Combustion appliances for solid, liquid and gaseous fuels, Introduction to nuclear fuel, RDF, Bio-fuels, etc.

ESL714 Power Plant Engineering

3 Credits (3-0-0)

Types of thermal power stations, Steam power stations based on fossil fuels, Economy and thermal scheme of the steam power stations, Thermal power plant equipment boilers, super heaters, super critical steam generator, economizers, feed water heater, condensers, combustion chamber and gas loop, turbines, cooling towers, etc. Gas turbine power stations, Combined cycle power plants, Internal combustion engine plant for peak load, standby and start up, Elements of hydropower and wind turbine, Elements of nuclear power plants, Nuclear reactors and fuels. Recent advances in power plants (IGCC, super critical power plants, etc.). Case studies, Introduction to solar power generation, Sterling engine, Decentralized power technologies.

ESL715 Electrical Energy Management

3 Credits (3-0-0)

Importance of energy management, Electrical energy auditing methods, demand control, load scheduling/shifting, Energy management centres and their functions, Economic operation of power system, Unit commitment, Supervisory control and scada systems, Optimal resource management in micro grid/decentralized environment, Power factor improvement, Energy efficient motors, Pumps, Variable frequency drives, Energy efficient lighting, Energy conservation in various electrical devices.

ESL718 Power Generation, Transmission and Distribution

3 Credits (3-0-0)

Generation: Synchronous generator operation, Power angle characteristics and the infinite bus concept, dynamic analysis and modeling of synchronous machines, Excitations systems, Prime-mover governing systems, Automatic generation control.

Auxiliaries: Power system stabilizer, Artificial intelligent controls, Power quality.

AC Transmission: Overhead and cables, Transmission line equations, Regulation and transmission line losses, Reactive power compensation, Flexible AC transmission.

HVDC transmission: HVDC converters, advantages and economic considerations, converter control characteristics, analysis of HVDC link performance, Multi-terminal DC system, HVDC and FACTS.

Distribution: Distribution systems, conductor size, Kelvin's law, performance calculations and analysis, Distribution inside and commercial buildings entrance terminology, Substation and feeder circuit design considerations, distribution automation, Futuristic power generation.

ESL720 Energy Conservation

3 Credits (3-0-0)

Introduction, Thermodynamics of energy conservation, Energy and exergy concepts, Irreversibility and second law analysis and efficiency of thermal systems such as mixing, throttling, drying and solar thermal systems, Thermal power plant cycles. Refrigeration and air conditioning cycles, thermal insulation in energy conservation, energy conservation through controls, electric energy conservation in building heating and lighting, energy efficient motors, Tariffs and power factor improvement in electrical systems, Energy conservation in domestic appliances, transport, energy auditing, energy savings in boilers and furnaces, energy conservation Act, Energy conservation in small scale domestic appliances and agriculture.

ESL722 Integrated Energy Systems

3 Credits (3-0-0)

Pattern of fuel consumption: agricultural, domestic, industrial and community needs, Projection of energy demands, Substitution of conventional sources by alternative sources and more efficient modern technologies, Potential, availability as well as capacity of solar, wind, biogas, natural gas, forest produce, tidal, geothermal, mini-hydro and other modern applications, Hybrid and integrated energy systems, Total energy concept and waste heat utilization, Energy modeling to optimize different systems.

ESL724 Energy Audit

3 Credits (3-0-0)

Need for energy audit; Energy Conservation Act 2001 and other legislative frameworks; Types of energy audit; energy accounting and analysis; Instrumentation and measurement techniques for energy audit; Energy audit of buildings; HVAC audit; Energy audit of lighting and other electrical systems, motors, lifts, pumps, fans, and blowers; Energy audit of diesel or gas or alternative fuel based captive power generation systems; Energy audit for gas turbine power plant, Energy auditing of boilers, steam distribution systems, furnaces, stoves and burners, compressed air networks, heat exchangers, cooling towers etc.; Identification and assessment of energy saving opportunities; Preparing energy audit reports.

ESL726 Waste Heat Recovery

3 Credits (3-0-0)

Pre-requisite(s): EC 75 (for UG Students in Minor Area)

Introduction to Waste heat recovery, Classifications, Principles, Utilizations, Strategy of using waste heat recovery, Basic Heat Exchanger Design Concepts, Heat Exchanger equipment classifications, Steam generation equipment, Power plant heat recovery systems, Commercial waste heat recovery systems with detailed study of Recuperators, Radiation/Convective Hybrid Recuperator, Ceramic Regenerator, Introduction to efficient building design.

ESL727 Energy and Environment

3 Credits (3-0-0)

Introduction (Basic definitions, link with ecology, resource classifications), Energy Transfer and Nutrient cycling, Environmental Impact of conventional resources, Alternate mitigation aspects using non-conventional resources, air pollution, water pollution, soil pollution, thermal pollution, e-waste pollution, radioactive degradation, global effects and climate change.

ESL729 Renewable Energy and Environment

3 Credits (3-0-0)

Current challenges in terms of environmental pollutions, Sources of pollution and global warming, harmful effects of environmental

pollution, preventive measures and protocols to minimize environmental damage, availability and economic aspects of renewable energy sources, effects of renewable energy sources on the environment.

ESL730 Direct Energy Conversion

3 Credits (3-0-0)

Basic science of energy conversion, Indirect versus direct conversion, Physics of semiconductor junctions for photovoltaic and photoelectrochemical conversion of solar energy, Fabrication and evaluation of various solar cells in photovoltaic power generation systems, Technology and physics of thermo-electric generations, Thermoelectric materials and optimization studies, Basic concepts and design considerations of MHD generators, Cycle analysis of MHD systems, Thermionic power conversion and plasma diodes, Thermodynamics and performance of fuel cells and their applications.

ESL731 Biomass - A Renewable Resource

3 Credits (3-0-0)

Pre-requisite(s): EC 75 (for UG Students in Minor Area)

Biogas-animal dung and agroresidues and other cellulose wastes, ethanol from wheat or corn, sugar cane, sweetsorghum, beet roots, grapes, starch etc. pyrolysis of biomass. Direct combustion of biomass, Improved stoves routes.

Second Generation Biofuels:- Biodiesel from oil seeds, Gasification of agroresidues, sawdust etc, Micro-power generation through biomass gasifiers, waste incineration fluidized bed combustion of biomass. Third Generation Biofuels:- Algae based Biodiesel, Ethanol, Hydrogen, alcohols from agroresidues, chemical composition of lignocellulosic biomass fuels and chemicals from each

component biomass (Hemicellulose, Cellulose, and Lignin), Chemical, Thermochemical and Biochemical processes, Availability of biomass, petrocrops, aquatic biomass and its potential, concept of bioeconomy and biorefineries.

ESL732 Bioconversion and Processing of Waste

3 Credits (3-0-0)

Biomass and solid wastes, Broad classification, Production of biomass, photosynthesis, Separation of components of solid wastes and processing techniques, Agro and forestry residues utilisation through conversion routes: biological, chemical and thermo chemical, Bioconversion into biogas, mechanism, Composting technique, Bioconversion of substrates into alcohols, Bioconversion into hydrogen, Thermo chemical conversion of biomass, conversion to solid, liquid and gaseous fuels, pyrolysis, gasification, combustion, Chemical conversion processes, hydrolysis and hydrogenation, Solvent extraction of hydrocarbons, Fuel combustion into electricity, case studies.

ESL733 Organic Waste to Energy Conversion Technology

3 Credits (3-0-0)

Different sources of organic and synthetic waste from residential sectors, Commercial sectors, municipal sectors, Industrial sectors, and agriculture and forest residues, Estimation of energy potential of organic waste from these sectors, GHG emission reduction potential with waste, material efficiency, Concept of zero effluent based eco-industrial park, Lifecycle assessment (LCA) and its application to sustainable waste management, Classification of the organic wastes based on incinerable, Land fillable and recyclable, Various technologies for segregation of organic matter from the waste, Physico-chemical properties of organic matter, Various technologies for conversion from the organic waste to energy: Thermo-chemical conversion (incineration, combustion, gasification / plasma gasification, pyrolysis/plasma pyrolysis, and esterification), Bio-chemical conversion (anaerobic digestion, dark fermentation, microbial system). Conversion of energy/fuels derived from waste to electrical power: steam turbine power plant, Internal combustion engines, Microbial fuel cell, Solid oxide fuel cell, Technologies for emission reduction for waste to energy systems, Future technologies for zero effluent industrial parks, Government policies and norms for waste to energy, and case studies/numerical problems for the industries including sugar, cement and paper.

ESL734 Nuclear Energy

3 Credits (3-0-0)

Introduction: Scope of nuclear energy (fission and fusion energy), typical reactions.

Basics Concepts: Binding Energy of a nuclear reaction, mass energy equivalence and conservation laws, nuclear stability and radioactive decay, radioactivity calculations.

Interaction of Neutrons with Matter: Compound nucleus formation, elastic and inelastic scattering, cross sections, energy loss in scattering collisions, polyenergetic neutrons, critical energy of fission, fission cross sections, fission products, fission neutrons, energy released in fission, r-ray interaction with matter and energy deposition, fission fragments.

The Fission Reactor: The fission chain reaction, reactor fuels, conversion and breeding, the nuclear power resources, nuclear power plant & its components, power reactors and current status.

Reactor Theory: Neutron flux, Fick's law, continuity equation, diffusion equation, boundary conditions, solutions of the DE, group diffusion method, Neutron moderation (two group calculation), one group reactor equation and the slab reactor Health Hazards: radiation protection & shielding.

Nuclear Fusion: Fusion reactions, reaction cross-sections, reaction rates, fusion power density, radiation losses, ideal fusion ignition, Ideal plasma confinement & Lawson criterion.

Plasma Concepts: Saha equation, Coulomb scattering, radiation from plasma, transport phenomena.

Plasma Confinement Schemes: Magnetic and inertial confinement, current status.

ESL735 Hazardous Waste Management

3 Credits (3-0-0)

Sources and classification of hazardous wastes, Assessment of exposure potential: Transport processes, Overview of waste management problems, Guidelines for handling hazardous wastes, Energy from organic hazardous wastes, Chemical waste treatment processes, Physical waste treatment processes, Biological waste treatment processes, Thermal waste treatment processes, Nuclear waste treatment processes, Waste elimination option, Domestic hazardous waste, Hazardous waste management options, Toxic metallic waste, Biomedical waste, Remediation of hazardous waste contaminated soils, Engineering issues in waste remediation, case studies.

ESL737 Plasma Based Materials Processing

3 Credits (3-0-0)

Introduction: Plasma based processing of materials

Plasma Concepts: Plasma fluid equations, single particle motions, unmagnetized plasma dynamics, diffusion and resistivity, the DC sheath and probe diagnostics.

Basics of Plasma Chemistry: Chemical reactions and equilibrium, chemical kinetics, particle and energy balance in discharges.

Low Pressure Plasma Discharges: DC discharges, RF discharges - Capacitively and inductively coupled, microwave, ECR and helicon discharges.

Low Pressure Materials Processing Applications: Etching for VLSI, film deposition, surface modification and other applications (plasma nitriding, plasma ion implantation, biomedical and tribological applications).

High Pressure Plasmas: High pressure non-equilibrium plasmas, thermal plasmas – the plasma arc, the plasma as a heat source, the plasma as chemical catalyst.

Applications of High Pressure Plasmas: Air pollution control, plasma pyrolysis and waste removal, plasma based metallurgy – ore enrichment, applications in ceramics, plasma assisted recycling.

ESL738 Power System Planning and Operation

3 Credits (3-0-0)

Reliability Indices: Unit availability, Capacity outage probability tables, Loss of load indices, operation of interconnected systems, Restructured power system operation. Applications of optimization techniques for power system planning, Generation expansion

planning, Transmission expansion planning, Reactive power planning, combined generation, Transmission, reactive expansion planning, Generation/transmission/reactive planning in the presence of renewable energy sources.

ESL739 Bioenergy: Resources, Technologies and Applications

3 Credits (3-0-0)

Introduction to bioenergy; biomass harvesting; availability and assessment of biomass for bioenergy applications; characterization of biomass feedstock (physico-chemical properties, ultimate, proximate, compositional, calorific value, thermogravimetric, differential thermal and ash fusion temperature analyses); classification of biomass feedstock: first, second and third generation biofuels; hybrid biofuels, basic principles of chemical thermodynamics; carbon neutral fuels.

Different pre-treatment processes of biomass; different production routes for biomass conversion to biofuels: biochemical methods (anaerobic, enzymatic- saccharification and fermentation process, and dark fermentation, ABE fermentation); chemical processes (trans-esterification, hydro-processing, micro-emulsification); thermochemical methods (combustion, gasification, pyrolysis, partial oxidation, auto-thermal reforming) for biofuels production including synthesis gas, bio-hydrogen, ethanol, butanol, biogas, methanol, dimethyl ether and paraffinic fuels; Biomass compaction (briquetting and palletisation); biofuel quality upgradation; and biomass and biofuel fuel quality norms.

Biomass based incineration plant for heat generation; co-firing of biomass for heat generation for industrial processes; Biomass fuelled combustion devices for cooking and heating applications; Utilization of biomass in external combustion engines including steam turbine power plant and Stirling engines; Case studies for setting up biomass based small power plant (~ 1MW) capacity for rural electrification; utilization of biofuels in gas turbine, internal combustion engines and fuel cells; analysis of carbon neutral and carbon credit.

ESL740 Non-conventional Sources of Energy

3 Credits (3-0-0)

Types of non-conventional sources,

Solar energy: principles and applications, Efficiency of solar thermal and PV systems;

Biomass: generation, Characterization, Biogas: aerobic and anaerobic bio-conversion processes;

Mini/micro hydro power: classification of hydropower schemes, classification of water turbine, Turbine theory, Essential components of hydroelectric system, system efficiency;

Fusion: Basic concepts, fusion reaction physics, Thermonuclear fusion reaction criteria, Confinement schemes, Inertial and magnetic confinement fusion, current status;

Wind Energy: Origins, Basic principles of aerodynamics, Measurement and distribution, Power extraction;

Geothermal, Tidal, Wave, and Ocean Thermal Energy sources.

ESL742 Economics and Financing of Renewable Energy Systems

3 Credits (3-0-0)

Pre-requisite(s): EC 75 (for UG students in Minor Area)

Overview of renewable energy technologies. Relevance of economic and financial viability evaluation of renewable energy technologies, Basics of engineering economics, Financial feasibility evaluation of renewable energy technologies, Social cost – benefit analysis of renewable energy technologies. Technology dissemination models, Volume and learning effects on costs of renewable energy systems, Dynamics of fuel substitution by renewable energy systems and quantification of benefits. Fiscal, financial and other incentives for promotion of renewable energy systems and their effect on financial and economic viability. Financing of renewable energy systems, Carbon finance potential of renewable energy technologies and impact of other incentives. Software for financial evaluation of renewable energy systems. Case studies on financial and economic feasibility evaluation of renewable energy projects.

ESL743 Optimal Design of Energy Systems

3 Credits (3-0-0)

Engineering design and optimization definitions, Concepts pertaining to system design and simulations, Information flow diagrams, Optimization techniques- Curve fitting, Lagrange multipliers, Search methods, Dynamic programming, Geometric programming, Linear programming, Modelling of energy systems, Steady-state simulation and Dynamic behaviour Analysis of large energy systems like heat exchangers, Power plants, Components optimization for maximum efficiency, Energy storage optimization.

ESL744 Plasmas for Energy and Environment

3 Credits (3-0-0)

Introduction to plasmas; thermal and non-thermal plasmas; Laboratory plasma sources, Plasma in the Industry from the energy perspective (Fusion: the green technology; Plasma-surface modifications, Polymers, Nano-powders, Textile, lasers, Lamps and Displays, Power demand, Aerospace and Plasma thrusters, Micro-satellite application, Supercomputers) Environment perspective (Environmental control of exhaust gas treatment, Plasma treatment of Volatile Organic Compounds and some other plasma ecological technologies, Collection and removal of fine particles in plasma chambers; Hazardous waste problem and Plasma-assisted recycling; Biomedical and health).

ESL745 Environmental Audit and Impact Assessment

3 Credits (3-0-0)

Environmental setting-air, water etc., Sampling and monitoring-Design, Types and objectives; Ambient and stack/source air quality monitoring and analysis; Waste water monitoring and analysis; Environmental audit-detailed procedure; National environmental policy; Methods of impact identification; Methodology of environmental impact studies.

ESL746 Hydrogen Energy

3 Credits (3-0-0)

Introduction of Hydrogen Energy Systems: Hydrogen pathways introduction – current uses, General introduction to infrastructure requirement for hydrogen production, storage, dispensing and utilization, and Hydrogen production power plants.

Hydrogen Production Processes: Thermal-Steam Reforming – Thermo chemical Water Splitting – Gasification – Pyrolysis, Nuclear thermo catalytic and partial oxidation methods. Electrochemical – Electrolysis – Photo electro chemical.

Biological: Photo Biological – Anaerobic Digestion – Fermentative Micro-organisms.

Hydrogen Storage: Physical and chemical properties – General storage methods, compressed storage – Composite cylinders – Glass micro sphere storage - Zeolites, Metal hydride storage, chemical hydride storage and cryogenic storage.

Hydrogen Utilization: Overview of Hydrogen utilization: I.C. Engines, gas turbines, hydrogen burners, power plant, refineries, domestic and marine applications, Hydrogen fuel quality, performance, COV, emission and combustion characteristics of Spark Ignition engines for hydrogen, back firing, knocking, volumetric efficiency, hydrogen manifold and direct injection, fumigation, NOx controlling techniques, dual fuel engine, durability studies, field trials, emissions and climate change.

Hydrogen Safety: Safety barrier diagram, risk analysis, safety in handling and refuelling station, safety in vehicular and stationary applications, fire detecting system, safety management, and simulation of crash tests.

ESL748 Economics of Energy Conservation

3 Credits (3-0-0)

Pre-requisite(s): EC 75 (for UG Students in Minor Area)

Overview of measures and approaches towards improved energy efficiency and energy conservation in various sectors of the economy; Need for studying economics of energy conservation; Identification and quantification of costs and benefits associated with energy conservation projects; Time value of money, discount rate and basic

formulae of engineering economics; Measures of financial/economic performance for appraisal/evaluation of energy conservation projects; Approaches for considering uncertainty in appraisal/evaluation; Existing and potential incentives for promoting energy conservation measures, regulations and policy measures; Carbon mitigation benefits; Development of techno-economic models; Software for economic assessment of energy conservation projects; Financing of energy conservation projects; Case studies.

ESL749 Developing Energy Efficiency and Renewable Energy Projects

3 Credits (3-0-0)

Relevance of developing energy efficiency and renewable energy projects, Key project development concepts, Project motivation- key drivers-pre development- gauging market characteristics that provide motivation for the project and assessment of market readiness, Project development framework-essential elements, project development environment including existing policy environment- relevant codes (such as ECBC), Pre-investment phase – assessing potential sites, identifying partners, Assessment of commercially available energy technologies for improving energy efficiency and harnessing renewable energy, preparation of business plan (that includes feasibility study, engineering design, Financial closure, permitting activities and related documentation and agreements), consensus with project stakeholders, Implementation phase – Procurement, land acquisition, site preparation, construction, installation, commissioning of the project, operation of the facility, Actual implementation of the business plan, Monitoring and evaluation of the business and the project performance, Issues in implementation of energy efficiency and renewable energy projects, Essential areas for strong project development in renewable energy - site, resource, permits, technology, team and capital, Size and diversity of potential project sponsors and also of projects in the field of renewable energy and energy efficiency, Risks with energy efficiency and renewable energy projects and appropriate de-risking/ mitigation measures and approaches, dispute resolution, Role of policies and support measures in promoting energy efficiency and renewable energy, Developing community driven projects, Developing projects for improving energy access, socially inclusive projects, Issues in using public lands for developing renewable energy projects, Various considerations in selecting local versus imported technologies, Challenges in implementing energy efficiency in public sector within government financial and other regulations, Environmental impact and sustainability assessment of energy efficiency and renewable energy projects and projects while addressing environmental issues, Utility scale versus local projects, Examples and Case Studies – developing PV/wind power projects, projects for enhanced LED use in domestic, commercial, institutional and industrial sectors, environmental management projects.

ESL750 Economics and Planning of Energy Systems

3 Credits (3-0-0)

Relevance of financial and economic feasibility evaluation of energy technologies and systems, Basics of engineering economics, Financial evaluation of energy technologies, Social cost benefit analysis, Case studies on techno-economics of energy conservation and renewable energy technologies. Energy demand analysis and forecasting, Energy supply assessment and evaluation, Energy demand – supply balancing, Energy models. Energy – economy interaction, Energy investment planning and project formulation. Energy pricing. Policy and planning implications of energy – environment interaction, Clean development mechanism. Financing of energy systems. Energy policy related acts and regulations. Software for energy planning.

ESL751 Renewable Energy Resource Assessment and Forecasting

3 Credits (3-0-0)

Types of non-conventional sources, Solar energy: principles and applications, meteorological considerations for solar power: solar resource assessment, solar forecasting for different timescales, uncertainty estimation evaluation of solar forecasting skill, Wind energy: wind resource assessment, measurement and distribution, Assessment techniques, Site selection for wind monitoring stations,

wind forecasting for different timescales using statistical and numerical methods. Biomass: Sources of biomass, measurement of productivity and statistical analysis of data, Forecasting based on statistical analysis. Geothermal energy: Geological survey for geothermal regions, Types of geothermal resources, Thermal gradient measurements, Monitoring micro seismic activity, Reflection seismic, Deep exploration drilling and testing with estimation. Ocean thermal, waves and tidal energy: Measurement and statistical analysis for assessment and forecasting Ocean thermal, waves and tidal energy.

ESL752 Carbon Audit and Management

3 Credits (3-0-0)

Greenhouse gas emissions from the energy sector and their time trend; Climate change and other potential impacts of enhanced greenhouse effect caused by anthropogenic emissions primarily from extraction, conversion, transport, storage and utilization of energy carriers; Carbon foot print; Carbon audit; Carbon management-tools and accounting techniques; Life cycle assessment; Policies, regulations, protocols and standards; Carbon credits and carbon economics.

ESL753 Solar Thermal Technologies and Applications

3 Credits (3-0-0)

Solar radiation, Solar angles, classifications of Solar thermal collectors, Non-concentrating and concentrating collectors, Heat transfer fluids, Tracking mechanisms, Emerging solar thermal technologies, Application of solar thermal technologies: Power generation, Industrial process heating, Water distillation, Refrigeration, Building heating and cooling, Cooking, Drying, Thermal energy storage systems: Sensible, Latent and Thermochemical energy storage, Integration of thermal energy systems with various end use applications, Economic analyses of solar thermal energy systems, Life cycle assessment of solar thermal energy systems.

ESL754 Nanomaterials for Energy Applications

3 Credits (3-0-0)

Nano-material Synthesis and Characterization Techniques: Synthesis of nanomaterial with 0D, 1D, 2D and 3D structures. Basic characterization techniques of nanomaterial; X-ray characterization (X-ray sources; wide angle and extended x-ray absorption technique), Electron microscopy: high resolution imaging (SEM/TEM), defects in nano-materials. Spectroscopy; electron energy-loss mechanisms, electron filtered imaging and optical spectroscopy of metal/ semiconductor nanoparticles.

Nanolithography and Device Fabrication Techniques: EUV lithography, Phase-shifting photolithography, X-ray lithography, Electron Beam Direct Writing System, Focused ion beam (FIB) lithography, Neutral atomic beam lithography, Plasma-aided nanofabrication, Soft Lithography, Nano sphere Lithography etc. Nanofabrication Using a de Broglie Wave-Electron Beam Holography, Atomic Beam Holography and Nanometer Lithography Using Organic Positive/Negative Resists. Nano-photonics and optoelectronic devices: Advanced photonics and optoelectronic devices; Photo-voltaic, LEDs and Lasers. Spin tunneling devices, Magnetic tunnel junctions, Tunneling spin polarization, Tunnel-based spin injectors, Magnetic tunnel transistor, Memory devices and sensors and spintronic biosensors.

Nanotechnology in other energy related Fields: Application of Nanotechnology in other Advanced Energy Related Fields; Energy storage systems, Fuel Cells, Battery, Super-capacitors, air/water purification, and removal of domestic and outdoor air pollutants, Biomedical application, Aerospace and defense technology.

ESL755 Solar Photovoltaic Devices and Systems

3 Credits (3-0-0)

Photovoltaic materials bulk and thin film forms. The role of microstructure (single crystal, multi crystalline, polycrystalline, amorphous and nano-crystalline) in electrical and optical properties of the materials. Different cell design and the technology route for making solar cells. Different methods of characterization of materials and devices. Applications of Photovoltaic for power generation from few watts to Megawatts.

ESL756 Energy Policy and Planning*3 Credits (3-0-0)*

Energy (and power) policies in the country, Tariffs and subsidies, Energy utility interface, Private sector participation in power generation, State role and fiscal policy, Energy and development, National energy plan, Role of modeling in energy policy analysis, Energy data base, Energy balances, Flow diagrams, Reference energy system, Energy demand analysis, Trend analysis, Econometric models, Elasticity approach, Input-output models, Simulation/process models, Energy supply analysis, Costs of exploration and economics of utilization of depletable and renewable resources, Scarcity rent, International energy supply, Energy demand supply balancing, Energy -economy interaction, Energy investment planning, Energy environment interaction, Energy Pricing. Can we add energy policy in India?

ESL757 Renewable Energy Regulations and Law*3 Credits (3-0-0)*

Introduction, Energy acts and regulations, building energy codes and environmental emissions related norms, institutional structure for and incentives and other support measures for promoting renewable energy technologies, complimentary policies on energy conservation and environmental emissions mitigation, Regulations pertaining to renewable energy project establishment as well as integration with the existing supply structure, Regulations for energy pricing and its trading.

ESL758 Carbon Capture and Storage*3 Credits (3-0-0)*

Introduction to source of CO₂ (Greenhouse gas) from thermal energy systems and their Global warming potential (GWP), carbon and CO₂ cycle, Scenario of CO₂ concentration in atmosphere, Relationship between radiative forcing and greenhouse gas concentration, Estimation of the equilibrium surface temperature change, and global warming and climate change. Mechanism of CO₂ emission formation during combustion in power plants (steam turbine, gas turbine and internal combustion engines), CO₂ emission reduction by use of alternative fuels and energy efficiency improvement in thermal energy system, Measurement and analysis of CO₂ emission in heat engines / power plants / thermal energy system. Carbon capture: different methods (physical / chemical / biological) of Carbon capture from power plants, CO₂ capture through pre-combustion methods, Oxygen-combustion method, Post-combustion methods (physical solvents/sorbents, membranes, cryogenic fractionation), Chemical-looping combustion and algae species. Carbon storage under empty oil well, Ocean storage, etc. Carbon sequestration: mineral carbonation, Photosynthesis of plants, Fuel production, refrigerant, Dry ice, Fertilizer, Working fluid for power plants, Industrial applications (textile, paint, mining, oil etc.) and Case studies / numerical calculations for energy input requirement for CCS system.

ESL760 Heat Transfer*3 Credits (3-0-0)*

General heat conduction equation with heat generation, Analysis of extended surfaces, transient (and periodic) heat conduction, Two dimensional heat conduction problems and solutions, Theory of convective heat transfer, Boundary layer theory, Heat transfer in duct flows laminar and turbulent, Boiling, condensation and heat exchangers, Laws of thermal radiation, Radiation heat transfer between black and grey bodies, Numerical solutions of radiation network analysis, Thermal circuit analysis and correlations for various heat transfer coefficients, Overall heat transfer.

ESL764 Environmental Economics*3 Credits (3-0-0)*

Economic development and the environment, Relevance of environmental economics, Economic efficiency and markets, The economics of environmental quality, Frameworks for environmental cost and benefit analysis, criteria for evaluating environmental initiatives, Command and control strategies, Risk and uncertainty, Incentive based strategies - emission taxes and subsidies, Transferable discharge permits, Environmental policies, International environmental agreements.

ESL766 Environmental Regulations*3 Credits (3-0-0)*

Environmental legislation and strategies to control pollution, Standards and setting criterion, Role of national and international agencies in dealing with environmental aspects. Standards developed by ministry of environment and forest, Sampling and analysis techniques, Data interpretations and relationships for the design of treatment facilities. Regulations for pollution controls of water, air industrial, automobile, Noise and hazardous waste environmental audit, Public liability insurance, Environment management systems, Catalytic converters in vehicles in metropolitans, EURO standards, Bharat standards.

ESL768 Wind Energy and Hydro Power Systems*3 Credits (3-0-0)*

Introduction, General theories of wind machines, Basic laws and concepts of aerodynamics, Micro-siting, Description and performance of the horizontal-axis wind machines, Blade design, Description and performance of the vertical-axis wind machines, The generation of electricity by wind machines, case studies, Overview of micro mini and small hydro, Site selection and civil works, Penstocks and turbines, Speed and voltage regulation, Investment issues, load management and tariff collection, Distribution and marketing issues, case studies, Wind and hydro based stand-alone / hybrid power systems, Control of hybrid power systems, Wind diesel hybrid systems.

ESL770 Solar Energy Utilization*3 Credits (3-0-0)*

Solar radiation and modeling, solar collectors and types: flat plate, concentrating solar collectors, advanced collectors and solar concentrators, Selective coatings, Solar water heating, Solar cooking, Solar drying, Solar distillation and solar refrigeration, Active and passive heating and cooling of buildings, Solar thermal power generation, Solar cells, Home lighting systems, Solar lanterns, Solar PV pumps, Solar energy storage options, Industrial process heat systems, Solar thermal power generation and sterling engine, Solar economics.

ESL771 Instrumentation and Control in Energy Systems*3 Credits (3-0-0)*

Basic measurement concepts, Measurement errors, Thermo-flow measurement – Pressure, Velocity, Force, Temperature, Thermal radiation, Heat flux, Humidity, Uncertainty analysis, Measurement of wind speed, Wind direction, Solar irradiance, Head and discharge for hydro systems; Controls of solar and wind energy systems. Measurement sensors for electrical systems: Voltage, Current, Frequency, Temperature, Phase sequence measurement, Current transformers, Potential transformers, Phase difference measurements other measuring devices. Analog signal conditioning, A/D, D/A converters, Digital data processing, Sample and hold circuits, Clipping circuits, Opto-couplers, PMU, PMDC. General purpose control devices, feedback/open control loop, SISO, MIMO systems, State space representation of system equations, Stability analysis of control systems: Eigen values, Eigen vectors, S-domain analysis. Measurement and control of harmonics in electrical systems. Air pollution sampling and measurement of particulates, SO_x, NO_x, CO, O₃, Hydrocarbons.

ESL772 Energy Storage*3 Credits (3-0-0)*

Sensible Thermal Energy Storage, Latent Energy Storage, Thermal Management System design using Latent Thermal Energy Storage, Optimization of Thermal Energy Systems, Thermochemical heat storage system, Battery Electrical Energy Storage Systems, Pumped storage systems, Other electrical energy storage systems, Integration of energy storage systems, energy storage system optimization.

ESL773 Battery Storage*3 Credits (3-0-0)*

Introduction to energy storage systems and devices, Rechargeable batteries and their Fundamental electrochemistry, Lithium batteries, Nickel metal hydride battery, Lead-acid battery, High temperature batteries for back-up applications, Flow batteries for load leveling

and large scale grid application, Ni-Hydrogen batteries for space and marine applications, Manufacturing technologies of batteries, Sustainable design of batteries, Hybridization of battery, Battery recycling technologies, Battery applications for stationary and secondary use, Battery chargers and battery testing procedures, Battery management, Regulations and safety aspects of high voltage batteries, Super capacitors.

ESL774 Quantitative Methods for Energy Management and Planning

3 Credits (3-0-0)

The necessity and the levels of optimization of energy systems: synthesis, design and operation, Laws of probability and Probability distribution function; Basics principles of calculus methods, Mathematical methods for solution of the optimization problem; Classes of mathematical optimization methods, Sensitivity analysis, Special methods for optimization of energy systems, Environment considerations in the optimization of energy systems, Meta-heuristic techniques (genetic algorithms, particle swarm optimization).

ESL776 Industrial Energy and Environmental Analysis

3 Credits (3-0-0)

Pre-requisite(s): EC 75 (for UG Students in Minor Area)

Industrial energy use and its disaggregation (in terms of production dependent, weather dependent and independent etc. components), Energy intensity, Pinch analysis, Lean energy analysis, Thermodynamics and energy analysis, Life cycle energy analysis, Energy analysis and energy management, Energy audits, Managing energy efficiency in the industry. Basic approaches and tools for environment analysis, life cycle analysis and environmental impact assessment of industrial products and processes, Inventory of materials and energy inputs and environmental emissions, Emission factors, Relevant ISO standards (such as ISO 14040 and ISO 14044), Potential of energy and materials recovery, Case studies.

ESL778 Industrial Waste Management and Recycling

3 Credits (3-0-0)

Solid waste treatment and disposal. Sanitary Landfills. Leachate and gaseous emissions estimation from landfills. Energy resource recovery from waste, life cycle of waste materials, Waste management in different industries-steel, aluminium, chemical, paper, petroleum, and Petro-chemical. Waste water treatment techniques. Agricultural pollution. Application of air pollution control devices in industries.

ESL780 Zero Emission Vehicles

3 Credits (3-0-0)

Introduction to various zero emission vehicles; Fundamentals of Internal combustion (IC) engines (Spark ignition and Compression ignition engines); Emission and its formation mechanism (UHC, CO, NO_x, N₂O, PM etc.); Emission control strategies including EGR; Exhaust gas after treatment devices (TWC, SCR, LNT, DOC, DPF); Lean burn combustion (PCCI and HCCI): Controlled auto ignition, Homogeneous charge preparation strategies; Hydrogen fuelled vehicle: Back firing, Power drop, Fuel induction techniques; Battery operated vehicles: Introduction, Types, Batteries, Accessories; Hybrid vehicles: Introduction, Classification, Advantages and disadvantages; Fuel cell vehicles: Introduction, Fuel cell system, Classification, Speed-Torque and Speed-power characteristics, Operational issues; Well to wheel analysis of zero emission vehicles, Net impact (including embodied energy) of zero emission vehicles on Environment for assessment of CO₂ emission.

ESL782 Emission Control in Internal Combustion Engines

3 Credits (3-0-0)

Introduction to IC Engine Emissions; IC Engine's Regulated emissions (CO, HC, NO_x, PM and CO₂) and Greenhouse gas emissions (CO₂, CH₄, and N₂O), Transient emissions; Formation mechanism of these emissions (soot morphology, PM's size and count etc.) in IC Engines, Effect of combustion characteristics on emissions of IC engine, Effect of alternative and renewable fuels on emissions of IC

engine, Control strategies of emission at source level: Exhaust Gas Recirculation (EGR), Water injection, Use of gaseous fuels including hydrogen and natural gas, Control strategies for exhaust gas emissions with after-treatment devices: Catalytic control technologies, Oxidation Catalysts, Reduction catalysts, Three way Catalysts (TWC), Nonselective catalytic reduction (NSCR), Selective catalytic reduction (SCR), Diesel oxidation catalysts (DOC), Particulate emission control, Diesel particulate filter (DPF), Emission reduction of IC engine with renewable energy system under hybrid mode, National (Bharat Stage, CPCB etc.) and International (EPA, EURO etc.) Current and future national and international emission regulations of IC engines/ vehicles and emission testing procedures (ESC, ETC, 5-mode, 8-mode and 13 mode tests).

ESL784 Cogeneration and Energy Efficiency

3 Credits (3-0-0)

Pre-requisite(s): EC 75 (for UG Students in Minor Area)

The cogeneration concept, Main design parameters for cogeneration, Cogeneration alternatives, cogeneration efficiency, Steam turbine plants, Gas turbine plants, Spark ignition engine and compression ignition engine power plant, Combined cycle power plant, Sterling engine, Industry/Utility cogeneration, Tri-generation, poly-generation, Cogeneration in sugar, textile, paper and steel industry, Case studies.

ESL785 Energy Analysis

3 Credits (3-0-0)

Pre-requisite(s): EC 75 (for UG Students in Minor Area)

Energy theory of value: Principles and systems of energy flows, Methods of energy analysis, Energy intensity method, Process analysis input-output method based energy accounting, Energy cost of goods and services energy to produce fuels: Coal, Oil, Natural Gas, Energy to produce electricity, Energy cost of various modes of passenger & freight transportation, Industrial energy analysis: Aluminium, Steel, Cement, Fertilizers, Energetics of materials recycling, Energetics of renewable energy utilization (case studies), General energy equation, Energy loss, Reversibility & irreversibility, Pictorial representation of energy, Energy analysis of simple processes, Expansion, Compression, Mixing and separation, Heat transfer, Combustion, Energy analysis of thermal and chemical plants, Thermo economic applications of energy analysis and national energy balance.

ESL786 Exergy Analysis

3 Credits (3-0-0)

Pre-requisite(s): EC 75 (for UG Students in Minor Area)

Thermodynamic basis of available energy, exergy and entropy, Exergy balance equations for closed and open flow systems under steady state and unsteady state conditions, Exergetic efficiency definition for various devices, components including heat exchangers, mixing chamber and drying process, Exergy analysis of thermal energy systems including thermal power plants, refrigeration and heat pump/air-conditioning plants, Exergy analysis of solar energy systems, solar cooker/ dryer/ collector/ concentrator/ solar still/ solar pond/ thermal storage systems and solar thermal power generation, solar photo voltaic system, Economics based on exergy analysis of thermal energy systems.

ESL790 Policy and Regulatory Aspects of Power System Operation with Increasing Renewable Energy Share

3 Credits (3-0-0)

Overview of the global renewable energy sector, Role of various international energy organizations and government bodies, Country wise organizational structure for regulatory deployment of various schemes for RE integration at transmission and distribution level, Electricity Act of various countries and their comparison Overview of global solar energy policies, Regulatory Issues with the Deployment of Variable Renewable Energy Sources, Policy and regulatory Framework for rural electrification, Particular case studies for rural electrification in India/solar alliance countries, International Grid Codes, Amendments for renewable energy integration, Specific requirements for solar and wind integration, Comparative study of Indian grid code with

Nordic, European Network of Transmission System Operators for Electricity (ENTSO-E's) network codes and other country wise grid codes. Distribution system operator: countryside mechanism for DSO operations, EV scheduling, Demand side management. Time of Use (ToU)/Time of Demand (ToD) price regulation, factors influencing them.

ESL791 Renewable Energy Integration and Power Systems

3 Credits (3-0-0)

Integration of solar photovoltaic (PV) based and wind based generation systems to power system at different voltage levels, Integration of small- hydro, biomass gasifier based generations systems to LV distribution networks, Modelling of various types of storages in power systems, Power electronic based power flow controllers for transmission and distribution systems, Power flow analysis and State estimation, Security and Stability Analysis of renewable integrated transmission and distribution system, Optimal operational dispatch and Unit commitment, TSO-DSO Interaction, balancing, Congestion management, Ancillary services for frequency support, voltage support, balancing and inertial with different reserve types (battery, PV derating, Pumped storage, thermal, HVAC etc.)

ESL792 Advanced Energy Systems

3 Credits (3-0-0)

Latest topics on energy, Integrated Gasification Combined Cycle (IGCC), Fuels for power generation, Advanced Energy Storage Systems, Hydrogen Power, Clean Coal Technologies, Pressurized fluidized bed combustion, Natural gas cycles, Integrated generation, Fuel cells, Energy conservation in power plant, Battery vehicles, Electric vehicles, Algal biofuels, Metal hydrates, Geological CO₂ sequestering.

ESL796 Operation and Control of Electrical Energy Systems

3 Credits (3-0-0)

Real Time Monitoring of Power Systems: State Estimation, Topological observability Analysis, Security Analysis of Power Systems, Economic Dispatch & Unit Commitment.

Control of Power & Frequency: Turbine-Governor Control Loops, Single Area and Multi-Area Systems Control, Effect of high penetration of Wind & Other Renewable/Distributed Generation on P-F Control.

Control of Voltage & Reactive Power: Generator Excitation Systems, & Automatic Voltage Regulators, Transformer Tap Changes Controls, Voltage Control in Distribution Networks using New Power Electronic Devices.

Introduction to Market operations in Electric Power Systems: Restructured Power Systems, Short Term Load Forecasting, Power Trading through Bilateral, Multilateral Contracts and Power Exchanges, Role of Distributed Generators in market Operations.

ESL797 Operation of Electrical Energy Systems with Large Scale Integration of Renewable Energy Sources

4 Credits (3-0-2)

General structure of Indian power system, roles of various organizations like RLDCs, SLDCs, REMCs, ISO, CERC, SERC, GENCO, TRANSCO, DISCOs, RESCOs, in power supply chain. Challenges with large scale Integration of RE sources, Scheduling practices followed in Indian/International scenarios. Power flow analysis, State estimation, Optimal operational dispatch, Unit commitment, Demand side management, Security and stability analysis of integrated energy systems with high penetration of Renewable Energy Systems, DSO operations, Market mechanisms to buy/sell power, Balancing, Congestion management, Ancillary services for large scale integration of RE sources, Smart Grid/Micro grid operations.

ESL798 Distributed and Decentralized Energy Systems

3 Credits (3-0-0)

Operation and control of various distributed energy resources (DERs) such as roof top photovoltaic, wind, small hydro, fuel cell and battery energy storage systems, smart grid and distributed energy systems, inverter control, parallel operation of inverters in distributed energy resources (DERs), voltage and current control of a three phase four

wire distributed generator (DGs) inverters in islanded/grid connected modes. Operation and control of biogas and biodiesel based electricity generation systems. Distribution power flow, operational aspects of distribution systems with multiple DGs and energy storage. Multi generation frequency control, voltage and reactive power management in integrated systems with DGs and energy storage, stability analysis of DERs integrated energy systems, distribution system reconfiguration, effect of DERs on protection, operation and control of rural/urban/industrial micro grids.

ESL799 Essentials of Electrical Power Generation by Renewable Energy Sources

3 Credits (2-0-2)

Basics power electronic converters for renewable energy integration to power system, basics of wind power generation, wind turbines, generators (SCIG, DFIG, PMSG) and topologies, small hydro systems, control of wind power system, processing of solar power, power quality issues, power quality control, control of inverter output impedance, harmonic filters, control and protection issues with renewable solar/wind, parallel operation of inverters, power flow control, synchronverters, operation of inverters in islanded/grid connected modes, basic controllers for RE sources, PI, PID, intelligent controllers, synchronization techniques, conventional, PLL, sinusoid-locked loops, need for micro grids, architecture and communication infrastructure for smart grids, Importance and challenges for decentralized energy generation, peculiarities related to integration of roof top PV and autonomous energy storage devices. Basic requirement of PV inverters and source of leakage current

ESL804 Pollution Control in Power Plants

3 Credits (3-0-0)

Coal and nuclear based power plants-Fly ash generation, utilization, disposal and environmental impact; Nuclear fuel cycle; radioactive waste-treatment and disposal; Instrumentation; Pollution control methods-(i) Pre combustion control (ii) Combustion control during combustion clean coal technologies, advanced combustion control technologies (iii) Post-combustion Control; Gaseous pollutants control-Flue gas desulfurization (FGD) Systems, SO_x and NO_x treatments; Electrostatic precipitators; Thermal Pollution and its impact on aquatic life.

ESL810 MHD Power Generation

3 Credits (3-0-0)

Principle of MHD power generation, Properties of working fluids, MHD equation and types of MHD duct, Losses in MHD generators, Diagnostics of parameters, MHD cycles, MHD components (air heater, combustion chamber, heat exchanger, diffuser, insulating materials and electrode walls, magnetic field etc.), Economics and applications of MHD, Liquid metal MHD generators.

ESL840 Solar Architecture

3 Credits (3-0-0)

Thermal comfort, sun motion, Building orientation and design, passive heating and cooling concepts, thumb rules, heat transfer in buildings: Thermal modeling of passive concepts, Evaporative cooling, Energy efficient windows and day lighting, Earth air tunnel and heat exchanger, Zero energy building concept and rating systems, Energy conservation building codes, Software for Building Simulation, Automation and Energy Management of Buildings.

ESL842 Negative CO₂ Emission Technologies

3 Credits (3-0-0)

Introduction to Negative Emissions; Paris climate summit on limiting average global temperature rise; Future projected concentration of Carbon dioxide (CO₂) in atmosphere and consequences of Climate change and global warming; Carbon budget; Overview of CO₂ emission from industrial sectors, transport sectors, power generating sectors; formation mechanism of CO₂ emission in combustion engines; Radiative forcing of climate change; Global warming potential (GWP); Stabilization of CO₂ emission in the atmosphere by renewable energy systems; Renewable energy system with carbon sequestration technologies.

Different methods/technologies of Carbon dioxide removal from the atmosphere: Ocean Liming; Enhanced Weathering; Ocean Fertilization; Forestation; Soil Carbon Management; Direct Air Capture; Artificial trees; Bioenergy with Carbon Capture & Storage; Pyrolysis process and Biochar; CO₂ emission reduction through Energy efficiency improvement in energy devices/power plants; Integration of different renewable energy systems (solar photovoltaic, solar thermal, wind, bioenergy, geothermal, tidal) with the carbon sequestration technologies; Analysis of energy intensity of carbon dioxide removal system; Different scenario of CO₂ emission reduction; Exploration of possible Sequestration of CO₂ at source level in industries; Issues and control measures of CO₂ removal system; Carbon tax and credit; Case studies.

ESL845 Net Zero Energy Buildings

3 Credits (3-0-0)

Introduction to Net Zero Energy Buildings (NZEBs) and its Concepts; Different Definitions of NZEBs; Relevance of Such Systems; Steps to Achieve NZEBs; Challenges Involved in the Design of Such Systems, Sources of Renewable Power for NZEBs; Thermal Loads and Energy Use in Buildings; Design Considerations in NZEBs: Building fabric/envelope, HVAC and Lighting Systems, Integration with Solar/Renewable Energy Systems, Building Management Systems; Optimal resource dispatch (thermal and electrical), demand side management with NZEB operation including HVAC, lighting control Operation of building microgrids in grid connected/islanded modes, provision of ancillary services or peer to peer sharing among the various buildings Comfort considerations in NZEBs: Thermal Comfort, Visual Comfort, Acoustic Comfort, Indoor Air Quality; Carbon Footprint Mitigation; NZEB Case Studies, Future Directions.

ESL850 Solar Refrigeration and Air Conditioning

3 Credits (3-0-0)

Potential and scope of solar cooling, Types of solar cooling systems, Solar collectors and storage systems for solar refrigeration and air-conditioning, Solar operation of vapour absorption and vapour compression refrigeration cycles and their thermodynamic assessment, Rankine cycle, sterling cycle based solar cooling systems, Jet ejector solar cooling systems, Fuel assisted solar cooling systems, Solar desiccant cooling systems, Open cycle absorption / desorption solar cooling alternatives, Advanced solar cooling systems, Thermal modeling and computer simulation for continuous and intermittent solar refrigeration and air-conditioning systems, Refrigerant storage for solar absorption cooling systems, Solar thermoelectric refrigeration and air-conditioning, Solar thermo acoustic cooling and hybrid airconditioning, Solar economics of cooling systems.

ESL852 Emerging Materials for Next Generation Photovoltaic Applications

3 Credits (3-0-0)

Wide range of non-conventional emerging materials for next generation photovoltaic applications will be discussed in detail. In the first part, fundamental photo-physics of different materials such as organic, inorganic and hydride semiconductors, comparison of their specific optical and electrical properties and basic characterisations for solar cells will be introduced. The second part will be dedicated for new emerging materials such as, Organic semiconductors, hybrid perovskite, metal chalcogenides and ferroelectrics for PV application. Their fundamental properties, technologies and device applications will be discussed in details. In the next part, carbon based nano-materials and quantum dot based highly efficient devices will be discussed. In the last part various technologies and material processing for the production of low-cost Si cell and their recycling processes will be emphasized.

ESL855 Solar Photovoltaic Power Generation

3 Credits (3-0-0)

Components of Photovoltaic Power Generation with Cost-Breakup (Present and Projected). Various kinds of PV modules and their features, IV-Characteristics and Electrical Equivalent Circuits under various conditions. Effect of partial shading, Local and global MPPT. Mounting structures and earthing for various kind of Solar PV plants.

Cables and cable-layout, maintenance and standards for various kind of Solar PV plants. MPPT algorithms and tuning parameters. Review of basic power electronics and control systems. Charge controllers and Inverter configurations. Off-grid power converter configurations and operation (features). Grid connected central inverter: Configuration, performance and features. Synchronization and other control requirements for grid connected power converters. Leakage current and transformer-less power converters. Transformers for utility scale solar PV power plants. Power quality and related standards. Power Purchase agreements. Emerging trends for PV power generation: Converter topology, Ancillary support and SCADA

ESL860 Electrical Power Systems Analysis

3 Credits (3-0-0)

Network modeling and short circuit analysis: Primitive network, Y bus and Z bus matrices formulation, Power invariant transformations, Mutually coupled branches Z bus, Fault calculations using Z bus, Power flow solutions: AC load flow formulations, Gauss-siedel method, Newton Raphson method, Decoupled power flow method, Security analysis: Z bus methods in contingency analysis, Adding and removing multiple lines, Interconnected systems, Single contingency and multiple contingencies, Analysis by DC model, System reduction for contingency studies, State Estimation: Lone power flow state estimator, Method of least squares, Statistics error and estimates, Test for bad data, Monitoring the power system, Determination of variance, Improving state estimates by adding measurements, Hierarchical state estimation, Dynamic state estimation, Power system stability: transient and dynamic stability, Swing equation, Electric power relations, Concepts in transient stability, Method for stability assessment, Improving system stability.

ESL870 Fusion Energy

3 Credits (3-0-0)

Fission and fusion, Need for plasma, Lawson criterion, Confinement problem, Laser driven fusion, Magnetic confinement, Plasma concept, Single particle motions in complex magnetic field geometries, Equilibrium and stability, Cross field transport, Important heating schemes, Tokamak and magnetic mirror, Reactor concepts, Current status.

ESL871 Advanced Fusion Energy

3 Credits (3-0-0)

Tokamak confinement Physics, Particle motions in a tokamak, Toroidal equilibrium, Toroidal stability, High-beta Tokamak, Experimental observations, Fusion Technology, Commercial Tokamak Fusion-power plant, Tandem-mirror fusion power plant, Other Fusion reactors concepts, Inertial confinement fusion reactors, Reactor cavity, Hybrid fusion/fission systems, Process heat and synthetic fuel production.

ESL875 Alternative Fuels for Transportation

3 Credits (3-0-0)

Pre-requisite(s): EC 100 (for UG Students in Minor Area)

An introduction to hydrocarbon fuels-their availability and effect on environment, Resources such as shale gas and petroleum, Gasoline and Diesel self-ignition characteristics of the fuel, octane number, Cetane number, Alternative fuels -liquid and gaseous fuels, Physico-chemical characteristics, Alternative liquid fuels, Alcohol fuels -ethanol and methanol, fuel composition, Fuel induction techniques, Fumigation, Emission of oxygenates, Applications to engines and automotive conversions, Biodiesel formulation techniques, Transesterification, Application in diesel engines, Dimethyl ether(DME), properties fuel injection consideration general introduction to Liquefied Petroleum Gas(LPG) and Liquefied Natural Gas(LNG), Compressed natural gas (CNG) components, mixtures and kits, Fuel supply system and emission studies and control, Hydrogen combustion characteristics, Flashback control techniques, Safety aspects and system development, NOx emission control, Biogas, Producer gas and their characteristics, System development for engine application.

ESL880 Solar Thermal Power Generation

3 Credits (3-0-0)

Relevance of solar thermal power generation; Design and performance

characteristics of different solar concentrator types suitable for thermal power generation; Tracking of solar concentrators; performance characterization of solar concentrators, Storage option for solar thermal power plants; Modes of power generation in solar thermal power plants; Sizing solar thermal power plants; Operation and maintenance issues; Emerging trends in solar thermal power generation; Economics of solar thermal power generation; Case studies.

ESL885 Solar Industrial Process Heating

3 Credits (3-0-0)

Basics of Solar Radiation, classification of solar thermal energy systems, Non-Concentrating solar collectors: Flat plate and evacuated tubular solar collector, Concentrating solar collectors: Compound parabolic concentrator, parabolic trough collector, linear Fresnel collector, parabolic dish collector, Optics of solar collectors, Tracking systems solar concentrators, receivers for concentrators; Designing thermal storage for industrial application; Applications of solar thermal energy system for various industrial applications such as pulp and paper, textile, oil upstream and downstream, food and beverage, pharmaceutical, leather, automobile industries, etc. Basics of economics.

ESN702 Introduction to Project Management

0 Credits (1-0-0) / Bridge Audit (for students in ESR programme)

Project initiation and planning, Site and technology selection, Regulatory, permitting and environmental compliance, Project feasibility assessment, Identification and mitigation of risks, Planning execution as well as monitoring of projects, Operation and maintenance of projects.

ESN703 Technical Writing

0 Credits (1-0-0) / Bridge Audit (for students in ESR programme)

Language and Communication skills, Basic ethics and styles of Scientific/Technical document writing, Referencing in proper format, Planning Design and Layout of presentation, Important technical jargon for Energy Engineers.

ESN704 Basic Thermal Engineering

0 Credit (1-0-0) Compulsory Audit (for students in ESN programme) / Bridge Audit (for students in ESR programme) (For Non-Mechanical students in ESN programme)

First and second law of thermodynamics, Thermal fluid systems, Standard cycles, Mixture of gases, Heat Transfer, Fluid Mechanics, Practical Examples, Use of steam tables.

ESN712 Basic Electrical Engineering

0 Credit (1-0-0) Compulsory Audit (for students in ESN programme) / Bridge Audit (for students in ESR programme)

Power circuits and electrical machinery, AC circuit analysis, Three-phase circuits, Power circuits components and energy conservation devices, Variable speed drives, Demand controls.

ESN791 Applied Mathematics and Computational Methods

0 Credit (1-0-0) / Bridge Audit (for students in ESR programme)

Fourier and Laplace transform, Complex and vector analysis, Matrices, Numerical and computational methods, Finite difference, Numerical methods of integration, Least square curve fitting, Introduction to C++ and MATLAB

ESP705 Renewable Energy Laboratory

3 Credits (0-0-6)

The main focus of this laboratory is to provide exposure and hands-on-skills practice to the students on various aspects of renewable energy sources and technology. The students would be able to get detailed insights into the design and operational aspects of renewable energy devices and systems.

ESP706 Renewable Energy Simulation Laboratory

3 Credits (0-0-6)

Simulation experiments related to Renewable Energy Systems.

ESP713 Energy Laboratories

3 Credits (0-0-6)

Pre-requisite(s): EC 75 (for UG Students in Minor Area)

ESP728 Energy and Environment Laboratory

3 Credits (0-0-6)

ESV891 Special Topics on Emerging Trends in Energy and Environmental Technologies

1 Credit (1-0-0)

ESD798 Minor Project (ESR)

3 Credits (0-0-6)

As per field of research required in the project in the area of Renewable Energy Technologies and Management.

ESD799 Minor Project (ESN)

3 Credits (0-0-6)

As per field of research required in the project in the area of Energy & Environment Technologies and Management.

ESD801 Major Project Part - 1 (ESN)

6 Credits (0-0-12)

As per field of research required in the project in the area of Energy & Environment Technologies and Management.

ESD802 Major Project Part - 2 (ESN)

12 Credits (0-0-24)

As per field of research required in the project in the area of Energy & Environment Technologies and Management.

ESD851 Major Project Part - I (ESR)

6 Credits (0-0-12)

As per field of research required in the project in the area of Renewable Energy Technologies and Management.

ESD852 Major Project Part - II (ESR)

12 Credits (0-0-24)

As per field of research required in the project in the area of Renewable Energy Technologies and Management.

ESS801 Independent Study (ESN)

3 Credits (0-3-0)

As per field of research required in the project in the area of Energy & Environment Technologies and Management.

ESS851 Independent Study (ESR)

3 Credits (0-3-0)

As per field of research required in the project in the area of Renewable Energy Technologies and Management.

JSD799 Minor Project (JES)

3 Credits (0-0-6)

JSD801 Major Project Part - 1 (JES)

6 Credits (0-0-12)

JSD802 Major Project Part - 2 (JES)

12 Credits (0-0-24)

JSS801 Independent Study (JES)

3 Credits (0-3-0)

Department of Humanities and Social Sciences

HUL101 English in Practice

3 Credits (2-0-2)

Verb structures and patterns, avoiding common errors, vocabulary building, spelling patterns, developing writing skills (composition, letter writing) etc. developing listening skills.

HUP102 Psychology Laboratory

1 Credit (0-0-2)

To familiarize students with psychological concepts through practical training in a laboratory through experiments pertaining to cognitive psychology, environmental psychology and physiological psychology.

HUL211 Introduction to Economics

4 Credits (3-1-0)

Pre-requisite(s): NLN101

Current economic problems. Alternative economic systems. An overview of the economy. The market mechanism. National product and income. Consumption, savings and investment. Determination of national income. Aggregate demand and supply. Fiscal policy. The nature of money and monetary policy. Inflation and unemployment. Basic concepts of price theory. Determination of price by supply and demand. Elasticity of demand and supply. Theory of production. Theory of costs. Pricing in competitive and monopoly markets. The gains from international trade. Theory of exchange rates. Balance of payments. Economic growth, and development. Inequality and poverty.

HUL212 Microeconomics

4 Credits (3-1-0)

Pre-requisite(s): NLN101

Micro versus macroeconomics. Theory of consumer behavior and demand. Consumer preferences. Indifference curve. Consumer equilibrium. Demand function. Income and substitution effects. The Slutsky equation. Market demand. Elasticities. Average and marginal revenue. Revealed preference theory of firm. Production functions. Law of variable proportions. Laws of return to scale. Isoquants. Input substitution. Equilibrium of the firm. Expansion path. Cost function. Theory of costs. Short Run and Long run costs. Shape of LAC. Economies and diseconomies of scale. Market equilibrium under perfect competition. Equilibrium under alternative forms of market. Monopoly: pure and discriminating. Monopolistic competition. Oligopoly.

HUL213 Macroeconomics

4 Credits (3-1-0)

Pre-requisite(s): NLN101

Major economic problems. National income accounting. Expenditure and income approaches to GNP. Measuring inflation and unemployment. Determination of the equilibrium level of income. Consumption function. Investment demand. Aggregate demand and equilibrium output. The multiplier process. Government sector. Fiscal policy. Tax receipts and Transfer payments. Foreign spending. Money, interest and income. Functions of money. Definition of money. Reserve Bank of India and Commercial Banks. Creation of money. The instruments of monetary control. The demand for money. Investment expenditure and rate of interest. The IS curve. Money market and the LM curve. Liquidity trap. The IS-LM model. Derivation of the aggregate demand curve. Monetary and fiscal policies. Keynesian versus monetarist views. The aggregate supply function: Keynesian and classical. Inflation and unemployment. Stagflation. The Phillips curve. The long-run Phillips curve. Inflation expectations. The rational expectations.

HUL217 History of Economic Thought

4 Credits (3-1-0)

This course will introduce ideas in the history of economic thought, from mercantilism, socialism, communism, capitalism to the rise of modern economic theory (e.g. utilitarianism), along with questions about economic theory (especially from behavioural sciences).

HUL232 Modern Indian Fiction in Translation

4 Credits (3-1-0)

Pre-requisite(s): NLN101

Students would be introduced to the conditions, beginning in 19th century colonial rule in India, which led to the emergent Indian middle-class intelligentsia to experiment with European forms of literature but striving for an alternative expression. Indian languages became the medium through which writers sought to address issues of identity, tradition, gender, the rural and the urban, the private and the public. The course will study the various experiments in narration, language, characterization and style undertaken by authors to shape these themes.

HUL235 Rise of the Novel

4 Credits (3-1-0)

Pre-requisite(s): NLN101

The socio-political contexts which lead to the rise of the novel in Europe – the emergence of print, the expansion of literacy, and the establishment of capitalism. Close reading of selected texts accompanying concepts like the rise of the modern individual, varied narrative techniques and national consciousness. The emerging sub-genres of the novel – the comic, the picaresque, the historical novel and the realist novel. The linkage of the novel to the colonial project and its influence on world literature.

HUL236 Introduction to Drama

4 Credits (3-1-0)

Pre-requisite(s): NLN101

Brief history of the development and importance of drama in Western and Indian contexts. Readings from both ancient and contemporary drama theorists. Generic differences between different forms of drama such as tragedy, comedy, realist, 'folk', Absurd, etc. Detailed study of important examples of different forms of drama.

HUL237 Contemporary Fiction

4 Credits (3-1-0)

Pre-requisite(s): NLN101

- Approaches to contemporary fiction - Looking at contemporary styles - realism, modernism, postmodernism - Contemporary versions of classical genres - the diary, epistolary form, epic, etc. - the relationship of society with science and technology through fiction - the relationship between self and society through fiction - Race, nationality, culture and identity - contemporary forms.

HUL239 Indian fiction In English

4 Credits (3-1-0)

Pre-requisite(s): NLN101

The course involves a detailed study of 3-4 texts corresponding to the distinct phases of literary activity in the genre: the early period of the 1940s and 50s in which writers like Mulk Raj Anand, Raja Rao and R.K. Narayan made their presence felt, before Salman Rushdie, and more quietly, Amitav Ghosh and Vikram Seth, erupted into the scene in the 1980s, spawning a generation of writers attaining international acclaim - Arundhati Roy, Aravind Adiga, Kiran Desai, and many others. Some of the questions that will be addressed are: Who constitutes the main audience for this writing, and (how) does the writing cater to it? How does one position the expatriate Indian writer both residing and publishing abroad? How does English become an Indian language? Is there a thematic congruence in the novels that fall under this category, and does it differ from the thematic concerns of novels written in other Indian languages? Students will be encouraged to read a novel in at least one other Indian language in order to allow them to pose these questions in a more pointed manner.

HUL240 Indian English Poetry

4 Credits (3-1-0)

Pre-requisite(s): NLN101

The aim of this course will be to read the poems of Indian English

Writers (pre and post-Independence), with specific reference to the articulation of their identity. Some of the perspectives from which the poems will be discussed include the notion of home (childhood, family and ancestors); land (history, geography, community, caste and contemporary politics); language (the dialogue between the different languages in the creative repertoire of the poets); and culture (ritual, traditions, legends and myths). The course will also look at the differences between the resident and expatriate poets vis-a-vis the conflicts and resolutions as expressed in their poems.

HUL242 Fundamentals of language sciences

4 Credits (3-1-0)

Pre-requisite(s): NLN101

This course provides answers to basic questions about the nature and constitution of human language in the mind/brain of native speakers. Varied aspects of linguistic organization, including structures of sounds, words and sentences are considered to understand the core universals of all languages as well as their variations. Cases of feral children, language deficiencies and cognition-language interactions are also highlighted.

HUL243 Language and Communication

4 Credits (3-1-0)

Pre-requisite(s): NLN101

This course offers a wide-ranging introduction to, and analysis of, varieties of spoken and written language. From political oratory to examination answer scripts to computer codes, not to mention jokes, riddles and poetry, human language offers an amazingly rich set of structures for expressing and conveying our thoughts, intentions and desires. The course will consider some of these linguistic structures and communicative strategies in detail, beginning with early childhood development. How is it that children in every culture learn language so effortlessly despite its great complexity? The course aims to introduce students to a set of theories that address this and other puzzles and mysteries in the arena of language studies. Finally, since a central focus of the course is communication, it will strive to be as interactive as possible, with lots of scope for the discussion and working out of actual 'problems' in language use.

HUL251 Introduction to Logic

4 Credits (3-1-0)

In this course, students are introduced to fundamentals of informal logic and verbal analysis, material and formal fallacies of reasoning often found in ordinary discourse, deductive and Inductive reasoning, validity and soundness, formal rules and principles of the deductive system of Aristotelian logic, traditional square of opposition; propositional calculus; first order predicate calculus; the modern square of opposition and the problem of existential import; identity and definite descriptions; methods for formulating natural language arguments in symbolic forms and techniques for checking their validity; various meta-logical theorems and their proofs.

HUL253 Moral Literacy and Moral choices

4 Credits (3-1-0)

Pre-requisite(s): NLN101

This is primarily a course in applied ethics. It will focus primarily on questions like: What is the meaning of right action? Can ethical assertions be true or false? Is morality relative to society? Or can we say that acts have universal moral content? The course discussions will help to demonstrate that morality is not always self-evident and that rational morality must come in place of taboo based moralities.

HUL256 Critical Thinking

4 Credits (3-1-0)

Pre-requisite(s): NLN101

What makes philosophical thinking radically critical? Investigation of the nature of knowledge about the world and justification of knowledge claims. Metaphysical understanding of the Absolute

and Mind-Body relation. The nature of ethical and aesthetic beliefs and attitudes as part of understanding the nature of values. The discussion of the above issues will be influenced by three philosophical orientational perspectives: Anglo-American Analytic, Continental Phenomenological and Classical Indian.

HUL258 Social and Political Philosophy

4 Credits (3-1-0)

Pre-requisite(s): NLN101

As closely aligned areas in philosophy– social philosophy with the role of individual in society and political philosophy with the role of government- this course bridges divides between social theory, political philosophy, and the history of social and political thought as also between empirical and normative analysis through perspectives from metaphysics, epistemology and axiology. A range of socio-political thinkers, theories and concepts will be taught. It will provide a broad survey of fundamental social and political questions in current contexts discussing philosophical issues central to political thought and radical critiques of current political theories.

HUL261 Introduction to Psychology

4 Credits (3-1-0)

Pre-requisite(s): NLN101

Psychological Science- Assumptions, schools, methods of doing psychology research, The relationship between brain, body and mental functioning, Sensation, perception and making sense of the world, Consciousness, Life span development and motor and language development, Nature and nurture controversy, The learning process and some important explanations of how we learn, Meaning of motivation and explanations, Theories of emotions and expression and regulation of emotions, Basic cognitive processes, Language development, why we remember and why we forget- some explanations, Different kinds of intelligence, explanations of creativity, Differences among individuals and explanations for personality differences, Application of psychology to everyday life- enhancing health and well-being, performance, social relations, and sensitivity to environmental, social and cultural contexts.

HSL262 Social Psychological Approaches to Health & Wellbeing

4 Credits (3-1-0)

The courses will focus on the following: Introduction: Social Psychology and Health & Wellbeing, Groups, Social identity and Health: An emerging perspective, Stress and Coping, Stigma and wellbeing, Effects of Discrimination, violence and intractable conflicts, Depression, Emotions and Health: Effects of Shame and Humiliation, Collective Participation and Wellbeing, Building individual and collective resilience.

HUL265 Theories of Personality

4 Credits (3-1-0)

Pre-requisite(s): NLN101

Personality: Meaning & Assessment. Psychoanalytic & Neo-Psychoanalytic Approach ; Behavioural Approach; Cognitive Approach; Social- Cognitive Approach; Humanistic Approach; The Traits Approach; Models of healthy personality: the notion of the mature person, the self-actualizing personality etc. Personality disorders; Psychotherapeutic techniques and Yoga & Meditation; Indian perspective on personality; Personality in Socio- cultural context.

HUL267 Positive Psychology

4 Credits (3-1-0)

Pre-requisite(s): NLN101

Positive Psychology: A historical and contextual overview; Relationship between Indian Psychology and Positive Psychology; Correlates and predictors of life satisfaction and subjective well-being across various cultures; Latest researches on self-esteem, optimism, flow, post-traumatic growth, positive ageing, character strengths, etc.; Major

theories and models within positive psychology – Self-Determination theory, Broaden-and-Build theory, Authentic Happiness, Psychological Well-being, etc., Interpersonal character strengths & well-being; Specific Coping Approaches: meditation, yoga and spirituality; Future of the Field.

HUL271 Introduction to Sociology

4 Credits (3-1-0)

Pre-requisite(s): NLN101

Introduction to the discipline of sociology and its emergence as a science in the context of the development of modern industrial society in Europe. Introduction to key classical and contemporary theorists in Sociology.

HUL272 Introduction to Sociology of India

4 Credits (3-1-0)

Pre-requisite(s): NLN101

This course will begin with a discussion on the various constructions of Indian society from colonial to contemporary times. The structural and cultural dimensions of Indian society are explored at the level of village, city, region, nation and civilization. Sources of differentiation, diversity and unity are explored through institutions such as caste, class and tribe; kinship, family, marriage and gender systems, religious traditions and political organisations. Transformations in these institutions are analysed and fault lines explored by studying contemporary issues of secularism, communalism, religious conversions, caste and identity movements. The sociological perspective remains key to interpreting changes in Indian society in the era of globalization and rapid economic change.

HUL274 Re-thinking the Indian Tradition

4 Credits (3-1-0)

Pre-requisite(s): NLN101

The examination of sources, the structure, the texts and exemplars of the Indian tradition provide the theoretical framework for the discussion of contemporary political and social issues. These are economic development and social justice religion and the nation, communalism and secularism, caste class and gender equity and so on. The political misuse of tradition in programs of reform and revival both in the past and in modern times will be highlighted to underline the need for rethinking tradition in an academically serious manner.

HUL275 Environment, Development and Society

4 Credits (3-1-0)

Pre-requisite(s): NLN101

Students will be exposed to contemporary themes and debates on connection between environment, development, and society; industrialization and risk society; challenge of sustainable development; perception of the environment, dependence for livelihood, identity, and power on natural resources; social ecology; what is the role of religion in determining our world view and relation with the environment?; recognition of indigenous knowledge; rise of environmental movements, development projects and recent conflict over natural resources; understanding major environmental disasters and industrial accidents; global climate change negotiations; gender and environment.

HUL276 Sociology of Knowledge

4 Credits (3-1-0)

Pre-requisite(s): NLN101

The de-mystification of science as a privileged form of knowledge since Copernicus. Re-examining the laboratory, the factory and the nation-state, structures linked to the West-European model of science. Examining systems deemed ethno-science or folk-lore, to set up a dialogue with institutionalized science. Comparing science with religion as forms of knowledge having competing power over human belief and action. Examining Traditional Knowledge (TK) systems and their relevance for global economy.

HUL281 Technology and Governance

4 Credits (3-1-0)

Pre-requisite(s): NLN101

The course will begin with theories and concepts on the use of technologies to improve governance such as efficiency, transparency, empowerment, economic gains, decentralization etc. It will discuss the concepts of democracy and governance, corruption and accountability. Examples and case studies from topics such as information and communication technologies for development, electronic governance, electronic voting, electronic databases (UID), web portals, community radio etc. Public-private partnerships, regulation of technology by the state, surveillance, and the role of stakeholders in the policy making process.

HUL282 System and Structure: An Introduction to Communication Theory

4 Credits (3-1-0)

Pre-requisite(s): NLN101

This course is an introduction to theories of communication for which there is not sufficient time in the other communication courses, which are mainly applied in their orientation. This is an interdisciplinary course. It will examine how the notion of communication is used in different disciplines in the humanities and the social sciences. It will intersect with problems of organizational structure, linguistic structure, interpersonal structure and the problem of what is involved in changing a structure. This course will include no components of remedial English, business correspondence or skill building activities. Only those really interested in theoretical questions should enroll.

HUL286 Social Science Approaches to Development

4 Credits (3-1-0)

Pre-requisite(s): NLN101

Distinction between 'growth' and 'development'; historical genesis and evolution of the concept of development; theories of development and underdevelopment; the political nature of the development process. Role of state, market, culture and civil society in development. Gendered nature of development. Post-independence Indian experience (centralized planning and socialism) of development; selected comparisons with China, East Asia, South Asia, Africa, Latin America. Explaining India's slow progress in human and social development, poor record in reduction of poverty and inequality. Impact of globalization, foreign aid and economic reform on India's development. Experiments with decentralization and sustainable development.

HUL289 Science, Technology and Human Development

4 Credits (3-1-0)

Pre-requisite(s): NLN101

The course will begin by identifying various dimensions of human development and mapping the state of India and the world on these indicators. It will then discuss theories about how science and technology (S&T) have shaped human development historically and the dynamics of technological change. Relationship between innovation and human development will be discussed using examples from the appropriate technology movement, health, education, nutrition, energy, environment, and others. Gender dimensions of S&T, indigenous knowledge, and radical critiques of S&T will be discussed.

HUL290 Technology and Culture

4 Credits (3-1-0)

Pre-requisite(s): NLN101

To examine the relationship between technology and culture through a consideration of modern/current developments in various specific areas: e.g. Biotechnology and Medicine, IT, AI & Robotics, Fashion Technology, Magic Technology, Communications, Defense and Space Research. To focus on the roles played by the IITs themselves in creating 'knowledge societies' - that is, in influencing, formulating and envisioning the links between technological 'solutions' and socio-cultural 'problems' especially in the Indian context. Here we

will discuss, for example: Patent Laws, Gender Issues, Environmental Ethics, Design(er) and Person(al) Technological Aesthetics, Technologies for the Disabled, Educational Technologies.

HUL310 Selected Topics in Policy Studies

3 Credits (3-0-0)

Pre-requisite(s): Any Two courses from HUL2XX category

Allocation Preferences : HUL281, HUL289, HUL290

The course will introduce students to selected topics in Policy Studies as decided by the instructor.

HUL311 Applied Game Theory

3 Credits (3-0-0)

Pre-requisite(s): Any Two courses from HUL2XX category

Allocation Preferences : HUL211, HUL212, HUL213

This module introduces students in economics and other social sciences to game theory, a theory of interactive decision making. This module provides students with the basic solution concepts for different types of non-cooperative games, including static and dynamic games under complete and incomplete information. The basic solution concepts that this module covers are Nash equilibrium, subgame perfect equilibrium, Bayesian equilibrium, and perfect Bayesian equilibrium. This module emphasizes the applications of game theory to economics, such as duopolies, bargaining, and auctions.

HUL312 Distribution and Growth

3 Credits (3-0-0)

Pre-requisite(s): Any Two courses from HUL2XX category

Allocation Preferences : HUL211, HUL212, HUL213

Though empirical questions are central in motivating the issues on distribution, this course will mostly draw from theory. Papers published in established journals will cover the major references for this course. It will start from some empirical pattern of development (Kuznet's hypothesis), country experiences, etc. to motivate the subject. Then it will try to understand the process of distribution, growth and structural change using standard macroeconomic models. This course will be heavily dependent on Mathematics - mainly calculus.

HUL314 International Economics

3 Credits (3-0-0)

Pre-requisite(s): Any Two courses from HUL2XX category

Allocation Preferences : HUL211, HUL212, HUL213

Basic concepts of national income accounting, money, and balance of payments; output and exchange-rate determination under fixed and flexible exchange-rate regimes; fiscal and monetary policies in an open economy; international capital movements and their impacts; Case Studies: East Asian crisis, global financial crisis; theories of international trade including factor-proportions and economies of scale; the international trading regime and its implications for developing countries.

HUL315 Econometric Methods

3 Credits (3-0-0)

Pre-requisite(s): Any Two courses from HUL2XX category

Allocation Preferences : HUL211, HUL212, HUL213

Basics of sample survey; variance and covariance; correlation coefficient; simple regression analysis; Gauss-Markov theorem; estimation of regression coefficients; confidence intervals and hypothesis testing in regression analysis; type-I and type-II errors; transformation of variables; multiple regression analysis; multicollinearity, heteroscedasticity, dummy variables, basics of time-series analysis.

HUL316 Indian Economic Problems and Policies

3 Credits (3-0-0)

Pre-requisite(s): Any Two courses from HUL2XX category

Allocation Preferences : HUL211, HUL212, HUL213

The course is aimed at developing an understanding of the economic issues in a range of economic activities in the Indian economy. The themes that can be covered include performance of the Indian Economy since 1951, agricultural growth in India, inter-regional variation in growth of output and productivity, farm price policy, recent trends in industrial growth, industrial and licensing policy, policy changes for industrial growth, economic reforms and liberalization, population growth, unemployment, food and nutrition security, and education. It will also include some contemporary issues.

HUL318 Public Finance and Public Economics

3 Credits (3-0-0)

Pre-requisite(s): Any Two courses from HUL2XX category

Allocation Preferences : HUL211, HUL212, HUL213

The course is aimed at developing an understanding of the basics in Public Economics and Public Finance. Public economics is the study of government policy from the points of view of economic efficiency and equity. The course deals with the nature of government intervention and its implications for allocation, distribution and stabilization. Inherently, this study involves a formal analysis of government taxation and expenditures. The subject encompasses a host of topics including public goods, market failures and externalities. The course is divided into two sections, one dealing with the theory of public economics and the other with the Indian public finances.

HUL320 Selected Topics in Economics

3 Credits (3-0-0)

Pre-requisite(s): Any Two courses from HUL2XX category

Allocation Preferences : HUL211, HUL212, HUL213

The course will introduce students to selected topics in Economics as decided by the instructor.

HUL331 Modernist Fiction

3 Credits (3-0-0)

Pre-requisite(s): Any Two courses from HUL2XX category

Allocation Preferences : HUL231, HUL232, HUL235, HUL236, HUL237, HUL240, HUL239

The course will undertake a detailed study of some of the most iconic Modernist novels by writers such as Virginia Woolf, James Joyce, Franz Kafka and Samuel Beckett. It will examine the radical new ways in which they grappled with language, turned towards interiority, and pushed, in the process, narrative art to its very limits. The discussion will highlight the experimental quality of Modernist literature, as well as situate it within the context of its emergence - the two world wars, the development of psychoanalysis, the growth of metropolitan cities, and scientific and technological advancements.

HUL332 Fantasy Literature

3 Credits (3-0-0)

Pre-requisite(s): Any Two courses from HUL2XX category

Allocation Preferences : HUL231, HUL232, HUL235, HUL236, HUL237, HUL240, HUL239

Major Themes of Fantasy: Archetypes and Myths; Motifs - journeys, theology, devices and aides; creation of alternate worlds; treatment of time and space; close readings of individual texts.

HUL333 Theatre of the absurd

3 Credits (3-0-0)

Pre-requisite(s): Any Two courses from HUL2XX category

Allocation Preferences : HUL231, HUL232, HUL235, HUL236, HUL237, HUL240, HUL239

Socio-political background of the theatre of the Absurd, its basis in Existentialist philosophy. The reactions against the conventions of realist theater that dominated this theatre. The pre-occupations of major playwrights with issues of language and the difficulty of communication, the isolation that human beings tend to feel from each other and themes of violence.

HUL334 From Text to Film

3 Credits (3-0-0)

*Pre-requisite(s): Any Two courses from HUL2XX category**Allocation Preferences : HUL231, HUL232, HUL235, HUL236, HUL237, HUL240, HUL239*

The course will involve a detailed study of 3-4 texts and their corresponding adaptations into film. By means of close reading, analysis, and discussion, it will seek to identify the changes that take place during the process of adapting one art-form into another and ask why those modifications occur. An evaluation of what each art-form enables and what it restricts or denies will enable a better understanding of form per se, and of these two forms in particular. Further, the course will address the question of genre and its conventions especially with regard to film, and observe the extent to which generic expectations shape the process of adaptation of text into film. Film screenings will be held outside class hours in the evenings.

HUL335 Indian Theatre

3 Credits (3-0-0)

*Pre-requisite(s): Any Two courses from HUL2XX category**Allocation Preferences : HUL231, HUL232, HUL235, HUL236, HUL237, HUL240, HUL239*

This course will study the various aspects of Indian theatre. The linkages between ancient theatre forms and existing forms of indigenous performance in various parts of India – such as the nautanki, the tamasha and the jatra. The energies which were generated in the urban centres through the encounter with European drama – the Parsi theatre, the nascent Marathi stage, the Hindi theatre of Bhartendu Harishchandra and the nationalist theatre of Calcutta – will be explored. Special attention would be paid to the transformation of theatre values with the intervention of the Indian People's Theatre Association (IPTA). The focus for the post-Independence period would be on the diverse energies of urban theatre, group theatre and the 'back to the roots' movement. The course would require students to study play-scripts as well as look at accompanying literature to form a concrete idea of the philosophy behind Indian theatrical practice.

HUL336 Workshop in Creative Writing

3 Credits (3-0-0)

*Pre-requisite(s): Any Two courses from HUL2XX category**Allocation Preferences : HUL231, HUL232, HUL235, HUL236, HUL237, HUL240, HUL239*

The course will begin by seeking to distinguish the notion of 'creative' writing. It will contrast this heterogeneous category with other kinds of writing such as the 'functional' writing found in text-books and reportage. Through an analysis of various techniques of writing - in master-texts as well as students' own productions - the course will explore why and how literary texts continue to be a prime source of emotional and intellectual stimulation across cultures. As far as possible, the course will focus on contemporary writing, given that writers write in the 'here and now' even as they imagine the future or return to past memories. Selected readings will be used to focus students' attention on that most difficult of problems: to acquire a style of writing that makes a writer's 'voice' both unique and universal. Finally, students will be required to write in some genre(s) of their choice. These genres will include the classic areas of poetry, fiction and play-writing but will neither exclude non-fiction genres like the essay and biography nor forms of writing thrown up by the 'new media' such as blogs, photo-essays and narrative-writing for storyboards and video-games.

HUL338 Functions of Satire

3 Credits (3-0-0)

*Pre-requisite(s): Any Two courses from HUL2XX category**Allocation Preferences : HUL231, HUL232, HUL235, HUL236, HUL237, HUL240, HUL239, HUL256*

Satire is a classical genre that has thrived over the centuries in almost

all languages and cultures, and is found in a range of media. Life, in all aspects, everyday provides grist to the mill of satire, but does satire change anything? How do we define satire? Why is it considered the social genre? What are the contemporary forms of satire? Who can practice satire? It draws upon diverse techniques such as allegory, irony, caricature and laughter. Through analyses of examples, this course will familiarize students with satirical sub-genres and related literary practices, such as parody, burlesque, black humour, the grotesque, coarse humour, high and low comedy. It will examine the structure of satire, its relation with community, democracy and matters of gender, caste race, and religion.

HUL340 Selected Topics in Literature

3 Credits (3-0-0)

*Pre-requisite(s): Any Two courses from HUL2XX category**Allocation Preferences : HUL231, HUL232, HUL235, HUL236, HUL237, HUL240, HUL239,*

The course will introduce students to selected topics in Literature as decided by the instructor.

HUL341: Meaning in Natural Language

3 Credits (3-0-0)

*Pre-requisite(s): Any Two courses from HUL2XX category**Allocation Preferences : HUL242, HUL243, HUL282*

This course examines different aspects of meaning/semantics in language. Some specific questions addressed here are: a) what is meaning?, b) how do we use words to convey meanings?, and c) how does our grammatical knowledge interact with the interpretive system? We try to answer these and other questions while introducing students to the formal techniques used in research on the semantics of natural language.

HUL350 Selected Topics in Linguistics

3 Credits (3-0-0)

*Pre-requisite(s): Any Two courses from HUL2XX category**Allocation Preferences : HUL242, HUL243, HUL282*

The course will introduce students to selected topics in Linguistics as decided by the instructor.

HUL351 Philosophy of History

3 Credits (3-0-0)

*Pre-requisite(s): Any Two courses from HUL2XX category**Allocation Preferences : HUL251, HUL258, HUL253, HUL256*

What kind of understanding of the past does history provide? Is it speculative or analytical? What constitutes historical evidence and how does it confine historical understanding?

Questions of objectivity are the central focus of this course: that of historians themselves—constructionist and objectivist— as they debate methodological issues and disagreements about the aim of their discipline, and that of philosophers whose interest in history springs from their attention on history's objectivist ideals and "the objectivity crisis" in history providing a philosophical rationale for reframing the two oppositions that dominate debates about the status of historical knowledge.

HUL352 Problems in Classical Indian Philosophy

(3-0-0) 3 Credits

*Pre-requisite(s): Any Two courses from HUL2XX category**Allocation Preferences : HUL251, HUL258, HUL253, HUL256*

The course will begin by exploring the worldview implicit in the Vedas, the Upanisads, and the orthodox systems and then move on to the rejection of this entire system in Buddhism and Materialism. Emphasis will be led on the diversity of systems and healthy dialogue between antagonistic schools of thought. Discussions will focus on the nature of consciousness in relation to cognition of reality, theories of reality in terms of realism and anti-realism; the nature of self and no-self

theory, theories of perceptual knowledge, theories of error; theories of causation and other relations, and key concepts of moral and aesthetic thought. Wherever appropriate, problems will be discussed in comparison with parallel discussions in western philosophy

HUL353 Philosophical Themes in Biological Sciences

3 Credits (3-0-0)

Pre-requisite(s): Any Two courses from HUL2XX category

Allocation Preferences : HUL251, HUL258, HUL253, HUL256

This course addresses various philosophical questions that arise from the recent developments in evolutionary biology, genetics, immunology, sociobiology, molecular biology and synthetic biology. How do these developments affect our ideas about life, evolution and the place of man in relation to other living beings. What is the nature of explanation in biological sciences? Does the idea of immunity demand rethinking on the nature of our embodied self? What can biological sciences tell us about healing, pain and death?

HUL354 Art and Technology

3 Credits (3-0-0)

Pre-requisite(s): Any Two courses from HUL2XX category

Allocation Preferences: HUL251, HUL258, HUL253, HUL256, HUL290

The course begins by registering the increased presence of technology in contemporary art. We shall keep the experiences of both classical Greece and Classical India alive where art and technology were not clearly separated in the manner familiar to us. By positioning us between these two experiences - classical and contemporary we shall critically examine the complex relationship between art, science and technology which characterizes modernity. The course uses both materials from philosophical aesthetics, philosophy of science and technology. It also discusses the philosophical writings on specific areas like architecture, photography, cinema and digital art.

HUL355 Philosophy and Intellectual History in India

3 Credits (3-0-0)

Pre-requisite(s): Any Two courses from HUL2XX category

Allocation Preferences: HUL251, HUL258, HUL253, HUL256,

What defines the Indian tradition? Is there a singular Indian tradition or is there a plurality of Indian traditions in the public sphere today? How do these find representation in the modern and textual frameworks? Is modernity antithetical to tradition?

The aim of this course is to take up these varied questions along with their nuances to understand and re-negotiate Indian intellectual traditions.

In this course, the examination of sources, structure, texts and exemplars from Indian intellectual tradition provide a theoretical framework for the discussion of contemporary political and social issues. Economic development, social justice, religion and the nation, communalism and secularism, caste, class and gender equality are themes to be addressed. The political misuse of tradition in programs of reform and revival both in the past and in modern times will be highlighted to underline the need for rethinking Indian Philosophy and intellectual tradition in an academically rigorous manner.

This course will also take into cognisance the intellectual history of the ancient past as it comes through the Vedic thought and its contestations.

HUL356 Buddhism Across Time and Place

3 Credits (3-0-0)

Pre-requisite(s): Any Two courses from HUL2XX category

Allocation Preferences: HUL251, HUL258, HUL253, HUL256,

Literature on Buddhism and Buddhist literature brings out the historical, philosophical and political synthesis of Buddhism in ever new cultural contexts. Interrogating and contextualizing engagements of Buddhism's classical roots in modernity will be a key concerns in this course.

HUL357 Philosophy of Science

3 Credits (3-0-0)

Pre-requisite(s): Any Two courses from HUL2XX category

Allocation Preferences: HUL251, HUL258, HUL253, HUL256,

Science is regarded as the most significant cognitive enterprise of the modern society. In view of this, the course addresses the question what sets science apart from other epistemic activities. Further It concentrates on debates on the nature of scientific methods, logical reconstruction of scientific explanation, the relation between theories and laws on the one hand, and empirical evidence on the other, the nature of the justification and the notion of truth involved in scientific knowledge, and the societal influence on scientific practice.

HUL358 Philosophy of mind

3 Credits (3-0-0)

Pre-requisite(s): Any Two courses from HUL2XX category

Allocation Preferences: HUL251, HUL258, HUL253, HUL256,

Categorical taxonomy of Mental Phenomena: Intentional and Phenomenal.

Theories of the Mind-Body relation: Cartesian Dualism; Behaviourism; Identity Theory or Physicalism; Functionalism.

Personal Identity and the Self: The First-person Point of View.

Consciousness and Content: Phenomenal Intentionality; Representationalism; Internalism and Externalism about Experience; Qualia and the Knowledge Argument.

Consciousness and Self-consciousness: Pre-reflective Self-consciousness; One-level Accounts of Self-consciousness; Temporality and the Limits of Reflective Self-consciousness; Bodily Self-awareness; Social Forms of Self-awareness.

Critique of the Computational Theory of Mind: Searle's Chinese Room Argument and the Frame Problem.

HUL359 Metaphysics of the self

3 Credits (3-0-0)

Pre-requisite(s): Any Two courses from HUL2XX category

Allocation Preferences: HUL251, HUL258, HUL253, HUL256

The course is a critical study of the problem of the self taken to be a substance by some and denied to have any substantial reality by others. Focus will be given on examining the worldview from which stems the idea of a continuing self, as a subject of consciousness and agent of action. Questions about whether it is material or immaterial, real or nominal object will centre the ontological investigation into the nature of the self. Special consideration will be given to the issue of self-awareness and self-reference, and its relation to the linguistic phenomenon of the first-person pronoun 'I'.

HUL360 Selected Topics in Philosophy

3 Credits (3-0-0)

Pre-requisite(s): Any Two courses from HUL2XX category

Allocation Preferences: HUL251, HUL258, HUL253, HUL256

The course will introduce students to selected topics in Philosophy as decided by the instructor.

HUL361 Applied Positive Psychology

3 Credits (3-0-0)

Pre-requisite(s): Any Two courses from HUL2XX category

Allocation Preferences: HUL261, HUL265, HUL267

Meaning and goals of applied positive psychology; Relevant research methods of the field; Introduction to intervention programmes including internet based intervention; Researches that support intervention strategies : Psychological well-being and its intervention programmes; emotional intelligence and its intervention programmes; Strategies for achieving well-Being; Mindfulness and its intervention programmes; Intervention module on stress and time management; Character strengths : their role in well being; How psychosocial resources enhance health and well being; Intervention researches in Indian socio-cultural context; Current issues and future directions in this Area.

HUL362 Organizational Behaviour

3 Credits (3-0-0)

*Pre-requisite(s): Any Two courses from HUL2XX category**Allocation Preferences: HUL261, HUL265, HUL267*

Introduction to organizational behaviour, Historical development of the field and some challenges in contemporary times, Learning and perceptual processes in organizations and their implications for work-life, Work related attitudes- job satisfaction, organizational commitment, organizational justice, organizational citizenship behaviour, Individual differences related to personality, emotions and abilities and functioning in organization, Group processes in organizations, Formation of groups and teams, Effective teams, Communication in organizations, Social influence processes in organizations, influencing people, power dynamics and politics and impact on organizational functioning, Theories and styles of leadership in organization and their impact on organizational functioning, Organizational ethos and culture and its impact on productivity and well-being, Various kinds of organizational structures and their effectiveness, managing organizations in times of change.

HUL363 Community Psychology

3 Credits (3-0-0)

*Pre-requisite(s): Any Two courses from HUL2XX category**Allocation Preferences: HUL261, HUL265, HUL267*

Introduction to Community Psychology; Understanding Individuals within Environments; Individualism collectivism & community Psychology; Understanding Human Diversity; Understanding Coping in Context; Community and Social Change; Prevention and Promotion: Key Concepts, Current and Future Applications & implementing programs; Overview of Community Interventions; Social support research in community psychology; Recent community researches in Indian socio- cultural context: Effects of various socio- cultural issues on individual and community well-being.

HUL364 Understanding the Social Being

3 Credits (3-0-0)

*Pre-requisite(s): Any Two courses from HUL2XX category**Allocation Preferences: HUL261, HUL265, HUL267*

The social being- introducing the social psychological approach, Historical roots, theories and methods. Person and social perception and social judgements. Social cognition and social thinking. The social self- cognitive, affective and behavioural aspects of self. Positive social behaviours- altruism, cooperation and volunteerism. Individuals in groups- social facilitation, loafing, conformity, compliance. Social influence, manipulation and power- bases of power. Intergroup relations- explanations and managing intergroup relations. Collective behaviour- crowds and mobs- negative and positive aspects of collective behaviour. Aggression and violence- theories and determinants. Reducing aggression and violence. Applications of social psychology- health and well-being, law and organizational contexts.

HUL365 Environmental Issues: Psychological Analysis

3 Credits (3-0-0)

*Pre-requisite(s): Any Two courses from HUL2XX category**Allocation Preferences: HUL261, HUL265, HUL267*

The implications of natural, built and social environment on human functioning, Making sense of environment-environmental perception and cognition, Nature of environmental attitudes and implications for inculcating pro-environmental attitudes, Various kinds of environmental stressors and human response to these stressors, Psychological analysis of climate change related issues, Psychology and energy conservation- social and collective dilemmas and individual interests, Environmental disasters and disaster preparedness, Assessing environmental risks, Place attachment, territoriality, personal space and notion of privacy and identity issues, Designing better environments and role of psychological factors in the design process, Examining specific built environments.

HUL370: Selected Topics in Psychology

3 Credits (3-0-0)

*Pre-requisite(s): Any Two courses from HUL2XX category**Allocation Preferences: HUL261, HUL265, HUL267*

The course will introduce students to selected topics in Psychology as decided by the instructor.

HUL371 Science, Technology and Society

3 Credits (3-0-0)

*Pre-requisite(s): Any Two courses from HUL2XX category**Allocation Preferences: HUL271, HUL272, HUL274 HUL275, HUL276, HUL281, HUL286, HUL289, HUL290*

The course will begin with social theories on the production of technology and scientific knowledge systems, stratification within the community of technologists and scientists, discrimination (race, class, gender, caste) and the role of power in shaping the production of technology and scientific knowledge. Scientific controversies, both historical and emerging, and the organization of innovation and its geographies will be discussed. Case studies exploring ethical questions arising from new technologies such as information technology, nanotechnologies, biotechnologies, etc. will be used. Discussions on public understanding of science and role of the public and of experts in influencing policies related to science and technology will conclude the course.

HUL372 Agrarian India: Past and Present

3 Credits (3-0-0)

*Pre-requisite(s): Any Two courses from HUL2XX category**Allocation Preferences: HUL271, HUL272, HUL274 HUL275, HUL276, HUL286*

The course will use interdisciplinary texts to give students a historical overview of agrarian India starting from the colonial period, plantation and export economies, recurring famines, community development programs and land reforms after independence, the green revolution, and the neglect of rainfed/dryland regions. It will explore various dimensions of development in agriculture including the advent of the agricultural sciences and the birth of the agricultural extension system. The myth of the ignorant farmer and the self-sufficient village will be discussed. Case studies on the historical roots of globalization and agricultural commodity chains related to new technologies, and the linkages between the market and the state in contemporary agriculture will be discussed. The growing social and geographical disparity with ecological distress and the threat of climate change, farmer suicides, and debt spirals on the one hand, and a risky but rewarding cash crop economy on the other, will also be explored. Finally the course will discuss aspirations of rural youth, opportunities for livelihoods, and gender and caste dimensions of the growing urbanization of rural centres.

HUL374 Nations and Nationalism

3 Credits (3-0-0)

Pre-requisite(s): Any Two courses from HUL2XX category

The Course is designed to introduce students to a critical understanding of the nation as a historical and social fact, and nationalism as the feeling of collective belonging to the nation. Building on sociological understanding of collective identity, the course will cover various theories of nationalism and touch upon different aspects of nationalism for instance, race, class, gender, ethnicity, culture, language, sports and religion among others. In an increasingly globalizing world? Or does the idea of the nation still arouse anxiety over collective identity? In addition to assigned texts and films, students will be expected to work on in-class activities and assignments designed to further their understanding of the topic.

HUL375 The Sociology of Religion

3 Credits (3-0-0)

Pre-requisite(s): Any Two courses from HUL2XX category

Allocation Preferences: HUL271, HUL272, HUL274 HUL275, HUL276, HUL286

This course will introduce students to sociological approaches to the study of religion in contemporary society. Religion will be understood in terms of its social and cultural structure; in addition the course will also encourage a critical perspective on religion and society – its interface with society, polity and the economy. Religious conflict and change, syncretism, popular religion, revivalism and fundamentalism will also be considered.

HUL376 Political Ecology of Water

3 Credits (3-0-0)

Pre-requisite(s): Any Two courses from HUL2XX category

Allocation Preferences: HUL271, HUL272, HUL274 HUL275, HUL276, HUL286

This course is an advanced undergraduate sociology course on the political ecology of water. It discusses people's historic and current engagement with water, sustainable development and water, the recent controversies and emergent resource conflict over water in the context of industrial development, design and implementation of hydropower projects, water pollution management, and conservation strategies (modern and traditional) and relates them to relevant national policies.

HUL377 Gender, Technology and Society

3 Credits (3-0-0)

Pre-requisite(s): Any Two courses from HUL2XX category

Allocation Preferences: HUL271, HUL272, HUL274 HUL275, HUL276, HUL286, HUL289, HUL290

The manner in which gender is conceptualized and performed is foundational to the understanding of human social relationships. Gender identities are not fixed or determined purely by physiology; their social construction affects ideas of masculinity and femininity or other sexual identities. Besides understanding how sex and gender are interrelated, we will look at how gender intertwines with societal areas of economy, technology, polity, religion and demography. The important role played by social structures and institutions such as caste, kinship, family, marriage, ethnicity, religion and class in structuring gender and vice-versa will be brought out.

Technologies associated with population and biological sciences have transformed and are continuing to transform society and human relationships in particular directions. The course will examine these transformations at the global and local levels and consider their impact on individual lives. Challenges posed to intimate human relationships and identities by new reproductive technologies such as invitro-fertilization, surrogacy, sex selection will be explored. What does the emergence/ institutionalization of new social forms - such as same sex marriages and parenthood by surrogacy - tell us about the possibilities and limits of human relationships?

HUL378 Industry and Work Culture under Globalization

3 Credits (3-0-0)

Pre-requisite(s): Any Two courses from HUL2XX category

Allocation Preferences: HUL271, HUL272, HUL274 HUL275, HUL276, HUL286

Globalization and Globality; Classical theories to understanding work and industry; Understanding Work, Work Ethic and Work Culture; Post-industrial society and rise of informational economy; Job-satisfaction and alienation; Equalization of Opportunities and the Flattening of the World; Outsourcing as a Business Strategy; Important changes in industry and rise of IT sector and BPO industry; Governance and Collective Organization of Workers in select sectors; Corporate Social Responsibility.

HUL380 Selected Topics in Sociology

3 Credits (3-0-0)

Pre-requisite(s): Any Two courses from HUL2XX category

Allocation Preferences: HUL271, HUL272, HUL274 HUL275, HUL276, HUL286

The course will introduce students to selected topics in Sociology as decided by the instructor.

HUL381 Mind, Machines and Language

3 Credits (3-0-0)

Pre-requisite(s): Any Two courses from HUL2XX category

Allocation Preferences: HUL243

Exploratory in nature, the course seeks to debate questions such as: What are the implications of conceiving the mind as a 'machine'? Can evolutionary theories about language and tool-using help us understand how we continually manage today to process the world around us 'online'? On this course, the class will be introduced to some state-of-the-art discussions in the interdisciplinary field of cognitive studies. These topics will include: (i) the modularity of mind (ii) the content of consciousness, (iii) the language bio-programme hypothesis, (iv) the relativism versus universals of controversy; (v) strong and weak positions on AI, etc. The course will rely on down-to-earth examples to demonstrate that such an interconnected area of study is not remote or esoteric but part of the intellectual excitement of living in the new millennium and attempting to anticipate both how it will shape us and how we will shape it.

HUL382 Romanticism: The Theory of Animals, Monsters and Machines

3 Credits (3-0-0)

Pre-requisite(s): Any Two courses from HUL2XX category

Allocation Preferences: HUL231, HUL235

There is more to romanticism than Wordsworth's poetry, or even literature in general. Nor is it confined between 1780s and 1830s. Least is it a trend succeeded by Victorianism and realism, and assailed by modernism. Romanticism contends with the question of presentation – of representation of and to oneself. It therefore directly participates in the philosophical discussions of reason, sensibility, emotion, subjectivity, and most importantly the idea of human freedom. This course will familiarize students with romantic movements in arts, in theories of language and society, in post-Kantian philosophy, in attitudes to religion. Romantics not only engaged in experimental social practices and literary collaborations, but also articulated their necessity for the first time. Can we say that romanticism is at an end? How does it contribute to both a nationalism rooted in folk tradition, and individualism expressed in the cult of the hero, the solitary intellectual? How does it both look back to medieval occult and forward to novelties of science? Why is romanticism fascinated with animals, monsters and machines alike?

HSL511 Microeconomics I

4 Credits (3-1-0)

Pre-requisite(s): Only for M.Sc. (Economics)

This course provides an introduction to microeconomic theory and is the first course in the microeconomic theory series. The course will begin with detailed analysis of consumer's choice behaviour and required mathematical tools from optimization theory and real analysis would be reviewed. Producer's behaviour is analyzed next where emphasis is put on characterization results under different market structures, especially strategic aspects in an oligopolistic market. The next topic is analysis of decision-making under uncertainty and Anscombe-Aumann framework is introduced. Next non-expected utility theories are covered, Topics of recent and relevant interest will also be covered if time permits.

HSP511 Economics Lab

4 Credits (0-0-8)

Pre-requisite(s): Only for M.Sc. (Economics)

Experiment with sample survey data in India like IHDS, NSSO, NFHS and census data, forecasting of macroeconomic data, simulation exercise, replication exercises

HSL512 Macroeconomics I

4 Credits (3-1-0)

Pre-requisite(s): Only for M.Sc. (Economics)

This course begins with a detailed study of macroeconomic concepts, which include an analysis of India's national income and balance of payments data. It provides an understanding of the contending theories of employment, income distribution, money supply, and price-wage relationships. The course also deals with exchange rates and other open economy macro issues. It discusses the classical and neoclassical theories of the macro economy, as also the critiques of these theories by Keynes, Kalecki, and their followers. In some part of this course, students will be introduced to the emerging field of Macroeconomics along the line of Real Business Cycles and Dynamic Macroeconomics (Ramsey economy). The course examines macroeconomic policies, and the challenges faced by governments and the Central Banks in implementing them, especially in the context of the integrated nature of global finance and production.

HSL513 Probability and Statistics for Economics

4 Credits (3-0-2)

Pre-requisite(s): Only for M.Sc. (Economics)

Probability and Distribution Theory, Estimation and Inference, ANOVA, Linear Regression Model, Least Squares Estimator, Hypothesis Tests and Model Selection.

HSL514 Issues in Development

3 Credits (3-0-0)

Pre-requisite(s): Only for M.Sc. (Economics)

The course will be a survey of the major issues and debates related to development. It discusses the emergence of industrial capitalism in Europe and North America, as well as the economic development experiences of Asian countries including China. The course will with the impacts of globalization and the crisis in global capitalism that deepened since 2008. Issues related to inequality, human development, labour rights, and migration will also be covered. The course will pay special attention to development problems of India, particularly issues related to gender, caste and class.

HSL515 Indian Economy

3 Credits (3-0-0)

Pre-requisite(s): Only for M.Sc. (Economics)

This course discusses the various phases and issues with respect to India's economic development. The topics discussed include India's economic development challenges during the colonial and the planning periods, and economic growth under liberalization. The course will deal with the varied inequalities in the country, along the lines of caste, class, and gender, as well as across regions. It will feature issues related to Indian agriculture, industry, services, as well as trade and investment. The course will aim to provide various points of view on each of these topics.

HSL516 Mathematical Economics

4 Credits (3-1-0)

Pre-requisite(s): Only for M.Sc. (Economics)

This course is an overview of topics in calculus, advanced calculus, optimization, and linear algebra that are relevant to economic theory. It provides some of the necessary mathematical background to begin the core graduate sequence. The course covers a large amount of material at a relatively high level of rigor.

HSP520 Research Project in Economics I

3 Credits (0-0-6)

*Pre-requisite(s): Only for M.Sc. (Economics)***HSL521 Introduction to Cognitive Science**

4 Credits (3-0-2)

The course aims to provide an overview of Cognitive Science. On

successful completion of the course, a student should be able to appreciate the historical context, key questions, foundational issues and the various disciplinary approaches that address the questions about cognition using diverse methodology.

HSS521 Independent Study in Cognitive Science (Bridge course)

2 Credits (0-2-0)

The course is intended to act as a bridge course to supplement the academic background of the first semester students with foundational subjects required to study cognitive science such as mathematics, biology, etc.

HSL522 Basics of Programming for Cognitive Science

2 Credits (1-0-2)

The aim of this course is to introduce beginners to the basics of programming using Python. On successful completion of this course, the student will be able to write, debug and test simple programs to solve computational problems. Students will learn to use elementary data structures and manipulate the control flow of the program. They will be familiarized with algorithmic techniques to solve problems like search and sort, etc.

HSL541 Language in the Mind

4 Credits (3-1-0)

All human beings without exception learn and use language. Yet, it is more common to associate it with cultural phenomena than as a cognitive or biological phenomena. The objective of this course is to look at language as a form of computation in the mind. It will introduce both symbolic and non-symbolic approaches that have been used by linguists and computer scientists to understand the computational mechanism of languages in the mind. On successful completion of the course, students will be familiar with the use of a few analytical tools used in linguistics to make generalizations about natural languages.

HSL561 Cognitive Neuroscience

4 Credits (3-0-2)

The course will provide a scientific understanding about the basics of how the brain functions and relate it to cognition. It would introduce the methods and approaches prevalent in cognitive neuropsychology that provide the neuroscientific basis of core cognitive processes. The lab sessions introduce students to recording/analyzing neurophysiological data as assigned by the instructor.

HSL611 Microeconomics II

4 Credits (3-1-0)

Pre-requisite(s): Only for M.Sc. (Economics)

Arrow-Debreu framework is established and equilibrium notion is introduced. Existence properties are discussed and formally proved. Stability of the equilibria is discussed and the conditions are introduced. Uniqueness is discussed next. In game theory, we start by introducing the basic set-up of a complete information simultaneous move game. The concept of Nash equilibrium is formally discussed. The existence of Nash equilibrium is proved and the related conditions are introduced. The assumption of complete information is relaxed next and Bayes Nash equilibrium is introduced. The sequential game concept is defined next and the appropriate notion of equilibrium is discussed. Several examples from market structures, auctions, voting etc. are used to motivate the notions and explain the concepts.

HSP611 Advanced Economics Lab

4 Credits (0-0-8)

Pre-requisite(s): Only for M.Sc. (Economics)

Impact evaluation, Randomised Control Trial, Natural experiment methods like Regression Discontinuity, Instrumental Variable, experiment in behavioural economics, experimental game theory, cost-benefit analysis of policies.

HSL612 Macroeconomics II

4 Credits (3-1-0)

Pre-requisite(s): Only for M.Sc. (Economics)

The course aims to develop an understanding of the process of economic growth and income distribution in an economy. Historical and contemporary experiences of countries on growth and developmental outcomes will be dealt with in this course. The impacts of capital accumulation, technological progress, and international trade on economic performance will be discussed. Further, this course will focus on how global capital movements, domestic institutions and political economy can affect economic growth and development.

HSP612 Research Seminar in Economics

3 Credits (1-0-4)

Pre-requisite(s): Only for M.Sc. (Economics)

Current trends in research in economics, practices and professional standards of research, organising research output, dissemination process, review and editorial process.

HSL613 Econometrics

4 Credits (3-0-2)

Pre-requisite(s): Only for M.Sc. (Economics)

Linear regression models, heteroskedasticity, autocorrelation, generalized least squares, endogeneity issues, instrumental variable estimation, limited dependent variable models, econometrics with time series data, linear models with panel data.

HSL614 Development Economics

3 Credits (3-0-0)

Pre-requisite(s): Only for M.Sc. (Economics)

Some of the topics that will be covered in this course include poverty, inequality, education, health, and gender aspects of development. The course will deal with history and persistence in development, as well as with the roles of agrarian institutions and credit markets. Other topics covered will include culture, social capital, behaviour, corruption, violence and conflict. The impacts of international trade, foreign aid, and foreign investment on development will also feature in this course.

HSP620 Research Project in Economics II

9 Credits (0-0-18)

*Pre-requisite(s): Only for M.Sc. (Economics)***HSL621 Mathematical Foundations for Cognitive Science**

3 Credits (2-1-0)

Pre-requisite(s): HSS521

The course will provide an introduction to basic mathematical concepts. The aim will be to prepare students to be able to think formally and quantitatively about how to model cognitive phenomena. An attempt will be made to contextualize the topics within the domain of cognitive science.

HSL622 Computation and Cognition

4 Credits (3-0-2)

The course will provide an introduction to computational ideas in cognitive sciences which has overlapped between the study of natural and artificial intelligent systems. Moving from human cognition, the course will cover topics in machine cognition that will enable students to see a larger picture of how cognition and computation are entwined.

HSL651 Philosophy of Mind and Cognition

4 Credits (3-1-0)

This course discusses foundational debates and issues in cognitive science. It addresses core issues that relate to consciousness, knowledge, representation, perception and action that explicates the positions of key thinkers in the field, mainly from a theoretical and philosophical angle.

HSL661 Cognitive Processes: From Labs to Fields

4 Credits (3-0-2)

The course will introduce students to the core cognitive processes providing foundational knowledge about how humans think. The lectures will explicate the underlying cognitive mechanisms and encourage students to delve how cognitive processes operate in and out of the labs.

HSP700 Workshop on Scientific Writing

2 Credits (0-2-0)

This course is a Re-writing course rather than a writing course. While the act of writing is about what-to-write, the act of re-writing is about how-to-write. Logically, just as re-writing cannot precede writing, decisions on how-to-write cannot precede what-to-write. The issue is that by truncating or entirely omitting the step of re-writing, we end up with a write-up where the author did not take any authorial decisions regarding how-to-write. If the act of writing involves expressing one's ideas and reporting one's results, then the act of re-writing entails reading and organizing ideas, discovering and highlighting implications, editing the language and eventually evaluating one's work from the perspective of a reader.

HUD700 Seminar (Case Material-based) Minor Project

3 Credits (0-0-6)

Students would under take a supervised research project.

HUL704 Inclusive Innovation: Theory and Practice

4 Credits (2-0-4)

The course will familiarize students with key concepts in innovation, including various elements of the innovation cycle going all the way from need identification to deployment. Key aspects relating to inclusive innovation - the public goods nature of many basic needs, user and market characteristics, delivery and scaling-up considerations, and the role of partnerships and policies - will receive particular focus. The students will also be introduced to the state-of-the-art thinking in organizing for innovation, especially for the bottom of the pyramid. This theoretical knowledge will be complemented with hands-on exercises aimed to familiarize students with some of the key issues in coming up with technologies and products for the marginalized, including user needs and context analysis, ideation involving user interaction and co-creation, and assessment of the potential of technology for success.

HUL706 Language, Society and Culture

3 Credits (2-1-0)

Psycho-linguistics and sociolinguistics; culture and identity studies; studies in expressive culture: idea-systems, myths and archetypes.

HUL707 Social Psychology

3 Credits (2-1-0)

Schools of social psychology with special reference to personality and social structure. The problems and methods of social psychology. The association motive. Interpersonal attraction. Learning in social context. Social motives and attitudes. Social influence. Dissonance. Consonance and balance. Social status: Its effect on social motives and behaviour, social roles. Personality and social phenomenon. Cultural influences on personality and social behaviour. Social perception communication. Group process. Group task performance : Problem solving co-operation and competition. Leaders and leadership. Power and politics in organisations. Psychological processes in organizations. Aggression and its management.

HUL709 Social Research Methods

3 Credits (2-1-0)

Scientific approach to social research. Concepts and indices. Analytical and formal aspects. Hypothesis formulation and testing strategies. Design of applied empirical research. Measurement and interpretation of social data. Social statistics. Sampling designs, report writing.

HUL710 Personality Structure and Dynamics

3 Credits (2-1-0)

The topics for discussion will be : Coping with stress. Model of success and failure in adjustment. Approaches to the study of personality. Freud's classical psychoanalytic theory, Jung's analytic theory, Adler's individual psychology, Roger's person- centred approach. Lwein's field theory, Skinner's operant reinforcement theory. Erikson's theory: Psychohistorian perspective of man. Models of healthy personality; mature person: Allport's model. Self-actualising person: Maslow's model. Here-and-now person: Perl's model. Roger's theory : on becoming a person.

HSL711 Macro Development Economics

3 Credits (3-0-0)

Pre-requisite(s): For HES students (M.Sc. in Economics)-- Completion of core courses. Not allowed to take this courses in the first year. For UG students--any ONE of: HUL212, HUL213, HUL311, HUL312, HUL211, HUL314, HUL318, HUL320

This course covers the following topics: significance of agriculture in developing countries, poverty and population issues facing the world, international trade, and importance of foreign aid, poverty and income distribution, the role of geography and institutions, fertility and population growth, the role of credit markets and microfinance, health and nutrition, education, female empowerment, the meaning and measurement of economic development, etc.

HUL711 Psychological Testing & Behavioral Assessment

3 Credits (2-1-0)

The concept of Behavioral Assessment: Uses and Varieties of Psychological Tests, Why Control the use of Psychological Tests? Test Administration, Examiner and Situational Variables and Effects of Training on Test Performance.

Technical and Methodological Principles: Test Construction, Norms and The Meaning of Test Scores, Reliability and its Types, Validity and its Basic Concepts and Item Analysis.

Other Techniques of Behavioral Assessment: Interview, Questionnaire and Schedule, Content Analysis, Observation as a tool of data collection, Rating Scales, Survey and Projective Techniques. Brief Review of some Selected Psychological Tests and Concluding Comments.

Ethical and Social Considerations in Testing: Ethical Issues in Behavioral Assessment. User Qualifications and Professional Competence, Responsibility of Test Publishers, Protection of Privacy, Confidentiality and Communicating Test Results.

HUL712 Microeconomics

3 Credits (3-0-0)

Pre-requisite(s): For UG students: HUL212&HUL311

This course provides an introduction to microeconomic theory and is the first course in the microeconomic theory series. The course will begin with detailed analysis of consumer's choice behavior and required mathematical tools from optimization theory and real analysis would be reviewed. Producer's behavior is analyzed next where emphasis is put on characterization results under different market structures, especially strategic aspects in an oligopolistic market. The next topic is analysis of decision-making under uncertainty and Anscombe-Aumann framework is introduced. Next non-expected utility theories are covered, Topics of recent and relevant interest will also be covered if time permits.

HUL713 Macroeconomics

3 Credits (3-0-0)

Pre-requisite(s): For UG students--any ONE of: HUL211, HUL212, HUL213, HUL311, HUL312, HUL314, HUL315, HUL318, HUL320

This course begins with a detailed study of macroeconomic concepts, which include an analysis of India's national income and balance of payments data. It provides an understanding of the contending theories of employment, income distribution, money supply, and

price-wage relationships. The course also deals with exchange rates and other open economy macro issues. It discusses the classical and neoclassical theories of the macroeconomy, as also the critiques of these theories by Keynes, Kalecki, and their followers. The course examines macroeconomic policies, and the challenges faced by governments and the Central Banks in implementing them, especially in the context of the integrated nature of global finance and production.

HUL714 International Economics

3 Credits (3-0-0)

Pre-requisite(s): For UG students--any ONE of: HUL211, HUL212, HUL213, HUL311, HUL312, HUL314, HUL318, HUL320

This course discusses the various theories on trade, including the Ricardian and Heckscher-Ohlin models. It deals with instruments of trade policies, and also the political economy issues such as trade agreements under the WTO. It examines how international trade affect developing countries, with a particular emphasis on the Indian case. Further, the course will trace the emergence of the international monetary system, including the international gold standard and the Bretton Woods system. The ascent of global finance and its implications for macroeconomic policymaking will be covered in this course. Theories on finance, financial regulation and financial crises will also be discussed in this course.

HUL715 Time Series Econometrics and Forecasting

3 Credits (3-0-0)

Pre-requisite(s): For UG students: HUL315 / HUL215

1. Stationary Univariate Models : (a) Difference equation; (b) Wold's decomposition; (c) ARMA models; d. Box-Jenkins methodology; (e) Model Selection; (f) Forecasting.

2. Non-stationary univariate models: (a) Trend/cyclical decomposition; (b) Deterministic and stochastic trend models; (c) Unit root tests; (d) Stationarity tests.

3. Structural change and non-linear models: (a) Test for structural change with unknown change point; (b) Estimation of linear models with structural change; (c) Regime switching models.

4. Stationary multivariate models; (a) Dynamic simultaneous equation models; (b) Vector Auto Regression (VAR); (c) Granger causality; (d) Impulse response function.

5. Non-stationary multivariate models: (a) Spurious regression; (b) Co-integration; (c) Vector Error Correction (VECM) model.

6. Time series model of heteroskedasticity: (a) ARCH, GARCH models.

HUL716 Industrial Economics

3 Credits (3-0-0)

Pre-requisite(s): For UG students: HUL212 & HUL311

The course aims to formalize microeconomic treatment of industry and firm's behaviour, decision-making in consumer's choice problems, rationality theory (as well as its exceptions). Emphasis will be put to conceptualize various aspects of firm's and consumer's choice. Market structures, pricing under alternative market structures, market power and concentration will also form an integral part of the course. Behavioural and strategic aspects of the agents would be emphasized in various cases e.g. auctions, economic networks etc.

HUL717 Perspectives on Indian Economy

3 Credits (3-0-0)

Pre-requisite(s): Any ONE of: HUL211, HUL212, HUL213, HUL311, HUL312, HUL314, HUL318, HUL320

This course discusses the various phases in India's development transition. They include the economic changes during the colonial period, development under the planning regime, the transition from state to markets in India, and economic growth under liberalization. The course will deal with the varied inequalities in the country, along the lines of caste, class, and gender, as well as across regions. It will feature issues related to Indian agriculture, industry, services, as well as trade and investment. The course will aim to provide various points of view on each of these topics.

HUL718 Political Economy of Development

3 Credits (3-0-0)

Pre-requisite(s): Any ONE of: HUL211, HUL212, HUL213, HUL311, HUL312, HUL314, HUL318, HUL320, HUL271, HUL272, HUL275, HUL281, HUL286, HUL289, HUL310

The course will be a survey on the theories and issues related to the political economy of development. It discusses the emergence of industrial capitalism in Europe and North America, as well as its spread to third world countries since the mid-twentieth century. The course will deal with contemporary issues such as the growth of international trade and finance, the emergence of China as a global economic power, and the crisis in global capitalism that deepened since 2008. Issues related to human development, labour rights, migration and environmental sustainability will also be covered.

HUL719 Advanced Econometrics

3 Credits (3-0-0)

Pre-requisite(s): For UG students: HUL315 / HUL215

Course contents (about 100 words) (Include laboratory/design activities):

1. Review of Classical Linear Regression Model: Gauss-Markov assumptions, finite sample properties, large sample properties.
2. Instrumental Variable Estimation: Motivation for instrumentation, Simultaneity Bias, Endogeneity and Measurement Error; IV Estimation; 2SLS Estimation.
3. Generalized Method of Moments: Single equation linear GMM.
4. Systems of Equations: Seemingly Unrelated Regressions (SUR) model; Simultaneous Equations Models: Identification.
5. Panel Data models: Pooled Estimation; Unobserved Heterogeneity: Fixed vs. Random Effects; ML vs. GMM estimation.
6. Discrete Choice Models: Binary response models, Multinomial Response Models, Ordered Response Models.
7. Censored Regression Models: Estimation and Inference with Censored Tobit.
8. Estimating Average Treatment Effects: Regression Methods, Methods Based on the Propensity Score, Estimating the ATE Using IV.

HUL720 Development Economics

3 Credits (3-0-0)

Pre-requisite(s): For UG students--any ONE of: HUL211, HUL212, HUL213, HUL311, HUL312, HUL314, HUL315, HUL318, HUL320

This course discusses experiences in economic growth and development transitions from around the world. Some of the topics that will be covered in this course include poverty, inequality, education, health, and gender aspects of development. The course will deal with history and persistence in development, as well as with the roles of agrarian institutions and credit markets. Other topics covered will include culture, social capital, behavior, corruption, violence and conflict. The impacts of international trade, foreign aid, and foreign investment on development will also feature in this course.

HSL721 Research Methods in Cognitive Science

3 Credits (1-0-4)

The course will introduce the key concepts and techniques in qualitative, experimental and computational paradigms. In the qualitative approach, focus will be on meaning making rather than information processing in the study of mind. Philosophical foundations of qualitative paradigm will be introduced. We will highlight how it complements rather than contradicts with experimental and/or computational approaches to research. In the experimental approach, the student will be taught how to design his/her own experiment independently. The student will be made aware of the key concerns that must be kept in mind while conducting an experiment, and how one can translate a research hypothesis to testable experiments that can be relied upon.

Finally, in the module on the computational approach, we will expose students to computational data analysis and machine learning techniques deployed for data-driven research, and how the outputs of such techniques can be assessed and interpreted.

In all the modules, the students will learn how to frame a research question in order to address an important issue related to cognitive science.

HSL722 Data Analysis for Behavioral Research using R

4 Credits (3-0-2)

Pre-requisite(s): HUL 242 and HSL 745 for UG and non-HUSS, PG students.

On the successful completion of this course, a student will be able to independently use R for analyzing standard behavioral experimental data. The data can pertain to measures such as reaction times, eye-fixation measures, grammaticality judgments, correct-incorrect question response etc. In addition, the course will also equip the student with experimental-data visualization techniques.

HSL723 Advanced Computational Methods

1.5 Credits (0.5-0-2)

Pre-requisite(s): HSL721

On successful completion of this course, a student will obtain a practical but in-depth introduction to computational models for problems such as classification and regression. This is aimed to be an advanced course for computational methods. The course will first introduce the students to the basics of computational modeling. We will discuss examples of computational models and the question of what can be learnt. Students will be introduced to two learning algorithms: decision trees and logistic regression. They will learn about validation of their models, both internally and externally. During the course practical, they will get the opportunity to train their own computational models to solve a simple problem.

HSL724 Advanced Experimental Methods

1.5 Credits (0.5-0-2)

Pre-requisite(s): HSL721

On successful completion of this course, a student should be able to design his/her own experiment independently. Assuming the basics of the course on research methods, the course will focus on different experimental paradigms such as eye-tracking, etc. The course will first summarize the basics of experimentation. Following this, we will focus on a particular experimental paradigm (e.g., Eye-tracking, EEG) where the key concepts related to the paradigm will be discussed. Some research papers that have used this paradigm in domains such as attention, language processing, etc. will be discussed. Advantages and challenges to the paradigm will be discussed. In addition, practical sessions will be conducted to get a hands-on experience on a particular paradigm.

HSL725 Advanced Qualitative Methods

1.5 Credits (0.5-0-2)

Pre-requisite(s): HSL721

This course will introduce the philosophical foundations of qualitative paradigm and discuss how it complements rather than contradicts with experimental and/or computational approach to research. The students will learn how to frame a research question, to collect and analyze qualitative data in order to address an important issue related to cognitive science.

HSL726 Culture and Cognition

3 Credits (3-0-0)

Pre-requisite(s): HSL521

This course examines how culture shapes cognition. The goal is to help students appreciate the theoretical and empirical issues critical to the understanding of cross-disciplinary research on the relationship between the cognitive and cultural domains. The approach will be integrative, drawing from cultural psychology and related disciplines

to enable students to gain a comprehensive understanding. The objective of this course is to sensitize students to cross-cultural and sub-cultural variations and issues. This course will encourage students to view psychology from a broader cultural perspective and appreciate the importance of culture in understanding the human cognitive processes.

HSL727 Advances in Social Cognition

4 Credits (3-0-2)

Pre-requisite(s): HSL661 (for MSc Cognitive Science students)

This course will provide an overview of the major theoretical debates and empirical developments in the area of social cognition, with a central focus on the group processes. Students in this class will be directly exposed to many of the core ideas in the field by reading classic and contemporary articles. The readings will provide an in-depth exploration of evaluation and cover key empirical and theoretical developments in the field of attitudes.

HUL731 What is a Text

3 Credits (3-0-0)

We will study the fundamental assumptions supporting the various definitions of text, and their possible mutual incompatibility, for the ways in which the question "what is a text" exposes the issues in characterizing, interpreting and attributing meaning to text. The course will take into account hermeneutic, phenomenological and deconstructionist theories of text, the historicity of the idea of text, the distinctions between text and work, the metaphysics of text and its epistemological status, and the possibility of classifying kinds of text. It will also consider the different cultural ways of producing, circulating and relating to texts.

HUL732 Contemporary Critical Theory

3 Credits (3-0-0)

Pre-requisite(s): For Ph.D. students: No prerequisites for all other students: Any one of the following: HUL331, HUL332, HUL333, HUL334, HUL335, HUL336, HUL337, HUL338, HUL339, HUL340

A particular theoretical position would be explored through the detailed study of selected work which trace the history of the development of that critical position. The study would also include the analysis of a text which would illustrate the critical position being studied.

Detailed course contents would be announced by the course coordinator at the time of offering the course.

HUL733 Study of an Author/Writer in Focus

3 Credits (3-0-0)

- Brief biography and study of the historical/social context of the selected writer
- Intellectual milieu of the writer
- Overview of the major works and overall trajectory of the development of his/her thought
- Understanding the influences and impact of the work/s
- Detailed study of the selected text/s

HUL734 Themes in Modern Indian Thought

3 Credits (3-0-0)

This course will focus on significant themes in modern Indian thought (Equality, Freedom, Sexuality, Gender, Caste, Religion, Violence, Modernity, Education, the Arts etc) and introduce students to major works that engage the specific theme(s) that have been chosen. Works studied may be cinematic, theatrical, fictional or non-fictional. The course will study both the genealogy of significant concepts in modern Indian thought (examining English as well as non-English language materials) as well as the range of debate about these concepts and their deployment. The course is envisaged as an interdisciplinary course, though we will pay close attention to

questions of reading, textuality and interpretation. Lecture outline given for a possible course on gender and sexuality, as ONE possible example of a theme that could be pursued.

HUL735 Research Methods in Economics

2 Credits (1-0-2)

Pre-requisite(s): Either HUL701 or HUL 707 or HUL736 OR HUL738 or HUL754 or HUL755 or HUL761 or HUL762

The course will cover theory and practice of doing applied research in economics, with special emphasis on primary and secondary data uses. The course will familiarize students with sampling techniques, questionnaire design, implementation of field-based studies, including randomized controlled trials. Students will be provided training in STATA for carrying out data analysis, including use of data sets such as the National Sample Survey, National Family Health Survey, Indian Human Development Survey. Students will be expected to design and implement a small study during the course of the semester and will be evaluated on this.

HUL736 Planning and Economic Development

3 Credits (3-0-0)

Economic growth. Economic development. Historic growth and contemporary development. Lessons and controversies. Characteristics of developing countries. Obstacles to development. Structural changes in the process of economic development. Relationship between agriculture and industry. Strategies of economic development. Balanced/ Unbalanced growth. International trade and economic development. Population. Planning for economic development. Use of input-output model and linear programming techniques in planning. Indian plan experience. Strategy of Indian planning. Indian plan models.

HUL737 Advanced Economic Growth Theory

3 Credits (3-0-0)

Pre-requisite(s): either HUL736 or HUL738 or HUL755 or HUL762 or any other 7XX level economics course.

Primary objective of this course is to introduce students with the process of economic growth and the long run sources of differences in economic performances across nations. Emphasis will be placed on developing theoretical tool kits in understanding growth mechanics. It is intended that this course will make students learn some of the workhorse models in modern macroeconomics, namely, Solow model, Neo-classical model, overlapping generations' model, models with technological change and technology adoption etc.

HUL741 Sociolinguistics: Language Variation, Culture and Society

3 Credits (3-0-0)

Pre-requisite(s): HUL 234, HUL242 and HUL 350 for UG or Prior Permission of Coordinator

This course aims at understanding variation mainly from a sociolinguistics perspective, but while also considering some relevant cues from generative views of the phenomenon. It will cover aspects of language change (bilingualism, multilingualism, language deaths, pidgin and creole formation etc.) as explained by feature-based and parameter-based grammars, as well by socio-cultural-political factors. The focus will then shift towards how homogenization of language also happens - combating the natural tendency towards variation - triggered by external factors. Concepts of race, gender, nation and identity will also be brought up to show the pervasive role of language in varied aspects of our socio-cultural-political lives.

HUL742 Transformational Theories of Language

3 Credits (3-0-0)

Pre-requisite(s): HUL 234, HUL242 and HUL 350 for UG students and/or prior permission of the course coordinator

This course will cover the fundamental concepts that have defined

generative/transformational grammars since their inception in the 1950s. It will introduce students to the main motivations for such grammars for natural language, as stated in Chomsky (1957). A substantial part of the course will therefore be devoted to understanding the inadequacies of immediate constituent analysis and the need to include optional and obligatory transformational rules in the grammar. This will be followed by a detailed study of later theoretical developments, including those found in Standard Theory, Extended Standard Theory, Revised Extended Standard Theory and Government and Binding Theory.

HUL743 Language Acquisition, Teaching and Assessment 3 Credits (3-0-0)

This is a literature review course that will explore the existing literature in the domains of Language Acquisition (both first and second), Language teaching (approaches and methods), as well as language assessment. In doing so, the course will include aspects of the philosophy of language, and the resultant application of these philosophical approaches in the form of classroom pedagogy. The course will also include substantial literature on "action research" where language teachers have written about the results of implementing various cognitive tasks in their classroom.

HUL745 Psycholinguistics

3 Credits (3-0-0)

We will first introduce the relevant questions, theories, methodologies with regard to the historical trajectory of Psycholinguistics. We will then look at language processing at different linguistic dimensions. We will start with words, their meaning and access. We then look at processing sentences. The course will also cover important topics such as language and speech production. Reading processes (and its relation to processing) will be covered. We course will also cover the current theories of Bilingualism and Aphasia.

HUL746 Phonological Markedness

3 Credits (2-0-2)

Pre-requisite(s): HUL 234, HUL242 and HUL 350 for UG

This course explores the connection between a unit of acoustic speech signal and its environment (sounds preceding or following it). Phonological theory is thus composed on context-free and context-sensitive notions of markedness. While these are supposed to be universal, individual languages might vary significantly in prioritizing between these. The course therefore involves a major practical component where the speech units of individual languages (vowels, consonants and tones) are studied with respect to their phonological contexts.

HSL747 Language Computations and Mental Architecture

3 Credits (3-0-0)

Pre-requisite(s): HSL521, HSL541

The course introduces students to some fundamental concepts in the architecture of human/natural language, and the insights, thereof, for the architecture of the mind. It uncovers the core internal computations of the language module, while drawing comparisons with the communicative systems underlying non-human primate calls and bird songs. The aim is to teach students some long-standing debates on the layout and design of the human mind and the corresponding learning mechanisms and theories.

HUL748 Community Psychology

3 Credits (2-1-0)

Concept of community and their implications for community psychology. Community processes and orientations toward change. Examinations of the models; the mental health model; the organizational model; the social action model; the ecological model. Implications for a psychology of the community : the study of community life, interaction strategies; implications for manpower and training; family therapy and the community; crisis intervention; advocacy and community psychology.

HSL748 Natural Language Understanding

3 Credits (3-0-0)

Pre-requisite(s): HSL522, or similar programming course, or instructor consent

This course is designed as an introduction to the field of computational linguistics with a focus on linguistically motivated models of natural language understanding. It begins with an overview of discrete methods used in computational linguistics and from word level analysis to sentence level parsing. The course will also examine data-intensive approaches for these tasks.

HSL749 Optimality Theory and Harmonic Grammar

3 Credits (3-0-0)

Pre-requisite(s): For UGs: HUL242, HUL350, HUL381 and HUL234

The objective of this course is to study two models of constraint based grammars: namely Optimality Theory and Harmonic Grammar. While OT ranks constraints with respect to each other leading to a direct conflict between competing constraints, Harmonic Grammar positions these on a linear scale according to their weights.

HUL751 Critical Reading in Philosophical Texts

3 Credits (3-0-0)

The instructor will select a seminal text in philosophy and read it along with the class. Emphasis will be given to the textual material and issues in reading and understanding. An overview of the following will be provided: The nature the text, specificity of philosophical texts, text and context, issues in translation, interpretation and understanding.

HUL752 Philosophy of Social Sciences

3 Credits (3-0-0)

Some of the key issues which arise in Social Sciences will be discussed in this course. These are : (1) What is 'out there' in the social universe? (2) What are the most fundamental properties of the social world? (3) What kind(s) of analysis of these properties is (are) possible and/ or appropriate ? (4) What are the natures of theory, law, and explanation ? (5) Problems of reductionism. (6) Problems of free will versus determinism, purposeful behaviour, interpretations of actions. (7) Philosophical issues specific to various Social Sciences, e.g., philosophical bases of various economic theories, or of theories of psychology, or issues regarding the assumptions concerning human nature made by various social science disciplines.

HUL753 Philosophy of Science

3 Credits (3-0-0)

The course will address three sorts of questions. The first set involves the status of science as a privileged source of knowledge: what, if anything, justifies this status? The second set involves concepts such as 'law', 'cause', and 'explanation' which occur within scientific practice: how are these to be understood? The third set involves understanding the relationship between different scientific enterprises: is there a hierarchy of sciences ranging from physics at one end to the human or social sciences at the other? If so, how should this hierarchy be understood?

HUL754 The Philosophy of Plato

3.0 Credits (3-0-0)

This is a survey of Plato's thinking about politics, ethics, epistemology, and metaphysics. We will focus on a careful and critical reading of the primary texts, and attempt to get a sense both of their historical and cultural specificity, as well as their interest more generally as sources of philosophical insight.

HUL755 Fascism: Philosophical Perspectives

3 Credits (3-0-0)

Fascism is one of the pernicious forms of power that emerged in the 19th and 20th century and posed a serious to challenge democratic forms of life. The course will discuss the philosophical understanding of power, state, law, sovereignty and freedom with the special focus on gaining a conceptual grasp on fascism. Some of the classical and contemporary philosophers who have directly or indirectly contributed

towards constructing the intellectual edifice of fascism will be studied. Philosophical criticisms of fascism and the ethical and political explorations of resistance and the possibility of alternative forms of power and governance will also be studied. The bio politics of fascism, its relationship with Nazism, racism and religious and other forms of fanaticism, and the aestheticization of politics will also be covered.

HUL756 Philosophy and Film

3 Credits (3-0-0)

This course develops the conceptual resources of philosophy to respond to the cinematic image. The topics include: Ontology of the cinematic image; cognitive and phenomenological approaches to perception and imagination; relationship between representation and reality and between seeing and saying; space, time and image; movement and animation, memory, history, narrative; anthropology of images, truth in cinema; Cinema as art; Cinema's relationship to painting and literature; cinema and technology, the digital image.

HUL759 Urban Social Systems

3 Credits (2-1-0)

This course intends to impart a comprehensive and systematic understanding of urban social systems. Students completing this course will have a detailed knowledge of urban-growth and urban behaviour analysis, and urban-planning through a feedback analysis approach.

Following will be the main course contents:

Nature, types and growth of cities, Some important aspects of urban-systems: migration; neighbourhood; social groups; and voluntary associations. Trend of urbanisation. Urban influences on rural areas. A profile of urban India and its problems. Solution of the problems through various approaches. Urban planning.

HUL760 Industry and Society

3 Credits (2-1-0)

The basic aim of this course is to introduce students from various backgrounds scientists, technologists to the study and understanding of modern industrial societies. The course material will focus on the following topics.

Nature and type of industrial society. Workers in modern industrial societies: the work situation; alienation; and embourgeoisement. White collar worker. Trade-unionisation. Industrial democracy. Labour-management relations in Indian industries.

HUL761 Theories of Psychology

3 Credits (3-0-0)

The course will provide a history of the discipline of psychology and its evolution over the years. Major schools of psychology will be discussed. The key theories -psychoanalytic theory, the various learning theories, theories of emotion and cognition, humanistic approaches and evolutionary perspective will be the focus. Social psychology theories, cognitive and neuroscience perspectives and positive psychology theories will be discussed in detail.

HUL762 Social issues:Analysis and Policy

3 Credits (3-0-0)

The courses will focus on the following: Social psychological theory and application, examine the various methods of research, examine some social psychology applications and evaluate them. Issues of Inequality, deprivation and justice, in the context of Intergroup relations, Psychology of legitimacy, Violence, reconciliation and peace will be examined. Environment and energy conservation issues and applied research and the criminal justice system will be critically examined. Social psychology and social policy implications will be discussed.

HUL763 Cognitive Psychology

3 Credits (3-0-0)

The course will cover the following topics: Historical account of brain-mind, classification of cognition theories, methods of studying cognition, visual perception, top-down-bottom-up processing, visual recognition, information processing theories and attention, long-term memory, three stage theory of memory, types of memory, working

memory and executive processing, emotion-cognition, decision making and dual process theories.

HUL764 Psychological Interventions

3 Credits (3-0-0)

Introduction: Psychological Intervention modules including Yoga & Meditation; relevant research methods of the field specifically for intervention programmes development and evaluation -research design, testing, evaluation of results etc; Broad objectives of the field; Intervention programmes in the various field of psychology: Applied positive psychology, health psychology, applied social psychology, community psychology, cognitive psychology etc.; Meta - analysis research on intervention programmes; Intervention programmes in Indian setting and role of socio -cultural factors; Critical evaluation and Future orientation of the field.

HUL765 Psychological Testing and Behavioral Assessment

3 Credits (3-0-0)

Psychological testing: Uses and Varieties of Psychological Tests, Item Analysis, Norms and the Meaning of Tests Scores; Reliability and its Types; Validity and its Basic Concepts; Steps for Test Construction, Test adaptation and revalidation; Other Techniques of Behavioral Assessment; Ethical and Social Considerations in Testing; Ethical Guidelines in Behavioral Assessment.

HSL766 The Psychology of Leadership and Social Change

3 Credits (3-0-0)

The course will focus on: Great man and the cult of personality, Issues of context, contingency, transaction and transformation, Groups, social identity and leadership, Leadership as a group process, Prototypicality and leadership effectiveness, Gender and Leadership, Ethical leadership and Political leadership, A look at Followership, Leaders as entrepreneurs of identity and emotion, Can I be a leader? Understanding leadership as identity management. Leadership and transformation of social reality.

HSL767 Emotion and Decision making

3 Credits (3-0-0)

Pre-requisite(s): HSL661 (for MSc Cognitive Science students). For PhD (HSS, DMS and other dept.) with Instructor's approval.

The course is aimed at familiarizing students with concepts in affect and decision making and offer insight into ways in which affect processes influences decision making behavior.

HSL768 Judgment and Decision Making

3 Credits (3-0-0)

Pre-requisite(s): HSL661 (for M.Sc. Cognitive Science students). For Ph.D. (HuSS) or other Ph.D. students without backgrounds in psychology/cognitive science/management/design with the instructor's approval

On successful completion of this course, one should be able to demonstrate understanding about cognitive mechanisms in individual human judgments and decision-making under riskless and risky contexts. The course would also lead to enabling the students to link the findings to contemporary issues using the framework of behavioral economics and deliberate on possible directions.

HSL769 Number Cognition

4 Credits (3-0-2)

Pre-requisite(s): HSL661 (for MSc Cognitive Science students)

The course intends to introduce numbers as a cognitive entity and not as an abstract symbol as in mathematics. It will discuss how our minds process different representations of numbers and associated numerical information.

HUL771 Sociological Theory

3 Credits (3-0-0)

This is an advanced course that introduces students to a range of classical and contemporary sociological theory.

HSV771 Ethnographic Research Methods**1 Credits (1-0-0)**

This module introduces students to the theory and practice of ethnography. Issue of representation, objectivity and experience render challenges to the presumed 'objectivity' of social science research. The module engages with debates on ethnographic representation from the early development of anthropology through to feminist, postcolonial and postmodern critiques. It addresses questions of ethics and subjectivity in the conduct of ethnographic fieldwork especially in troubled times of violence or conflict. The module addresses conceptual issues of how to locate the 'field' as well as the practice of conducting ethnographic research through tools such as participant observation and life histories.

HUL772 Sociology of India**3 Credits (3-0-0)**

The major themes covered in this course include the debates on continuity and change in relation to colonial rule, ideas of tradition and modernity, models of development, agrarian structure and rural transformation, marriage and family, caste and kinship, secularism, Subaltern religion and religious conflict, class and social mobility. The course takes a critical and engaged perspective on concepts such as the village, family, caste, region, nation, language, religion, gender, class, development, tradition, indigeness, tribe, modernisation and others. Various approaches that have influenced the study of Indian society such as Orientalism, Indology, Structuralism, Structural-Function Subaltern Studies will also be discussed.

HUL773 Media, Culture and Society**3 Credits (3-0-0)**

The course examines contemporary manifestations of the 'media-event', the 'spectacle' and the fetishism of the image-object in determining the collective consciousness of our times. How are 'media-events' created? What is the role of the media (this includes mass media, advertisements, as well as social and digital media) in determining the nature of the 'self' and 'society'? How do media-trials alter the manner in which we relate to issues of justice and fairness? What is the manifestation of social movements in a media-saturated age? How do we recalibrate our understanding of privacy and what does this do to the ways in which we can create ever-changing and newer 'selves'? These questions will be examined through case studies from South Asia and beyond.

HUL774 Visual Methods in Social Research**3 Credits (3-0-0)**

The course analyses visual material in cross-cultural contexts and how the Internet in particular is being used to disseminate information and (re)present content. Importance of visual research methods; visuals as texts and framing; representing images and images in social research; Internet and online ethnography; analyzing websites - qualitative content; politics of digital culture.

HUL775 Agrarian Societies and Rural Development**3 Credits (3-0-0)**

Pre-requisite(s): For UG students: Any ONE course from HUL 271, HUL 272, HUL 275, HUL 281, HUL 286, HUL 371, HUL 372, HUL 375, HUL 376, HUL 377, HUL 378 OR HUL 380 OR any new 200 or 300 level Sociology course floated in future. For PG students: None

The course will introduce students to theories related to agriculture and development including modernization theory, the rational peasant, moral economy, the agrarian question, modes of production debates, peasantry as a class, etc. Readings from the history of agriculture in various countries including the United States, Asia, Africa and India will be taught in comparative perspective. The course will help students understand the economic, social, cultural, ecological, political dimensions to the agrarian question, especially in the light of urbanization and globalization over the last 150 years.

HUL776 Capitalism: Theory and Development**3 Credits (3-0-0)**

What is capitalism and how did it emerge? What are its strengths and weaknesses? How have the social scientists analyzed it and understood its implications for and relationship with other social phenomena? Addressing these questions, this course discusses the historical development of capitalist institutions and social relations in the context of the advanced industrial and developing societies. Particularly, it analyses the various theories and paradigms of capitalistic development, such as the Marxist political economy, classical liberalism, world systems theory, economic history and neo-liberalism. Furthermore, it analyses the relationship between the state and market, capitalism and liberal democracy, the religious roots of capitalism, social embeddedness of economic activity, and the 'new realities' of capitalism, such as displacement, inequality and rampant environmental degradation.

HUL777 Sociology of Science**3 Credits (3-0-0)**

Basic theories in the sociology of science such as functionalism, the theory of paradigm shift, social construction of scientific facts, stratification and discrimination in science, feminist epistemologies of science, theories of standardization and objectivity. Historical and contemporary debates on scientific and indigenous knowledge from India and the world, relationship between science and the state, and role of experts and the public in evaluating and regulating science.

HUL778 Urban Sociology**3 Credits (3-0-0)**

This seminar course critically examines the production of urban space and culture. The 'urban' denotes an aspect of physical space as much as a way of life and a mentality. A critical reading of ethnographic studies on the city provides a cross-cultural perspective on how space becomes culturally meaningful. The rise of the urban centre and metropolis are the product of a certain historical moment, yet they also produce distinctive mentalities and cultures that are unique to them. The course will explore the structuring and contestation of urban space through categories of class, ethnicity, status and gender and study the city as the location of discourses of and struggles for citizenship.

HUL779 Gender and Society**3 Credits (3-0-0)**

Sex and gender; masculinities, gender as performance and identity; sexuality and gender identities, masculinity and femininity. Hegemonic masculinity; Inter-sections of gender and race, ethnicity, caste and class. Institutionalization of gender via the state, family, marriage, religion etc.; the political economy of gender relating to reproduction, care, work and property. Issues of gender inequality, patriarchal oppression, violence, voice and agency.

HSL780 Social and Cultural Construction of Emotions**3 Credits (3-0-0)**

Pre-requisite(s): HSL661 (for MSc Cognitive Science students). This course will introduce theory and research on emotions, with a focus on the social and cultural underpinnings of mental processes that guide emotion appraisal, regulation and expression. We will draw on research in social, and cognitive psychology, as well as social and affective neuroscience and philosophy. Students in this class will be directly exposed to major theoretical debates and empirical developments in the emotion research. Discussion will range across multiple levels of analysis, from neuro-cognitive and physiological to the social and the cultural. Students will learn about the general aspects of emotions as well as the role of specific emotions such as anger, guilt, shame, humiliation, disgust and schadenfreude in social relations.

HUL782 Perspectives on Development in India**3 Credits (3-0-0)**

Pre-requisite(s): For UG students: ONE course out of (HUL 212, HUL 213, HUL 311, HUL 312, HUL 314, HUL 315, HUL 316, HUL 318, HUL 320 OR any new 200 level or 300 level Economics Courses floated in future) AND ONE course out of (HUL 271, HUL 272, HUL 275, HUL 281, HUL 286

This seminar course will undertake a critical examination of the

development process in India. The course introduces students to a historical overview of social, economic and political issues related to the ideas of development and growth. Starting from notions of improvement mooted under the colonial regime, to the processes of planning in independent India, the radical new agrarian policy of the 1960s and 70s, down to the era of liberalization in the 1990s and beyond, the course familiarises students with the political economy of development in India. It uses inter-disciplinary sources and texts to expose students to multiple ways of understanding and analyzing problems. Other topics covered include poverty and inequality, economics of discrimination (gender and caste) and the conflicts over land and natural resources in the 21st century.

HUL783 Science, Technology and Society

3 Credits (3-0-0)

Introduction to the discipline of Science and Technology Studies covering topics such as the technological determinism, social construction of technology (SCOT), actor-network theory, laboratory studies, scientific controversies, the theory of paradigm shift, social construction of knowledge, feminist theories of science and technology, the idea of technoscience, risk society, ethics in engineering, and the role of experts and the public in evaluating and regulating the production of science and technology.

HUL800 Research Writing

3 Credits (3-0-0)

The course will include aspects of writing composition and stylistics that are essential to write a coherent research paper/abstract. Topics will include text structure, common writing mistakes, ethical issues, etc. This will be a hands-on course; it will extensively use in-class exercises (as well as assignments) to help students learn the necessary skills.

HUL801 Law, Technology and Citizenship

3 Credits (3-0-0)

Although there has been considerable focus in political theory and legal studies on the concept of citizenship, and its relationship with the law, through the last six decades, the study of the importance of technology to this relationship is only an emerging field. Four performative sites of citizenship discourse/citizen action viz., (a) human rights approaches and the regulation of technology, (b) Surveillance state and citizenship, (c) Technological ethics as a site for citizenship discourse, and (d) Posthuman citizen, are focused upon to offer possible (conceptual and practical) implications for the ways in which 'law and technology' impacts existing rights discourse. Further, four important sites of contemporary debates on technology and citizenship, viz., UID/Aadhaar, Human DNA profiling for crime control, nuclear technology and genetically modified technologies in agriculture are focussed on to contextualise the key issues that are identified in the earlier modules.

HSL811 Advanced Economic Growth Theory

3 Credits (3-0-0)

Pre-requisite(s): For HES students (M.Sc. in Economics)--Completion of core courses. Not allowed to take this courses in the first year. For UG students--any ONE of: HUL212, HUL213, HUL311, HUL312, HUL211, HUL314, HUL318, HUL320

The course aims to develop an understanding of the process of economic growth and income distribution in an economy. Historical and contemporary experiences of countries on growth and developmental outcomes will be dealt with in this course. The impacts of capital accumulation, technological progress, and international trade on economic performance will be discussed. Further, this course will focus on how global capital movements, domestic institutions and political economy can affect economic growth and development.

HSL812 Advanced International Trade

3 Credits (3-0-0)

Pre-requisite(s): For HES students (M.Sc. in Economics)--Completion of core courses. Not allowed to take this courses in the first year. For UG students--any ONE of: HUL212, HUL213, HUL311, HUL312, HUL211, HUL314, HUL318, HUL320

The contents of this course will include topics such as - Ricardian and Heckscher-Ohlin models, their extension to many goods and factors, the role of tariffs, quotas, and other trade policies, trade under imperfect competition, outsourcing, political economy, multinationals, trade and growth, gravity equation, organization of the firms, etc.

HSL813 Foundations of Decision Theory

3 Credits (3-0-0)

Pre-requisite(s): For HES students (M.Sc. in Economics)--Completion of core courses. Not allowed to take this courses in the first year. For UG students--HUL212

The course aims to formalize microeconomic treatment of decision-making by economic agents. It will encompass consumer's choice problems, rationality theory and also bounded rationality theory. The course will conceptualize behavioural aspects of firm's decision-making- non-cooperation strategies and cartel formation would be discussed with respect to various market structures. Basic ideas of auction models would also be discussed and reference would be made to e-auctions and spectrum (or natural resource) auction markets. Latest developments in social and economic networks would be introduced and behavioural underpinnings would be discussed.

HUL814 Research Methods in Economics

2 Credits (1-0-2)

Pre-requisite(s): For M.Tech.: Any two of the following HUL712, HUL713, HUL714, HUL715, HUL716, HUL717, HUL718, HUL719, HUL720. For UG: Any two of the following: HUL311, HUL312, HUL314, HUL316, HUL318, HUL320, HUL712, HUL713, HUL714, HUL715, HUL716, HUL717, HUL718, HUL719

The course will cover theory and practice of doing applied research in economics, with special emphasis on primary and secondary data uses. The course will familiarize students with sampling techniques, questionnaire design, implementation of field-based studies, including randomized controlled trials. Students will be provided training in STATA for carrying out data analysis, including use of data sets such as the National Sample Survey, National Family Health Survey, Indian Human Development Survey. Students will be expected to design and implement a small study during the course of the semester and will be evaluated on this.

HSL815 Theory of Market Design

3 Credits (3-0-0)

Pre-requisite(s): For HES students (M.Sc. in Economics)--Completion of core courses. Not allowed to take this courses in the first year. For UG students--HUL212

This course primarily contains discussions on cooperative game theory, mechanism design and implementation theory.

HSL816 Game Theory

3 Credits (3-0-0)

Pre-requisite(s): For HES students (M.Sc. in Economics)--Completion of core courses. Not allowed to take this courses in the first year. For UG students--HUL212

The course formalizes the initial concepts of game theory, such as normal form games, existence, computation, extensive form games etc. After the introduction of these tools, economic examples in industrial organization and market design would be discussed in details.

HSL817 Health Economics

3 Credits (3-0-0)

Pre-requisite(s): For HES students (M.Sc. in Economics)--Completion of core courses. Not allowed to take this courses in the first year. For UG students--any ONE of: HUL212, HUL213, HUL311, HUL312, HUL211, HUL314, HUL318, HUL320

The course shall cover the role of health in economic development, measurement and determinants of health status, health as a consumption and investment good, the concept of health production function, the demand for health and health care, estimation of the demand for health, the supply of health, public and private

provisioning, health care financing, health insurance, and health policy. The focus of the course shall be on health outcomes and health care of the people in developing countries, specifically, India.

HSL818 Labour Economics

3 Credits (3-0-0)

Pre-requisite(s): For HES students (M.Sc. in Economics)-- Completion of core courses. Not allowed to take this courses in the first year. For UG students--any ONE of: HUL212, HUL213, HUL311, HUL312, HUL211, HUL314, HUL318, HUL320

In the first part of the course, we study neoclassical models of labour market and in the second part we introduce search theoretic models. The modules examine how workers, firms, and the government interact in the labour market. The focus here will be on the theories of wage determination, investment in human capital, labour market discrimination, and job search. The course content is based on recent research articles on these topics

HUL820 Advanced Topics in Economics

3 Credits (3-0-0)

Pre-requisite(s): For UG students-any ONE of: HUL211, HUL212, HUL213, HUL215, HUL311, HUL312, HUL314, HUL315, HUL318, HUL320

This course will introduce students to advanced topics in Economics as decided by the instructor.

HUL821 Performance/Theatre: Theory and Practice

3 Credits (3-0-0)

The course would introduce students to the theories of performance and a selection of the theatrical practices. Reading theatrical perspectives on the study of performances, alongside studying the development of theatre practices and the insights offered by various theatre practitioners would prepare the student for studying the performative.

HSL821 Eye Movement and Cognitive Processes

3 Credits (2-0-2)

Pre-requisite(s): HSL521

This course aims to highlight the link between various eye movements and the cognitive processes that subservise these tasks. On successful completion of this course, the student will be able to appreciate how measuring various eye movement patterns can give a peak into the cognitive processes such as vision, reading, language processing, attention, etc.

HSL822 Advanced Data Analysis for Behavioral Research Using R

4 Credits (3-0-2)

Pre-requisite(s): HSL722

The course assumes basic knowledge of R and data analysis techniques used in behavioral research. On the successful completion of this course, a student will be able to build onto that knowledge and use advanced analysis methods for handling various kinds of experimental data. In addition, the course will also expose the students to certain advanced topics/packages in R.

The course will comprise of 3 broad themes. In the 1st part of the course, we will introduce some advanced topics/packages in R. In the 2nd part, we will show how to use linear mixed-effect models from the perspective of frequentist statistics. The 3rd section will introduce the basics of Bayesian statistics and show how to fit hierarchical models from a bayesian perspective for data such as comprehension accuracy, reaction times, ratings, etc.

HUL823 Contemporary Critical Theory

3 Credits (2-1-0)

Recent developments in linguistics, philosophy and the social sciences; interdisciplinary cross-talk in these areas, concerning the status of canonical literary as well as marginal texts; feminist, post-modernist, post-colonial, subaltern, orientalist, new historicist, liberal Marxist and critical practice. The aim of the course is to familiarise students with

some of the vocabulary of theoretical inquiry today, so that they are enabled in their own research to question the verities which their disciplines seem to offer.

HUL831 Authorship and Copyright

3 Credits (3-0-0)

Pre-requisite(s): No prerequisite for Ph.D. For UG any ONE of the following: HUL331, HUL332, HUL333, HUL334, HUL335, HUL336, HUL338, HUL340, HUL351, HUL352, HUL353, HUL354, HUL355, HUL356, HUL357, HUL358, HUL359, HUL360, HUL375

The course would study the history of the print while keeping in perspective the changes in transmission of knowledge brought about by changes in technologies of representation – oral, manuscript, print. The coming of print is accompanied by the regulation of knowledge circulation by systems of profit. This amalgamation leads to the emergence of the idea of copyright which is further strengthened by the conceptualisation of the author as a genius. The course will study the prospects of the concepts of the author and copyright in the digital age.

HUL832 South Asian Writing

3 Credits (3-0-0)

The course will include discussions on the place of the English language and “imported” literary forms in South Asia, the fragmented and divided terrain of the South Asian city/nation, the figure of the expatriate writer, and the context within which to understand the stylistic and narrative aspects of this writing. It will undertake detailed analyses of the works of 3-4 writers, out of a longer list comprising Anita Desai, G V Desani, Salman Rushdie, Amitav Ghosh, Vikram Seth, Kiran Nagarkar, Aravind Adiga, Jeet Thayyil, Mohammed Hanif, Mohsin Hamid, Shyam Sevadurai, Romesh Guneseckhera, and others.

HUL833 The English Renaissance: Selfhood and Survival

3 Credits (3-0-0)

The idea of the Renaissance, the historical, political and social context The idea of the self and how it was conceived of during this period as different from previous notions The importance of the stage and theatre in Elizabethan England Shakespeare, Marlow and other dramatists Milton, John Donne and other poets.

HUL834 Literature and the City

3 Credits (3-0-0)

The course examines in some detail the nature of the challenge that traditionally preoccupied European writers - how to map the experience of the modern city, and what representational strategies were adequate for capturing the opacity, the fragmentation, and the transitory nature of urban modernity. It goes on to investigate the contemporary postcolonial city in order to understand it in relation to late capitalism, globalization, migration, and postmodern culture, and the challenges these pose to classic modernity. It begins by providing an introduction to some of the most important literature on the city and the major theoretical debates around it, offering students a set of conceptual tools with which to approach the city's incommensurable realities, its problems and its potential. It moves on to a detailed analysis of a number of literary texts, examining some of the ways in which the disjunctive realities of city-life shape new modes of experience, creative expression, and solidarity, without losing sight of the inequities of gender, culture, class, and race that persist and indeed strengthen in the current global economic system.

HUL835 Modern Indian Theatre

3 Credits (3-0-0)

History of modern Indian theatre through its relationship with colonial to post-colonial and nationalist concerns. Understanding the concept of modernity and its contested and changing forms in urban Indian theatre. Examining the trajectory of modern Indian theatre from the formation of institutions such as the National School of Drama as well as movements such as IPTA. The negotiation of modern theatre with its colonial and pre-colonial past – the Theatre of Roots. The impact and influence of the Parsi Theatre and the Marathi Sangeet Natak. Development and concerns of original English theatre in India. Studies of individual plays and playwrights within the aesthetic and political context of their productions.

HUL836 Performance/Theatre: Theory/Practice

3 Credits (3-0-0)

Pre-requisite(s): No Pre-requisite for Ph.D. for UG any one of the following: HUL333, HUL335

The course will look upon performance practices both within and beyond the theatre viz. the spectacular, the digital media, sports etc. It will take the students through a variety of performance practices and across the world. The history of the development of performance forms and conditions of performance would be studied. Special focus would be on the theorisation of theatre and performance both by theatre practitioners and those emanating from the area of Performance Studies. The role of performance in maintaining and countering relations of power would be explored. Students would be required to observe, study and analyse live performances as part of the course.

HUL840 Advanced Topics in Literature

3 Credits (3-0-0)

This course will introduce students to advanced topics in Literature as decided by the instructor.

HUL841 Minimalist Architecture of Grammar

3 Credits (3-0-0)

Pre-requisite(s): HUL 742: Transformational Theories of Language Or prior permission of the course co-ordinator

This is an advanced course in theoretical syntax and will benefit students interested in learning more about recent generative syntactic theories. There are two main objectives of the course: a) to provide the rationale for the 'Strong Minimalist Thesis: language as an optimal system'; and, b) to learn to generate syntactic structures using fewer transformations/operations and features and, with stronger economy considerations. On finishing the course, students will be familiar with both theoretical (substantive) aspects of the minimalist architecture of grammar, as well the technical (methodological) know-how of the system.

HUL842 Prosodic Morphology

3 Credits (2-0-2)

Pre-requisite(s): HUL 234, HUL242 and HUL 350 for UG

This course explores the connection between sounds and words. While the correlation between the meaning and sounds of a word are arbitrary, the string of sounds or phonological shape of words and other morphological units follow certain universal well-formedness principles. While many of these principles derive from the manner in which individual languages form rhythmic/prosodic domains in speech, some make crucial reference to morphological notions such as homonymy and synonymy. The aim of the course is to impart certain theoretical tools to analyze words from any natural language data. Since the objective of the course is to learn to analyze natural language data, it involves a substantial practical component.

HUL843 Reading and Sentence Processing

3 Credits (2-1-0)

The course content will cover state-of-the-art models of reading. The course will situate itself in the larger domain of sentence processing and address the important question of how reading and sentence processing are related. Distributed (SWIFT) as well as undistributed (EZ Reader) attention models will be discussed. Influence of low-level factors (eg. Word length, word frequency, etc) and contribution of high-level sentential factors on reading patterns will be introduced. Work on Indian languages will be discussed. Finally, models that integrate sentence processing and reading will be taken up.

[Note: Once an eyetracker is available, hands on sessions will be conducted to run simple reading experiments. See tutorial section for more details.

HSL844 Computational Models of Meaning

3 Credits (3-0-0)

Pre-requisite(s): HSL522, or a similar programming course, HUL242 or HSL541, HSL748

Models of word and sentence meaning are some of the most crucial elements for building intelligent systems for language understanding.

This course will cover the cognitive underpinnings of computational models of word similarity, ontologies such as WordNet and frameworks such as Abstract meaning Representation (for sentence meaning). The course will also examine applications of such models for carrying out natural language processing tasks.

HUL845 Environmental Ethics

3 Credits (3-0-0)

Objectives: To acquaint the student with (a) philosophical concepts underlying thinking about the environmental crisis and (b) the models of human-nature relationship found in some of the classical philosophical systems of India.

Contents: (a) What is 'environment'? (b) Conceptual basis for the split between 'nature' and 'culture' (c) Philosophical theories about the environment: Utilitarianism: Deep Ecology: Ecofeminism. (d) Non-humans as recipients of moral consideration (e) Environment and Gender (f) Environment and Development (g) The Third World perspective (h) Revisioning Ethics, Metaphysics and Epistemology in the light of the above debates.

HUL846 Philosophy and Film

3 Credits (3-0-0)

Nature of cinematic representation: Illusion, image, reality. **Perception of image:** Analytical, cognitive and phenomenological theories, **Interpretation of film:** meaning, authorship, Intention, Image and emotional response.

Film Theories: Classical theories: Eisenstein, Arnheim, Bazin, Pudovkin, Contemporary theories: Semiotics, Psychoanalysis, Marxism, Post-structuralism, Feminism, Auteur theory.

Aesthetics of Film: Cinema as art, entertainment and technology, Cinema's relationship with literature and other arts, Cinema and Digital Art, Aesthetics of interactive cinema, Aesthetics of special effects.

HUL850 Advanced Topics in Linguistics

3 Credits (3-0-0)

This course will introduce students to advanced topics in Linguistics as decided by the instructor.

HUL851 Philosophy of Literature

3 Credits (3-0-0)

The course examines the philosophical bases and problems that define key literary and literary-theoretical concepts, such as text, context, paratext, literary history, narration, meaning, interpretation, voice, style, literary specificity. Through the study texts of philosophy (both Anglo-American and European), literature and literary theory, which have influenced or responded to each other, the following topics and questions will be addressed: The ontological status of the text-context discontinuity; Through what concept of difference do we think the specificity of the literary? The epistemology of literature; Fictionality, Possible Worlds; Through what concept of existence do we distinguish literature from other phenomena, such as, hypotheses, lies, counterfactuals, dreams? Literature and/as Moral Philosophy; Is there a law of literature or does literature constitute legality itself? How does literature relate to non-literary, scientific, and everyday discourses? Life as Narrative and theories of narrative self; The relation between literature, aesthesis and reason; and emotional response to Fiction.

HUL852 Political Philosophy

3 Credits (3-0-0)

This course will introduce students to key concepts and theories in political philosophy, such as justice, democracy, citizenship, secularism, sovereignty, equality, rights, and freedom. The approach will sometimes be historical, involving an intense engagement with the work of a particular thinker or philosophical tradition; at other times it will be thematic, taking up a particular notion such as secularism and addressing it from many different points of view. The emphasis will be on a close and rigorous reading of these texts, while also addressing questions about their contemporary relevance. The lecture outline is for ONE possible course on key texts in the Western liberal tradition.

HUL853 Art and Aesthetics

3 Credits (3-0-0)

• Aesthetic Attitude and Aesthetic Experience • The Ontology of Art:

on what kind of a thing is a work of art • Theories of Art: Resemblance, Representation, Expression and Form • Aesthetic Judgement: Perception and Imagination; The Sublime and the Beautiful • Emotional Response to Fiction • Criticism and Interpretation: on whether critical-interpretative canons are fixed or open-ended • Art, Tradition and Modernity • Art, Morality and Politics: Art as Ideology • Metaphor, Narrative and Fictionality • Philosophy and Literature: on Literature as Cognitive Thought-Experiment about Human Possibility

HUL854 Problems in Metaphysics

3 Credits (3-0-0)

Ontological issues concerning God or Necessary Being, Mind, Self and Personal Identity, Universals and Particulars, Primary and Secondary Qualities, and Fictional Objects. Understanding the place of Mind in the Natural World, the distinction between Being-in-itself and Being-for-itself, Agency and Freedom, Subjective and Objective, Consciousness and Self-Consciousness, and the notion of Inter-subjectivity. Special study on the conceptualization of reality in terms of Phenomena and Noumena will form an important part of the course.

HUL856 Philosophy of Language

3 Credits (3-0-0)

The course is a study of four major topics: Reference and Descriptions; Truth and Meaning; Pragmatics and Speech Acts; Language and Metaphor. The course covers analyses of the following specific concepts: Sense, Reference, Descriptions, Proper Names, Natural Kind Terms, Truth, Intentional semantics, Communicative Utterances; Figurative Speech.

HUL857 Epistemology

3 Credits (3-0-0)

Necessary and Sufficient conditions of Knowledge and the Gettier Problem. Theories of Epistemic Justification: Evidentialism and Reliabilism; Internalism and Externalism; Foundationalism and Coherentism. Scepticism: Philosophical Scepticism and Ordinary Incredulity; Semantic Contextualism and Inferential Contextualism. Social Epistemology: Epistemology and Collective Doxastic Agency; Epistemology of Testimony. Virtue Epistemology: Knowledge and Intellectual Virtues; Epistemic Values. Feminist Epistemology: Critique of Rationality and Gender Duality; Feminist Epistemology of Science; Feminist Naturalized Epistemology: Standpoint Theory.

HUL860 Advanced Topics in Philosophy

3 Credits (3-0-0)

This course will introduce students to advanced topics in Philosophy as decided by the instructor.

HUL861 Psychology of Decision Making

3 Credits (3-0-0)

The course will cover topics on psychological constructs affecting decision making (e.g., IQ, memory, motivation, emotion), decision-making processes (e.g., information search, risk perception), decision-making contexts (e.g., constraints, culture), and applications of behavioral decision making related to consumption (e.g., environment, technology, consumer decision making).

HUL862 Special Module in Cognitive Psychology

3 Credits (2-0-2)

The course will cover brief history of cognitive psychology, approaches, theoretical frameworks, and current issues in cognitive psychology.

HUL863 Emotion and Cognition

3 Credits (3-0-0)

The course will cover the following topics: theoretical approaches to emotion (evolutionary, biological, social, cognitive), select emotions and emotion expression (e.g., anger, fear, sadness, joy, surprise, disgust), and implications of emotion and cognition (e.g., stress-health, sex-differences)

HUL870 Advanced Topics in Psychology

3 Credits (3-0-0)

This course will introduce students to advanced topics in Policy Studies as decided by the instructor.

HUL871 Ethnographic Perspectives on the State

3 Credits (3-0-0)

Traditionally studied by political scientists, the state has increasingly come to be regarded as an object of anthropological study. Ethnographic perspectives on the state seek to open up the state to critical scrutiny, dislodging it as a monolithic conceptual or territorial apparatus. These studies allow us to think of the state beyond governmentality or bureaucracy, to engaging with the multiple ways in which state 'effects' shape our engagement with it. How does the 'idea' of the state constrain the way in which we 'think' the state? What are the ethnographic sites through which the state emerges as an object of study, e.g., bureaucracy, law, sexuality, marriage, citizenship, borders etc? The course will consist of seminars designed around a set of readings, which will be discussed in detail each week.

HUL872 Sexuality, Governmentality, and the State

3 Credits (3-0-0)

Sexual governance or state surveillance of issues pertaining to sexuality, marriage and mobility highlight the problematic division between the 'public' and the 'private'. The 'intimate' sphere is no longer one that is outside the purview of states; indeed the 'private' or the 'intimate' is often co-produced as a corollary of the public face of a state's legitimacy. Nationalism and patriotism are heavily grounded in issues pertaining to culture and sexuality, often thought of as 'private'. This course will provide a historical and sociological perspective to how sexual governance – the control of women's sexuality, conjugality and the definition of 'marriage' and the 'family' by a patriarchal state shows that the state has always concerned itself with the intimate lives of its citizens.

HUL873 Language, Culture and Society

3 Credits (3-0-0)

What is language? How does it relate to the 'collective consciousness' of a society? How does language relate to ideology and when does language become 'linguistic capital'? This course introduces students to some theoretical approaches to the study of language in social anthropology, such as structuralism and Marxism. This will be followed by studies of language movements, language policy in colonial and postcolonial India. The course concludes with questions of 'free speech', 'hate speech' and some debates on censorship.

HUL874 Civil Society and Democracy in India

3 Credits (3-0-0)

This is a post-graduate level seminar based course. The objective of this course is to discuss the complex and contingent relationships between state, market and civil society in India and examine the implications of their relationships for the broader processes of development, democratization, citizenship rights and governance in India. The course begins with an overview of the classical and modern theories of the state and civil society. Students read Hobbes, Locke, Hegel, Marx, Gramsci, Tocqueville and other political theorists. The course will then focus on the role that civil society has played in Indian development and democracy. The course will discuss topics such as civil society and political society, NGO-ization, non-party political processes, social capital and ethnic conflict, economic roots of civil society and participatory development and democratization.

HUL875 Ethnic Identity, Development and Democratization in North-east India

3 Credits (3-0-0)

Making of Northeast India (NEI) – past and present; Regional identity and Nationalism; Look East policy and Vision 2020; Identity politics, ethnic affirmation, territorial sovereignty and ethnic violence; underdevelopment and development challenges; social movements, ethnic movements for political autonomy and secessionism; responses of Indian state and AFSPA; gender, tribalism, race, and religion; civil society in NEI; human development report.

HUL877 Industry and Society

3 Credits (3-0-0)

The course material will include the following topics: evolution of industrial society, industry and industrialization, class and work

in modern industrial societies, alienation and embourgeoisement, labour management relations and labour reforms, family in industrial society, formal and informal sector, technology and new economy, industry, industrial resources and new social movement, post-industrial society.

HUL878 Globalization

3 Credits (3-0-0)

Globalization and Globalism; Economic Globalization and Neo-Liberalism; Political Globalization; Social and Cultural Globalization; Civil Society and International Politics; Anti-Globalization.

HUL879 Political Ecology as a Development Critique

3 Credits (3-0-0)

Questions of conflict over natural resources, the conservation of biodiversity under market environmentalism, the political ecology of farming and industry, the emergence of environmental movements, the political ecology of indigenous people, feminist political ecology, urban ecology, environmental justice, and degrowth comprise core concerns of this course. The influence of globalization and neo-liberalism provides a rich context to understand these contestations and conflict over resource distribution. These propel the debates on ecological utopias. Case Studies include (any two per semester): forestry; industry and mining; body and health; climate change; water; political ecology of tribal areas of India.

HUL880 Advanced Topics in Sociology

3 Credits (3-0-0)

This course will introduce students to advanced topics in Sociology as decided by the instructor.

HUL881 Narratology: Foundations, Domains, Frontiers

3 Credits (3-0-0)

The course will familiarise students with the beginnings of this field of study in Russian formalism, structural linguistics and anthropology, and then its entry into literary studies, discourse and stylistics. The course will trace the development of narratological concepts (e.g. fabula/sujet, narrative voice, focalisation, paratext metalepsis, unreliability, free indirect speech, orientation, evaluation, coda etc.) within schools of thought since the 1970s on. It will visit the debates on narrativity and gender, race, history, ideology, culture and cognition. The spread of narrative theory beyond literary works to other areas such as comic books and video games, as well as its relevance to other disciplinary inquiries in sociology, legal studies, political theory, postcolonial theory and psychology will be discussed. The course will consider the philosophical questions of narrative and temporality, anti-narrative, subjectivity, language, action, personhood, framing, closure and evolutionary theory.

HUL882 CyberPower and Cyber-Protest

3 Credits (3-0-0)

Network Society and the Internet, Cyberspace and the Virtual Individual; ICT Outreach, Social Inclusion, and Digital Divide in Developing countries; Digital Democracy and the Online Public Sphere; Cyberpower, and Cyberpolitics; Smart mobs; Cyberprotest; Case Studies

HUL883 History and Revolution

3 Credits (3-0-0)

The course will study major concepts of historicity and revolution in order to examine the role played by revolution in bringing or blocking historical change, in breaking with certain social and intellectual patterns. It will respond to questions about the nature of the pre-revolutionary moment emergent within existing historical situations and yet departing from them; the designation of selective historical moments as revolutionary; the variety of domains beyond the narrowly defined domain of politics that have seen revolution, for instance, in science, technology, social relations, and philosophy. With respect to political revolutions, how is a revolution in history analysed, and what happens to sovereignty? What is the role of violence in revolution as compared to other categories of history (period, epoch), and how does it affect language itself, both of literary representations of revolution and of historiography?

HUL884 Environmental Ethics

3 Credits (3-0-0)

Pre-requisite(s): HUL275

The course introduces different understandings about categories of 'environment' and 'environmentalism' that have emerged in contemporary thought, and its implications to its study in within an ethics framework. It seeks to explore three tropes. First, is a foray into the nature-culture debate, a debate central to environmental ethics. It seeks to lay the basis for the field by tracing key texts in the debate, viz., how the category of 'nature' is understood to be something which is external to humans. Second, we seek to understand the ways in which the 'crisis' in environment is constructed, a crisis which then would require certain ethical approaches to amelioration of our relationship with our surroundings. Third, is an exploration of specific themes in the field of contemporary environmental ethics - critical environmental aesthetics, applied ethics in agriculture, and explore ethical frameworks from non Western realms like in the Indic context, and Buddhist environmental ethics. This course looks at the imperatives and politics that shaped the literatures and discourses that shaped environmental ethics as a distinct discipline.

HUL885 Criticism, Crisis and Critique

3 Credits (3-0-0)

In this course we will inquire into some or all of the following questions pertaining to the relation between criticism, crisis, critique and critical theory: a) the development of criticism as a part of the literary as well as philosophical inquiries into morals and tastes from antiquity to the present; b) the manner in which the development of the idea of critique in the context of the crisis that accompanied 18th century "Enlightenment", the rise of the public sphere, and colonialism; c) the relation of criticism and critique to literature and to metaphysical inquiry; d) the concepts and concerns that inform theoretical and critical activity today, i.e., the critiques of gender, religion, race and caste; e) the relation of critical theory to critical practice, e.g. application, evaluation, description, self-reflexivity, and resistance, as observed in various schools of literary theory and criticism.

HUL886 American Fiction II

3 Credits (3-0-0)

This is a survey course covering American fiction of the post- World War-I period. Some of the major novelists of the period will be studied, including Hemingway, Scott Fitzgerald, Steinbeck, Richard Wright, Ralph Ellison, Saul Bellow, Bernard Malamud, John Barth, John Updike.

HUL888 Applied Linguistics

3 Credits (3-0-0)

Notions of applied linguistics; psycholinguistics; socio-linguistics; language learning; language teaching; contrastive analysis; error analysis; pedagogic grammars; applied lexicology; communicative teaching; discourse analysis; stylistic and literature.

HUL889 British Fiction – A Stylistics Approach

3 Credits (3-0-0)

Language in prose and poetry; stylistics; deviance; prominence, foregrounding; literary relevance; stylistic variants; language and the fictional world; the rhetoric of text; discourse situation; conversation, speech and thought.

HUL891 Globalization and Transnationalism

3 Credits (2-1-0)

Globalization & Globalism, Nationalism & Transnationalism, Dicapora, Glocality. Globalisation and Transnational movements of people, ideas & technology, culture, capital and goods. Relationship between locality, national boundaries and transnationalism personal and collective identity. Transnational migration and global politics of gender and work in a global world- Dicapora. Religion and Ethnicity in a global world. The State and Democracy in a globalised world.

HUL893 Literature and the City

The course examines in some detail the nature of the challenge

that traditionally preoccupied European writers - how to map the experience of the modern city, and what representational strategies were adequate for capturing the opacity, the fragmentation, and the transitory nature of urban modernity. It goes on to investigate the contemporary postcolonial city in order to understand it in relation to late capitalism, globalization, migration, and postmodern culture, and the challenges these pose to classic modernity. It begins by providing an introduction to some of the most important literature on the city and the major theoretical debates around it, offering students a set of conceptual tools with which to approach the city's incommensurable realities, its problems and its potential. It moves on to a detailed analysis of a number of literary texts, examining some of the ways in which the disjunctive realities of city-life shape new modes of experience, creative expression, and solidarity, without losing sight of the inequities of gender, culture, class, and race that persist and indeed strengthen in the current global economic system.

HUP102 Research Participation

1 Credits (0-0-1)

This course will expose students to various experimental methodologies in sub-fields of Psychology and Psycho/Cognitive-linguistics. These will be behavioral experiments that will investigate theoretical questions (e.g., psychological questions related to perception, attention, emotion, choice behavior; psycho-linguistic questions related to sentence comprehension, sentence production, memory, attention, language-perception interaction). The course will illustrate ways in which theoretical/practical research query pertaining to human cognition is translated into a testable problem with the help of widely used behavioral methods.

HUV731 Critical Reading

1 Credits (1-0-0)

The course will introduce students to the tools of critical analysis of a variety of verbal texts – poetry, short stories, essays, non-fiction and academic writing. It will require students to study basic semiotics, and critical terms and study a variety of texts prescribed for the course.

HUV734 Dimensions of Language

1 Credits (1-0-0)

The course will provide a brief overview of the important contributions to the study of language, its origins, diversity, and its metaphysical, historical and political dimensions in order to attend to the multiple levels at which literature plays with and transforms language on the one hand, and is conditioned by on the other. A range of readings will be used to focus on: the relation between language use and a particular historical and social situation, and the work of literature in defining this relation; the politics of language with respect to state, religion, nation, gender and caste; subjectivity in language; metaphor and metonymy, literary stylistics and rhetoric; agrammaticality.

HUV735 Narrative Matters

1 Credits (1-0-0)

The course will acquaint students with the distinctions of formal and conversational, fictional and non-fictional narratives. Students will acquire the training to think about and conduct research on discourse by going beyond the story and plot and considering discourses in terms of salient narrative features such as narration, author, reception, motivation, tradition, and framing. The politics of culture, representation and the working of power can be better analysed with a mind to the role of narrative in action, communication and signification.

HUV747 Data-driven Analysis and Tools for Linguistic research

2 Credits (2-0-0)

Pre-requisite(s): HUL 242 for UG

The course will cover the following topics: (1) Quick introduction to Python (2) It will give a broad overview of how one can use natural language text for making linguistic generalization and discovering

linguistics patterns, (3) We will also look at how the data can be used to make automatic tools such as taggers and parsers. In the process we will learn to use the following resources/tools: (a) NLTK (b) MaltParser (c) WordNet.

HUV748 Data Analysis for Psycholinguistics using R

2 Credits (2-0-0)

Pre-requisite(s): HUL 242 and HUL 381 for UG

The course will comprise of 4 broad themes. In the 1st part of the course we will introduce the basics of R. R syntax and its libraries will be extensively used for other parts of the course. In the 2nd part we will introduce basics of statistics that are needed for understanding ideas of frequentist-based hypothesis testing methods. We will then move on to linear regression which will form the background using which we introduce linear-mixed models in the final section of the course. The course will also provide assignments and projects where the students can practice the course content and apply the learnt concepts to real experimental data.

HUV773 Tools for Sociological Research

1.5 Credits (1.5-0-0)

In this course, the students will be introduced to mixed methods research (quantitative and qualitative). They will be familiarized with specific modes of observation such as surveys, focus group discussions, interviews, and participatory rural appraisal, followed by designing specific tools of data collection such as questionnaires and interview protocols for different modes of observation. Special emphasis will be given to household surveys and data from large surveys such as census, NFHS, NSS, migration and urban surveys. This will be followed by elementary data analysis techniques and inferential statistics, converting qualitative data into quantitative data and the use of qualitative data analysis software.

HUV774 Methods in Historical Sociology

1.5 Credits (1.5-0-0)

As sociologists increasingly turn to the past for an understanding of the present, the discipline has incorporated methods from historical research. These include debates on what constitutes an archive, the production of the past as an exercise of power, and how to read historical sources in an ethnographic vein. The significance of the 'fragment' or documentary evidence for ethnographic research will be considered. This module will introduce students to some of these larger methodological and theoretical debates from history and sociology.

HUV781 Introduction to Research Methods

1.5 Credits (1.5-0-0)

This course will begin with introducing students to different paradigms of inquiry and research with implications for methodology. It will then provide an overview of how to formulate research questions and hypotheses, identify unit of analysis, conceptualize and operationalize variables of interest. The students will be familiarized with random and non-random methods of sampling. The discourse on research ethics will be an integral part of most discussions in this course.

HUV886 Special Module in Cognitive Psychology

2 Credits (1-0-2)

The course will focus on current relevant and emerging issues, and experiments in the field of cognitive psychology.

HUV887 Special Module on Econometric Tools

1 Credits (1-0-0)

Pre-requisite(s): HUL or SML 700/800 category courses

Estimation and inference in two variable model; OLS assumption; Extension of the two variable model; OLS assumption : autocorrelation, multicollinearity, and heteroskedasticity, models with limited dependent variables : LPM, logit, and probit; Panel data modelling : fixed effect and random effect models; Time series analysis: introduction to non-stationarity, AR and MA modelling.

Department of Management Studies

MSL301 Organization & People Management

3 Credits (3-0-0)

Lectures on multidisciplinary perspective on organizations, Organizational structure & Design, Organizational stakeholder Ethics, Organizational Culture, Organizational Environment, Strategy and Structure, Technology and organizational structures, Lifecycle of an organization will be supported with case studies & exercises.

MSL302 Managerial Accounting & Financial Management

3 Credits (3-0-0)

On completion of this course the student will be able to: Understand accounting for managerial decisions. Assess financial health of a corporate firm. Design profit planning. Understand cost concepts and financial decision making.

MSL303 Marketing Management

3 Credits (3-0-0)

Marketing concept, Environment of Marketing, Marketing Strategy, Marketing Ethics, Marketing Planning, Concept of Product life cycle, Pricing, Advertising and Promotion Strategies, Concept of Unique selling proposition, Product and Brand Management, Marketing Research Methodologies, Case study discussions.

MSL304 Managing Operations

3 Credits (3-0-0)

The objective of the course is to provide the students about the application of Industrial management in various functional areas of business especially industrial operations such as linear programming, assignment and transportation problem, layout/location design, quality, materials management, Preventive maintenance, project management, supply chain management, scheduling/sequencing, ergonomics, operations strategy. The entire course is a case based where the participants will be given a case. Participants will be asked to tackle the case problem without using linear programming techniques.

MSL305 New Venture Creation

3 Credits (2-0-2)

New Venture Definition, Venture challenges and preparedness, History of Enterprise, Modern Firm as an Enterprise, New Enterprise and Technology Development, Technology Enabled Venture, Innovation and Problem-ambiguity, Innovation and Risk-taking, Self-discovery, Aspiration Mapping, Founder Leadership, Values for Implementing Vision, Entrepreneurial competency awareness, Entrepreneurial Mindset, Entrepreneurial Strategic Orientation, Commitment to Opportunity, Commitment to Resources, Early Stage Resource Control, Management Structure for Entrepreneurial Culture, Entrepreneurial Mindset on Compensation/Reward Policy, Articulating Entrepreneurial Strategies, Ideation & venture development, Intrapreneurship vs Entrepreneurship, Internal Venturing.

Opportunity Sensing, Sustainable & Empathetic Entrepreneurial Design, Entrepreneurial Resourcefulness, Early Stage Organisation Building, Venture Evangelising, Marketing and Business Development.

MSL306 Ideation & Prototyping

3 Credits (3-0-0)

Module I: Framework for changing environment, Criteria and perimeter definition for relevance, Idea potential Recognition, Incorporating environmental factors into idea development, Venture life cycle of ideation, planning, implementation, Understanding socio-cultural, politico-legal & economic dimensions of the environment, opportunities and challenges, Macroeconomic indicators relevant to an idea, Demand estimation for emerging market, Policy regime changes and opportunities, Global Economic Environment impact on Indian markets, Changing Social Paradigms & Evolving Technology.

Module II: Understanding consumer behaviour as a prerequisite for marketing plan and strategy, Consumer discovery: Consumer location, Market analytics, Psychographic and demographic profile, Income levels, geography and culture); Product knowledge and involvement;

Reasons for the purchase; Decision making process of the consumer, Pain points of potential consumer. Pricing, Product features, Service quality, Delivery, Consumer need analysis, Consumer's environment (Physical and social), Cultural influences, Family influence, Family decision making, Demographic changes in family, Consumer socialisation.

Module III: Ideation Process, Creative thinking, Individual vs. group creativity, Tools and techniques for creativity, Creativity Management, Evaluation of creativity methods, Fostering a creative working environment, Organizing to allow and assist creativity, Creativity and idea generation. Challenging assumptions, Ideation as personal journey and purpose-oriented way of life, Leading change, Idea in the context of environmental dynamics, Idea to lead change, Ideation Framework, Ideation as process and a way of life, Tools for Ideation, Context for idea generation, Approach to generation of ideas, Techniques to generate ideas, ideation process, idea repository.

Module IV: Prototyping, Cycle time of development, Product Development Process, Identifying Customer Needs, Product Planning, Product Specifications and Concept Generation, Prototyping, Concept Selection and testing, Peer Concept Review, Product Architecture, Industrial Design, Design for Environment, Design for Manufacturing, Time to manufacture, Early Demand Forecasting for New Products, Product development economics.

MSL307 Venture Financing & Teaming

3 Credits (3-0-0)

Pre-requisite(s): MSL305, MSL306

Module I: Early Stage venture financial sourcing and utilization, Art of Bootstrapping: Emphasize the significance, switch to external funding.

Module II: Process, options and strategy of acquiring resources
Module III: Attracting Investment at early stage: Dwell on idea communication, trust building and sourcing of early investors into the venture along with comparative evaluation of early investment opportunities.

Module IV: Early Stage Valuation Models, tools of financial valuation. The role of valuation in investment decisions faced by entrepreneurs and investors.

Module V: Art and science of utilizing and managing resources.

Module VI: Team Synergy and Engagement Terms: Challenges, long-term payoffs of high-performance synergized teaming. an early stage venture. Real-world case studies on entrepreneurial finance.

MSD308 Product Viability & Market Traction

1.5 Credits (0-0-3)

Pre-requisite(s): MSL305, MSL306, MSL307

Business Model concept, Emerging Business Models, Lean Business Modelling, Business Model Innovation & Design, Value Proposition, Market Analysis, Market Sensing, Understanding consumer perception and behaviour, Knowing market dynamics, Competitive Advantage, Willingness to Pay.

Qualitative & Secondary Market Research methods for startups, Target segment identification, Demand analysis and forecasting, Market Strategy and Marketing Plan, Go-To-Market process, Building Marketing & Sales teams, Business Development, Brand building and Brand Communication, Minimum Viable Product (MVP).

MSD309 Business Plan & Funding

1.5 Credits (0-0-3)

Pre-requisite(s): MSL305, MSL306, MSL307, MSD308

Business Planning & Assumptions, Growth Projection, Realistic Cost estimation, Revisiting/Critiquing 'State of the Venture', Cost monitoring and Management techniques, Products/services pricing techniques, Revenue projections, Financial Analysis and ratios, Effective communication for funding, Business Presentation Components Venture Pitching, Organising venture Information for presentation Fund Sourcing Strategy, Fund Usage, Optimal usage of investment funds, Planning & Preparing for Scaling Venture Scaling. Fund Usage, Scaling issues, Budget preparation, Detailed planning for business operations, Business monitoring and performance metrics.

MSL310 Financial Institutions and Markets*3 credit (3-0-0)*

Introduction to the financial markets including debt, equity, derivative, and foreign exchange markets, various types of securities issued and traded in these markets, why these securities are issued, what are the risks associated with these securities, and how these risks are managed. This course also covers roles played by different financial institutions in an economy and regulatory framework surrounding financial markets.

MSL401 Entrepreneurial Design Thinking*3 Credits (3-0-0)*

Designing to Needs, Problem Framing and Problem Finding, Techniques of Brainstorming and Idea Generation, Innovative Problem Solving, Design Thinking process, Mind mapping, Nominal Group Techniques, Reversal Techniques, Rotating Attention, Lateral Thinking, Forced Relationships, Use of Analogies, Attribute Analysis, Visual thinking, Entrepreneurial Design Thinking, Human Centred Design, Impacting Lives to Promote Innovation.

Understanding of Materials, Forms Shaping, Processes of Prototyping, Experimenting and Iterating, Process of Creating New Options, Design and Society, Global Impact of Design, Design Thinking for Global Impact, Balancing Process of Design, Ethical Implications of Design, Leading the Founding Team, Values for Implementing Vision, Forming Design Team, Design Based Customer Needs Identification, Understanding Product Architecture, Financial Analysis, Designing for Environment and Sustainability.

MSL402 Social Innovation & Entrepreneurship*3 Credits (3-0-0)*

Social Entrepreneur Definition, Social Entrepreneurship Preparedness and Capabilities, Social Problem Sources, Social Opportunity Identification, Changing Social Problems/Liabilities into Enterprise Opportunities, Societal Value Creation Process, Measuring Social Impact Social Venture Concept, Establishing a Viable and Growing Enterprise, Legal Framework for Social Enterprise Formation, Social Asset Building, Income Generation for a Social Enterprise, Financial Structures for Social Ventures, Income Models and Revenue Strategy for Social Venture, Transferring Financial Models to New Social Context, Team Building & Alignment.

Social Business Model Canvas for Planning Social Venture, Social Innovation Planning, Business Model Design for Social Enterprise, Scaling Social Venture Impact. Business Plan for Social Mission, Emerging Organisational Forms for Social Enterprise, Funding Strategy for Social Venture, Social Impact Investment, Pitching for Social Funding/Grants, Communication Strategy of Social Enterprises, Marketing to Social Beneficiaries.

Growth of Social Enterprises, Replicating Social Innovation, International Growth Strategies to Scale/Replicate Business Model, Organic Growth, Social Franchising, Open Source Approach, Exit Strategies for Social Ventures, Extracting Value from Failed Social Ventures.

MSL403 Entrepreneurial Market Strategies*3 Credits (3-0-0)*

Process & Discipline of Market Sensing, Value Proposition for Relevant Stakeholders, Go to Market (GTM), Developing Profitable Core Product Design.

Branding Essentials, Target Market Identification. Market Communications Objectives, Creating Brands, Scope of Branding, Brand Positioning and Differentiation, Brand Positioning Statement, Engaging Brand Professionals, Creating Brand Portfolio, Choosing Brand Elements, Branding Activities & Execution Plan Design, Assessing Brand Readiness, Communication System Design for Repeat Business and Scaling, Correlation with Branding, Communicating Value Proposition,, Stakeholder and Potential Customer Feedback, PR Engagement, Advertising Budget for Startups, Advertising Campaign Design, Communication Channel Selection, Social Media & Digital Marketing Managing Personal Communications.

Distribution Channel Decisions, Sales Planning & Execution & Installing Processes, Systems for Sales Productivity, Sales Force Recruitment

and Training, Sales Script Design for Direct Marketing, Cold Calling, Closing Sales Deal, Managing Sales Process.

Post Customer Acquisition, Handing New businesses to Internal Processes, New Opportunities from Known Accounts, Consumer Grievances, Win/Loss Review, Process Modification for Value Proposition, Innovation/Continuous improvement of installed GTM Flow.

MSL404 Entrepreneurial Business Development*3 Credits (3-0-0)*

Building and Managing Core Business Relationships, Managing Core Relationship, Internal and External Stakeholders of B2B, B2C, and B2B2C Setup, BD for Predictable Business Cycles.

Creating Business Development Process, Business Development Stakeholder Incentive, Building Continuous Improvement Processes, Stakeholder Identification and Development Framework, Six Degrees of Separation, Art of Networking, Internalizing Intangible Aspects of Relationships, Systemic Culture, Adapting to Stakeholders' Cultures, Importance of Values, Strategies around Legal, Moral, Geo-Political Issues, Understanding and Optimal Usage of Methodologies.

Role of Technology in Building and Managing Core Relationships. Tech-enabled Systems for Building and Managing Core Relationships (CRM), Productivity Tools to Manage Core Relations. ERP Tools for Startups and Mid-Size Companies, Social Media Usage to Move Strategic Agenda, Consistency in Personal Integrity, Principles, Morals and Obligations, Art of De-learning, Relearning and Applying New Skills, Harvesting Assets in Perpetuity, Framing Existing Relationships and Linkages.

MSL405 Financial Accounting & Compliance for Startups*3 Credits (3-0-0)*

Expense Accounting, Levels of Profit Depreciation, Interest Accounting, Taxes, Appropriations, Understanding Financial Statements – Balance Sheet, Accounting for Fixed Assets, Current Assets (Inventory), Liabilities accounting, Working Capital, Understanding Financial Statements – Cash Flows, CF for Financial Health, Financial Statement Analysis, Linkage between IS, BS and CF, Horizontal and Vertical Analysis, Comparison with peer group and industry, Tax related compliances, GST for Startups, Income Tax for Startups, Sensitization of Limitations of Accounting Statements, New Venture Working Capital Management, Sources and Drivers of Firm Value, Negotiation with Angels/VC, Structuring the deal with Angels/VC, Tools & Models of Financial Valuation, Role of Valuation in Investment, Financial Models and Analysis, Opportunity Cost of Capital, Entrepreneurial Finance, Sources of finance for Startups, Security Design and contracting Venture capital Cycle, Monitoring and Advising Corporate Venturing, International Perspectives on Venture Capital Finance. Real-world Case Studies.

MSL406 Company Law, Governance, IPR & Legal Issues for Startups*3 Credits (3-0-0)*

Navigate Relevant Legal System. Legal Aspects of Forming & Structuring Companies, Incorporation Strategies), Forms of Incorporation, Sole proprietorship. Partnership, Limited Liability Company, Private limited company, Social Enterprise Incorporation, Registration and due diligence, Tax implications of Enterprise Form, Founders' Equity arrangements, Contract Act, Startup Employment Issues - Non-disclosure Agreement, Direct Taxes on Startup Compensation Structure, Tax Efficient Compensation Structure, Sweat Equity/ESOPs, Intellectual Property Rights (IPR), Time & Process of Patenting, Idea Disclosure, Legal protection for IPR violation, Consumer protection, Indirect Taxes and Impact on Business, Service tax Compliance and Impact, Legal issues (Incorporation, IPO, Due diligence Stock Exchange Listing, Privacy Policy and Terms of Use, Legal Aspects of Investment, Frequent Legal Oversight & Mistakes, Oral Contract Enforceability, Insolvency & Bankruptcy, Managing Legal Claims by a Low Performing Startup.

MSL407 Corporate Innovation & Entrepreneurship*3 Credits (3-0-0)*

Intrapreneurship Concept, Intrapreneurship & Entrepreneurship Distinction, Corporate Experiences in Intrapreneurship, Intrapreneurial

initiatives in Matured Organizations, Sensing Emerging Corporate Opportunities, Corporate Learning from Intrapreneurial Initiatives Failures, Intrapreneurial Strategies, Cross-Functional Teams for Intrapreneurship, Corporate Innovation, Innovation and Intrapreneurship, Growth Stagnation in Successful Firms, Sources of Organisational Rigidity, Organisational Fatigue in Market Response, Rekindling 'innovation', New Business Creation, Measuring/Tracking Intrapreneurship, Channeling organisational resources for intrapreneurship, Intrapreneurial Environment to Sustain Initiatives, Processes for Overcoming Organizational Inertia.

Implementing Intrapreneurial Changes, Challenges Implementing Initiatives, Resolving Implementation Challenges, Intrapreneurial Leadership, Intrapreneurial Talent Recruitment, Lateral Entrepreneurial Potential, Entrepreneurial Team Building Strategies, Cross-Functional Team Effectiveness, Methodologies for Group Dynamics, Decision Making, Power, and Conflict in Intrapreneurial Teams.

Innovative Networks Idea Sourcing, Key Individuals and Organisations in External Environment, Internal Venturing, In-house Incubation, Corporate Incubation in Entrepreneurial Ecosystem, Framework for Culture of Intrapreneurship.

MSL408 Startup Performance Management

3 Credits (3-0-0)

Management Processes for Startups, Defining & Setting Strategic Intent for Startups, Dynamic Timelines and Benchmarks, Measuring Financial and Non-financial Startup Performance, Qualitative and Quantitative Performance Metrics, Continuous Performance Feedback System.

Entrepreneurial Leadership, Leadership Issues in Entrepreneurial Setup. Functions as Entrepreneurial Leader, Transformational Enactment, Mental Models and Behaviour as Leader, Uncertainty Sense-making, Perceptual Barriers and Stereotypes, Integrative Actions, Motivation Building, Learning Ability of Founders, Acquire, Develop and Retain Entrepreneurial Talent, Environment for Entrepreneurial Transformation, Supporting key Stakeholders, Flexible Resource Deployment, Dynamic Capabilities for Startups, Leadership with Growth, Succession Management.

Strategic Management of Startups, Intent to Create Value, Process of Strategy Evolution, Balancing Emerging Stakeholder Expectations, Positioning for Potential Competition, New Venture Dynamic Capabilities, Strategic Implementation of Venture Business Model, Building New Capabilities from Success and Failure Cycle, Auditing Assets, Process, Capabilities and Competences, Dynamically Management of Key Information, Strategic Management and Control of Scarce Finance, Managing and Unifying Motivation, Sustainable Leadership Qualities for Entrepreneurs.

MSL409 Entrepreneurship and Life Balance

3 Credits (3-0-0)

Execution of Smart Life Plan, Internal Origins of Novel Ideas, Value Creation and Life View, Cost-benefit of an Entrepreneurial Aspiration, Aspiration Level on Time Scale, Family Ecosystem, Entrepreneurial Aspiration Acceptance by Family and Society, Appropriate and Effective Communication in Relationships, Art of Sharing Entrepreneurial Ideas with Family and Friends, Family Participation in Startup Decisions.

Work-life Balance for Entrepreneurs, Work-Life Symbiosis, Work-Life Balance as Contributor to Venture Success & Sustainability, Time Management, Setting Work Boundaries, Role of Determination, Aspiration and Time as a Resource, Scheduling & Prioritising Life, Wisdom Managing Personal Responsibilities, Planning and Flexibility Entrepreneurial time, Planning Open Time, Personal/Spiritual Development.

Staying Inspired. Continuous Learning, Initiating New Work Culture, Blending Formal and Informal Work Environments, Motivation and Fairness in Startup Environment, Aligning and Motivating Valued Employees for Personal Fulfilment. Anticipating & Planning for Entrepreneurial Risk, Preparing Startup Team for Exigencies, Managing Personal Impact from Startup Failures, Communicating Startup Failures, Extracting Learnings from Startup Failures, Life of Serial Entrepreneurs, Life of Successful Entrepreneurs, Life Quality Issues for Entrepreneurs.

MSL700 Fundamentals of Management of Technology

3 Credits (3-0-0)

Module I: Understanding technology: definition, Key concepts, role, importance, need. History of technological developments, Today's challenges. Issues of concern in Management of New Technology. Technology-Management integration, Life cycle approach to technology management. Technology innovation process. Managing and fostering the Innovation.

Module II: Technology forecasting and assessment. Technology flow and diffusion. Evaluating technology, technology planning and strategy, Strategic potential of new technology. Factors promoting technology acquisition. Flexibility in Technology Management. Technology transfer and absorption, Modes of global technology transfer. Technological Entrepreneurship.

Module III: Technology implementation. Integrating people and technology, human factors in technology operations. Organisation structure and technology. Investing for technological maintenance and growth. Concern of phasing out and upgradation. Market factors in technology operations, Science and Technology Policy, Technology support systems. Information networking for technological updatedness.

MSL701 Strategic Technology Management

3 Credits (3-0-0)

Module I: Emerging technology-strategy relationship in the large corporation from the perspective of individual firm, and entire industry. Global technology comparison, technological change, sources of technology, Technology Information. Criticality of technology for growth, core competencies, R&D productivity, Resource Leverage. World Class Organisation.

Module II: Corporate technology strategy, Generic competitive technology strategies. Corporate R&D, Strategic technology management process, relationship between technology strategy and corporate strategy. Strategic shifts and resource commitments, technology vision and goals, technology leadership. SWOT analysis for technology, Matching Business Portfolio and Technology Portfolio, Technology- Market matrix. Innovation and entry strategy, Flexibility in Technology strategy.

Module III: Business/technology alliances and networks. Technology forecasting and assessment. Technology strategy at business level. Strategic Technology Planning, Investment in Technology, Technology Strategy and functional strategy. Implementation and Control of technology strategy, Managing Corporate culture, structure, and interdepartmental linkages.

MSL702 Management of Innovation and R&D

3 Credits (3-0-0)

Module I: Technological innovation systems and processes. Understanding the process of technological innovation and the factors affecting successful innovation. Management problems from the product/service concept-stage to end-product/service marketing. Creativity and Innovation- Creativity process, Individual and group creativity, Critical functions in the innovation process, Evolving innovative culture, teams for innovation.

Module II: Product and technology life cycle, Management of R&D planning, organising, staffing, scheduling, Controlling, budgeting, Selection of R&D projects. Methodologies for evaluating the effectiveness of R&D, Research Productivity. Protection of Intellectual Property Rights. Evolving flexible organisation.

Module III: Issues relating to managing scientists and technologists as individual, in teams, and in large organisations. Human Resource Management in R&D and Innovation, training, motivation, communication, group dynamics. Information management for innovation and R&D- strategies, sources, channels, and flows. Standardisation and Quality management.

MSL703 Management of Technology Transfer and Absorption

3 Credits (3-0-0)

Module I: Transfer of technology from R&D to field and at international level. Commercialization of new technology and new

venture management, prototyping, test marketing, pilot plant, project viability, Technology push and market pull. Quality management, customer education and awareness. Assessment, justification and financing of new technology, source of funds, venture capital financing. New venture products and services.

Module II: Global transfer of technology, Technology transfer models: Active, passive. Multi channel approach: from hardware technical services acquisitions to strategic partnering and networking arrangements. Sourcing technology, technology negotiation, licensing agreement. Fee for technology transfer, royalty, equity participation. Modes: technological collaboration, joint venture, alliance, acquisition. International S&T cooperation: institutional framework, multilateral/bilateral cooperation, pre-emptive R&D cooperation.

Module III: Absorbent Strategy: Japanese technology absorption, Technology Absorption: product and process technologies, Reverse engineering. Appropriate technology. Vendor development. Adaptation and assimilation of technology.

MSL704 Science & Technology Policy Systems

3 Credits (3-0-0)

Module I: Role of S&T in economic development, Modern analysis of growth and structural change, international economic relations, liberalisation, globalisation/ regionalisation, industrial/technological partnerships, S&T in Indian Economic Policy. Government policy and its impacts on technology development. Living with the new technology, social issues. International trends, Technology policy in USA, Japan, European Commission, and other select countries.

Module II: National technology Policies, Regulatory Policies: Industries Development and Regulation Act, MRTP, FERA, Intellectual Property Rights, Patents act, Environment Protection Act, R&D Cess Rules, Import Export Policy; Development Policies: Industrial Policy Resolution, Scientific Policy Resolution, Technology Policy Statement, New Technology Policy, Policy on Foreign Investments and Technology Imports. Role of UN and other International Agencies.

Module III: Support Systems: Technology infrastructure, technology parks, Technology development and utilization schemes by government and Financial Institutions, Venture capital financing, TIFAC, Technology mission, Standards, Support to Small scale sectors. Research laboratories, and institutions. S&T in five year plans, Fiscal incentives. Organization set up for Science and Technology. R&D in corporate sector.

MSL705 HRM Systems

1.5 Credits (1.5-0-0)

This course focuses on various functions of human resource management. The course begins with the context and evolution of HR, followed by functions of HR via cases and various exercises. Manpower planning, job design, recruitment & selection, training & development, performance appraisal & management, compensation & reward management and career management, legal issues in HRM are the topics covered.

MSL706 Business Laws

3 Credits (3-0-0)

Module I: Nature of Business law, Source of Business law and their classification. Mercantile law, statute I Case law, Customs and Usage. Agreement and their legal obligations. Essential elements of a valid contract, types of contract, Void and voidable contract. Unenforceable and illegal agreements. Offer and acceptance over the telephone. Law of Arbitration –Definition of Arbitration, Effect of an arbitration. Arbitration without Intervention of Court. Powers and duties of Arbitrators.

Module II: Sale of Goods Act. Definition and essentials of a contract of sale, Distinction between sale and agreement to sell, sale and hire purchase, sale distinguished from contract for work and labour. Kinds of goods, perishable goods. Document to the title of goods. Rules regarding transfer of property, Transfer of Title on sale. Rules regarding delivery of goods. Buyers rights against seller, and unpaid seller's right. Consumer protection act. Consumers rights, consumer's disputes redressal agencies, consumer protection council.

Module III: Negotiable Instrumented act. Definition and characteristic of Negotiable instrument. Liabilities of Parties to

Negotiable Instruments. Brief exposure to Company law including incorporation of a company - objects, registration, article of association, raising capital from public, company management and reconstruction, amalgamation and winding up.

MSL707 Management Accounting

3 Credits (3-0-0)

On completion of this course the student will be able to: Understand accounting principles governing preparation of financial statements. Assess financial health of a corporate firm. Design profit planning. Understand cost control systems. Understand techniques of pricing, product and capital budgeting decisions.

MSL708 Financial Management

3 Credits (3-0-0)

The course is comprehensive and is designed to equip the students with tools and techniques to enable them to make sound financial decisions, among others, related to capital budgeting, working capital, capital structure and dividend policy.

MSL709 Business Research Methods

1.5 Credits (1.5-0-0)

Pre-requisite(s): MSL301 & MSL302

Introduction to Business Research Methods; Theoretical approaches; Problem definition; Research Design; Questionnaires & Scales; Sampling - Probability, size and challenges; Survey & Observation, Experiments; Qualitative Research, Secondary Data; Data Preparation & Analysis, Report Writing.

MSL710 Creative Problem Solving

3 Credits (3-0-0)

Module I: Structure of managerial problems. Open and close ended problems, convergent and divergent thinking. The creativity process, Individual and group creativity, Idea generation methods: Brain storming, Nominal Group Technique, Idea Engineering, Check list, Attribute listing, Morphological analysis, Synectics, Mental Imaging, Critical Questioning. Total System Intervention, Flexible Systems Methodology.

Module II: Idea Structuring: Graphic tools, Programme Planning Linkages, Interpretive Structural Modelling, Relationship Analysis, Flexible Systems Management, SAP-LAP Analysis, Flexibility Influence Diagrams, Collaboration Diagrams. Scenario Building: Harva method, Structural Analysis, Options Field/Profile Methodology.

Module III: Viable Systems Modelling. Fuzzy sets in multicriteria decision making, Analytic Hierarchy Process, Intelligent Management Systems, Creativity applications in TQM and Business Process Reengineering.

MSL711 Strategic Management

3 Credits (3-0-0)

Understanding new perspectives on strategic management, Content and process of strategic management, Formulation and implementation of strategies, Developing cross-functional trade-off decision making skills, and Help appreciate new themes in strategic management. This course will require reading books, articles, case studies and literature from the field of Strategic Management. The sessions would be interactive where attempt will be made to understand the theories and concepts through discussion of the readings and their application in cases. Student will be required to prepare and effectively participate in class and make impromptu or scheduled presentations of issues and learnings. Besides the readings, groups of students will have to work on a comprehensive research project to investigate and validate some of the key learnings.

MSL712 Ethics & Values Based Leadership

1.5 Credits (1.5-0-0)

Pre-requisite(s): MSL301 & MSL302

Ethics & Business, Ethical principles in business, Business and Its External Exchanges: Ecology & Consumers, Business & Its Internal Constituencies.

MSL713 Information Systems Management

3 Credits (3-0-0)

Pre-requisite(s): MSL301 & MSL302

This course may expose the participants to the following topics: Information Systems and its impact in Organization and People, Information Technologies: concepts, types and usage, Information Systems, Organizations and Strategy, Economics of Information Systems, Foundations of E-Business, Foundations of Data management, Foundations of Business Analytics, Networks and Collaboration as Business Solutions, Information Security & Risk Management, Building and Managing Systems, Enterprise Systems, etc. Hands on training would also be provided, using specific tools.

MSL714 Organizational Dynamics and Environment

3 Credits (3-0-0)

Pre-requisite(s): MSL301 & MSL302

Module I : Organisational systems vix. a vis., the environment. The dialectics of agency and structure- extent of environmental and organizational control. External control of organization. Organizations and the new institutionalism. Systems for managing chaos and conflict.

Module II : Constituent systems for organizational functioning- planning, learning, organising, communication and control systems. Organizational systems and mechanisms related to technology. Systems for managing strategy, and structure related to new technology.

Module III : Systems for managing continuous and radical change for organizational renewal and transformation. Adaptiveness and flexibility in organisational systems. Systems for managing collective action within the organization. Feminism and organizational systems for managing gender diversity.

MSL715 Quality and Environment Management Systems

3 Credits (3-0-0)

Pre-requisite(s): MSL301 & MSL302

Module I : Concept of Total Quality, Quality Management Systems as a means of achieving total quality. Linkage of Quality and Environment Management System. Strategic concern for Environment. Need and relevance of documentation and standardization of Management Systems. Various tools of documenting and recording the Management Systems, Various standards for Management Systems. Flexibility and change in Management Systems and documented procedures.

Module II : Quality Management Systems, ISO 9000, Quality Policy, Data, Records and Traceability. Documenting the Quality System: Quality Manual, Quality Audit, Design and Change Control, ISO 9000 Registration. Six Sigma. Awards and appreciation, DMAIC approach.

Module III : Need for proper Environment Management Systems and their economic implications. Environment Management Systems, Green Products and Strategies, Environment Assessment: Environment Protection Act, ISO 14000, Case Studies.

MSL716 Fundamentals of Management Systems

3 Credits (3-0-0)

Module I : Basics and Variants. The concept of a system, Systems Approach to management. Emerging paradigm, customer centred management systems, Flexible Management Systems. Management of Paradoxes. Management Systems in various countries: Western Management Systems, Japanese Management Systems, Chinese Management System, Indian Management Systems. Organisational Culture and Value System.

Module II : Management Systems in Operation: Strategic Planning Systems, Management Control Systems, Financial Information Systems, Marketing Management Systems, Logistics and Distribution Systems, Systems for Human Resources Planning and Performance Management. System Dynamics Modelling.

Module III : Methodologies for Development and Improvement. Methodology for developing Management System. Optimization and Learning Systems methodologies, Microworld, Continuous Improvement and Reengineering of Management Systems. Organizing to improve systems.

MSL717 Business Systems Analysis & Design

3 Credits (3-0-0)

Pre-requisite(s): MSL301 & MSL302

This course will have the following topics: System Analysis Fundamentals: Introducing SA&D for Systems Professionals, Analyzing the Business Case and Managing Systems Projects, Overview to Data Structure in Systems Modeling, Data Flow Diagrams and Modelling DFDs, Requirements Modelling and Systems Specification, User Driven Business Analysis, Role of the consultant, Object Oriented Modelling: Object Relationships, Hierarchies, Use Case Approaches to identify and model classes, Process Driven Approaches: Gane, Sarson and Yourdon techniques, Data Driven Approaches: Entity Relationship Diagrams, Designing the User Interface and Output, Verification & Validation of new systems.

MSL718 Management of Blockchain Technology

1.5 credit (1.5-0-0)

Fundamental building blocks of blockchain. Concepts of distributed databases, blocks, encryption, and overall scope of blockchain, Understanding implications and applications of blockchain characteristics like decentralization, immutability, transparency, disintermediation, sharability, privacy, security, authentication, traceability, auditability, data integrity and efficiency, Applications in agriculture; banking; management; finance, capital markets, services; governments; high-tech enterprises; etc

MSL719 Statistics for Management

3 Credits (3-0-0)

Pre-requisite(s): MSL301 & MSL302

Nature and role of statistics for management. Types of data, data measurement scales, Descriptive Statistics: Measures of Central Tendency, Measures of Dispersion. Introduction to probability theory. Probability Theory: Preliminary concepts in Probability, Basic Theorems and rules for dependent/independent events, Random Variable, Probability distributions. Sampling Techniques, Sampling distributions. Hypothesis testing: Z-test, t-test, ANOVA, Chi-square tests, Correlation and regression analysis. Business Forecasting. SPSS and its use for statistical modeling.

MSL720 Macroeconomic Environment of Business

3 Credits (3-0-0)

Pre-requisite(s): MSL301 & MSL302

Introduction to macroeconomic environment of business, Macroeconomic policies and Business Cycles, Economic Growth vs. Economic Development, Measurement of macroeconomic performance, Classical Macroeconomic Theory, Keynesian Model Income determination, Great Depression of 1930s; South East Asian Crisis of 90s, Sub-prime Crisis of 2007 and Euro crisis and Fiscal Sustainability; and their impact on the Business. Economic Reforms in India, Growth pattern of Indian economy, Fiscal Policy and its managerial implications to the industry, Government Budget, Monetary policy analysis and its implications to industry. Industrial Policy of India, Competition Policy of India, Balance of Payments, WTO and India.

MSL721 Econometrics

3 Credits (3-0-0)

Pre-requisite(s): MSL301 & MSL302

Introduction to Econometrics, Simple linear regression model. Multiple linear regression model, Discrete Choice, Panel Data, Time Series, Stationarity, VAR, Co-integration and Error correction models.

MSL722 Managing Enterprise AI/ML Systems

1.5 credit (1.5-0-0)

Overview to models for Enterprise AI/ML applications and objectives; Different types of intelligent algorithms; managing supervised, semi supervised and unsupervised algorithms; Building enterprise data models for AI/ML applications; Emergence of new intelligent models and their outcome

Managing Neural Networks based applications, Managing Bio Inspired and swarm based applications; Managing tradeoffs between computational and data challenges; Managing large scale applications like AI Chat-bots, recommender systems, social CRM systems management and policy interventions, Managing adverse outcome in AI/ML applications; mitigation of risk for adverse outcome; Interventions for policy making and governance; Addressing transparency, fairness, explainability and accountability in enterprise applications.

MSL723 Telecommunications Systems Management

3 Credits (3-0-0)

Module I : Telecom Technology Systems Evolution: Recent Developments in Telecom Industry, Regulation & Liberalization policy. Techno-managerial aspects of telecommunication, role of the telecommunication managers in a dynamic environment. The business of telecommunication; telecommunication as a facilitating infrastructure for economic development of the country, technical survey of the ways and means that voice, data and video traffic are moved long distances, data network, the telephone system.

Module II : Issues of the monopolization and deregulation of telecom, national telecom policy, various institutions/organizations like telecom regulatory authority etc; conveyance. Telecom service costing, economic evaluation of telecom projects, telecom project financing.

Module III : Telecom marketing, building brand equity for competitive advantage, Customer care, total service quality management, preparing for the new millennium managing change and people development.

MSL724 Business Communication

1.5 Credits (1.5-0-0)

Pre-requisite(s): MSL301 & MSL302

On completion of this course, students would be able to: Evaluate the key purposes of communication in business. Explain the communication process model and the barriers to effective communication. Understand & evaluate the changing landscape of business communication. Apply techniques for effective communication.

MSL725 Business Negotiations

1.5 Credits (1.5-0-0)

Pre-requisite(s): MSL301 & MSL302

Students who complete this course would be able to: (a) Understand the nature, process and structure of negotiations. (b) Understand different types of negotiations and the dynamics of cooperative and competitive interaction in negotiations. (d) Appreciate and leverage their bargaining position in a situation. (e) Learn and apply influence and persuasion techniques. (f) Learn ways to build lasting working relationships. (g) Understand and appreciate ethical negotiations.

MSL726 Telecom Systems Analysis, Planning and Design

3 Credits (3-0-0)

Pre-requisite(s): MSL301 & MSL302

Module I : An introduction to the basic system analysis tools, the procedures for conducting system analysis advanced software principles, techniques and processes for designing and implementing complex telecommunication systems.

Module II : Planning and implementation of telecommunications systems from strategic planning through requirements, the initial analysis, the general feasibility study, structured analysis, detailed analysis, logical design, and implementation.

Module III : Current system documentation through use of classical and structural tools and techniques for describing flows, data flows, data structures, file designs, input and output designs, and program specifications. The student would gain practical experience through a project as part of a term paper.

MSL727 Interpersonal Behavior & Team Dynamics

1.5 Credits (1.5-0-0)

Pre-requisite(s): MSL301 & MSL302

On completion of this course, students would be able to: Understand

the nature, structure and formation of teams. Appreciate the competitive and collaborative dynamics between teams and sub-teams. Understand and apply techniques for building and sustaining high performing teams. Reflect on their roles within teams and its impact on other members.

MSL728 International Telecommunication Management

3 Credits (3-0-0)

Module I : Historical development and evolution of telecom, managerial issues and structure of industry; evolution and role of international institutions; global trends in liberalization and de-regulations, Patterns of Transaction in international telecom management; managing the market growth; developing, operating and monitoring regulation issues.

Module II : Role of telecommunications in socio-economic development; ICT & Social change, new technologies and services for international telecommunications; data services and business applications, Telecom prospectus of WTO & other international bodies.

Module III : Current issues and organisational growth; telecom implications for the industry, value added services and market drives; regional perspectives on development of telecom; Human Resources Planning and Industrial relations in ITSM; skill formation for ITSM and learning renewal, future directions of growth.

MSL729 Individual Behavior in Organization

1.5 Credits (1.5-0-0)

Pre-requisite(s): MSL301 & MSL302

This course will focus on understanding the nature, composition and relevance of organizational behaviour. Students will be introduced to the fundamental concepts and theories underpinning organizational behaviour. For every concept/theory introduced, its application for organizations would be discussed.

MSL730 Managing With Power

1.5 Credits (1.5-0-0)

Pre-requisite(s): MSL301 & MSL302

This course covers power dynamics, the basic art of influencing, types of power, display of power at various levels and power vs empowerment and ethics. Various cases and readings are included for deeper understanding and application of the learnings.

MSL731 Developing Self Awareness

1.5 Credits (1.5-0-0)

Pre-requisite(s): MSL301 & MSL302

Important areas of self awareness: Personal values, moral maturity, cognitive styles, attitude towards change, Locus of control, social needs of achievement, inclusion, control and affiliation.

MSL733 Organization Theory

1.5 Credits (1.5-0-0)

Pre-requisite(s): MSL301 & MSL302

Different issues related to the organization would be discussed and then applied in real life situations, the emphasis will be on application of theory to real life situations. The course would be imparted through a combination of lectures, cases and simulation exercises.

MSL734 Management of Small & Medium Scale Industrial Enterprises

3 Credits (3-0-0)

Pre-requisite(s): MSL301 & MSL302

Module I : MSME Act 2006; Nature of entrepreneurial management, the new entrepreneur, his problems and prospects in the Indian environment. Practical aspects of setting up and running of industrial enterprises including formulation of projects and feasibility study for new projects.

Module II : Raising resources for new enterprises. Location, design, product and process. Choice of technique in small & medium businesses. Survey needs for growth of the enterprise. Monitoring to avoid sickness. Development and diversification.

Module III : Integration with LSEs and MNCs. Informations network for new enterprises. Implication of WTO to SMEs. Globalisation & Competitiveness of SMEs. Entrepreneurship in the globalisation era.

MSL735 Qualitative Methods in Management Research

3 Credits (3-0-0)

Qualitative research methods in management research - Philosophical assumptions; Biography; Phenomenological study; Grounded Theory Method; Ethnography; Case Study; Content Analysis; NVivo/Atlas Ti; Narrative Analysis; Template analysis; Writing.

MSL740 Quantitative Methods in Management

3 Credits (3-0-0)

Pre-requisite(s): MSL301 & MSL302

Module I : Role of quantitative methods and operations research for managerial decision making and support. Role of mathematical models in problem formulation and solving. Structure of decisions, statistical decision theory; decision making under uncertainty, risk, certainty. Decision Trees; Fuzzy Decision Making. Game theoretic applications. Mathematical Programming models- formulation and applications. Linear Programming- graphical method, Simplex technique; transportation, assignment and transshipment problems. Mixed Integer Programming.

Module II : Non-Linear Programming, introduction to Quadratic Programming, Geometric Programming and Direct Search techniques. Multiple Criteria Decision making- Goal programming, TOPSIS and AHP.

Module III : Sequential decisions using Dynamic Programming. PERT and CPM. Queuing theory- M/M/1 and M/M/n model. Monte Carlo System Simulation concepts and applications. Brief introduction to Non-traditional optimization. Case Study applications and use of OR software packages.

MSL745 Operations Management

3 Credits (3-0-0)

Module I : Managing operations; planning and design of production and operations systems. Service characteristics. Facilities planning- location, layout and movement of materials. Line balancing. Analytical tools and techniques for facilities planning and design.

Module II : Production forecasting. Aggregate planning and operations scheduling, Production Planning and Control. Purchasing, Materials Management and Inventory control and JIT Material Requirements Planning. MRPII, ERP, Optimization techniques applications.

Module III : Work Study, Value Engineering, Total quality & statistical process control. Maintenance management and equipment policies. Network planning and control. Line of Balance, World class manufacturing and factories of the future, Case studies.

MSL750 Behavioral Finance

1.5 credit (1.5-0-0)

This course aims to develop a holistic understanding of behavioral finance. We start with tracing the evolution of behavioral finance and learn how it differs from classical rational finance. We then discuss some of the common biases in humans. We connect all of these to study the concept of prospect theory. We also introduce some market anomalies and their possible explanations using behavioral finance. To conclude, we develop framework on how we can mitigate these biases as investor and in firms.

MSL751 Financial Technology

1.5 credit (1.5-0-0)

This course aims to develop a holistic understanding of FinTech –evolution, interaction with finance, and major technologies driving FinTech. We discuss about money and payment, including digital money and cryptocurrencies, and some introduction to the underlying Blockchain and cryptography technologies. Applications in Investments and trading under the Fintech environment are discussed along with introduction to data protection and privacy,

cybersecurity and technological risk. Multiple case studies provide a practical overview into the FinTech development in developed and emerging markets. We also discuss the evolving nature of regulation that comes with Fintech, including Regtech and wrap up with ideas on how technology could continue to transform the careers and finance in the future.

MSL760 Marketing Management

3 Credits (3-0-0)

Module I : Introduction to Marketing function; genesis, the marketing concept. Marketing Management System: objectives, its interfaces with other functions in the organisation. Environment of Marketing- Political Environment Economic Environment, Market segmentation Consumer buying behaviour. Socio- cultural environment. Legal Environment. Ethical issues in marketing.

Module II : Marketing Strategy- Marketing planning and Marketing programming. The concept of marketing mix, Product policy; the concept of product life cycle. New product decisions. Test marketing- Pricing, Management of distribution: channels of distribution. Advertising and promotions. The concept of Unique Selling Proposition.

Module III : Implementation and Control. The marketing organization- alternative organization structures; the concept of product management. Administration of the marketing programme: sales forecasting; marketing and sales budgeting; sales management; management of sales force. Evaluation of marketing performance; sales analysis; control of marketing effort; marketing audit.

MSL780 Managerial Economics

1.5 Credits (1.5-0-0)

Pre-requisite(s): MSL301 & MSL302

Introduction to managerial economics. Basic concepts, Consumer behavior, Demand analysis: Determinants, estimation and managerial uses of elasticity of demand. Demand forecasting. Supply function and Market equilibrium analysis. Production and Cost analysis and Equilibrium of the firm, production Analysis, Productivity Analysis, Production efficiency analysis. Pricing and output under different market situations: Perfect Competition, Monopolistic Competition, Monopoly, Oligopoly and Cartels.

MSL781 Macroeconomic Dynamics

3 Credits (3-0-0)

Dynamic Optimization Methods: Deterministic Models, Dynamic Programming under Certainty with Applications, Deterministic Dynamics, Stochastic Models, Markov Processes, Stochastic Dynamic Programming with Applications, Competitive Equilibrium with Applications; Simple Aggregate Models: Dynamics in AD-AS Model, Dynamic Models of Output and Inflation, Introduction to Expectations: Adaptive vs. Rational Expectations, Micro-Foundations in Modern Macroeconomics; Open Economy Extensions: Introduction to Dynamics of Small Open Economies, Exchange Rate Dynamics; Optimal Growth Models: the Solow Growth Model, Neo-classical Growth Model, Growth with Overlapping Generations, Endogenous technological Change, Stochastic Growth Models; Introduction to DSGE Models: Stylized facts on Business Cycles, Calibration, Hodrick-Prescott Filter, Limitations and Critiques.

MSL782 Business Cycles and Global Economy

1.5 credit (1.5-0-0)

Economy moves in cycles. Depending on the state of economy (in whether expansion or downturn), the firms should adjust their business and investment strategies. This course will look into the state of art of business cycles under the increasingly integrated global economic system, and discuss the usefulness and application of the cyclical analyses for the appropriate and flexible decision making. Global business cycles; short and long cycles; fluctuation; synchronization; identification, driver and nature of cyclical movements; endogenous and exogenous views; political economy; role of manufacturing; transmission mechanism; trend analysis; structural shift in the global system; China; India; forecasting and indicators; COVID-19.

MSL783 Global Economic Development*1.5 Credit (1.5-0-0)*

The course will discuss the shift in the global economic power, necessary and enabling conditions for the strong economic growth and national development under the globalized world, and its implication for the business. Economic development; capitalism; world economy; theory and empirical evidences; structural shift; industrial revolution; modernization; rise and decline of the West and Japan; China as emerging power; economic structure; elasticity; colonialism; Bretton Woods institutions; globalization; currency war; trade war; secular stagnation; long cycles; economic and financial crises; uneven sectorial development; business opportunity.

MSL784 Sovereign Debt and Default*3 Credits (3-0-0)**Pre-requisite(s): MSL720*

Origin of money, banks, and the central banking; Sovereign debt; The role of borrowing; External and foreign currency borrowing; Sovereign default: A historical perspective; Theoretical models of default (e.g., reputation); Laws and economics of sovereign default and restructuring; Sovereign debt and default- The International Experience.

MSL799 Theories in IS Research*1.5 Credit (1.5-0-0)*

This is a research based course which will expose the Ph.D. scholars to the advanced methods and theoretical models in information systems management. Participants would be expected to understand a lot of emergent theories and research methods in the information systems domain. Pedagogy would be seminar and discussion based on exhaustive set of readings compiled on high impact research papers.

MDL800 Management of Blockchain Technologies*1.5 Credits (1.5-0-0)**Pre-requisite(s): MSL713*

(about 100 words; Topics to appear as course contents in the courses of Study booklet) (Include Practical / Practice activities): Fundamental building blocks of blockchain. Concepts of initiating a blockchain project and management challenges surrounding complexity assessment, feasibility assessment, deployment, maintenance and technology upgradation. Understanding managerial implications of blockchain characteristics on adoption and diffusion in firms. Does the elements tie with Roger's diffusion of innovation for emerging technologies? How do these characteristics require specific interventions in terms of organizational structures and relationships among participating organizations? Understanding governance and information management of blockchain characteristics, how can organization structure and networks play a role, understanding antecedents of diffusion of blockchain applications among firms and networks in industries, understanding enablers and barriers to use and usefulness of blockchain. Management case studies in corporate: banking; digital services; high-tech enterprises; supply chain. Management case studies in government and society, stakeholder specific impacts assessment.

MDD801 MBA Project*3 Credits (0-0-6)*

The topic for the major project would be a generic one, pertaining to a management problem/issue related to any functional area viz. finance, operations, strategy, HR, marketing, IT, econometrics etc. Latest management & research tools and techniques would be applied in the analysis. The project would also be evaluated by an external expert. Each MBA project would be unique and the contents would be decided on the advice of the project supervisor.

MSL801 Technology Forecasting & Assessment*3 Credits (3-0-0)*

Module I : Forecasting as an input to technology planning, Futures Research, Elements of forecasting process. Types of forecasting

methods. Quantitative methods of forecasting: time series models, growth curves, Precursor, Envelope curves, Experience curves, technical assessment.

Module II : Qualitative methods: Morphological analysis, Relevance trees, Delphi, Technological gap analysis, Analogy method, Organising for Technology Forecasting.

Module III : Technology assessment: Components, problem definition, Social description, Measure, Impact assessment. Strategies for assessment, Economic impact analysis. Assessment of risk and uncertainty. Safety and environment considerations.

MSP801 Interdisciplinary Research in Management*1 Credit (0-0-2)*

Fundamentals of zinter/multi-disciplinary research, identify and understand complex problems, defining complex problems, designing inter-disciplinary research, conducting research in teams, preparing a working draft of the paper.

MSV801 Selected Topics in OB & HR Management*1 Credit (1-0-0)*

The course will cover selected topics in emerging areas of research and practice in the area of OB & HR Management. The topics covered will vary with each offering of the course, and will be defined by the faculty member teaching the course.

MDD802 MBA Project*3 Credits (0-0-6)*

The topic for the major project would be a generic one, pertaining to a management problem/issue related to any functional area viz. finance, operations, strategy, HR, marketing, IT, econometrics etc. Latest management & research tools and techniques would be applied in the analysis. The project would also be evaluated by an external expert. Each MBA project would be unique and the contents would be decided on the advice of the project supervisor. The project would need to focus on telecom sector.

MSL802 Management of Intellectual Property Rights*3 Credits (3-0-0)**Pre-requisite(s): MSL301 & MSL302*

Module I : Nature of Intellectual Property; Patents, Industrial Design, Trademark and Copyright; Process of patenting and development; technological research, innovation, patenting, development; International cooperation on Intellectual Property; International treaties on IPRs; Patenting under PCT. Procedure for grants of patents.

Module II : Scope of Patent Rights; Licensing and transfer of technology; Patent information and databases; Geographical Indications.

Module III : Administration of Patent System. New developments in IPR; IPR of biological systems, plant varieties, computer softwares etc. Traditional knowledge; Case Studies; IPR and IITs.

MSV802 Selected Topics in Finance*1 Credit (1-0-0)*

The course will cover selected topics in emerging areas of research and practice in the area of Finance. The topics covered will vary with each offering of the course, and will be defined by the faculty member teaching the course.

MDD803 MBA Project*3 Credits (0-0-6)*

The topic for the major project would be a generic one, pertaining to a management problem/issue related to any functional area viz. finance, operations, strategy, HR, marketing, IT, econometrics etc. Latest management & research tools and techniques would be applied in the analysis. The project would also be evaluated by an external expert. Each MBA project would be unique and the contents would be decided on the advice of the project supervisor. The project would need to focus on technology sector.

MSL803 Technical Entrepreneurship*3 Credits (3-0-0)*

Module I : Basis and challenges of entrepreneurship Technological entrepreneurship, Innovation and entrepreneurship in technology based organisations, High tech. entrepreneurship. Entrepreneurial characteristics. Concept of new ventures. Technology absorption, Appropriate technology. Networking with industries and institutions.

Module II : Starting a new technological venture and developing the business: Business idea, Business plan, Marketing plan, Financial plan, Organisational plan. Financing a new Venture: Sources of Capital, Venture Capital, Going public. Entrepreneurship & liberalization.

Module III : Managing the new technological venture: Developing systems in new venture, Managing doing early operations, Growth and expansion, ending the venture. Legal issues, Franchising and acquisition. Entrepreneurship, globalisation and Entrepreneurship.

MSV803 Selected Topics in Information Technology Management*1 Credit (1-0-0)*

The course will cover selected topics in emerging areas of research and practice in the area of Information Technology Management. The topics covered will vary with each offering of the course, and will be defined by the faculty member teaching the course.

MSL804 Procurement Management*3 Credits (3-0-0)**Pre-requisite(s): MSL301 & MSL302*

This course will introduce students to purchasing and materials management by learning the planning production process, master scheduling, material requirements, and forecasting material demands and inventory levels. This course is designed to build on the student's knowledge of how effective material management improves supply chain performance.

MSV804 Selected Topics in Operations Management*1 Credit (1-0-0)*

The course will cover selected topics in emerging areas of research and practice in the area of Operations Management. The topics covered will vary with each offering of the course, and will be defined by the faculty member teaching the course.

MSL805 Services Operations Management*3 Credits (3-0-0)**Pre-requisite(s): MSL301 & MSL302*

This case course explores the dimensions of successful service firms. It prepares students for enlightened management and suggests creative entrepreneurial opportunities. The main idea behind the course is:

To study "breakthrough" services in order to understand the operations of successful service firms that can be benchmarks for future management practice.

To develop an understanding of the "state of the art" of service management thinking.

To understand the dimensions of service growth both domestically and internationally.

MSV805 Selected Topics in Economics*1 Credit (1-0-0)*

The course will cover selected topics in emerging areas of research and practice in the area of Economics. The topics covered will vary with each offering of the course, and will be defined by the faculty member teaching the course.

MSL806 Mergers & Acquisitions*3 Credits (3-0-0)*

(i) Valuation & Financial framework of M&A. (ii) The strategic perspective of M&A. (iii) The managerial perspective of M&A.

MSV806 Selected Topics in Marketing Management*1 Credit (1-0-0)*

The course will cover selected topics in emerging areas of research and practice in the area of Marketing Management. The topics covered will vary with each offering of the course, and will be defined by the faculty member teaching the course.

MSL807 Selected Topics in Strategic Management*1 Credit (1-0-0)*

Open slot course (To be decided when the course is floated). The course will cover selected topics in emerging areas of research and practice in the area of Strategic Management. The topics covered will vary with each offering of the course, and will be defined by the faculty member teaching the course.

MSL808 Systems Thinking*3 Credits (3-0-0)*

Module I: Systems thinking in management; Hard and soft systems thinking; open systems thinking; Analytical and systems approaches; System concepts, principles and metaphors; General systems theory and cybernetics.

Module II: Theory building with causal loop diagrams; Feedback loop structures; Linking feedback, stock and flow structures; Tutorial on Stella; Case Studies on system dynamics modelling.

Module III: Soft systems methodology; Flexible systems thinking; Management of continuity and change; Interpretive systems model.

MSL809 Cyber Security: Managing Risks*3 Credits (3-0-0)**Pre-requisite(s): MSL301 & MSL302*

This course introduces students to the interdisciplinary field of cybersecurity by discussing the following: cybersecurity theory, and the relationship of cybersecurity to nations, businesses, society, and people, cybersecurity technologies, processes, and procedures, analyzing threats, vulnerabilities and risks present in these environments, and develop appropriate strategies to mitigate potential cybersecurity problems, advanced policy related topics would also be covered through which these risks may be mitigated. Other relevant advanced topics may be explored.

MSL810 Advanced Data Mining for Business Decisions*1.5 Credits (1.5-0-0)**Pre-requisite(s): MSL301 & MSL302*

This course will expose the participants to the following topics within this domain: Understanding advanced models of data mining, advanced unsupervised mining methods and approaches, Decision Support Systems, Group Decision Support Systems, Consensus based systems, Multi-criteria decision systems, Knowledge management systems, knowledge management methods, Intelligent systems, Hybrid data mining methods, Advanced and emergent topics and applications.

MSL811 Management Control Systems*3 Credits (3-0-0)**Pre-requisite(s): MSL301 & MSL302*

Module I : Nature of Management Control Systems: planning and control process. Essentials of Management Control System. Behavioural aspects of Management Control-motivation and morale, goal congruency, and so on. Management Control Process: Programming, Budgetary Planning and Procedures, Fixed and Flexible Budgeting, Zero Base Budgeting. Internal Audit and Internal Control. Standard Cost Accounting Systems as measures of operating performance.

Module II : Variance Analysis and reporting of financial performance: Material, Labour and Overhead Cost Variances, Revenue Variances, Profit Variances, Variance Reporting.

Module III : Management Control Structure: Responsibility

Accounting System- Concept of Responsibility Centre, Expense Centre, Profit Centre, Investment Centre. Inter-Divisional Transfer Pricing System, Measurement of Division Performance.

MSL812 Flexible Systems Management

3 Credits (3-0-0)

Module I : Emerging management paradigms: Total Quality Management, Business Process Reengineering, Learning Organisation, World Class Organisation, Flexibility in Management. Concept of systemic flexibility. Liberalisation, Globalisation and change. New Organisation forms.

Module II : Concept and dimensions of Systemic flexibility. Managing paradoxes. Methodology and tools of flexible systems management. Underlying values, and guiding principles, Case Analysis using SAP-LAP framework. SAP-LAP models and linkages.

Module III : Flexibility in functional systems, Information Systems flexibility, manufacturing flexibility, organisational flexibility, financial flexibility, and strategic flexibility. Linkage of flexibility with organisational performance.

MSL813 Systems Methodology for Management

3 Credits (3-0-0)

Module I : Introduction to systems methodology, Flexible Systems Methodology, Need and applicability of Systems methodology for management. Nature of managerial problems. System Dynamics Methodology- Philosophy, Foundation, Steps, building blocks, feedback structures, principles of systems, learning organisation.

Module II : Validation, Simulation and testing of System Dynamics models, Policy analysis, Micro world and Management games, Managerial applications of Systems methodology.

Module III : Management of physical systems. Physical system theory: fundamental premises and postulates, modelling of basic processes, application to manufacturing, managerial, and socio-economic systems. Critical comparison and integration of Physical System Theory and System Dynamics. Flexibility in physical system theory.

MSL814 Data Visualization

1.5 Credits (1.5-0-0)

Pre-requisite(s): MSL301 & MSL302

This course would have the following: It would train the participants to use visual imagery to present complex information and the trends associated with extensive data. Visualization provides a solution to address information overload, through a well-designed visual encoding to aid comprehension, memory, and decision making. Furthermore, visual representations may help engage more diverse audiences in the process of analytic thinking. Topics like data and image models, heat maps, infographics, multidimensional data visualization and representation, graphical perceptions, mapping & cartography and text visualization may be covered. Other relevant topics within the subject domain may also be explored.

MSL815 Decision Support and Expert Systems

3 Credits (3-0-0)

Pre-requisite(s): MSL301 & MSL302

Module I : The management support framework for computers. Fundamentals of decision theory and decision modelling. Humans and information processors and information systems as decision systems. Human decision styles.

Module II : Models, heuristics, and simulation. Overview of DSS-database, modelbase, user interface. DSS development methodology and tools. Need for expertise in decision models and expert systems. Expert systems fundamentals. Knowledge engineering, knowledge representation and inferencing. Building expert systems.

Module III : Integrating expert systems and DSSs. Strategies for implementing and maintaining management support systems. Case studies, and laboratory and filed projects.

MSV815 Case Study Writing and Teaching

1 Credit (1-0-0)

Various concepts of case study teaching and writing will be covered.

MSL816 Total Quality Management

3 Credits (3-0-0)

Pre-requisite(s): MSL301 & MSL302

Module I : Introduction to TQM; Customer Orientation, Continuous Improvement, Quality, Productivity and Flexibility, Approaches and philosophies of TQM, Quality Awards, Strategic Quality Management, TQM and corporate culture, Total Quality Control; Basic Analytical tools-Check Sheets; Histograms; Pareto charts, Cause and Effect diagrams; Flow charts.

Module II : Statistical Process Control; Advanced Analytical tools-Statistical Design of Experiments; Taguchi Approach; Cost of Quality; Reliability and failure analysis. FMECA, Quality Function Deployment, Benchmarking, Concurrent Engineering.

Module III : Quality Teams, Employee practices in TQM organisations: Leadership, delegation; empowerment and motivation; role of communication in Total Quality, Quality Circles; Total Employee Involvement; Problem Solving in TQM- Brain storming; Nominal Group Technique Team process; Kaizen and Innovation; Measurement and audit for TQM; Quality Information Systems, ISO 9000 series of Quality Standards; TQM Implementation; Reengineering and TQM.

MSV816 Contemporary Issue in Management

1 credit (1-0-0)

The content of the course around a selected advance topic in Management

MSL817 Systems Waste & Sustainability

3 Credits (3-0-0)

Module I : Introduction to waste and waste management. The concept of wastivity and its inter-relationship with Productivity Quality and Flexibility. Systems concept of waste, complementarity of waste and resource management. Functional elements of waste management. Waste management and cost reduction. Taxonomy of wastes, JIT, TQM and waste.

Module II : Management of waste in industrial and service sectors. Management of manpower waste and unemployment. Management of energy waste in the national economy. Energy recycling, Waste management and energy conservation. Total energy concept, overall energy wastivity.

Module III : Interfaces of waste management: environment control, nature conservation, resource development, Quality and Productivity Management, Business Process Reengineering. Role of legislation and government. Waste management and national planning.

MSV817 Art of Scholarship in Management Research

1 Credit (1-0-0)

Understanding the role of a scholar in society, Knowing various aspects of 'Body of Knowledge', Understanding the purpose and structure of Academic Bodies in the management discipline, Various forms of scholarly outlets (symposium, workshop, seminar, conclave, conference, summit, meet, reviews, communications, journals, open etc.), Prevalent Style and methods of scholastic writing, Assessing value of scholarly publications (prevailing Indices & Impact factors), Pre and Post internet scenarios, Interaction with an established scholar.

MSL818 Industrial Waste Management

3 Credits (3-0-0)

Pre-requisite(s): MSL301 & MSL302

Module I : The concept of industrial system. Systems waste and waste management. Wastivity and productivity measurement. The categories of industrial systems waste. Stages and causes of waste generation in industrial systems. Waste reduction measures and systems in industry. Collection and disposal system of scrap, surplus and obsolete items. Recycling and processing of industrial waste. Industrial pollution and environment control.

Module II : Value engineering, design waste and cost reduction. Inspection rejects and quality management. Reliability, maintenance, breakdown and management of waste. Space waste and layout

planning. Time management, manpower waste in industry, absenteeism. Capacity utilization. Waste heat recovery and energy waste in industry. Resource conversation/loss prevention in process industries. Data and information waste, management of hazardous waste. Waste treatment. Natural calamities. Accident prevention, industrial safety and waste management.

Module III : Waste management in Indian industries- present practices, potentials and perspectives. Management of waste in different industrial systems- steel, aluminum, power, automobile, transport and other service industries. Economic analysis and system models of industrial waste management systems. Analytical and Creative techniques to waste control.

MSV818 Contemporary Issues in OB & HR Management

1 Credit (1-0-0)

The contents of the course around selected contemporary topic(s) in HR and OB.

MSL819 Business Process Re-engineering

3 Credits (3-0-0)

Module I: Nature, significance and rationale of Business Process Reengineering, Reengineering scenarios in major countries, Problems issues, scope and trends in BPR, Implementing BPR: Methodology and steps, IT enabled reengineering, mediation and collaboration.

Module II: The paradigm of Mass customization, managing organisational change, Transforming/ Reinventing the enterprise, Team building. Case studies of success as well as failure.

Module III: People view, empowering people, reengineering management. Issues of purpose, culture, process and performance, and people.

MSV819 Contemporary Issues in Finance

1 Credit (1-0-0)

The contents of the course would be built around the particular nuance and/or emerging perspective.

MSL820 Global Business Environment

3 Credits (3-0-0)

Module I : Global Scene. Historical and economic background, firms and International Business. The global scene and the challenges ahead, challenges to free International Trade Political Risk, Protection, Accounting, Taxation and Legal practices. The International debt risks.

Module II : Regional Issues. Global Monetary Institutions and Trade Agreements, Regional Trade Agreements and Facts. Socio-cultural context of International Business: European countries, U.S.A. developing of newly industrialized countries and Japan. Management of Multinational firms.

Module III : Globalization of Indian Economy. Liberalization and globalization of Indian business. India's multinationals, Indian laws and policies relating to investment in India by international firms and outside India by Indian firms.

MSV820 Contemporary Issues in IT Management

1 Credit (1-0-0)

The contents of the course around a selected advanced topic in information technology and systems.

MSL821 Strategy Execution Excellence

3 Credits (3-0-0)

Maximize your leadership potential by expanding your management skills through this one-year graduate certificate management program. This comprehensive program offers you the opportunity to broaden your perspective on salient management responsibilities and skills in key sectors such as health care, not-for-profit, community services, and technology and trades. Students must also participate in two weekend residency (virtual or on-campus) activities. This program enables you to leverage your existing career and educational

experiences to move into management positions. You will take a series of carefully selected business courses that will build and enhance your skills in critical areas of management such as finance, marketing, human resources, and leadership. In addition, you will have the option to select courses from specific industry streams-health care, community services, not-for-profit, and trades/technology. These courses are designed to provide industry-specific perspectives that will enhance your employability and career advancement.

MSV821 Contemporary Issues in Operations Management

1 Credit (1-0-0)

The content of the course around a selected advance topic in Operations & Supply Chain Management.

MSL822 International Business

3 Credits (3-0-0)

Pre-requisite(s): MSL301 & MSL302

Module I : Key Issues in International Business. Socio-cultural, economic and political forces facing business. International sourcing. Understanding the determinants of competitive advantage in international business at the national, industry and firm level. Global forces transforming international business. Multinational Corporation. Problems and Prospects in an International Environment, competitive and cooperative business strategy.

Module II : International Business Strategy of Indian Industry. Competitive position of key Indian Industries. Entry strategies for Indian firms: Joint Ventures, strategic/technical alliances/collaboration. Strategies employed by Indian firms to develop and sustain international business.

Module III : Globalization Strategy. Globalisation strategy, strategies of Multinational Corporation, implications for functional strategies: marketing, HR, planning, organisational structure, production, Global Information Systems, Strategy Alternatives for Global Market entry and expansion, International negotiations.

MSV822 Contemporary Issues in Economic Policy

1 Credit (1-0-0)

The course will concentrate on contemporary important economic policy issues. The specific topics will be of current economic policy interest. The topics covered are to include some of the following topics but not limited to: 1. Fiscal Policy Issues, Taxation and Inter State Relations 2. Monetary Policy and Exchange Rate Frameworks 3. Issues Related to Poverty and Inequality 4. Financial Integration and Currency Unions 5. International Trade Policies, Globalization and Implications on Welfare 6. Technological Change and Innovations 7. Climate Change and policy Alternatives.

MSL823 Strategic Change & Flexibility

3 Credits (3-0-0)

Module I : Patterns of Change and Flexibility. Patterns of change, liberalization, globalization and privatization, changes in Social Political and Economic environment, Technological and organizational change. Changes in customer requirements. Impact of change of business and workforce. Need for flexibility, concept of Strategic Flexibility: Openness, Adaptiveness, Change, and Resilience. Understanding the process of strategic change. Managing chaos strategically. Regenerating strategies.

Module II : Revising Strategies Postures. Corporate restructuring, Alliances, joint ventures, acquisitions and merges. Reorganising the firm, the impact of mergers and acquisitions on organizational performance. Management of continuity and change, Blue Ocean strategy.

Module III : Energising Strategies Change. Reengineering the corporation, identification of key business processes. Organization of the future. Implementing Strategic Change. Transforming the organization. Sustaining change. Consolidating gains and producing more change. Anchoring new approaches in the culture. Leading a high-commitment high-performance organization. Organization Vitalizations

MSL824 Policy Dynamics & Learning Organization

3 Credits (3-0-0)

Module I : Learning Organization. Emergence of learning organization. Strategies for organization learning, using Feedback, shared vision, team work, personal mastery, mental models, systems thinking, role of leader, organizational dynamics. Soft Systems Methodology application to policy formulation. Flexibility in policy strategy. Strategy formulation in a learning organisation, clarifying vision and opportunities for change in a learning organization.

Module II : Micro World and Policy Dynamics. Systems-linked organization model. Micro world for policy learning. System Dynamics modeling applied to policy formulations, conceptual model. The language of systems thinking links and qualitative system dynamics, Flexibility Influence Diagram, Collaboration Diagram, Archetypes, leverage points, Integrative simulation models.

Module III : Frontiers. Role playing games and case studies to develop principles for successful management of complex strategies in a dynamic world. Strategic Management game for policy planning, Interactive Planning. Strategic issues such as business cycles, market growth and stagnation. And diffusion of new technologies. Knowledge management in learning organizations.

MSV824 Contemporary Issues in Strategic Management

1 Credit (1-0-0)

The course addresses a number of current issues in strategic management, including but not limited to such topics as competitive analysis, mergers and acquisitions, managerial ethics, global strategy, and corporate culture. Emphasis is placed on the development of critical thinking skills.

MSL825 Strategies in Functional Management

3 Credits (3-0-0)

Module I : Linkage of corporate and Business strategy with various Functional strategies, Flexibility in Functional Strategies. Marketing Strategy, financial Strategy.

Module II : Manufacturing Strategy, IT Strategy, Human Resources Strategy.

Module III : Technology Strategy, Quality and Productivity Strategy, Environmental Strategy.

MSL826 Business Ethics

3 Credits (3-0-0)

Module I : Ethics in Business. Historical perspective, culture and ethics in India, codes and culture. Economics and the Environment: green business, Ethics and Competition. The ethical code, social audit. A framework for analysis and action. The sphere of personal ethics: consequences, rights and duties, virtue and character. Role of objectivity, practicability, judgement and balancing acts. The individual and the corporation.

Module II : Ethical Responsibilities. Ethical responsibilities of economic agents: role obligations, obligation to shareholder, rights and, obligations to customers, obligations to pay taxes. Environmental protection. Corporate accountability, Ethical conflicts, concern for the locality, Attitude to labour. Ethics and Government policies and laws.

Module III : Ethics in Functions. Ethical responsibilities of organizations leader: power, leadership. Obstacles to ethical conduct. Pressures for conformity. Evaluation and rewards. Job pressures and issues. Organizational change. Ethics in use of Information technology. Intellectual Property Rights. Ethics in Marketing. Ethics of advertising and sponsorship. Freedom Vs State Control. Acquisitions and Mergers, Multinational decision making: Reconciling International norms.

MSV826 Frontiers in OB & HR Management

1 credit (1-0-0)

The contents of the course would be built around the particular nuance and/or emerging frontier.

MSL827 International Competitiveness

3 Credits (3-0-0)

Module I : Introduction to Competitiveness. Background,

Need, Basics, Myths; Global Perspectives, Context, Definitions, Benchmarking & Key Issues; Related concepts: Excellence, Value Creation; Competitiveness at Different Levels.

Module II : Evaluating & Planning for Competitiveness. Frameworks of Competitiveness & Strategy, Evaluating Competitiveness, Enhancing Competitiveness, Competitiveness Processes & Initiatives, Leadership Dimension, Cases.

Module III : Practitioners Perspectives. Business Models for Competitiveness, Functional (e.g. HR, Operational, Financial, Technological) Linkages, Partnerships/Cooperation for Competitiveness, Emerging Issues/ Practices.

MSV827 Frontiers in Finance

1 Credit (1-0-0)

The contents of the course would be built around the particular nuance and/or emerging frontier.

MSL828 Global Strategic Management

3 Credits (3-0-0)

Module I : The Process of Globalization and Global Strategy. Globalization of markets and competition, globalization and localization, Diagnosing Global Industry Potential, Designing a global strategy, Making Global strategies work, Global strategic alliances, M&A.

Module II : Regional Strategy and Entry Strategy. Regional Strategy, Emerging Markets Assessing Country Attractiveness, Entry Strategies: Subsidiaries, acquisitions, joint ventures, Licensing, Franchising, Agents and Distributors.

Module III : Managing Globally and Future Challenges. Designing a global organization, Global Marketing and Operations, Cross Cultural Management, Leadership and Global manager, Globalization and the Internet.

MSV828 Frontiers in Information Systems Management

1 Credit (1-0-0)

Series of focused topics in any emerging area of Information Systems. The topics may evolve based on the expertise of the expert invited for delivering the course, with due discussion with the area. The topics would cover emerging issues in information systems, from both a theory and practice point of view. Further it may expose the participants on the challenges and critical success factors in the domain being explored.

MSL829 Current and Emerging Issues in Strategic Management

3 Credits (3-0-0)

(Relevant current and Emerging Issues)

MSL830 Organizational Structure and Processes

3 Credits (3-0-0)

Pre-requisite(s): MSL301 & MSL302

Module I : Organisational structure- classical and neoclassical theories. Strategy and structure. Modern Organizational theory- systems view of organisation and integration. Micro, intermediate, macro environment. Participative structures.

Module II : Work culture and organization processes. Decision processes, balance and conflict processes. The process of role and status development. Influence processes and technological processes. Capacity development in organizations.

Module III : Interface of structure and processes- structural functionalism; Allport and Event- Structure theory. Organizational Governance- organizations as a subject of political enquiry, Models of organizational governance. Making and breaking patterns.

MSL831 Management of Change

3 Credits (3-0-0)

Pre-requisite(s): MSL301 & MSL302

Module I : Process of change and organization theory and practice. Elements of change. Achieving Systematic change. Domains of systematic change-strategy, technology, structure and people. Planning for change.

Module II : Change and the use of power. Nature and sources of power. Leadership and change- Transactional vs. Transformational change. Change cycle including participative and coerced change.

Module III : Change through behaviour modification. Positive and negative reinforcement. Training for change. Managing conflict. Implementing change. Adjustment to change and organising for growth. Prerequisites and consequence of change. The change Dynamics.

MSL832 Managing Innovation for Organizational Effectiveness

3 Credits (3-0-0)

Pre-requisite(s): MSL301 & MSL302

Module I : Elements of creativity person, creative organization, nature of innovation. Assessing creativity. Tools and techniques for enhancing creativity. Innovation and risk.

Module II : Managing social equity and organisation efficiency paradox, blocks to creativity, methods to overcome the blocks. Introducing creativity in organisation. Structure and creativity. Work culture and innovation.

Module III : Practices of creativity and intervention strategies-organization excellence: Criteria and practice-innovation and quality, Innovation and BPR/appraisal system- interventions. Innovation and competitiveness.

MSV832 Frontiers in Strategic Management

1 credit (1-0-0)

The contents of the course shall be around a selected advanced topic in strategic management area

MSL833 Organizational Development

3 Credits (3-0-0)

Pre-requisite(s): MSL301 & MSL302

Module I : Organisation Development- nature and scope. The generic and contextual element of developing organisation. Introduction to process change. Theories, strategies and techniques of organizational diagnosis for improving organisation's problem solving and renewal process, legacy factors and organizational growth.

Module II : Coping with environmental change. Socio-cultural dimensions of work and behaviour, Environmental analysis and impact. Diagnosis of the ongoing process from symptoms to causes. Organisation development and intervention strategies.

Module III : Personal change. Laboratory learning techniques. Managerial Grid. Sensitivity training. Transactional analysis. Inter-group and team building interventions. Management by objectives. Total system interventions-stabilising change.

MSL834 Managing Diversity at Workplace

1.5 Credits (1.5-0-0)

Pre-requisite(s): MSL301 & MSL302

The course introduces students to the relational framework towards diversity management by discussing the macro, meso and micro factors influencing DM. Through analysis of the different organizational approaches and initiatives towards diversity management, it highlights ways in which inclusive workplaces can be created and diversity leveraged for business performance.

MSL835 Labor Legislation and Industrial Relations

3 Credits (3-0-0)

Pre-requisite(s): MSL301 & MSL302

Module I : Introduction of industrial relation and a systematic view of personnel. Labour Relations. Introduction to Indian Trade Unionism. Industrial relations and conflict in industries. Introduction of Labour Regulation Act, Factories Act, Trade Union Act, and Safety Act.

Module II : Role of Industrial Legislation. Introduction of Industrial Dispute Act. Different jurisdiction of Labour Court. Issues in recognition of unions. Tribunal and national tribunal. Strategies for resolving Industrial Conflict, Collective bargaining. Works committee and joint consultative committee, Negotiation process.

Module III : Influence of Government regulations. Third party intervention in industrial disputes. Rules of grievances. Discipline in Industry. Contribution of tripartite bodies. Labour Welfare Participative Management. Workman's Compensation Act. Productivity in Industry. Healthy industrial relations and economic development.

MSL836 International Human Resources Management

1.5 Credits (1.5-0-0)

Pre-requisite(s): MSL301 & MSL302

The course would cover issues pertaining to selecting, managing and developing international workforce. It would sensitize students to the cross-cultural issues faced by global organizations and emerging issues within international HRM. Lectures, small group discussions and case study analysis would be the primary teaching methods adopted in this course.

MSL837 Entrepreneurial Finance

3 Credits (3-0-0)

Pre-requisite(s): MSL 707 and 708 for MBA students, MSL302 for B.Tech. students

The course would broadly cover the entrepreneurial environment, organizing and operating the venture, planning for the future, creating and recognizing venture value, structuring financing for the growing venture and finally the exit and turnaround strategies. Among these broad six areas, there would be specific content and deliverables.

MSL838 Fixed Income Securities

3 Credits (3-0-0)

Pre-requisite(s): MSL708 for MBA, MSL302 for B. Tech students

The course covers types of debt securities, who are the market participants in the debt market, regulatory framework, and how debt market is linked to the macroeconomic environment. It covers basic features of the debt market instruments, their valuation, yield measures, duration and convexity measures, and term structure of interest rates. The course covers simple bonds, bonds with embedded options and asset-backed securities, arbitrage-free valuation, reduced and structure models of credit risk, interest rate derivatives, and construction of bond portfolios and how performance of bond portfolios is evaluated.

MSL839 Current and Emerging Issues in Organizational Management

3 Credits (3-0-0)

Pre-requisite(s): MSL301 & MSL302

(Relevant current and Emerging Issues)

MSL840 Manufacturing Strategy

3 Credits (3-0-0)

Pre-requisite(s): MSL301 & MSL302

Module I : Manufacturing and operations strategy-relevance and concepts. Strategic issues in manufacturing & operations, Capacity planning, International innovations in manufacturing. Choice of technology and manufacturing process in the prevailing environment.

Module II : Technology-manufacturing process interfaces with marketing, engineering, quality, purchasing, finance and accounting. Inter-relationship among manufacturing manager and their suppliers, customers, competitors, superiors and production workers.

Module III : Strategic implications of Experience Curve. Focused manufacturing-green, lean and mean. Strategic issues in project management and implementation of manufacturing policies. Perspectives of Manufacturing Strategy. Case Studies.

MSL841 Supply Chain Analytics

3 Credits (3-0-0)

Pre-requisite(s): MSL301 & MSL302

This course will introduce students to supply chain analytics by learning the three aspects of supply chain planning and design. The

first one is Descriptive Analytics of supply chain, which focuses on fundamental tools and methods on data analysis and statistics, visual representations of data and data modeling. The second major focus is on Predictive Analytics of supply chain, which develops approaches for building and analyzing predictive models, applying regression, forecasting techniques, simulation and risk analysis, etc. The third major focus is on Prescriptive Analytics of supply chain, which aims at arriving at optimal decisions for the different future scenarios in the supply chain.

MSL842 Supply Chain Modeling

3 Credits (3-0-0)

Pre-requisite(s): MSL301 & MSL302

This course primarily deals with understanding and analyzing problems underlying the design, planning and operation of supply chains, with a special emphasis on the logistical and other issues related to the material and the information flow in these systems. The main objective of the course is to introduce methodological description of the various issues in supply chain related to design, planning and control problems. Mathematical models and techniques are used to support the analysis of the identified issues. It also develops understanding of some basic tools that can support the functioning of the analytical methodologies.

MSL843 Supply Chain Logistics Management

3 Credits (3-0-0)

Pre-requisite(s): MSL301 & MSL302

Module I : Perspective of Supply Chain Logistics Management. Logistics concept, role and scope; Logistics Environment- Integrating Logistics of Supply, Logistics of Production and Logistics of Distribution. Internal and external factors for logistics strategy, Operational Resources of logistics (personnel, warehouse means of transport, warehouse transport aids, organizational aids, material stocks, and area/spare) Effective supply chain management, customer networking and manufacturing, Risk Pooling, Postponement, cross docking in supply chain, CPFR, IT-enabled supply chains value of Information, Coordination in SCM.

Module II : Logistics Activity Mix. JIT and Logistics, Synchronised manufacturing. Purchasing and Materials Management. Distributional logistical systems and facilities-single stage or multistage, warehouse(s), their number, location and allocation, Automated Warehousing, Materials Handling and Packaging. Simulation aided planning of conveyor and warehousing systems.

Module III : Supply Chain Logistics Mix Management. Logistical Connectivity: Transportation modes, rate structure, legal aspects; maintenance, spares and repairs; test and support equipment, Routing of freight flows. Management and Organization of the Logistics Systems; Organization, Information and cost control; Logistical information Systems, Computer aided logistics management. Case Studies.

MSL844 Systems Reliability, Safety and Maintenance Management

3 Credits (3-0-0)

Pre-requisite(s): MSL301 & MSL302

Module I : Reliability, Safety, Risk Assessment Perspective. Introduction to reliability, availability and safety engineering and management. Select statistical concepts and probability distributions. Optimization techniques for systems reliability, availability and safety. Reliability, availability, safety and maintainability. Risk assessment and management for reliability and safety.

Module II : Maintenance Planning and Control.

Maintenance management objectives and functions. Classification of Maintenance system. Maintenance Planning and Scheduling. Issues of Replacement versus reconditioning and imperfect repair maintenance models. Spare parts Inventory Planning and Control for single and multi-echelon systems. Diagnostic tools of failure analysis: Failure Mode Effect and Criticality Analysis, Fault Tree Analysis.

Module III : Information System for Reliability, Safety and Maintenance Management.

Organizational aspects and a computer aided management information system for reliability, safety and maintenance. Life cycle costing and cost management for maintenance. Human factors in maintenance, Maintenance Manpower Planning. Case Studies.

MSL845 Total Project Systems Management

3 Credits (3-0-0)

Pre-requisite(s): MSL301 & MSL302

Module I: Project Systems Management: a life cycle approach, project characteristics; project life cycle phases: conception, definition, planning and organising, implementation and project clean up. Project feasibility analysis. The project manager: role and responsibilities, Team Building and Conflict Management. Tools and techniques for project management. Environmental impact analysis of a project.

Module II: Network techniques for project management-PERT, CPM and GERT. Accounting for risk, uncertainty and fuzziness. Time cost tradeoffs and crashing procedures. Multi project planning and scheduling with limited resources. Multi objective, fuzzy and stochastic based formulations in a project environment.

Module III: Funds planning, performance budgeting and control. Project materials management. Pricing, estimating, and Contract Administration and Management, Building and Bid evaluation and analysis. Project implementation and monitoring, Project management information and control systems. Project systems management performance indices. Software Packages application for Project Systems Management. Case studies.

MSL846 Total Productivity Management

3 Credits (3-0-0)

Pre-requisite(s): MSL301 & MSL302

Module I: Total Productivity overview; meaning, relevance and scope for productivity and effectiveness. Productivity conceptualisation. Productivity mission, objectives, policies and strategies. Productivity environment. Corporate culture, management styles, employees participation, trade unions and role of governmental agencies. Productivity measurement, monitoring and management both at micro and macro levels. Corporate and annual productivity plans.

Module II: Benchmarking: Management issues, modelling, tools and techniques; indicators for evaluation of manufacturing, business or services organizational performance and its measurement.

Module III: Productivity Improvement Techniques: modifying organizational characteristics and work characteristics. Work study, Value Engineering, Waste Management. Human resource development strategies to increase productivity. Managing technological change. Interfaces of Productivity with Quality, Reliability and Safety. Management commitment and involvement for higher productivity. Case Studies.

MSL847 Advanced Methods for Management Research

3 Credits (3-0-0)

Pre-requisite(s): MSL301 & MSL302

Introduction to management research, types of management research, research designs, Portfolio of management research methodologies involving qualitative and quantitative tools, optimization approaches, Multi-criteria decision making tools, case studies, interpretative models, soft system methodology, simulation, etc. Design of a questionnaire-based survey instrument, development of data measurement, scale development, testing the validity and reliability of data, sampling techniques, descriptive statistical analysis, inferential analysis, sampling techniques, sampling distribution, hypothesis testing, ANOVA, factor analysis, correlation, regression : OLS, Logic, Tobit, Probit, Discriminant analysis, Co-integration, unit root testing, Granger, causality, VAR, GARCH and its variants. Structural equation modelling and other related research tools. Portfolio of optimization tools such as linear programming, goal programming, integer programming, Data Envelopment Analysis for designing a management research. Case study approach with SWOT, SAP-LAP, value chain, PEST, etc. AHP, ANP modeling of risk and uncertainty in management, real life case development with appropriate research design.

MSL848 Applied Operations Research

3 Credits (3-0-0)

Pre-requisite(s): MSL301 & MSL302

The objective of the course is to provide the students about the application of Operations Research (OR) in various functional areas of business such as operation, supply chain management, materials management, marketing, finance, and human resource. The entire course is a case based where the participants will be given a case. Participants will be asked to tackle the case problem without using OR using their own experience or any other logical method and then they will be asked to tackle the same situation applying OR. At the end of the course they will appreciate how OR can help the decision makers in an efficient decision making process.

MSL849 Current and Emerging Issues in Manufacturing Management

3 Credits (3-0-0)

Pre-requisite(s): MSL301 & MSL302

(Relevant current and Emerging Issues)

MSL850 Management of Information Technology

3 Credits (3-0-0)

Pre-requisite(s): MSL301 & MSL302

Module I: The Strategic Framework for IT Management. Emerging information technologies: IT for competitive advantage; IT for internal effectiveness; IT for inter-organizational linkage; Module II Strategy Development and Planning Techniques.

Module II: IT Planning (CSFs, Scenario analysis, Linkage analysis, Enterprise modeling); Strategy formulation techniques; Nolan's stage model and revised models for Nolan's stages; IT investment decisions; methods for evaluating IT effectiveness; IT enabled business process redesign.

Module III: Strategic Issues Related to IT Management. Relating IT to organizational leadership, culture, structure, policy and strategy; programmer productivity; Managing legacy systems; evaluating centralization-issues; IT-forecasting.

MSL851 Strategic Alliance

1.5 Credits (1.5-0-0)

This is an advanced strategy course that focuses on the role of strategic alliances and inter-firm networks in the overall strategic adaptation process of the firm. Inter-firm networks and strategic alliances have emerged as important strategic options for navigating survival and creating competitive advantage in times of high velocity turbulent environments characterized by pressures to master rapid technological developments, counteract new competitors and the never ending need to acquire and master new capabilities (technical and managerial). The course explores crucial success factors that distinguish successful from failing strategic alliances. The course utilizes case discussions supplemented with readings, lectures, and conceptual discussions.

MSL852 Network System: Applications and Management

3 Credits (3-0-0)

Pre-requisite(s): MSL301 & MSL302

Module I: Networking fundamentals. Communication fundamentals (transmission and transmission media; communication techniques; transmission efficiency) Wide area networks, local area networks, ISDNs; OSI architecture, IBM's SNA, Digital's DNA, Internetworking; network applications- EDI, Email, file transfer, conferencing, Enterprise networking.

Module II: Networking technologies and applications. Design and development of enterprise network; Web-based application development, Design of large-scale intranets, Network and systems management issues, Remote access to computer resources, Network and system security.

Module III: Managing networks. Preparing for doing business on the internet; Choosing and costing networks and network services; network management requirements; network performance indicators; performance monitoring.

MSL853 Software Project Management

3 Credits (3-0-0)

Pre-requisite(s): MSL301 & MSL302

This course may expose the participants to the following topics: IT Evolution and its implications for business, IT Productivity Paradox - Issues and Implications, Impact of IS in the Networked Economy, Reasons for success and failure of IT projects, Disaster planning, Approaches to IS Development (e.g. Portfolio approaches), Technology Justification and Alignment Models, Strategic impact of IT/IS, Role of the CIO and challenges in business continuity.

MSL854 Big Data Analytics & Data Science

1.5 Credits (1.5-0-0)

Pre-requisite(s): MSL301 & MSL302

This course may expose the student to the following themes within the discipline: Introduction to Data Science and Data Scientists, Introduction to Big Data, Theories in Data Science, Big data technologies, Large query data sets and associated theories, Exploring the Hadoop Ecosystem, Information management in Big Data and Emerging Issues.

MSL855 Electronic Commerce

3 Credits (3-0-0)

Pre-requisite(s): MSL301 & MSL302

This course may expose the participants to the following topics: Introduction to e-commerce, B2B E-commerce models, B2C E-Commerce models, Mercantile processes, E-Commerce Infrastructure and Capacity Planning, Web Portals & Services, Trading, Pricing, Auctions, Bartering & Negotiations, Advanced and emergent topics in E-Commerce, Inter-organization information systems, e-procurement systems, e-fulfillment systems, e-SCM, Risk management in E-commerce. Hands on training may also be provided.

MSL856 Business Intelligence

3 Credits (3-0-0)

Pre-requisite(s): MSL301 & MSL302

The course will consist of the following: Introduction to data mining, types of data mining systems, data preprocessing and data warehouses (OLAP/OLTP), Data Cube Computation and Data Generalization, Mining Frequent Patterns, Associations, Correlations, Classification, Prediction, Clustering, time series and sequence data analysis, Graph Mining, Social Network Analysis, and Multirelational Data Mining, Mining Object, Spatial, Multimedia, Text, and Web Data, Applications and trends.

MSL858 Business Process Management with IT

1.5 Credits (1.5-0-0)

Pre-requisite(s): MSL301 & MSL302

This course may expose the participants to the following topics: Concepts of process and business process, Processes and workflow management systems, Concepts and evolution of BPM technologies, Impact of IT in BPM and its road map, BPM Cycle, Process deployment, Process monitoring, Process optimization using IT tools, Flowcharting and business process mapping and emergent issues in BPM/BPR technologies. Other relevant topics within the subject domain may also be explored.

MSL859 Current and Emerging Issues in IT Management

3 Credits (3-0-0)

Pre-requisite(s): MSL301 & MSL302

(Relevant current and Emerging Issues)

MSL860 Derivatives

3 credit (3-0-0)

Pre-requisite(s): MSL708 for MBA, MSL302 for B. Tech students

This course covers how derivative markets function, how derivative securities are priced, their usage and the associated risks. Specifically

this course focuses of forwards and futures, and options of stocks, stock indices, currencies, and futures options. It covers binomial model and Black-Scholes-Merton model for option pricing, trading strategies using options, Greek letters, and volatility smiles. It covers energy and commodity derivatives also.

MSL861 Market Research

3 Credits (3-0-0)

Pre-requisite(s): MSL301 & MSL302

Module I: Research concepts; exploratory, descriptive and conclusive research. The market decision-making process and the need of different types of research. Types of marketing problems and type of marketing research activity. Sources of data; use and appraisal of existing information.

Module II: Information from respondents, sampling design, scaling techniques and questionnaire design, interviewing, mail surveys. Information from experiment, experimental design for marketing, Motivational research, Advertising research, Analysis and reporting.

Module III: Marketing information systems, Structure and design, its role in planning and control; the place of marketing research.

MSL862 Product Management

3 Credits (3-0-0)

Pre-requisite(s): MSL301 & MSL302

Module I: The product in corporate life, Corporate and product objective, product management role, responsibility, scope and functions, product strategy and policy, optimum product pattern/line range.

Module II: New product development and launching. Challenge of change-opportunity and risk-product innovation, modification, addition and elimination product proposals-sources, generation, processing and selection. Establishing techno-economic feasibility product testing and test marketing. Developing the strategy and the plan. Implementing the plan, coordination and control. Brand identity, Image, Equity, Brand Plan and Management, New Product Development Process. Brand and Product launch plan.

Module III: Organization for Product Management, Marketing manager-product manager-brand manager concept, approaches and organizational role, product manager-functions and tasks-tools and techniques. Brand extensions, acquisitions, Brand value, Consumer insight. Strategies brand management.

MSL863 Advertising and Sales Promotion Management

3 Credits (3-0-0)

Pre-requisite(s): MSL301 & MSL302

Module I: Mass communication theory and practices, marketing and promotion mix- interrelationship and interdependence advertising. Sales Promotion, Publicity and Public Relations- Scope, Objectives, activities and creative role. Advertising, objectives tasks and process, market segmentation and target audience-Message and copy development. Mass media, selection, planning, budgeting and scheduling. Integrated programme and budget planning. Implementing the programme, coordination and control. Advertising Agencies in India, their services and terms, advertisement campaign development, Agency selection and appointment; Agency Organization and operation, Getting the best of the agency services. Analysis of effectiveness of advertisement and promotional campaign.

Module II: Why and when sales promotion support, Sales promotion activities; Consumer Oriented-Sales channel Oriented-Sales staff oriented, Planning, budgeting, implementing and controlling campaigns. Advertisement development brief.

Module III: Valuation and measurement of advertising and sales promotion effectiveness, Company organization for advertising: sales manager, Sales Promotion Manager, Market Development Manager-Role of Tasks, advertising ethics, economics and social relevance. The Public Relations Activities, Public relations and mass media. Media planning and budgeting control.

MSL864 Corporate Communication

3 Credits (3-0-0)

Pre-requisite(s): MSL301 & MSL302

Corporate communications is a strategic tool that is leveraged to gain strategic advantage. Organizations use it to lead, motivate, persuade and inform both employees and outside stakeholders. How organizations set objectives, define messages and reach their employees, extended audiences, the media and customers, and how the company or group articulates its vision and brings its values to life, will all be discussed.

The course will familiarize students with some of the issues that specifically affect organisations and challenge the corporate communications function. Some of these issues include a change in CEO, mergers and acquisitions, imposition of government regulation and public pressure groups. Focus will be placed on crafting corporate messages for internal and external stakeholders. Specific subject.

MSL865 Sales Management

3 Credits (3-0-0)

Pre-requisite(s): MSL301 & MSL302

Module I: Organisational framework of the field sales force. Types and methods of field sales organisations-Career in Field Sales Management. Field Sales Manager- coordinating and controlling the Marketing mix, Tasks and responsibilities, team relations with Salesman and interaction and reporting relationship with Top Management. Operating environment for Field Sales Managers. Sales forecasting.

Module II: Sales Information and Planning, The qualities and role of a Field Sales Manager- Hierarchy of objectives and goals, concept of sales strategies and tactics; types of Planning. Marketing Intelligence and Sales Management. Relationship and contribution of Marketing Research to the sales development as decision making process. Designing and planning of sales territories, procedure for designing sales territories. Determining sales manpower requirements to establish sales territories- Recruiting salesman- selection process and system. Distribution and channel selection & Management.

Module III: Operational Management, Staffing: Its advantages, responsibility for staffing, tools and methods of selection. Sales training: Its objectives, programme content, Methods of training, concepts of territorial management for field sales force. Measurement and control: General considerations governing evaluation and sales performance and control. Sales audit, Sales budgeting, Key account management, Route Planning and control. Sales Promotion Customer relationship management.

MSL866 International Marketing

3 Credits (3-0-0)

Pre-requisite(s): MSL301 & MSL302

Module I: International marketing-its scope and tasks- world economy prospects and Challenges; India's external trade. Analysis of export performance. Why all organisations cannot go global Shipping terms and international trade terms. Information needs of exports. Costing and pricing in international trade. Advantages and disadvantages of globalisation.

Module II: Strategic export planning. Handling an export transaction. Export marketing Checklist; Selection of Markets: Choosing Markets; Export pricing; Management of export logistics. Documentation for export; processing of an export trade. Sales forecasting in international trade, Identifying geographical territories for expansion. Cultural factors affecting business in global market.

Module III: Export credit system pre-shipment and post-shipment, finance, medium and long term credit financing; ECGC; Transportation and shipment of cargo; Marine insurance of cargo; procedure for claiming rebate of excise duty. Import replenishment licensing procedures. Generalized scheme of preferences. Sourcing and Transfer pricing mechanism. WTO related issues and IPR related issues impacting global trade.

MSL867 Industrial Marketing Management

3 Credits (3-0-0)

Pre-requisite(s): MSL301 & MSL302

Module I: Industrial marketing and Environment. Application of

industrial buyer behaviour theories. Marketing plan to implement the marketing concept.

Module II: The new product development process. Personal selling (negotiations, systems selling, targets setting, fact finding, training); sales communications.

Module III: Marketing Research for industrial product Marketing control (variance analysis audit). Industrial purchase behaviour and processes, new product launch. Forecasting methods.

MSL868 Digital Research Methods

1.5 Credits (1.5-0-0)

Pre-requisite(s): MSL301 & MSL302

The course will have the following coverage: Internet as a research medium; Research design; Sampling methods; Online surveys; Nonreactive data collection; virtual ethnography; Online focus groups; secondary qualitative data analysis; blogs & videos as source of data; data analysis approaches; tools.

MSL869 Current and Emerging Issues in Marketing

3 Credits (3-0-0)

Pre-requisite(s): MSL301 & MSL302
(Relevant current and Emerging Issues)

MSL870 Corporate Governance

1.5 Credits (1.5-0-0)

Pre-requisite(s): MSL301 & MSL302

The course would broadly be divided into three modules. Module 1 would provide a global perspective to the students on the concept of corporate governance. Module 2 would focus on India and present the framework of corporate governance for Indian organizations. Module 3 would focus on corporate social responsibility (CSR) and its manifestations. Apart from the regular lectures and assignments, there would be a course pack provided to the students containing international and national reports, articles, studies and cases to help them build an international perspective through the self-study component.

MSL871 Banking and Financial Services

1.5 Credits (1.5-0-0)

Pre-requisite(s): MSL301 & MSL302

The course will comprise of two broad sections; banking and financial services. Banking portion will cover banking sector reforms, bank management, financial statements of banks, sources and uses of bank funds, credit monitoring and management by banks, bank capital and Basel norms. Financial services will encompass both fund based and fee based services that are an integral part of modern financial systems; it will include lease financing, hire purchase financing, consumer credit, factoring, housing finance, investment banking, credit rating, stock broking, depository and custodial services. The course work will encompass problem solving on relevant topics and inputs from real life cases to give a practical insight to the theoretical concepts.

MSL872 Working Capital Management

3 Credits (3-0-0)

Pre-requisite(s): MSL301 & MSL302

Module I: Nature and Financial of Working Capital. Nature of Working Capital, Trade-off between Profitability and Risk, Determinants of Working Capital. Factoring as a Sources Finance. Forecasting Working Capital requirements. Sources of financing Working Capital. Factoring as a source of finance. Bank credit and working capital Finance. Approaches to determine Financing Mix. Working Capital Leverage. Cases and Practical Problems.

Module II: Current Assets Management. Cash Management, Inventory Management, Receivables Management. Cases and Practical Problems.

Module III: Analysis aTools and New Development. Operating Cycle, Ratio Analysis, Funds-flow Analysis and Cash-Flow Statement as tools of Working Capital Management. Recent changes and new developments. Practical Problems.

MSL873 Security Analysis & Portfolio Management

3 Credits (3-0-0)

Pre-requisite(s): MSL301 & MSL302

Module I: Investment Environment. Saving and Financial flows, Financial Intermediation, Investment in Corporate Securities and other Investment Outlets, New Issue market and Secondary Markets. Sources of investment information. Theoretical framework for investment Decision. Regulatory Framework of Securities Markets in India.

Module II: Valuation of Securities. Valuation of Variable Income Securities (Equity Shares): Theory of Valuation-Earnings and Dividend Model. Fundamental Analysis, Aggregate Economic Analysis, Industry Analysis, Company Analysis, Technical Analysis, Growth Shares, Under and Overvalued Shares. Analysis of Fixed Income Securities like Preference Shares, Debentures/Bonds and other Financial Instruments. Interest Rate structure and yield to Maturity Curve. Convertible Bonds: Warrants and Options.

Module III: Portfolio Management. General principles. Measures of Risk and Return, Required Rate of Return and CAPM, Markowitz Portfolio Theory. Efficient Capital Market Theory. Alternative Efficient Market Hypotheses. Constructing the Optimum Portfolio.

MSL874 Indian Financial System

1.5 Credits (1.5-0-0)

Pre-requisite(s): MSL301 & MSL302

This course is an introduction to the Indian financial system and tends to appraise students with its components, functions and integration of its sub components with each other. It covers different types of financial institutions, financial markets and financial instruments and services through which the financial system operates. Also, the students would develop an understanding of the role played by the different financial intermediaries in developing a robust financial environment for any country. The course will also give insight into the role played by financial market regulators and the challenges being faced by them in the modern internationally integrated economies.

MSL875 International Financial Management

3 Credits (3-0-0)

Pre-requisite(s): MSL301 & MSL302

Module I: Foreign Exchange Market and Risk Management : Environment of International Financial Management: Balance of Payments. Means of International Payments, Foreign Exchange Market, Currency Futures and Options Markets, Foreign Exchange Risk Management, Political Risk, Interest Rate Risk.

Module II: Financing of International Operations : Determination of Exchange Rate, Exchange Market and Arbitrage, Exchange Rate Control, Financing of Exports and International Investments, International Monetary Systems, European Monetary System, International monetary and Financial Institutions.

Module III: Financial Management of MNCs : Capital Budgeting Decisions for Multinational Corporation, Financing Decisions- Cost of Capital and Financial Structure, Working Capital Management and Control, International Banking, International Transfer Pricing.

MSL876 Economics of Digital Business

1.5 Credits (1.5-0-0)

Pre-requisite(s): MSL301 & MSL302

This course may expose the participants to the following topics: Impact of diffusion of ICTs in Business and People, Trade-offs & Network effects, Economics of Data communication including pricing, Firms, Networks, Centralization, Decentralization in 2 sided markets, Factors affecting organizational structure and size, Dynamics of Open Source and Open Innovation, Information, Search, Switching and Price dispersion, Information goods pricing and bundling. Other similar themes may also be explored.

MSL877 Electronic Government

1.5 Credits (1.5-0-0)

Pre-requisite(s): MSL301 & MSL302

This course may expose the participants to the following topics: Introduction to E-Governance, E-Governance models and frameworks, E-Governance infrastructure and stages in evolution, Information Management in Electronic Governance. Issues in Emerging and Developing Economies, Selective Case Studies in E-Governance, Emerging initiatives in electronic governance, Role of policy. Other relevant topics within the subject domain may also be explored.

MSL878 Electronic Payments

1.5 Credits (1.5-0-0)

Pre-requisite(s): MSL301 & MSL302

This course may expose the participants to the following topics: Different business models in electronic payments, Digital certificates and certificate chains, Automated clearing and settlement systems, Banking systems and foreign exchanges, Other players in the ecosystem, E-Payment and Card security, Micro-payments, P2P Payments, Electronic Cash, Challenges and role of policy. Other relevant topics within the subject domain may also be explored.

MSL879 Current and Emerging Issues in Finance

3 Credits (3-0-0)

Pre-requisite(s): MSL301 & MSL302

(Relevant current and Emerging Issues)

MSL880 Selected Topics in Management Methodology

3 Credits (3-0-0)

*Pre-requisite(s): MSL301 & MSL302***MSL881 Management of Public Sector Enterprises in India**

3 Credits (3-0-0)

Pre-requisite(s): MSL301 & MSL302

This course will expose the participants to the following topics: Concepts of cloud computing and its impact, Technology Road Map to Cloud Computing, Virtualization, Practical usage of virtualization, Cloud Computing Frameworks and Deployment models. Cloud resource utilization and optimization, Cloud and Web Services, Service Model Architectures, SLA and QoS, Service Oriented Architecture and Cloud Computing.

MSL882 Enterprise Cloud Computing

1.5 Credits (1.5-0-0)

Pre-requisite(s): MSL301 & MSL302

This course will expose the participants to the following topics: Concepts of cloud computing and its impact, Technology Road Map to Cloud Computing, Virtualization, Practical usage of virtualization, Cloud Computing Frameworks and Deployment models. Cloud resource utilization and optimization, Cloud and Web Services, Service Model Architectures, SLA and QoS, Service Oriented Architecture and Cloud Computing.

MSL883 ICTs, Development and Business

3 Credits (3-0-0)

Pre-requisite(s): MSL301 & MSL302

The course will cover the following topics: Introduction, Development agendas and place of ICTs, ICTs as appropriate technologies, ICTs in education, health, industry & enterprises; ICT policy & regulations. Politics of open technology standards; ICT consulting for government; ICTs, Bottom of Pyramid & Business.

MSL884 Information System Strategy

3 Credits (3-0-0)

Pre-requisite(s): MSL301 & MSL302

This course may expose the participants to the following topics: IT Evolution and its implications for business, IT Productivity

Paradox - Issues and Implications, Impact of IS in the Networked Economy, Reasons for success and failure of IT projects, Disaster planning, Approaches to IS Development (e.g. Portfolio approaches), Technology Justification and Alignment Models, Strategic impact of IT/IS, Role of the CIO and challenges in business continuity.

MSL885 Digital Marketing-Analytics & Optimization

3 Credits (3-0-0)

Pre-requisite(s): MSL301 & MSL302

The course may cover the following topics: Introduction and Perspectives in internet marketing, Online consumer behaviour and technology adoption theories, Managing the Word of Web, Mapping online communities & networks, Online pricing mechanisms, Social Network Analytics & Optimization, Web Analytics and Optimization, Traffic analytics, Online campaign and channel management, Managing the Web 2.0, Search Engine & Social Media Optimization, SMAC, Social CRMs, Metrics for E-Commerce Analytics, KPIs, Revenue Analytics.

MSL886 IT Consulting & Practice

3 Credits (3-0-0)

Pre-requisite(s): MSL301 & MSL302

This course may expose the participants to the following topics: Trends in the IT consulting industry, IT consulting issues and pain points, Critical IT issues and their organizational contexts, Marketing and selling IT consulting projects, Project Entry Strategies, Contracting, Proposal Writing and making the sales pitch, Frameworks for technology evaluation. Frameworks for consulting intervention, change management and project closure, Implementation Planning for IT Projects, Managing Consulting Firms and Knowledge Management. Other relevant topics may also be explored.

MSL887 Mobile Commerce

3 Credits (3-0-0)

Pre-requisite(s): MSL301 & MSL302

This course may expose the participants to the following topics: Introduction to Ubiquitous computing, Mobile communication and emerging technologies, Ubiquitous business models and challenges, Security issues and information risk management in mobile commerce. Mobile services and location based services, Interface with Social Media and Cloud, Mobile banking and payment systems, Socio-economic development with m-Commerce, Mobile based services for e-governance. Introduction to mobile apps in the context of ICT ecosystem; explaining success of apps; app entrepreneurship; app economy, challenges of entrepreneurship and economy. Business models of app stores; mobile gaming; app customer segmentation; case studies.

MSL888 Data Warehousing for Business Decisions

1.5 Credits (1.5-0-0)

Pre-requisite(s): MSL301 & MSL302

This course may expose the participants to the following topics within this domain: Introduction to Database Management Systems, Hierarchical modelling, Multi-dimensional modeling of data, Design techniques and ETL, SQL. Data warehousing requirements for ETL; Data Warehousing Risks, OLAP and OLTP Management Issues, designing and supporting applications, Expanding a data warehouse. Other relevant topics within the subject domain may also be explored.

MSL889 Current and Emerging Issues in Public Sector management

3 Credits (3-0-0)

Pre-requisite(s): MSL301 & MSL302

(Relevant current and Emerging Issues)

MSL890 Financial Engineering

3 Credits (3-0-0)

Pre-requisite(s): MSL708 for MBA, MSL302 for B. Tech students
The course introduces forwards, futures, swaps, and options – how

these markets function, how these securities are priced, and purposes for which they are used by hedgers and speculators. It covers basic concepts in stochastic calculus, numerical procedures (including binomial trees, Monte Carlo simulation, and finite difference methods), value at risk measures, credit risk derivatives (valuation and usage), martingales pricing theory, interest rate derivatives (such as bond options, caps and floors), equilibrium and no-arbitrage models of the short-term interest rate, and advanced models (Heath, Jarrow, and Morton model, and LIBOR market model), and real options.

MSL891 Data Analytics using SPSS

1.5 Credits (1.5-0-0)

Pre-requisite(s): MSL301 & MSL302

MSL892 Predictive Analytics

1.5 Credits (1.5-0-0)

Pre-requisite(s): MSL301 & MSL302

This course may expose the participants to the following topics: Introduction to the different predictive analytics models, using Predictive Analytics in decision making, types of Predictive Modeling, Agent Modeling, Case Based Reasoning and Predictive Expert Systems. Text mining, Social Network Analytics, Heuristics, Swarm algorithms, Hybrid Methods and algorithms. Other relevant topics within the subject domain may also be explored.

MSL893 Financial Technology

1.5 Credits (1.5-0-0)

Pre-requisite(s): MSL302 or MSL708

This course aims to acquaint students with the area of Behavioral Finance. We begin by understanding the classical rational finance and then discuss the deviations from it. We then discuss some of the common biases in humans and how they affect finance and the related aspects. We connect all of these to study the concept of prospect theory. We also introduce some market anomalies and their possible explanations using behavioral finance. To conclude, we develop framework on how we can mitigate these biases as investor and in firms.

MSL894 Social Media & Business Practices

1.5 Credits (1.5-0-0)

Pre-requisite(s): MSL302 or MSL708

This course aims to help students learn about Financial Technology or Fin Tech. We discuss its evolution, interaction with finance, and the major technologies driving it. We study money and payment, digital money and cryptocurrencies, and introduce the underlying Block chain and cryptography technologies. Applications in Investment and trading under the Fintech environment are discussed along with introduction to data protection and privacy, cybersecurity and technological risk. Multiple case studies provide a practical overview into the Fin Tech development in developed and emerging markets. We also discuss the evolving nature of regulation that come with Fintech, including Regtech and wrap up with ideas on how technology could continue to transform the careers and finance in the future.

MSL895 Advance Data Analysis for Management

3 Credits (3-0-0)

Pre-requisite(s): MSL301 & MSL302

Module I: Descriptive vs. Inferential Analysis, Parametric vs. Nonparametric Analysis, Univariate, Bivariate and multivariate analysis, Hypothesis Testing and Estimation

Module II: ANCOVA, MANOVA, Logit Regression, Tobit Regression, Panel Regression.

Module III: Factor Analysis, Cluster Analysis, Discriminant Analysis, Data Envelopment Analysis, Structural Equation Modelling.

MSL896 International Economic Policy

3 Credits (3-0-0)

Pre-requisite(s): MSL301 & MSL302

World trade; The standard trade model; economies of scale and international trade; international factor movements; instruments of trade policy; exchange rates and foreign exchange markets; money, interest rates and exchange rates; price, output and exchange rates; different exchange rate regimes and policy, optimum currency area; Global capital markets; Financial crisis and contagion, Transition economies: crisis and reform.

MSL897 Consultancy Process and Skills

3 Credits (3-0-0)

Pre-requisite(s): MSL301 & MSL302

Module I: Introduction to Consultancy-its evolution, growth & status, Types of Consulting Services, firms and role of consultants, client-consultant relationship. Marketing of Consultancy Services.

Module II: The Consulting Process-Entry, Diagnosis, Action Planning, Implementation and Termination/Closing;

Module III: Methods of selection of consultants, Costs and fee calculation, Preparation of Consultancy proposals and Agreements, Technical Report Writing and Presentation.

MSL898 Consultancy Professional Practice

3 Credits (3-0-0)

Pre-requisite(s): MSL301 & MSL302

Module I: Negotiation Skills, Professional Ethics and Code of Conduct. Managing a Consultancy firm-fundamentals of consulting firm management, consulting firms and IT in consulting firms, management of consulting assignments.

Module II: Consulting in various areas of Management-Consulting in general and strategic management, consulting in financial management, consulting in marketing and distribution management, consulting in production and operation management, consulting in HRM, consulting in IT.

Module III: R&D-Consultancy relationship, Careers and Compensation in Consulting, Training and development of Consultants, Future Challenges and Opportunities in Consultancy.

MSL899 Current and Emerging Issues in Consultancy Management

3 Credits (3-0-0)

Pre-requisite(s): MSL301 & MSL302

Relevant current and Emerging Issues – Open Slot – Content will be decided by faculty.

MST893 Corporate Sector Attachment

2 Credits (0-0-4)

The students would undertake corporate training in the industry. This course would evaluate the projects and experiences of the interns of the full time MBA programme. A report would need to be submitted in the prescribed format with due feedback from the company where the work was undertaken. Scope, achievement of objectives and quality of deliverable would be evaluated.

MSC894 Seminar

3 Credits (0-0-6)

Research of the industry in which they are currently working/related.

MST894 Social Sector Attachment

1 Credit (0-0-2)

The student shall spend a minimum of 28 hours with a non-profit organization. The organization should be registered with government. The student proposes nature of work to be carried out and get in approved by the organization. Each student is given a faculty mentor for effective execution of the proposed work. After the engagement period, both the organization and the faculty certifies the work.

Department of Materials Science and Engineering

MLL100 Introduction to Materials Science and Engineering

4 Credits (3-0-2)

Structure of Solids: atomic and inter-atomic bonding, crystal structure and imperfection in solids. Properties of Materials: Mechanical, chemical, electrical and magnetic properties of metals, ceramics and polymers. Processing of Materials: Thermodynamics basics, Phase diagrams and phase transformation of metallic systems, fabrication and processing of metals, polymers and ceramics. Performance of materials: Creep, fatigue, failure and corrosion of metals, ceramics (including cement and concrete), polymers, and composites (including fiber reinforced structure, sandwich panels, and wood). Selection of Material: selection of materials for various applications, materials selection charges, CSE software, Example case studies such as materials for large astronomical telescopes, springs, flywheels, safe pressure vessels and reactors. Laboratory: The behavior of different type of materials (e.g. metals, ceramics, composites, polymers) will be studied through carefully designed experiments. The fundamentals of structure and properties of various materials will be communicated through hands on experiments and model demonstration.

MLL103 Introduction to the Thermodynamics of Materials

4 Credits (3-1-0)

Concept of state and equilibrium. Heat, work, temperature. System and surrounding. Extensive and Intensive properties. Zeroth law. Ideal gas, reversible and irreversible processes. Adiabatic process. First law of thermodynamics and internal energy. Constant pressure process and enthalpy. Applications of the first law. Specific heat at constant temperature and pressure. Thermochemistry.

Second law of thermodynamics: Kelvin-Planck and Clausius statements and their equivalence. Entropy. Carnot cycle. Combined statement of first and second laws. Statistical interpretation of entropy, entropy and disorder. Microstate and macrostate. Configurational and thermal entropy.

Auxiliary functions: Helmholtz free energy, Gibbs free energy, Chemical potential. Various thermodynamic partial derivatives and their relations. Maxwell's relations, Gibbs-Helmholtz equations. Third law of thermodynamics.

Phase equilibria in one-component systems: variation of Gibbs free energy with temperature and pressure, Clausius-Clapeyron equation, P-T diagram.

Thermodynamics of solutions: Raoult's and Henry's Law, activity of a component. Ideal solution. Gibbs-Duhem equation and its application.

Non-ideal solutions: Regular solutions. Sievert's Law, activity and alternative standard states, dilute solutions and interaction parameters. Equilibrium constant, Reaction equilibria for (a) homogeneous reactions consisting of gas mixtures, (b) heterogeneous reactions consisting of condensed phases and gas mixtures, Ellingham Diagram.

MLL105 Structure of Materials

4 Credits (3-0-2)

Structure at different length scales, correlation between structure and properties of materials (through examples), Atomic structure of solids: bonding. Bonding forces and energies, primary bonding and secondary bonding, band structure. Crystal structure. Types of solids (monocrystals, polycrystals, amorphous materials), generation of orderly patterns by symmetry operations, concept of lattice, concept of unit cell, Bravais lattices, crystal systems, point groups, space groups, Pearson and Strukturbericht notations, crystallographic positions, planes and directions, atomic hard sphere models, close packing, voids, allotropy and polymorphism, crystal structure determination. Defects in solids: point defects, dislocations, interfaces, and volume defects. Introduction to microstructures. Theory of alloying: substitutional solid solutions, Hume-Rothery rules, interstitial solid solutions, ordering in solids.

MLL181 Materials and Sustainable Developments

3 Credits (3-0-0)

Overview of Sustainability, Design for Sustainability, Sustainable

Technology Development, Life Cycle Assessment, Materials Extraction and Resource Implications, Environmental Impacts During Processing, Waste Management and Materials Recycling, Green Chemistry, Environmental Protection, Environmentally Friendly Materials, Materials for Green and Renewable Energy, Renewable Energy Policy, Environmental Justice, legislation, Various Policies for Sustainability, etc.

MLL202 Characterization of Materials-I

4.5 Credits (3-0-3)

Studies by optical microscope: Image formation, resolving power, numerical aperture, empty magnification, depth of focus, components of microscopes, important lens defects and their correction, bright field and dark field images, principles of phase contrast, interference and polarized light microscopy, image processing and sample preparation techniques.

X-Ray diffraction and their applications: Production and properties of X-ray, absorption of X-rays and filters, X-ray - diffraction directions, diffraction methods. X-ray diffraction intensities, factors affecting intensity, 'structure factor' calculations for simple, body centered, and face centered, diamond cubic and hexagonal crystal structures. Working principles of diffractometer, counters and cameras. Indexing of XRD patterns. Precise lattice parameter determination, compositional analysis by X-ray diffraction, determination of particle size and micro/macro strains, polymer crystallinity.

Scanning electron microscope: Interaction of electrons with matter, modes of operation, sample preparation, image formation of plane and fractured surfaces, morphological and compositional analysis.

Spectroscopic Techniques: Fundamentals of spectroscopic analysis using FT-IR, UV-Visible and X-ray Photon Spectroscopy.

Thermal Analysis Techniques: Fundamental basis of DSC/DTA/TGA and dilatometry.

MLL204 Phase Equilibria and Transformation

3 Credits (2-1-0)

Equilibrium, Phase rule, Single and multicomponent system: Gibbs Free energy as a function of temperature, ideal solutions, chemical potential, regular solutions, activity; Equilibrium in heterogeneous systems: Binary phase diagrams, systems with miscibility gap, ordered alloys, the effect of temperature on solid solubility, the kinetics of phase transformations; TTT diagram of steel, shape memory diagram, phase diagram of ceramic system (Al₂O₃-SiO₂) and MgO-Al₂O₃. Ternary phase diagram, Diffusion: Atomistic mechanism, interstitial diffusions, steady state and non-steady state (Fick's Law), spinodal decomposition, crystal interfaces and microstructure, interfacial energy, solid/vapor interfaces; Solidification: nucleation and growth in pure metals.

MLL206 Introduction to Polymeric Materials

4 Credits (3-0-2)

Different classes of polymers and their nomenclature, molecular weights, their significance and methods for their determination; glass transition temperature, crystallinity, and morphology; condensation and addition polymerization, kinetics and reactivity ratios; polymerization methods-bulk, solution, suspension and emulsion, inorganic polymers, surface functionalization, additives and reinforcements for polymers, concept of blends, alloys and composites, general polymer processing techniques, commodity plastics and engineering polymers, recycling and reuse.

MLL213 Materials Modelling

3 Credits (3-0-0)

Data analysis and data acquisition, Finite element difference and finite element methods, Applications to structure, thermodynamics and phase transformations, Monte-carlo simulations and integration: Random walk model, Metropolis algorithm, Examples of the Monte Carlo Method in Materials Science, Molecular Dynamics: State Variables or Dependent Variables, Equations of State, Models of Interatomic Potentials, Equations of Motion and integration of the Equations of Motion, Linear and Non-linear regression, Introduction to Machine learning.

MLL252 Mathematical Methods in Materials Engineering

3 Credits (2-1-0)

Vector Calculus: Gradient, Divergence and Curl, Physical interpretation, Laplacian.**Calculus of variations:** Euler equations, Lagrangian multipliers, Variations with constraints.**Tensor analysis:** Contraction, Quotient rule, Pseudotensors, Dual tensors, Tensor properties of crystals: Equilibrium and transport properties.**Group theory:** Applications to crystal symmetry and point groups, Representation theory, Character tables.**Fourier Analysis:** Fourier Series, Approximation by Trigonometric Polynomials, Fourier Cosine and Sine Transforms, Fourier Transform. Discrete and Fast Fourier Transforms.**Partial Differential Equations (PDEs):** Basic Concepts of PDEs, solution by separating Variables, Heat equation and application to heat Flow from a body in Space, Solution by Fourier Series, Steady Two-Dimensional Heat Problems.**MLL253 Electronic, Optical and Magnetic Properties of Materials**

3 Credits (3-0-0)

Electronic Properties: Classical conductivity, Quantum description of conductivity, Effect of alloying in metals, Intrinsic & extrinsic semiconductor properties, Application of Fermi-Dirac statistics, Fermi level & Hall effect, Two probe and four probe measurements, Conductive polymers, Ionic conductors, Superconductors, Device applications (Diode, Ohmic/Schottky junctions etc.).**Dielectric properties:** Dielectric constant, Maxwell's equations, Complex dielectric constant, frequency dependence, Non-linear dielectrics, Chemical synthesis routes.**Optical properties:** Beer-Lambert's law, Transmittance, reflectivity & conductivity, Classical & quantum approach to optical properties, Phonons, Spectroscopy, luminescence, fluorescence, Optical devices (LASERS, LEDs).**Magnetic Properties:** Types of magnetism (Ferro-, para-, ferri-, dia- and antiferro-), Susceptibility, Curie temperature, Neel's temperature, Domain structure and magnet design; Synthesis of magnetic and superconducting materials.**MLL271 Mechanical Behavior of Materials**

4 Credits (3-1-0)

Elasticity: Elastic Constants And Atomistic Origin; State Of Stress, Mohr Circle; Stress And Strain Tensor, Isotropic Versus Non-isotropic Materials; Non-linear Elasticity (Eg., Polymers) And Viscoelasticity. Plasticity: Yield Criteria & Work Hardening, Stress-strain Curve; Single Crystal Slip & Twins; Theoretical Shear Strength. Defects In Solids; Dislocations: Burgers Vectors, Slip Systems; Dislocation Motion: Stress Field Of Dislocation; Forces On Dislocations, Dislocation Multiplication And Interaction With Other Dislocations. Strengthening Mechanisms. Fracture And Fatigue; Fracture And Fatigue Mechanisms; Linear Elastic Fracture Mechanics, Griffiths Criteria, Fracture Toughness; Fatigue Testing, Fatigue Crack Propagation, Creep And Creep Mechanisms, Correlation Between Properties And Performance, Deformation Mechanism Maps.

MLS302 Research Practice for Beginners

1 Credits (0-0-2)

Problem formulation: which topic or field is being examined and what are its component issues?**Literature search:** finding materials relevant to the subject being explored.**Data evaluation:** determining which literature makes a significant contribution to the understanding of the topic.**Analysis and interpretation:** discussing the findings and conclusions of pertinent literature.**MLP311 Functional Materials Laboratory**

1.5 Credits (0-0-3)

This course is an extension of MLL 211. It is expected that enrolled students would have successfully completed the credits of this course. The prior knowledge of content of this course would be mandatory.

MLL341 Materials Processing

3 Credits (2-0-2)

Introduction to primary processing of materials: Solidification in metals (casting process and defects), powder processing for metals and ceramics (sintering techniques and compaction) and Moulding processes for polymers (Compounding and injection, blow and compression processes). Microstructure processing; Specific processing or case studies: Ironmaking, steelmaking; non-ferrous metals; Thermoset and thermoplastic polymers; Alumina and Zirconia processing.**Introduction to secondary processing in materials:** Machining and Mechanical working (Rolling, Forging, extrusion, sheet metal forming etc.); Heat treatment; Joining (Soldering, Brazing, Adhesives, Fasteners and Welding) processes.**Introduction to surface finishing processes:** Electrolytic-polishing and plating, and spray coating (Plasma spray coating processes), paint finish; surface hardening treatments.**Introduction to Special processes:** Thin-film and semiconductor processing: PVD and CVD processes, single crystal growth (vapour phase transport, Czochralski, Bridgman); Rapid prototyping processes (additive manufacturing including typical 3D printing techniques like extrusion melting, selective laser melting/sintering, e-beam melting and droplet ejection).**MLL342 Materials Selection and Design**

3 Credits (3-0-0)

Historical evolution of engineering materials, evolution of materials in products, Engineering materials and their properties: families of engineering materials, materials information for design, materials properties, Materials property chart: exploring materials properties, materials property charts e.g. the modulus- density chart, the strength-density chart, the fracture toughness-modulus chart, thermal conductivity-electrical resistivity chart, Materials selection-the basics: the selection strategy, materials indices, the selection procedure, Multiple constraints and conflicting objectives: selection with multiple constraints, conflicting objectives, Selection of materials and shape: shape factors, limits to shape efficiency, exploring the materials shape combinations, materials indices that include shape, architected materials, Processes and process selection: classification of processes: shaping, joining and finishing, processing for properties, process selection, ranking process cost, Designing hybrid materials: holes in materials property space, composites, sandwich structures, cellular structures, segmented structures, case studies

MLL351 Iron and Steel Making

2 Credits (2-0-0)

Introduction to production of Iron and Steel: Early history of iron and steel, evolution of iron and steel making technology, iron and steel making in India, overview of blast furnace iron making and modern steel making, sponge iron making, smelting reduction processes, general physiochemical fundamentals, present status of world steel industry, general layout of integrated steel plants, raw materials for steel making, steel making refractories.

Classification of furnaces; different kinds of furnaces; heat balance, energy conservation and energy audit; parts, construction and design aspects of blast furnace, ancillary equipment; blast furnace instrumentation; Blast furnace reactions; Gruner's theorem, carbon deposition, the partitioning of solute elements between the Iron and the slag; reactions in blast furnace; blast furnace slags; mass balance and heat balance.

Blast furnace (B/F) operations: B/F irregularities and remedial measures, B/F refractories and causes of failure, modern trends in (B/F) technology overview of direct reduction processes, electric smelting; production of DRI (HBI/Sponge iron).**Alternate Iron Making Processes:** Sponge iron making -coal-based and gas-based, smelting reduction processes-fundamentals, categorisation, salient features of Corex, Hismelt, Finex, Fastmet, ITmk3 processes, Mini-blast furnace.Review of traditional steel making; physical chemistry and thermodynamics; air/O₂ impurity interaction, slag metal interaction, role of slags in refining, continuous casting; foaming slag; removal of S and P; de-oxidizers, alloying; Open hearth F/C and operation;

Bessemer converters; bottom blown and top blown processes; slag practices and sequencing; LD, VD, AOD, and VOD; Ladle metallurgy; electric arc furnace and DRI usage; energy, environmental and quality considerations.

MLP352 Mechanical Behavior of Materials Laboratory 1.5 Credits (0-0-3)

Pre-requisite(s): MLL251

Tensile/compression/Flexural testing, Viscoelasticity, Strain Ageing and Yield Point Phenomenon, Hardness testing, Impact testing, Fatigue testing, Creep testing, Effect of temperature on mechanical properties, Dislocation observation by etch pit technique, Strengthening mechanism demonstration (grain size or work hardening or precipitation strengthening), Plastic anisotropy, Dynamic mechanical behaviour.

MLL353 Metal Casting Technology

2 Credits (2-0-0)

Introduction to casting and foundry industry; basic principles of casting processes; sequence in foundry operations; patterns; moulding practice; ingredients of moulding sand and core sand, sand testing; different moulding processes.

Types of furnaces used in foundry; furnaces for melting; melting practice for steel, cast iron, aluminium alloys, copper alloys and magnesium alloys; safety considerations; fluxing, degassing and inoculation.

Sand casting, permanent mould casting, die casting, centrifugal casting, plaster mould casting, investment casting, continuous casting, squeeze casting, full mould process, strip casting.

Overview of pouring and solidification, concept of shrinkage, Chvorinov's rule, chilling; gating systems, functions of riser, types of riser, bottom pouring and top pouring, yield calculations, visualization of mould filling (modeling), methoding.

Concepts of solidification; directional solidification, role of chilling; filtration of liquid metals; consumables; details of inoculation and modification – with respect to cast irons and Al-Si system; casting defects; soundness of casting and its assessment.

MLL362 Principles of Metal Extraction

4 Credits (3-1-0)

Materials and heat balance, Application of Thermodynamics, Mineral beneficiation processes. Iron making. Steel making. Al production. Hydrometallurgy.

MLP362 Metallography Lab

2 Credits (0-0-4)

Sample preparation procedure for metallographic observation: Sample machining and mounting, Mechanical polishing, chemical polishing, electrolytic polishing, Etchants selection and Etching procedure (macro etching, electrolytic etching, chemical etching); Study of metallurgical microscope.

Microstructure observation in optical microscope: Microstructure of various ferrous (for example: cast iron, iron, carbon steels, stainless steels, over heated and banded structures etc.,) and non-ferrous (Cu-, Al-, Pb-, Mg-, Ti- and Ni- alloys) metal grades.

Microstructure interpretation and analysis: Grain size measurements (line-intercept-, ASTM grain size-, digital images based- methods), particle or precipitate size, fraction and distribution analysis. In situ metallography practice.

MLL364 Glass and Ceramics

2 Credits (2-0-0)

Part-1 Glass: Definition of glass, principles of glass formation (Zachariasen's rule), determination of glass forming ability and stability, glass melting, raw materials, compositional nomenclature, batch calculation, immiscibility of glass forming system, structure of glasses, network connectivity, dimensionality, bond angle distribution, viscosity of glass forming melts, polymer and metallic glass, density and thermal expansion, glass ceramics.

Part-2 Ceramics: Ceramics synthesis: Solid State reaction, coprecipitation, sol-gel, precursor, microemulsion, solvothermal/

hydrothermal, ion-exchange, mechano-chemical synthesis; science of colloidal processing, powder consolidation and forming of ceramics, sintering, refractory material (case studies: alumino silicate, spinel, ZrO₂, Si₃N₄, SIALON etc.), white wares, surface and coating.

MLP372 Mechanical Behavior of Materials Laboratory 1.5 Credits (0-0-3)

Tensile/compression/Flexural testing, Viscoelasticity, Strain Ageing and Yield Point Phenomenon, Hardness testing, Impact testing, Fatigue testing, Creep testing, Effect of temperature on mechanical properties, Dislocation observation by etch pit technique, Strengthening mechanism demonstration (grain size or work hardening or precipitation strengthening), Plastic anisotropy, Dynamic mechanical behaviour.

MLL402 Corrosion and Degradation of Materials

4 Credits (3-0-2)

Introduction to corrosion and degradation of materials. Electrochemical thermodynamics and kinetics of corrosion. Passivity. Corrosion related failures and types of corrosion (Uniform, Galvanic, Crevice corrosion, Pitting, Intergranular, Dealloying, Erosion, Cavitation, Fretting, Corrosion cracking, Corrosion fatigue, and Microbiological corrosion). Elevated temperature corrosion (oxidation, creep, thermal fatigue, metallurgical instabilities). Thermodynamics and kinetics of oxidation. Environmental degradation of engineering materials including glass, polymers, ceramics and composites. Corrosion prevention (cathodic protection, coatings and inhibitors).

MLL403 Characterization of Materials-II

3 Credits (3-0-0)

Transmission Electron Microscope (TEM): Working principle of TEM. Image formation, resolving power, magnification, depth of focus, important lens defects and their correction. Selected area diffraction patterns, reciprocal lattice and Ewald sphere construction, sample preparation, compositional analysis. Electron energy loss spectroscopy (EELS) in TEM.

Auger electron spectroscopy (AES): Principle of AES. The mechanism of the Auger process. Source of electrons.

X-ray photoelectron spectroscopy (XPS): Physical basis of XPS method and the experimental technique. Basic laws of XPS spectra. X-Ray semi-quantitative analysis. Practical application of the method XPS, Comparative characteristics of AES and XPS.

Secondary ion mass spectrometry (SIMS): Secondary ion emission. Qualitative and quantitative analysis, Bulk doping, Practical application of SIMS.

MLL412 Engineering Biomaterials

2 Credits (2-0-0)

Definition of biomaterials (history & background), Classification of biomaterials (based on response, materials & applications), Biocompatible materials, Biocompatibility, Cytotoxicity and Testing (In vitro/ In vivo), Structure-property correlation, Processing of biocompatible materials including various fabrication techniques.

MLL413 Physical Chemistry of Polymers

3 Credits (3-0-0)

The course content includes polymer molecules, their conformations, crystalline and two phase structures and their effects on various thermo- physical properties such as melting, glass transition and crystallization kinetics.

MLL414 Polymer and Elastomer Technology

3 Credits (3-0-0)

Commodity plastics; additives for plastics; industrial process to manufacture, properties and applications of major thermoplastic and thermosets. Natural and synthetic elastomers, additives for rubbers, compounding and vulcanization.

MLL415 Rheology and Processing of Polymers

4 Credits (3-0-2)

Course covers Newtonian and non-Newtonian flow, simple shear flow,

elongational flow, viscoelasticity, Rheometers, molecular models, classification of polymer processing operations, extrusion, molding based processes, compounding and mixing, thermoforming and other processing methods.

MLL416 Polymer Matrix Composites

2 Credits (2-0-0)

The course will cover definition and classification of composites, miscibility, nature of interface, nature of polymer matrices, reinforcements, basic theoretical models to predict mechanical properties and the role of distribution, dispersion etc. on the performance properties of polymer based composites.

MLP441 Materials Selection and Design Lab

1.5 Credits (0-0-3)

This course is an extension of MLL 372. It is expected that enrolled students would have successfully completed the credits of this course. The prior knowledge of content of this course would be mandatory.

MLL451 Welding Metallurgy

3 Credits (2-0-2)

Fundamentals: Fusion and Solid-State Welding, Energy Sources, Arc Characteristics, Metal Transfer, Physical Properties of Metals and Shielding Gases. Heat Flow in Welding, Quantitative Calculation of Heat Transfer, HAZ width, Residual Stress and Distortion.

ARC Welding Processes: Power Sources, Principles of Operation, Volt-Ampere Characteristics. Fusion Welding Processes: SMAW, GTAW, GMAW, FCAW, SAW, Stud AW: Fundamentals, Equipment, and filler metal classifications, Materials weldability, Applications, Welding Variables, Weld Quality, Process Variations; Other Welding Processes.

Welding Metallurgy: Phase transformations- weld CCT diagrams - carbon equivalent-preheating and post heating; Welding of steels - use of Schaffler and DeLong diagrams, Cast irons & Non-ferrous alloys: Metallurgical Difficulties, Process selection, Filler metal selection, safe welding procedures.

Tests, Qualifications and Safety: Overview of Weld Discontinuities, Weldability, Mechanical tests. WPS, PQR and WPQ. Safety in Welding.

MLL452 Powder Metallurgy

3 Credits (3-0-0)

Introduction – Historical background, important steps in powder metallurgy (P/M) process – Advantage and Limitations and Applications.

Methods – Production of ceramic powders, automation, rapid solidification technique. Characteristics: sampling – chemical composition, particle shape and size analysis, Surface area, packing and flow characteristics, Porosity and density, compressibility, Strength properties. Blending and mixing of metal powders; Compaction of powders, pressure less and pressure compaction techniques, Hot temperature compaction – Uni-axial hot pressing, Hot extrusion, Spark sintering, Hot isostatic pressing, Injection moulding – Sintering: Types, Theory, process variables, Effects, atmospheres, metallographic technique for sintered products.

Post sintering operations; Products: Porous parts, sintered carbides, cermets, dispersion strengthened materials, electrical applications, sintered friction materials.

Atomization, Mechanical alloying, Metal Injection moulding, Microwave sintering and self propagating high temperature synthesis.

MLL453 Heat treatment and Surface Engineering

3 Credits (2-0-2)

Introduction to heat treatment procedure, different schemes; Influence of them on the metals/alloys microstructure; Microstructural analysis.

Iron-carbon equilibrium diagram: Transformations on heating and cooling. Influence of alloying elements, TTT & CCT diagrams. General principles for steels. Heat treatment equipment's.

Heat treatment processes, hardenability studies, Jominy end quench test, austempering and martempering. thermo mechanical treatments. Precipitation hardening.

Surface modification technique, Heat treatment of specific alloys: HSLA steels, high speed steels, maraging steels, tool steels and die steels. heat treatment of gray irons, white irons (malleabilising) and S.G.Irons. austempering of S.G.iron. heat treatment of various non-ferrous alloys.

Defects: Defects in heat treated parts, causes and remedy design for heat treatment.

Softwares: Introduction to heat treatment softwares.

MLL701 Structure and Characterization of Materials

3 Credits (3-0-0)

Basic concept of crystallography, crystal structure, stereographic projection, diffraction analysis of crystal structure: X-ray, neutron and electron diffraction, texture analysis, selected area diffraction in electron microscope, micro-analysis in electron microscopy, scanning probe microscopy and related techniques, Chemical characterization will include Rutherford back scattering, Auger, X-ray photoemission, Energy dispersive, Wavelength dispersive, and Raman spectroscopes. Quantitative and tomographic analysis of microstructures (3D diffraction and imaging techniques). Mass spectrometry and NMR spectrometry.

MLL702 Thermodynamics of Materials

3 Credits (3-0-0)

Laws of thermodynamics: Thermodynamic systems and variables, Zeroth, 1st, 2nd and 3rd laws. Combined statement for 1st and 2nd laws; Equilibrium in thermodynamic systems: Free energy and criteria for equilibrium; Statistical interpretation of entropy; Unary heterogeneous systems: Phase equilibrium in one component system, Chemical potential, Clausius-Clayperon equation, Unary phase diagram; Thermodynamics of solutions: Partial molar quantities, Fugacity and activity, The behavior of dilute solutions, ideal, non-ideal and regular solutions; Binary heterogeneous systems: Gibbs phase rule and binary phase diagrams, Free energy composition diagrams, Common tangent construction, Phase equilibrium calculations; Introduction to ternary phase diagrams; Thermodynamics of electrochemical systems, cell reactions and EMF, Formation and concentrations cells; Thermodynamics of interfaces: Surface tension and surface energy, Surface excess properties, Effect of surfaces on phase diagrams; Equilibrium shape of a crystal: Gibbs-Wulff construction; Adsorption: The Gibbs adsorption equation.

MLL703 Mathematical and Computational Methods in Materials

3 Credits (3-0-0)

Review of linear algebra: Vectors, Matrices, Functions, Coordinate transformation (linear and orthogonal), Eigen values and Eigen vectors; Eigenvalue Problems: Matrix and diagonalization; Tensors and its applications in materials science (elastic anisotropy etc.); Vector Calculus for different geometries – Linear and planes, directional derivative, gradients and integral theorems; Partial Differentiation – properties and solution techniques; Integration: Single, multiple, line and change of variables; Ordinary Differential Equations: Analytical and Numerical Solution methods of ODEs; Data Analysis: Probability and statistics - Curve fitting; Computing Probability, smoothening and reconciliation of data, concept and parameters of distribution, regression analysis (linear and nonlinear), Error estimation and analysis, confidence intervals, hypothesis testing; Numerical Techniques: Roots of equation, solution of Linear and Nonlinear systems of equations (Bisection, Newton Raphson), Interpolation and extrapolation.

MLP704 Materials Processing and Characterization Lab

4 Credits (1-1-4)

Materials processing routes: chemical synthesis, powder compaction, Heat treatment – annealing, quenching etc.; Light Microscopy: polishing and microstructure; X-ray diffraction and texture; Mechanical, Electrical and Chemical characterization of materials; Thermal analysis and Spectroscopy of materials; Electron microscopy (SEM, TEM etc.); Micro- and nano- scale response of materials: Instrumented microindenter, Nano-indentation response etc.; Atomic force microscopy; Wear and Fatigue in materials; Creep at nano and bulk levels of materials; Dynamic characterization of materials.

MLL711 Mechanical Behavior of Materials*3 Credits (3-0-0)*

Various types of material deformations and measurement methods. Elastic properties of crystalline materials and its origin. Continuum plasticity: stress vs. strain relationships, Yield criteria; Defects in crystals: point, line and surface; Slip and twin as a micromechanisms of plastic deformation, five independent slip systems. Dislocations as micromechanism of slip. Geometry of dislocations, dislocation motion, source of dislocation and dislocation interactions; Mechanics of dislocations, single and polycrystal deformation. Crystallographic texture; Strengthening mechanisms in crystals: work hardening, grain size hardening, solid solution hardening and precipitation hardening; Fracture modes, fracture mechanics, mechanisms of toughening, microstructural aspects of fracture toughness, fracture testing; Creep and Fatigue of engineering materials; Nanomechanical behavior of materials (nanoindentation, nanoscale wear, in-situ electron microscopy (SEM/TEM). Correlation of mechanical behavior at different length scales.

MLL712/APL753 Materials Design and Selection*3 Credits (3-0-0)*

Historical evolution of engineering materials, evolution of materials in products, Engineering materials and their properties: families of engineering materials, materials information for design, materials properties, Materials property chart: exploring materials properties, materials property charts e.g. the modulus- density chart, the strength-density chart, the fracture toughness-modulus chart, thermal conductivity-electrical resistivity chart, Materials selection-the basics: the selection strategy, materials indices, the selection procedure, Multiple constraints and conflicting objectives: selection with multiple constraints, conflicting objectives, Selection of materials and shape: shape factors, limits to shape efficiency, exploring the materials shape combinations, materials indices that include shape, architected materials, Processes and process selection: classification of processes: shaping, joining and finishing, processing for properties, process selection, ranking process cost, Designing hybrid materials: holes in materials property space, composites, sandwich structures, cellular structures, segmented structures, case studies.

MLL713 Phase Transformations*3 Credits (3-0-0)*

Introduction and classification of phase transformation. Diffusion in Solid: Fick's 1st and 2nd laws, The Kirkendall Effect, Darken's analysis, various diffusion mechanisms. Thermodynamics of Transformation: Free energy of solid solutions, order of transformation, driving force for first order transformation with and without composition change, Second Order transformation, Spinodal decomposition. Nucleation kinetics: Homogeneous and heterogeneous nucleation, homogeneous nucleation with composition change, Heterogeneous nucleation, Strain energy effects. Growth Kinetics: Diffusion-controlled and Interface-controlled growth. Overall transformation kinetics, Johnson-Mehl-Avrami model. Particle coarsening. Recovery, Recrystallization and Grain Growth. Diffusionless transformation: Martensitic transformation. Solidification.

MLL714 Fracture Mechanics*3 Credits (3-0-0)*

Linear elastic fracture mechanics (LEFM) and Elastic plastic fracture mechanics (EPFM). Theoretical cohesive strength. Energy based approach to fracture. Griffiths crack theory. Energy release rate: compliance and strain energy approach. Critical energy release rate and toughness. Stress field around a crack: Modes I, II and III. Plane strain and plane stress. Effect of plate thickness. Stress intensity factor. Critical stress intensity factor and fracture toughness. Plastic deformation near the crack tip. Approximate plastic zone size based on von-Mises and Tresca yield criteria. Irwin and Dugdale approaches. Effective crack size. J-Integral: definition and path independence. Equivalence of J, G and K. Crack-tip opening displacement. Fracture toughness testing. Ductile-brittle transition, impact energy fracture toughness correlation. Cyclic stress and strain fatigue. Fatigue crack

propagation, analysis of engineering failures. Microstructural aspects of fracture toughness. Environmental assisted cracking. Mixed mode crack initiation and growth.

MLL715 Advanced Engineering Materials*3 Credits (3-0-0)*

Introduction to various engineering materials (high strength steels, light metals and alloys (magnesium and its alloys, aluminum and its alloys and titanium and its alloys etc.), composites, smart materials, porous materials etc.) and their property profiles with their relation to basic structure; structure and properties of steels: high- and ultra-high strength steels, TWIP steels, TRIP steels, Dualphase steels, Martensitic steels, Bainitic steels etc.; structure and properties of light metals and alloys: Aluminum and its alloys (Al-Li, Al-Si, Al-Mg-Si etc.), Magnesium and its alloys (Pure Mg and other conventional Mg alloys), Titanium and its alloys (pure Ti, α , $\alpha + \beta$ and β alloys, Transformation induced plasticity Ti alloys, etc.); Introduction, structure and properties to composite materials (metal-matrix, particulate, laminated and fibre reinforced etc.); structure and properties of: hybrid materials, porous materials (metal foams, lattice materials etc.), smart materials (shape memory alloys etc.), auxetic materials; Case studies of materials applications in automotive, aerospace, power generation sectors etc.

MLL716/APL767 Engineering Failure Analysis and Prevention*3 Credits (3-0-0)*

Common causes of failure, principles of failure analysis, fracture mechanics approach to failure problems, techniques of failure analysis, service failure mechanisms, ductile and brittle fracture, fatigue failure, wear failure, hydrogen induced failure, environment induced failures, high temperature failure, faulty heat treatment and design failures, processing failure (forging, casting, machining etc.), failure problems in joints and weldments, case studies for failure analysis of structural components and mechanical system.

MLL717 Engineering and Speciality Polymers*3 Credits (3-0-0)*

Introduction to engineering polymers, applications, processing, thermoplastic engineering plastics, polycarbonates, polyimides, polyphenylene oxide, liquid crystalline polymers, poly(ether ketone), thermosets, speciality polymers, hydrogels, conducting polymers, fluoropolymers.

MLL718 Polymeric Nanomaterials and Nanocomposites*3 Credits (3-0-0)*

Introduction to general aspects of nanostructured materials; Nanocomposites and block copolymers; Interaction parameter, phase behaviour, morphology; Phase diagrams, microphase separation transition; Polymer nanocomposites: Technical challenges; Understanding of interfacial dynamics using LJ Potential and many body problems approach; Nanoreinforcements eg. Nanoclay, POSS, Carbon nanostructures and nanoparticles; Dispersion and percolation; Influence of size, shape and diameter of nanotubes/nanofillers; Functionalisation of nanoparticles and nanoplatelets.

MLL727 Smart Polymeric Materials*3 Credits (3-0-0)*

This course focuses on the syntheses, structures, behaviours of polymers and polymeric materials that are responsive to external stimuli such as temperature, light, electric potential, pH, and ionic strength. The course will contain important new material to understand and characterize molecular and submolecular assemblies that enable the fabrication of switch-driven polymer systems. This introduces the concepts of stimuli-responsiveness, including the fundamental materials properties required for the design. The module also gives an overview of the design, preparation and uses of polymers in the area of smart surfaces, polymer brush, membranes, gated transport, drug release, catalysis, etc. with a focus on the factors governing their physical properties and their structure-property relationships.

MLL730 Diffusion and Kinetics

3 Credits (3-0-0)

Introduction to solid state diffusion, atomistics of diffusion, Fick's first and second laws; thin film solution and tracer diffusion measurements, semi-infinite and infinite diffusion couples - diffusion in a concentration gradient; temperature effects; surface, grain boundary and dislocation pipe diffusion; diffusion in ionic solids, interdiffusion and the Kirkendall effect, measurement of variable diffusion coefficients; thermodynamics vs. Kinetics, elementary and non-elementary reactions, reaction order, activation energy, Arrhenius law, irreversible and reversible reactions, degree of reaction; heterogeneous reactions, kinetics of solid state-gas (fluid) reactions, elementary steps, rate-controlling steps, intrinsic kinetics, chemisorptions, mass transfer in the gas phase and fluid, multicomponent system, Knudsen diffusion, shrinking core model.

MLL732 Porous Materials

3 Credits (3-0-0)

Porous materials: Introduction, processing and structure; Properties of porous materials: Mechanical (in-plane and out-of-plane) and thermal properties; Deformation behaviour of porous solids, Mechanics of honeycombs, foams and fibrous structures; Microstructure design; lattice materials; Characterization and application of porous materials.

MLL734 Texture and Grain Boundary Engineering in Metals and Alloys

3 Credits (3-0-0)

Representation of crystallographic texture (pole figure, orientation distribution, representation in orientation space, volume fraction of texture components), experimental determination of texture using X-Ray diffraction, texture measurements using synchrotron X-Rays, scanning electron microscopy (SEM) and transmission electron microscopy (TEM), texture evolution during metal solidification and during phase transformation, texture during material deformation, texture during material heat treatment (annealing), texture in thin films, influence of texture on material properties, texture control in engineering materials with examples.

MLL736 Tribology and Surface Engineering of Materials

3 Credits (3-0-0)

Surfaces and characterization of surface properties relevant for tribological applications. Mechanics of surfaces in contact. Laws of friction, friction at macroscopic and microscopic length scales. Fundamentals of lubrication: solid and liquid lubrication. Mechanisms and types of wear, strategies for controlling wear. Friction and wear behavior of various classes of materials. Design and selection of materials for tribological applications. Surface modification techniques: surface patterning, surface heat treatment, and surface coatings. Surface and subsurface characterization techniques for tribological applications. Nanomaterials for tribological applications. Recent trends in tribology: Nanotribology, Green tribology, and Biomimetics.

MLL738 Electronic Devices and Characterization

3 Credits (3-0-0)

Overview of semiconductor fundamentals, Semiconductor junctions, Solar cells and LEDs, Metal – Semiconductor junctions: Schottky and Ohmic contacts, Thermionic-emission, Capacitance (C)– Voltage(V) measurements: Doping-Density and majority carrier density profiling, Metal-insulator-semiconductor junctions: MOS capacitor, C-V characteristics; Introduction to MOSFETs; Fin-FET MOSFET, Inverted field effect transistors and characterization of thin films Defects as recombination-generation centres or traps; Measurement of defect density using Capacitance measurements (C-t), Steady and transient measurement Current measurement and Deep Level Transient Spectroscopy (DLTS), Charge Carrier Life time and diffusion length: Generation and Recombination life time, Surface generation and recombination velocity; Photoconductance decay; Photoluminescence Decay.

MLL740 Nanostructures and Nanomaterials

3 Credits (3-0-0)

Overview of Nanostructures and Nanomaterials: Scaling laws, Dimensionality, Hybrid nanomaterials; Effect of size, structure, mechanism, and property on material performance; Synthesis of nanostructures: Bottom up and top down approaches, Thermodynamics of Nanomaterials: Configurational entropy and Gibbs free energy of nanocrystals; Surface reconstruction and reconfiguration.

Nanoelectronics: single electron phenomenon, Quantum transport of electrons, Electrical conductance through a single atom, nanowire, nanotubes; Single electron transistor; Molecular electronics. Photonic properties of nanomaterials: Surface plasmon resonance in metals, bandgap variation in semiconductors, optical tweezers, photonic crystals.

Nanomechanics: Nanomechanical oscillators using beams and atoms, Scanning probe microscopy, Nanomagnetism: Magnetic properties of small magnetic clusters, nanoparticles, Magnetoresistance, Spintronics, Superparamagnetism.

MLL742 Micro and Nano Fabrication in Materials Engineering

3 Credits (3-0-0)

Introduction to microfabrication, crystal growth and defect, diffusion and ion implantation, wafer preparation and specifications, thermal oxidation: Deal-Grove model of oxidation, rapid thermal annealing, pattern transfer by optical and ebeam lithography, photoresist, vacuum science and plasmas, etching, physical (DC and RF sputtering, ebeam evaporation) and chemical vapor deposition, stress measurement in thin film, silicon micromachining.

MLL744 Materials for Additive Manufacturing

3 Credits (3-0-0)

Introduction to various types of additive manufacturing processes for polymers, metals and ceramics, Basics of polymer printing, Basics of powder metal printing of metals, Welding metallurgy applied to electron and laser based powder bed/wire feed, and powder feed methods, Metal powder making, Solidification, Microstructure formation at high cooling rates, Defects in metal 3D printing, Characterization of 3D printed materials, Mechanical behavior of 3D printed metals, Special topics: Ti, Inconel, steel and Al 3D printing, Basics of ceramic 3D printing, Applications of 3D printed materials.

MLL746 Crystals, Symmetry and Tensors

5 Credits (3-2-0)

Geometrical crystallography: Crystals, Lattice and Motif, Miller indices of planes and directions, Reciprocal lattice, Structure and metric matrices.

Symmetry: Point and Space groups, Mathematical groups, Subgroups. Cosets, Lagrange's theorem, Stereographic and matrix representation of Symmetry operations.

Symmetry based classification of crystals, Proper and improper rotation axes, Euler's construction, Glide Planes in 2D and the 17 plane groups, Possible screw axes.

Cartesian tensors: Definition, Rank, Representation quadric, Magnitude of a property in a given direction.

Second-rank tensor properties: Electrical and Thermal conductivity, Thermal expansion coefficient, Piezoelectricity and third rank tensors, Elasticity and fourth rank tensors, Voigt matrix notation for elastic stiffness and compliances.

MLL748 Solid State Diffusion and Kinetics

3 Credits (3-0-0)

Pre-requisite(s): Introductory courses on materials, such as CLL141, MLL100; MLL702, CLL732, CLL252, MLL713, or some equivalent courses dealing with thermodynamics of solids.

Thermodynamic stability diagrams; chemical potential gradient; Gibbs-Duhem equation; steady-state and non-steady states; Fick's laws of

diffusion; Fick's second law for thin-film and homogenization; random walk model; tracer method; jump frequency and correlation factor; effect of orientation and phase transition on diffusion; point defects in crystalline materials; atomic mechanism of diffusion in stoichiometric and non-stoichiometric oxides, ionic solids and intermetallics; Kirkendall effect; types of diffusion coefficients; vacancy wind effect; analytical diffusion models; time-dependent growth laws; interface and diffusion-controlled growth; microstructural evolution of the interfacial reaction zones in bulks, thin films and nanomaterials; physicochemical approach; diffusion in multicomponent systems; phase diagram determination by diffusion couple method; short-circuit diffusion; temperature-, purity- and strain-effects on diffusion; Fisher model; kinetic regimes of grain boundary diffusion; grain boundary segregation; capillarity- and stress-driven diffusion; alloying effect on interfacial reactions; thermodynamic-kinetic approach in advanced functional materials.

MLL750 Imperfections in Materials and Applications

3 Credits (3-0-0)

Pre-requisite(s): MLL100 or some equivalent basic course in materials engineering or MLL101, MLL202, APL108, APL104 and MLL251 (for UG programme), CLL732, CML681, CML729, ELL211, PYL114 or some equivalent courses on crystal structures and thermodynamics.

Thermodynamics of point defects (vacancies and interstitials) in metals and ceramics, defect chemistry, diffusion, electronic properties and applications, geometrical aspects of dislocations, Volterra and atomistic models, stress fields and energy of dislocations, forces on dislocations, dislocation motion and slip, stacking faults and APBs, dislocations in FCC and BCC metals, Strengthening of alloys via dislocations and its applications, thermodynamics of interfaces, Gibbs-Thompson effect, segregation, anisotropy of surface energy, equilibrium shape of crystals, geometry of grain boundaries, high and low angle boundaries, special and general boundaries, effect of grain boundary character on properties.

MLL752 Creep and Superplasticity of Materials

3 Credits (3-0-0)

Pre-requisite(s): MLL101, MLL202, MLL251, PYL114 or some equivalent course in crystallography, APL104/APL105, APL108 is preferred for students from other departments, PYL701 or some introductory course in materials engineering for PG students.

Phenomenology of creep, Microstructural considerations in metals, alloys, ceramics and composites, Creep mechanisms, Deformation mechanism maps, Phenomenology of superplasticity in metallic alloys, ceramics and nanophase materials, Commercial applications and considerations, Cavitation failure at elevated temperatures by the nucleation, growth and interlinkage of cavities. Sintering mechanisms.

MLL760 Materials Simulation Methods using High Performance Computing

3 Credits (2-0-2)

Pre-requisite(s): UG students: MLL213 (Materials Modelling) or MLL252 (Mathematical Methods in Materials Engineering)

Overlaps with: MLL213, CML801, CVL869, CLL774, CML662, APL736, COL730, COL380

Overview of length and time scales in materials modeling and high performance computing in materials. Molecular simulation methods: Interatomic potentials: potential energy surface, Molecular Dynamic (MD) basics and algorithm. Enhanced sampling methods. Free energy landscapes of materials, collective coordinates, phase diagrams, Replica Exchange Molecular Dynamics, Umbrella Sampling, metadynamics, Thermodynamic Integration, An overview of Mesoscale methods: Brownian Dynamics, Dissipative Particle Dynamics. High performance computing (HPC) in materials simulations: Introduction to HPC architecture and organization: memory hierarchy, shared and distributed memory architectures, multiprocessor architecture, Accelerators (GPU), Performance prediction and evaluation, running

simulations in HPC environment, cluster level load balancing, Parallelization in popular software like LAMMPS and GROMACS: domain/spatial decomposition, distribution of nonbonded interaction, dynamic load balancing, multiprocessor communication. Hands-on lab: Application in different materials systems: conformational transitions in polymers, Simulations of nanomaterials, biomaterials, modeling and simulation of colloidal dispersion, melting of metal cluster. (Basic knowledge of Linux will be useful)

MLN710 Research Seminar

1 Credit (0-0-2)

Each student will be given a topic related to his M.Tech project work in his chosen stream area and asked to do literature study and give a research seminar.

MLV705 Special Topics in Materials

1 Credit (1-0-0)

The contents of this course will be decided by the coordinator in consultation with the experts of the various materials areas or streams (example: electronic materials, nano materials, bio materials etc.).

PTV700 Special Lectures in Polymers

1 Credit (1-0-0)

There will only be special lectures followed by a final assignment or quiz.

PTL701 Polymer Chemistry

3 Credits (3-0-0)

Introduction to polymers, nomenclature, addition, condensation, chain growth and step growth polymerization, kinetics of polymerization, material classes, polymerization techniques: bulk, suspension and emulsion polymerization; cationic, anionic and free radical polymerization; copolymerization, reactivity ratios; atom transfer radical polymerization.

PTL702 Polymer Processing

3 Credits (3-0-0)

Course covers the classification of polymer processing operations, extrusion, molding based processes, compounding and mixing, thermoforming and other processing methods.

PTL703 Polymer Physics

3 Credits (3-0-0)

The course content will include polymer molecules, their conformations, crystalline and two phase structures and their effects on various thermo-physical properties such as melting, glass transition and crystallization kinetics.

PTL704 Polymer Technology

3 Credits (3-0-0)

Polymers of commercial importance; additives for plastics; stabilizers, fillers, plasticizers and extenders, lubricants and flow promoters, flame retardants, blowing agents, colourants, cross-linking agents and biodegradation additives; manufacture, properties and applications of major thermoplastic and thermosetting polymers: polyethylene, polypropylene, poly(vinylene chloride), polystyrene and other styrenics, phenol-formaldehyde, urea-melamine formaldehyde and unsaturated polyester resins.

PTL705 Polymer Characterization

3 Credits (3-0-0)

Molecular weight and molecular dimensions by end-group analysis, osmometry, light scattering, viscometry, gel permeation chromatography, MALDI-TOF, Infra-red, NMR, UV-visible and Raman spectroscopic techniques. Thermal properties by differential scanning calorimetry, differential thermal analysis, thermogravimetry; Microscopy: optical and electron microscopy, X-ray scattering from polymers, small angle light scattering; crystallinity by density measurements.

PTL707 Polymer Engineering and Rheology*3 Credits (3-0-0)*

Course covers Newtonian and non-Newtonian flow, simple shear flow and its significance, normal stresses, simple elongational flow and its significance, viscoelasticity, Rheometers, molecular, theoretical and related models.

PTP709 Polymer Science Laboratory*2 Credits (0-0-4)*

Experiments: identification of polymers; purification of monomers; suspension polymerization of styrene; emulsion polymerization of vinyl acetate and butyl acrylate; bulk and solution polymerization of methyl methacrylate; preparation and testing of epoxy resins; unsaturated polyester resin technology; preparation of nylon 6 and nylon 10 by interfacial polymerization; copolymerization and determination of reactivity ratios; epoxide equivalent; molecular weight determination by viscometry and end-group analysis; atom transfer radical polymerization of styrene; thermal characterization by DSC and TGA; GPC; FTIR and NMR.

PTP710 Polymer Engineering Lab*1 Credit (0-0-2)*

The course comprises of eight regular experiments on various processing equipments and two experiments dealing with rheology of polymer melts.

PTL712 Polymer Blends and Composites*3 Credits (3-0-0)*

The course will cover definition and classification of blends and composites, miscibility, phase behaviour, nature of interface, nature of polymer matrices, reinforcements, basic theoretical models to predict mechanical properties and the role of fibre length, distribution, dispersion etc. on the performance properties of polymer based blends and composites.

PTL713 Polymer Testing and Properties*3 Credits (3-0-0)*

Properties of polymers and their measurements by standard test methods; tensile, flexural and impact properties; hardness, abrasion resistance and long term fracture properties; softening point, heat distortion temperature, thermal expansion coefficient and thermal conductivity; electrical insulation and conductivity; sorption, diffusion and permeation of gases/liquids through polymer membranes; standards used are BIS, BS, ASTM, ISO and DIM; correlation of test with actual performance; statistical quality control in various tests.

PTL714 Biodegradable Polymeric Materials*3 Credits (3-0-0)*

Concept of biodegradation; mechanism of biodegradation; kinetics of biodegradation; methods to evaluate biodegradation; bioplastics, biodegradable polymers and their synthesis; biodegradable polymer blends and composites; technology and processing of biodegradable polymers; applications of biodegradable polymers.

PTL716 Rubber Technology*3 Credits (3-0-0)*

Rubber and elastomers, compounding and vulcanization, mastication, fillers-reinforcing and non-black (loading type). Other compounding ingredients; peptizers, vulcanizing agents, accelerators, accelerator activator, softeners, anti aging additives, miscellaneous additives, colourant, flame retarders, blowing agents, deodorants, abrasive retarders etc. Processing and vulcanization tests, vulcanization theory and technology, natural and synthetic rubbers, styrene butadiene

rubbers, polybutadiene and polyisoprene rubbers, ethylene-propylene rubber, butyl and halobutyl rubber, nitrile and silicone rubber, thermoplastic elastomers, acrylate and fluoro elastomers.

PTL718 Polymer Reaction Engineering*3 Credits (3-0-0)*

Course covers reaction kinetics in condensation and all types of addition polymerisation reactions, prediction of molecular weight for polymerisation in different types of reactors, batch and continuous processes, the effect of mixing on kinetics and MWD, reactor design.

PTL720 Polymer Product and Mould Design*3 Credits (2-0-2)*

Course covers the types of moulds and dies, product and mould design, details of construction and manufacturing methods of tools, dies and moulds.

PTL722 Polymer Degradation and Stabilization*3 Credits (3-0-0)*

Introduction to degradation, thermal and oxidative degradation; radiative, mechanical and chemical degradation; biological degradation; degradation pathways for common polymers; methods to monitor degradation; mechanical degradation, waste management.

PTL724 Polymeric Coatings*3 Credits (3-0-0)*

Introduction and mechanism of adhesion of polymeric coatings on various substrates. Solvent based polymeric coatings. Water based polymeric coatings. UV and EB curable coatings. 100% convertible coatings. Selection criteria of coatings for various substrates. Health, safety hazard and environmental aspects of coatings during manufacturing and applications.

JPD799 Minor Project*3 Credits (0-0-6)*

A project in any area of polymers as decided by the supervisor.

JPS800 Independent Study*3 Credits (0-3-0)*

The course contents are as defined for the program elective courses offered by the Centre.

JPD801 Major Project Part-I*6 Credits (0-0-12)*

A project in any area of polymer science and technology.

JPD802 Major Project Part-II*12 Credits (0-0-24)*

A project in any area of polymer science and technology.

MLD801 M.Tech Project Part I*9 Credits (0-0-18)*

The project/research topic will be decided/allotted by the student's assigned M.Tech project supervisor after successfully completing the core and elective course credit requirements.

MLD802 M.Tech Project Part II*9 Credits (0-0-18)*

The project/research topic will be decided/allotted by the student's assigned M.Tech. project supervisor after successfully completing the core and elective course credit requirements.

Department of Mathematics

MTL100 Calculus

4 Credits (3-1-0)

Review of limit, continuity and differentiability, uniform continuity. Mean value theorems and applications, Taylor's theorem, maxima and minima. Sequences and series, limsup, liminf, convergence of sequences and series of real numbers, absolute and conditional convergence.

Riemann integral, fundamental theorem of integral calculus, applications of definite integrals, improper integrals, beta and gamma functions.

Functions of several variables, limit and continuity, partial derivatives and differentiability, gradient, directional derivatives, chain rule, Taylor's theorem, maxima and minima and the method of Lagrange multipliers.

Double and triple integration, Jacobian and change of variables formula. Parameterization of curves and surfaces, vector fields, divergence and curl. Line integrals, Green's theorem, surface integral, Gauss and Stokes' theorems with applications.

MTL101 Linear Algebra and Differential Equations

4 Credits (3-1-0)

Vector spaces over \mathbb{Q} , \mathbb{R} and \mathbb{C} , subspaces, linear independence, linear span of a set of vectors, basis and dimension of a vector space, sum and direct sum.

Systems of linear (homogeneous and non-homogeneous) equations, matrices and Gauss elimination, elementary row operations, row space, column space, null space and rank of a matrix.

Linear transformation, rank-nullity theorem and its applications, matrix representation of a linear transformation, change of basis and similarity.

Eigenvalues and eigenvectors, characteristic and minimal polynomials, Cayley-Hamilton theorem (without proof) and applications.

Review of first order differential equations, Picard's theorem, linear dependence and Wronskian. Dimensionality of space of solutions, linear ODE with constant coefficients of second and higher order, Cauchy-Euler equations, Method of undetermined coefficients and method of variation of parameters. Boundary Value Problems: Sturm-Liouville eigenvalue problems. System of linear differential equations with constant coefficients, fundamental matrix, matrix methods. Power Series and its convergence, power series method, Fourier series, Laplace Transform Method.

MTL102 Differential Equations

3 Credits (3-0-0)

Overlaps with: MTL260

Systems of differential equations, Existence and uniqueness theorems for initial value problems of semilinear and nonlinear ODEs, continuous dependence and well-posedness; Comparison theorems of Sturm, Sturm-Liouville eigenvalue problems; Phase-plane analysis, Linear and Non-linear stability, Liapunov functions and applications; First order Partial differential equations, Method of characteristics, local and global solutions, envelop of solutions, complete and general solutions; Second order equations: Heat and Wave equation, fundamental solutions, method of eigenfunctions, Duhamel's principle. Maximum principles for Heat and Laplace equation, Greens functions.

MTL103 Optimization Methods and Applications

3 Credits (3-0-0)

Overlaps with: MTL508, CLL782, MCL261

Linear programming - formulation through examples from engineering/business decision making problems, preliminary theory and geometry of linear programs, basic feasible solution, simplex method, variants of simplex method. Duality and its principles, interpretation of dual variables, dual simplex method. Linear integer programming, applications in real decision making problems, methods to solve linear integer programs, transportation problems: theory and methodology, assignment problems. Zero-sum matrix games, saddle point, linear programming formulation of matrix games, network optimization problems LPP formulation. Nonlinear programming, Lagrange function, KKT optimality conditions, sufficiency of KKT under convexity of quadratic programming, Wolfe's method, applications of quadratic programs.

MTL104 Linear Algebra and Applications

3 Credits (3-0-0)

Pre-requisite(s): MTL101

Overlaps with: MTL502

Introduce Fields: fields of numbers, finite fields. Review basis and dimension of a vector space, linear transformations, eigenvalue and eigenvector of an operator. LU Factorization. Some applications giving rise to Linear Systems Problems

Dual and double dual of a vector space and transpose of a linear transformation. Diagonalizability of linear operators of finite dimensional vector spaces, simultaneous triangulization and simultaneous diagonalization. The primary decomposition theorem - diagonal and nilpotent parts.

Inner product spaces, Gram-Schmidt orthogonalization, best approximation of a vector by a vector belonging a given subspace and application to least square problems. Adjoint of an operator, hermitian, unitary and normal operators. Singular Value Decomposition and its applications. Spectral decomposition. Introduction of bilinear and quadratic forms.

MTL105 Algebra

3 Credits (3-0-0)

Overlaps with: MTL501

Preliminaries: Equivalence relations and partitions.

Groups: Subgroups, Cyclic groups, Abelian groups, permutation groups; Langrange's theorem, normal subgroups, quotient groups, isomorphism theorems. Direct product of groups, structure theorem of finitely generated abelian groups, Sylow's theorems and applications.

Rings: Definition and examples, units and zero divisors. Ideals and quotients, principal ideals, prime ideals, maximal ideals, integral domain, PID, Euclidean domain, UFD. Modules over a commutative ring with unity: Free module, quotient module, exact sequences. Fields: Finite fields, field extensions, splitting fields.

MTL106 Probability and Stochastic Processes

4 Credits (3-1-0)

Overlaps with: MTL108

Axioms of probability, Probability space, Conditional probability, Independence, Bayes' rule, Random variable, Some common discrete and continuous distributions, Distribution of Functions of Random Variable, Moments, Generating functions, Two and higher dimensional distributions, Functions of random variables, Order statistics, Conditional distributions, Covariance, Correlation coefficient, conditional expectation, Modes of convergences, Laws of large numbers, Central limit theorem, Definition of Stochastic process, Classification and properties of stochastic processes, Simple Markovian stochastic processes, Gaussian processes, Stationary processes, Discrete and continuous time Markov chains, Classification of states, Limiting distribution, Birth and death process, Poisson process, Steady state and transient distributions, Simple Markovian queuing models ($M/M/1$, $M/M/1/N$, $M/M/c/N$, $M/M/N/N$, $M/M/\infty$).

MTL107 Numerical Methods and Computations

3 Credits (3-0-0)

Overlaps with: MTL509, CLL113, CVL763

Errors in computation: source and types of errors, error propagation. Computer representation of numbers: floating point representation, rounding error and floating point arithmetic. Roots of nonlinear equation in one variable: Direct and iterative methods, order of convergence. Iterative methods for roots of nonlinear system of equations. Linear systems of equations: Direct and iterative methods, rate of convergence of iterative methods, Condition number and ill-conditioned systems. Interpolation: Lagrange, Newton divided difference formula, Newton's interpolations, errors in interpolation. Approximation: least square and uniform approximations. Differentiation: differentiation using interpolation formulas. Integration using interpolation: Newton-Cotes formulas, Gauss quadrature rules. Ordinary differential equations: Taylor, Euler and Runge-Kutta methods. Implementation of these methods.

MTL108 Introduction to Statistics

3 Credits (3-0-0)

Overlaps with: MTL106, MTL390

Measures of central tendency, Dispersion, Skewness, Kurtosis, Data Representation using Histogram, Pie Chart, Boxplot, Biplot, Multi Dimensional Scaling etc. Concept of Random Variable, Some common discrete and continuous distributions, Distribution of Functions of Random Variables, Bivariate and Multivariate random variables. Sampling Distribution, Theory of Estimation, Properties of an estimator, Cramer Rao Theorem, Rao Blackwellization, One-sample and Two sample tests of Proportion, mean, variance, Critical regions, Neyman Pearson Lemma. Tests for Goodness of fit, Chi-square Test, Kolmogorov Smirnov Test, One sample and paired sample tests: Sign Test, Signed-rank Test, Run tests etc. Linear regression, Non-linear regression, Logit and Probit Methods.

MTL122 Real and Complex Analysis

4 Credits (3-1-0)

*Pre-requisite(s): MTL100**Overlaps with: MTL503, MTL506*

Metric spaces: Definition and examples. Open, closed and bounded sets. Interior, closure and boundary. Convergence and completeness. Continuity and uniform continuity. Connectedness, compactness and separability. Heine-Borel theorem. Pointwise and uniform convergence of real-valued functions. Equicontinuity. Ascoli-Arzelà theorem. Limits, continuity and differentiability of functions of a complex variable. Analytic functions, the Cauchy-Riemann equations. Definition of contour integrals, Cauchy's integral formula and derivatives of analytic functions. Morera's and Liouville's theorems. Maximum modulus principle. Taylor and Laurent series. Isolated singular points and residues. Cauchy's residue theorem and applications.

MTL145 Number Theory

3 Credits (3-0-0)

Divisibility: basic definition, properties, prime numbers, some results on distribution of primes; Congruences: basic definitions and properties, complete and reduced residue systems, theorems of Fermat, Euler & Wilson, application to RSA cryptosystem, linear congruences and Chinese Remainder theorem, quadratic congruences, and Quadratic Reciprocity law; Arithmetical functions: examples, with some properties and their rate of growth; Continued fractions, and their connections with Diophantine approximations, applications to linear and Pell's equations; Binary quadratic forms; Partition: basic properties and results; Diophantine equations: linear and quadratic, some general equations.

MTL146 Combinatorics

3 Credits (3-0-0)

Pre-requisite(s): MTL180

Basic counting techniques; principle of inclusion and exclusion; recurrences and generating functions; Systems of Distinct Representatives & Hall's theorem; Extremal Set theory; Projective and combinatorial geometries; Latin squares; Designs & Steiner Triple Systems; Ramsey theory.

MTL180 Discrete Mathematical Structures

4 Credits (3-1-0)

Overlaps with: COL202

Logic : Propositional Logic: language of propositional logic, truth table, natural deduction, predicate logic: language of predicate logic, Logical inference with Quantifiers. Proof techniques: Introduction to different standard proof techniques. Set Theory: Review of Basic Set Operations, cardinality of a set. Relations : Types of relations, operations of relations and applications, Poset, topological ordering; Congruence arithmetic; Combinatorics: Counting techniques: Pigeon Hole principle, inclusion exclusion principle, recurrence relation and generating function; Graph Theory : Graph as a discrete structure, Modeling applications using graphs, Hamiltonian graphs, Planar graphs, Graph coloring, Matching.

MTL260 Boundary Value Problems

3 Credits (3-0-0)

Pre-requisite(s): MTL100, MTL101

Sturm Liouville problem, Boundary Value Problems for nonhomogeneous ODEs, Green's Functions. Fourier Series and Integrals: Periodic Functions and Fourier Series, Arbitrary Period and Half-Range Expansions, Fourier Integral theorem and convergence of series Parabolic equations: Heat equation, Fourier series solution, Different Boundary Conditions, Generalities on the Heat Conduction Problems on bounded and unbounded domains and applications in Option pricing.

The Wave Equation: The Vibrating String, Solution of the Vibrating String Problem, d'Alembert's Solution, One-Dimensional Wave Equation

The Potential Equation: Potential Equation in a Rectangle, Fourier series method, Potential equation in Unbounded Regions, Fourier integral representations, Potential in a Disk and Limitations.

Higher Dimensions and Other Coordinates: Two-Dimensional Wave Equation: Derivation, Parabolic equation, Solution by Fourier series, Problems in Polar Coordinates, Temperature in a Cylinder, Vibrations of a Circular Membrane.

Finite dimensional approximations of solutions, piecewise linear polynomials and introduction to different methods like Galerkin and Petrov-Galerkin method.

MTL265 Mathematical Programming Techniques

3 Credits (3-0-0)

*Pre-requisite(s): MTL103**Overlaps with: COL756*

Recall of linear programming simplex algorithm and dual problem; primal-dual simplex method, linear programs with upper bounds, network optimization, network simplex method for non-capacitated and capacitated networks; dynamic programming, principle of optimality, general insight followed by in-depth examples; complexity of simplex algorithm, Karmarkar's interior point method; nonlinear programming, KKT conditions, convex programs, linear fractional programming problems, Charnes and Cooper technique, convex simplex method, Rosen projection method; multiobjective programming problems, applications to engineering and sciences, Pareto efficient solution, linear multiobjective programs, weighted sum approach, scalarization schemes, goal programming.

MTL270 Measure Integral and Probability

3 Credits (3-0-0)

Overlaps with: MTL510

Measurable spaces, measurable sets, measurable functions, measure, outer measures and generation of measure, Lebesgue integration, basic integration theorem, comparison of Lebesgue and Riemann integrals, various modes of convergence of measurable functions, signed measure, Hahn and Jordan decomposition theorems, the Radon-Nikodym theorem, product measures and Fubini's theorem, probability measures and spaces, independent events, conditional probability, theorem of total probability, random variables, distribution and distribution function of a random variable, independent random variable, expectation, convergence in distribution of a sequence of random variables, weak and strong laws of large numbers, Kolmogorov's zero-one law, the central limit theorem, identically distributed summands, the Linderberg and Lyapounov theorems.

MTP290 Computing Laboratory

2 Credits (0-0-4)

Pre-requisite(s): MTL101

Programming concepts. Implementation of matrix operations, Complexity in Matrix Operations, Implementation of linear algebra solvers; solution of systems of linear equations. Gauss elimination, LU decomposition and Iterative methods. Implementation of several Numerical Integration algorithms, Initial value problems and Boundary Value Problems for ODEs.

MTL342 Analysis and Design of Algorithms

4 Credits (3-1-0)

Pre-requisite(s): MTL180

Overlaps with: COL351

Models of computation: RAM and Turing Machines; Algorithm Analysis techniques; Basic techniques for designing algorithms: dynamic programming, divide-and-conquer and Greedy; DFS, BFS and their applications; Some Basic Graph Algorithms; linear time sorting algorithms; NP-Completeness and Approximation Algorithms.

MTD350 Mini Project

3 Credits (0-0-6)

Pre-requisite(s): EC 80

Depends on the project topic.

MTL390 Statistical Methods

4 Credits (3-1-0)

Pre-requisite(s): MTL106

Overlaps with: MTL108

Basic concepts and Data Visualization: Measures of central tendency, Dispersion, Skewness, Kurtosis, Data Representation using Histogram, Pie Chart, Boxplot, Biplot, Multi Dimensional Scaling etc. Revision of Probability Distribution: Emphasis on Normal, Chi-Square, Student's T, F distributions; Order Statistics: Different Order Statistics and their single and joint Distribution; Sampling Distribution of Mean, Variance; Generation of Random Numbers following certain distributions; Theory of Estimation (Point and Interval) Properties of an estimator, MVUE, BLUE, Cramer-Rao Inequality, Rao-Blackwell Theorem; Testing of Hypothesis: Mean and Variance, Confidence Interval, Neyman-Pearson Lemma; Non-Parametric Methods Run Tests, Rank Tests, Signed Rank Tests, Kruskal Wallis Test, Kolmogorov-Smirnov Test etc.; Regression Analysis Linear Regression, Multiple Regression, Logit, Probit, Regression.

MTL411 Functional Analysis

3 Credits (3-0-0)

Pre-requisite(s): MTL104 and MTL122

Overlaps with: MTL602

Review of some basic concepts in metric spaces and topological spaces; Normed linear spaces and Banach spaces, Examples of Banach spaces, Bounded linear operators and examples, Finite dimensional Banach spaces; Introduction of Lebesgue integration on real line, Fatou's lemma, monotone convergence theorem, dominated convergence theorem, L_p spaces; Hahn Banach extension theorem, Hahn Banach separation theorem, Uniform boundedness principle, Open mapping theorem, Closed graph theorem; Characterization of dual of certain concrete Banach spaces; Schauder basis and separability, Reflexive Banach spaces, Best approximation in Banach spaces; Hilbert spaces and their geometry; Basic operator theory.

MTL415 Parallel Algorithms

3 Credits (3-0-0)

Pre-requisite(s): MTL342

Overlaps with: MTL765

Parallel architecture: Shared/local memory systems, pipelining, hypercubes, mesh, linear array etc. Degree of parallelism, Speed-up and efficiency of a parallel algorithm. Principles of parallel algorithm design. Basic communication operations. Parallel algorithms: searching and sorting, matrix-vector and matrix-matrix multiplication for dense, band and triangular matrices. Parallel algorithms for direct methods for dense, band and triangular matrices. Cholesky method. Solving recurrence relations. Parallel iterative methods for finite difference equations of elliptic boundary value problems: point-Jacobi, line Jacobi, block Jacobi methods, 2 colour and multicolour Gauss-Seidel, SOR, SSOR methods. Domain decomposition method in one and two dimensions. Parallel preconditioned conjugate gradient methods. Quadrant interlocking factorization.

MTD421 B.Tech. Project

4 Credits (0-0-8)

Pre-requisite(s): EC 100

Contents will be related to topic from the courses undertaken by the student in the programme.

MTL445 Computational Methods for Differential Equations

4 Credits (3-0-2)

Pre-requisite(s): MTL107

Overlaps with: MTL712, CLL113

Numerical methods for solving IVPs for ODEs: Difference equations, Routh-Hurwitz criterion, Test Equation. Single step methods: Taylor series method, explicit Runge-Kutta methods, convergence, order, relative and absolute stability. Multistep methods: Development of linear multistep method using interpolation and undetermined parameter approach, convergence, order, relative and absolute stability, Predictor Corrector methods. Solution of initial value problems of systems of ODEs. BVP: Finite difference methods for second order ODEs, Eigenvalue problems.

PDEs: Finite difference methods for Elliptic PDEs, Consistency, stability and convergence. Boundary Conditions. FD methods for Parabolic equations in 1D and 2D. Operator splitting methods, Convergence, stability and consistency of difference methods. Higher order methods. Introduction to Hyperbolic PDEs, FD methods. Upwind schemes, Consistency, stability and convergence of schemes. Second order schemes.

MTL458 Operating Systems

4 Credits (3-0-2)

Pre-requisite(s): MTL342

Overlaps with: COL331, ELL405

Operating Systems functions, Basic Concepts, Notion of a process, concurrent processes, problem of mutual exclusion, Deadlock, process Scheduling, memory management, multiprogramming, File systems; time sharing systems and their design consideration.

MTL501 Algebra

4 Credits (3-1-0)

Groups, subgroups, Lagrange theorem, quotient groups, isomorphism theorems; cyclic groups, dihedral groups, symmetric groups, alternating groups; simple groups, simplicity of alternating groups; Group action, Sylow theorems and applications; free abelian groups, structure of finitely generated abelian groups; Solvable and nilpotent groups, composition series, Jordan-Holder theorem.

Rings, examples: polynomial rings, formal power series, matrix rings, group rings; prime ideals, maximal ideals, quotient rings, isomorphism theorems; Integral domains, PID, UFD, Euclidean domains, division rings, field of fractions; primes and irreducibles, irreducibility criteria; product of rings, Chinese remainder theorem.

Field extension, algebraic extension, algebraic closure, straight edge and compass constructions, splitting fields, separable and inseparable extensions, fundamental theorem of Galois theory; solvability by radicals.

MTL502 Linear Algebra

4 Credits (3-1-0)

Revision of existence-uniqueness of solutions of a system of linear equations, elementary row operations, row-reduced echelon matrices.

Vector spaces, span of a subset, bases and dimension, quotient spaces, direct sums. Linear transformations, rank-nullity, matrix representation of a linear transformation, algebra of linear transformations, dual space, transpose of a linear transformation. Eigenvalues, eigenvectors, annihilating polynomials, Cayley-Hamilton theorem, invariant subspaces, triangulable and diagonalizable linear operators. Simultaneous triangulation and diagonalization, Primary decomposition theorem, Jordan decomposition.

Inner product spaces over \mathbb{R} (real numbers) and \mathbb{C} (complex numbers), Gram-Schmidt orthogonalization process, orthogonal projection, best approximation. Adjoint of a linear operator, unitary and normal operators, spectral theory of normal operators. Bilinear forms, symmetric and skew-symmetric bilinear forms.

MTL503 Real Analysis

4 Credits (3-1-0)

Elementary set theory, Countable and Uncountable sets, Real number system and its order completeness.

Metric spaces, Continuous and uniformly continuous functions, Homeomorphism and isometry, Completeness, Fixed Points, Baire's Category Theorem, Totally bounded metrics, Compactness, Connectedness.

Sequences and series of functions, Pointwise and uniform convergence of sequences of functions, Equicontinuity, Arzelà-Ascoli Theorem, Dini's Theorem, Stone-Weierstrass Theorems (Lattice and algebra versions).

Functions of several variables, Linear transformations, Differentiation, Inverse function theorem, Implicit Function theorem, Derivatives of higher order.

MTL504 Ordinary Differential Equations

4 Credits (3-1-0)

Initial value problems, Cauchy-Picard Theorem. General theory of linear differential systems. Sturm's theory on separation and comparison properties of solutions, Boundary value problems, Green functions, Sturm-Liouville problems, Weyl-Titchmarsh theorem for unbounded interval- limit cycle, limit point cases. Power series method, regular singular points, Legendre and Bessel equations, Linear system with constant coefficients, fundamental matrix, linear systems with periodic coefficients. Critical points, phase plane analysis and concepts of linear and nonlinear stability. Autonomous systems and applications.

MTL505 Computer Programming

4 Credits (3-1-0)

Introduction to Computers - CPU, ALU, I/O devices,

Introduction to C Programming - Data types, Looping Statements, Arrays, Structure, Functions (Both simple and Recursive function), Call by Value and Call by reference, Pointers, File Handling in C

Introduction to C++ Programming , Looping Statements ,arrays and Structures in C++, Functions in C++, Basic OOPS concepts.

MTL506 Complex Analysis

4 Credits (3-1-0)

Field of complex numbers, complex plane, polar representation, stereographic projection.

Analytic functions, Cauchy-Riemann equation, harmonic conjugates, power series, Möbius transforms.

Contour integrals, power series representation of an analytic function, zeros of an analytic function, Liouville's theorem and applications.

Index of a closed curve, Cauchy's theorem, Cauchy integral formula, Open mapping theorem, Goursat's theorem.

Isolated singularities, Laurent Series, Residue theorem and application to real integrals. Meromorphic functions, Argument principle and Rouché's theorem.

Maximum modulus principle and Schwarz's Lemma.

MTL507 Topology

4 Credits (3-1-0)

Topological spaces: Definitions and Examples, Basis and Subbasis for a Topology, limit points, closure, interior; Continuous functions, Homeomorphisms; Subspace Topology, Metric Topology, Product & Box Topology, Order Topology; Quotient spaces.

Connectedness and Compactness: Connectedness, Path connectedness; Connected subspaces of the real line; Components and local connectedness; Compact spaces, Limit point compactness, Sequential compactness; Local compactness, One point compactification;

Tychonoff theorem, characterizations of compact metric spaces.

Countability Axioms: First countable spaces, Second countable spaces, Separable spaces, Lindelöf spaces.

Separation Axioms: Hausdorff, Regular and Normal spaces; Urysohn's lemma; Urysohn's Metrization theorem; Tietze extension theorem.

Completely metrizable spaces, Baire's category theorem and Function Spaces.

MTL508 Mathematical Programming

4 Credits (3-1-0)

Linear programs formulation through examples from engineering/business decision making problems, preliminary theory and geometry of linear programs, basic feasible solution, simplex method, variants of simplex method, like two phase method and revised simplex method; duality and its principles, interpretation of dual variables, dual simplex method, primal-dual method; linear integer programs, their applications in real decision making problems, cutting plane and branch and bound methods, transportation problems, assignment problems, network maximum flow problems; complexity of simplex method, ellipsoid method, Karmarkar's interior point method; nonlinear programming, Lagrange multipliers, Farkas lemma, constraint qualification, KKT optimality conditions, sufficiency of KKT under convexity; quadratic programs, Wolfe method, applications of quadratic programs in some domains like portfolio optimization and support vector machines, etc.

MTL509 Numerical Analysis

4 Credits (3-1-0)

Numerical Algorithms and errors, Floating point systems, Roundoff error accumulations. Interpolation: Lagrange Interpolation Newton's divided difference interpolation. Finite differences. Hermite Interpolation. Cubic splines. Numerical differentiation. Numerical Integration: Newton cotes formulas, Gaussian Quadrature composite quadrature formulas

Approximation: Least squares approximation, minimum maximum error techniques. Legendre and Chebyshev polynomials. Solution of Nonlinear equations: Fixed point iteration, bisection, Secant, Regula-Falsi, Newton-Raphson methods. Solution of linear systems: Direct methods, Gauss elimination, LU and Cholesky factorizations. Iterative methods – Jacobi, Gauss-Seidel and SOR methods. System of nonlinear equation, Eigen-Value problems: Power and Inverse power method. Numerical Solution of ODE. Taylor series, Euler and Runge-Kutta methods.

MTL510 Measure and Integration

4 Credits (3-1-0)

Outer measures, measures and measurable sets, Lebesgue measure on \mathbb{R} , Borel measure

Measurable functions, simple functions, Egoroff's theorem, Lebesgue integral and its properties, monotone convergence theorem, Fatou's Lemma, Dominated convergence theorem various modes of convergence and their relations

Signed measures, Hahn and Jordan decomposition theorems, Lebesgue-Radon-Nikodym theorem, Lebesgue decomposition theorem, the representation of positive linear functionals on $C_c(X)$

Product measures, iterated integrals, Fubini's and Tonelli's theorems L_p spaces and their completeness, conjugate space of L_p for $1 < p < \infty$, conjugate space of L_1 for sigma-finite measure space

Differentiation of monotone functions, functions of bounded variation, differentiation of an integral, absolute continuity.

MTL601 Probability and Statistics

4 Credits (3-1-0)

Probability definition, conditional probability, Bayes theorem, random variables, expectation and variance, specific discrete and continuous distributions, e.g. uniform, Binomial, Poisson, geometric, Pascal, hypergeometric, exponential, normal, gamma, beta, moment generating function, Poisson process, Chebyshev's inequality, bivariate and multivariate distributions, joint, marginal

and conditional distributions, order statistics, law of large numbers, central limit theorem, sampling distributions - Chi-sq, Student's t, F, theory of estimation, maximum likelihood test, testing of hypothesis, nonparametric analysis, test of goodness of fit.

MTL602 Functional Analysis

4 Credits (3-1-0)

Normed linear spaces, Banach spaces and their examples, quotient spaces, bounded linear operators, finite dimensional Banach spaces, Lp Spaces, Lp spaces as examples for Banach spaces

Hahn Banach theorems, Uniform boundedness principle, open mapping theorem, closed graph theorem, transpose of an operator
Characterization of the dual of certain Banach spaces

Geometry of Banach spaces - Weak and weak* convergence,

Geometry of Hilbert spaces - Inner product spaces and its properties, Hilbert spaces and examples, best approximation in Hilbert spaces, orthogonal complements, orthonormal basis, dual of a Hilbert space

Basic operator theory - Adjoint of an operator, self-adjoint operators, normal and unitary operators, projections

Compact operators, examples and properties, spectral theorem for the compact self-adjoint operator.

MTL603 Partial Differential Equations

4 Credits (3-1-0)

Linear and semi-linear equations, Cauchy problem, Method of characteristics. Cauchy-Kowalewsky theorem, Holmgren's Uniqueness Theorem. Classification of second order equations, wave equation in one space dimension, classical and weak solutions, Duhamel's principle. Laplace equation, fundamental solutions, maximum principles and mean value formulas, Properties of harmonic functions, Green's function, Energy methods, Perron's method, Parabolic equations in one space dimension, fundamental solution, maximum principle, existence and uniqueness theorems. Wave equation, Solutions by spherical means, Non-Homogeneous Problems, Duhamel's principle, Energy Methods. Nonlinear first order PDE's: Complete integrals, Envelopes and singular solutions. Some special methods for finding solutions: Similarity solutions, Hopf-Cole transformation.

MTL625 Principles of Optimization Theory

3 Credits (3-0-0)

Convex set, hyperplane, relative interior and closure, separation theorems, theorems of alternatives for linear systems, convex functions and properties of continuity, differentiability etc., quasiconvex and pseudoconvex functions and their properties and interrelationships, minimax theorems for convex and quasiconvex functions, nonlinear programming, Lagrange function, saddle point, Fritz John optimality conditions, constraint qualifications, Karush-Kuhn-Tucker (KKT) necessary and sufficient optimality conditions, Wolfe and Mond-Weir duals, Wolfe method for quadratic programs, Projection gradient method, steepest descent method, conjugate gradient method, rank-1 methods, convergence, conjugate function, Fenchel duality, subgradient and subdifferential, nonsmooth optimization, tangent cone, normal cone, nonsmooth KKT conditions, nonsmooth optimality conditions, subgradient method, proximal method, convergence of these methods, applications to support vector machines optimization problems.

MTD701 Project-I

5 Credits (0-0-10)

MTD702 Project-II

6 Credits (0-0-12)

MTL704 Numerical Optimization

3 Credits (3-0-0)

Pre-requisite(s): MTL103/MTL508

Unconstrained optimization techniques - one dimensional methods like Fibonacci method, Golden section method; higher dimension methods:

pattern search method, Nelder and Meed method; gradient based methods: Steepest descent method, Newton method, Conjugate direction and gradient method, Quasi-Newton methods. Constrained optimization techniques - penalty method, barrier method, cutting plane method, projection gradient method. Heuristic technique: like Genetic programming method to solve non-convex programs.

MTL712 Computational Methods for Differential Equations

4 Credits (3-0-2)

Pre-requisite(s): MTL107/MTL509

Numerical methods for solving IVPs for ODEs: Difference equations, Routh-Hurwitz criterion, Test Equation. Single step methods: Taylor series method, explicit Runge-Kutta methods, convergence, order, relative and absolute stability. Multistep methods: Development of linear multistep method using interpolation and undetermined parameter approach, convergence, order, relative and absolute stability, Predictor Corrector methods. Solution of initial value problems of systems of ODES. BVP: Finite difference methods for second order ODEs, Eigenvalue problems.

PDEs: Finite difference methods for Elliptic PDEs, Consistency, stability and convergence. Boundary Conditions. FD methods for Parabolic equations in 1D and 2D. Operator splitting methods, Convergence, stability and consistency of difference methods. Higher order methods. Introduction to Hyperbolic PDEs, FD methods. Upwind schemes, Consistency, stability and convergence of schemes. Second order schemes.

MTL717 Fuzzy Sets and Applications

3 Credits (3-0-0)

Fuzzy sets, fuzzy relations, matrix representation of fuzzy relations, fuzzy numbers, fuzzy arithmetic, Zadeh's extension principle, ordering fuzzy numbers, ranking functions; Fuzzy aggregation, t-norm, t-conorm, fuzzy negation, other aggregation operators, OWA operators; Fuzzy relational equations (FRE), algorithms to solve system of FRE; Fuzzy optimization, fuzzy linear program; Fuzzy measures, belief and plausibility, necessity and possibility, Sugeno and Choquet integrals on finite sets; Fuzzy logic and approximate reasoning, If-then-else rules, Mamdani model, TSK model, SAM model; Applications of fuzzy sets and logics in areas of image processing, control, AI, computing with words, etc.; Generalized fuzzy sets - like type2 fuzzy sets, rough sets, and Intuitionistic fuzzy sets.

MTL720 Neurocomputing and Applications

3 Credits (3-0-0)

Biological and Artificial Neuron, Perceptron model, Adaline model, Multilayered feedforward networks, Activation functions, Back-propagation algorithm and its improvements, Conjugate Gradient Neural Network, Applications of Back-propagation algorithm to Statistical Pattern Classification, Feature selection, Classification and regression problems, General Regression Neural Networks, Hopfield Network, Recurrent networks, Probabilistic Neural Networks, Kohonen's self-organizing maps with quadratic junctions and its applications to character recognition, Adaptive Resonance Theory model, Applications of ART model for knowledge acquisition.

MTL725 Stochastic Processes and its Applications

3 Credits (3-0-0)

Stochastic processes, specification of stochastic processes, stationary processes, discrete time and continuous time Markov chains, birth and death processes, applications in queueing theory. Markov processes with continuous state space, martingales, applications in financial mathematics. Renewal processes and theory, Markov renewal and semi-Markov processes, branching processes.

MTL728 Category Theory

3 Credits (3-0-0)

Categories, functors and natural transformations, adjoints (of functors), representable functors, Yoneda Lemma and applications. Limits and colimits, interaction between functors and limits. Limits in

terms of representables and adjoints, limits and colimits of presheaves, interaction between adjoint functors and limits. Application to abelian category: complexes of R-modules, long exact sequence, mapping cone and cylinder, projective and injective resolution, derived functors, right and left exactness, Ext and Tor. Concept of presheaf and sheaf, group scheme and Hopf algebra.

MTL729 Computational Algebra and its Applications

3 Credits (3-0-0)

Finite fields: Construction and examples. Polynomials over finite fields, their factorization/irreducibility and their applications to coding theory. Combinatorial applications. Symmetric and Public key cryptosystems particularly on Elliptic curves. Combinatorial group theory: investigation of groups on computers, finitely presented groups, coset enumeration. Fundamental problem of combinatorial group theory. Coset enumeration, Nielsen transformations. Braid Group cryptography. Automorphism groups. Computational methods for determining automorphism groups of certain finite groups. Computations of characters and representations of finite groups. Computer algebra programs. Computations of units in rings and group rings. Calculations in Lie algebras.

MTL730 Cryptography

3 Credits (3-0-0)

Overlaps with: COL759

Applying the corresponding algorithms programmes. (laboratory/design activities could also be included) Classical cryptosystems, Preview from number theory, Congruences and residue class rings, DES- security and generalizations, Prime number generation. Public Key Cryptosystems of RSA, Rabin, etc. their security and cryptanalysis. Primality, factorization and quadratic sieve, efficiency of other factoring algorithms.

Finite fields: Construction and examples. Diffie-Hellman key exchange.

Discrete logarithm problem in general and on finite fields. Cryptosystems based on Discrete logarithm problem such as Massey-Omura cryptosystems. Algorithms For finding discrete logarithms, their analysis. Polynomials on finite fields and Their factorization/irreducibility and their application to coding theory.

Elliptic curves, Public key cryptosystems particularly on Elliptic curves. Problems of key exchange, discrete logarithms and the elliptic curve logarithm problem.

Implementation of elliptic curve cryptosystems. Counting of points on Elliptic Curves over Galois Fields of order $2m$. Other systems such as Hyper Elliptic Curves And cryptosystems based on them. Combinatorial group theory: investigation of groups on computers, finitely presented groups, coset enumeration. Fundamental problems of combinatorial group theory. Coset enumeration, Nielsen and Tietze transformations. Braid Group cryptography.

Cryptographic hash functions. Authentication, Digital Signatures, Identification, certification infrastructure and other applied aspects.

MTL731 Introduction to Chaotic Dynamical Systems

3 Credits (3-0-0)

Topics to be covered include chaos, elementary bifurcations. Sarkovski's theorem, recurrence and equidistribution, codes, symbolic dynamics and chaotic behaviour. Higher dimensional dynamics, including horseshoes, Henon map. Stability of systems.

MTL732 Financial Mathematics

3 Credits (3-0-0)

Pre-requisite(s): MTL103/MTL508

Overlaps with: MCL363/MSL873

Financial markets, Interest computation, value, growth and discount factors, derivative products, basic option theory: single and multi-period binomial pricing models, Cox-Ross-Rubinstein (CRR) model, volatility, Black-Scholes formula for option pricing as a limit of CRR model, Greeks and hedging, Mean-Variance portfolio theory: Markowitz model, Capital Asset Pricing Model (CAPM), factor models, interest rates and interest rate derivatives, Binomial tree models.

MTL733 Stochastic of Finance

3 Credits (3-0-0)

Pre-requisite(s): MTL106/MTL601

Stochastic Processes; Brownian and Geometric Brownian Motion; Levy Processes, Jump-Diffusion Processes; Conditional Expectations and Martingales; Ito Integrals, Ito's Formula; Stochastic Differential Equations; Change of Measure, Girsanov Theorem, Martingale Representation Theorem and Feymann-Kac Theorem; Applications of Stochastic Calculus in Finance, Option Pricing, Interest Rate Derivatives, Levy Processes in Credit Risk.

MTL735 Advanced Number Theory

3 Credits (3-0-0)

Overlaps with: MTL145

Divisibility, prime numbers, Bertrand's theorem, Congruences, complete & reduced residue systems, theorems of Fermat, Euler, Wilson & Wolstenholme, solutions of general congruences, study of linear and system of linear congruences, Chinese Remainder theorem, study of quadratic congruences, Quadratic, Cubic & Biquadratic Reciprocity laws, binary and ternary quadratic forms, Continued fractions, Diophantine approximations and applications to linear and Pell's equations, Arithmetical functions, properties, rate of growth, Distribution of primes, Dirichlet's theorem on primes in arithmetic progression, Prime Number theorem, Diophantine equations, special cases of the Fermat equation, introduction to classic and modern techniques.

MTL737 Differential Geometry

3 Credits (3-0-0)

Curves in plane and space, arc-length, reparametrization, curvature of a plane curve, curvature and torsion of a space curve

Simple closed curves, isoperimetric inequality, Four-vertex theorem Surfaces, smooth surfaces and examples, level surfaces, quadric surfaces, surfaces of revolution, ruled surfaces smooth maps, tangent space, derivatives, orientability of surfaces

The first fundamental form, lengths of curves on surfaces, isometries, conformal mappings, equiareal maps

The second fundamental form, Gauss and Weingarten maps, normal and geodesic curvatures, Gaussian and mean curvatures, principal curvatures

Surfaces of constant Gaussian curvature, surfaces of constant mean curvature, flat surfaces

Parallel transport, geodesics and their examples, properties, geodesic equations, geodesics as shortest paths, Gauss and Codazzi-Minardi equations, Theorema Egregium

Gauss-Bonnet Theorem. Introduction to hyperbolic and spherical geometry.

MTL738 Commutative Algebra

3 Credits (3-0-0)

Pre-requisite(s): MTL105/MTL501

Revision of Rings and Ideals: Prime and maximal ideals. Chinese remainder theorem, Nilradical, Jacobson radical, operations on ideals, extension and contraction; Module, submodule, quotient module, sums and products, Nakayama's lemma; Homomorphism, kernel, cokernel, direct sum, direct product, universal properties, free module, exact sequences, tensor product of modules and its exactness property; Rings and modules of fractions and functorial properties of fractions; Primary decomposition; Integral dependence, going-up and going down theorems, valuation rings; Chain conditions, Noetherian rings, Artinian rings, discrete valuation ring and Dedekind domains, fractional ideals; Completion: filtration, graded rings and modules.

MTL739 Representation of Finite Groups

3 Credits (3-0-0)

Pre-requisite(s): MTL105/MTL501

Revision of basic group theory. Definition and examples of representation. Subrepresentation, sum and tensor product of representations,

irreducible representations; Character Theory: Character of a representation, Schur's Lemma, Maschke's theorem, Orthogonality relations for characters, decomposition of regular representation, number of irreducible representations of a group; Representation of subgroups and product of groups, induced representations; Group Algebra: Representations and modules; Decomposition of complex algebra $C[G]$ and Integrability properties of characters. Induced representations, restriction to subgroups, Reciprocity formula, Mackey's irreducibility criterion; Irreducible representations of symmetric groups (S_n) and alternating groups (A_n).

MTL741 Fractal Geometry

3 Credits (3-0-0)

Code spaces, Hausdorff metric, Hausdorff measures, fractal dimensions, Hausdorff dimension, Box-counting dimensions, groups and rings of fractal dimension, semigroups of iterated function schemes (IFS) and self-similarity, Cantor sets, Cantor dusts, Koch Snowflake, Sierpinski's triangle, Diophantine approximation, chaos games, attractors, fractals, superfractals and multi fractal measures, Mandelbrot and Julia sets, random fractals, fractals in Brownian motion.

MTL742 Operator Theory

3 Credits (3-0-0)

Pre-requisite(s): MTL411/MTL602

Weak and weak*-topologies, closed convex sets, weak compactness, Alaoglu's theorem, locally convex topologies, separation of points by linear functionals, Krein-Milman theorem, Stone-Weierstrass theorem. Normed algebras, resolvent, spectrum, spectral radius, functional calculus, spectral mapping theorem, Gelfand's theory of commutative Banach algebras.

Basic properties of compact operators, spectral theory of compact operators, Fredholm alternative, General theory of Schatten-von Neumann classes, Hilbert-Schmidt operators, trace and trace duality in finite dimensions, duality for Schatten-von Neumann classes.

Functional calculus for self-adjoint operators, square root of positive operators, polar decomposition, some topologies on $B(H)$, spectral measures, the spectral theorem for normal operators.

MTL743 Fourier Analysis

3 Credits (3-0-0)

Pre-requisite(s): MTL122/MTL503

Fourier Series - Definition, uniqueness, convolution, summability, convergence of Fourier series, Fourier series for square integrable functions, Plancherel theorem, Riesz-Fischer theorem, Gibbs' phenomenon, divergence of Fourier series

Applications of Fourier series – Isoperimetric inequality, Weierstrass approximation theorem, Weyl's equidistribution theorem, heat equation on the circle.

Fourier transform – Schwartz space on \mathbb{R} , Fourier transform on the Schwartz space, Fourier transform of integrable and square-integrable functions, Poisson summation formula.

Tempered distributions – Topology on the Schwartz space, tempered distributions and its properties, Fourier transform of tempered distributions.

Applications – Uncertainty principle, Paley-Wiener theorem, Wiener's theorem, Shannon sampling theorem, multiplier theorem for integrable functions.

MTL744 Mathematical Theory of Coding

3 Credits (3-0-0)

Pre-requisite(s): MTL105/MTL501

Overlaps with: ELL710

Review of communication channels, maximum likelihood and nearest neighbour decoding schemes, Hamming distance, Distance of a code. Structure of finite fields, Linear codes and their duals, Equivalence of linear codes, encoding with a linear code, decoding of a linear code, ISBN Code, Hamming codes. Hadamard matrix codes, Golay codes, Codes and Latin squares. Non-linear codes, Nordstrom-Robinson code,

Kerdock codes, Preparata codes. Bounds in coding theory: Sphere-covering bound, Hamming bound and perfect codes, Singleton bound and MDS codes, Gilbert-Varshamov bound, Plotkin bound, Griesmer bound. Weight enumerators, MacWilliams Identity. Construction of new codes: Propagation rules, Reed-Muller codes, subfield codes.

The structure of cyclic codes, encoding and decoding with a cyclic code, minimal codes, Some special cyclic codes including BCH codes and their decoding algorithm, Reed-Solomon codes, quadratic residue codes. Burst errors, Burst error-correcting codes, decoding of cyclic burst-error-correcting codes. Generalized Reed-Solomon codes, Alternant codes, Goppa codes, Sudan decoding for generalized RS codes.

MTL745 Advanced Matrix Theory

3 Credits (3-0-0)

Review of Linear Algebra; Matrix calculus, Diagonalization, Canonical forms and invariant Factors. Quadratic forms, Courant-Fischer minimax and related Theorems. Perron-Frobenius theory, Matrix stability, Inequalities, g-inverses. Direct, iterative, projection and rotation methods for solving linear systems and eigenvalue problems. Applications.

MTL746 Methods of Applied Mathematics

3 Credits (3-0-0)

Expansion in Eigen functions, Fourier series and Fourier Integral, orthogonal expansion, mean square approximation, completeness, orthogonal polynomials and their properties.

Integral transform and their applications.

Linear function, general variation of a functional, direct variation methods for solution of boundary value problems.

Integral equations of Volterra and Fredholm type, separable and symmetric kernels, Hilbert-Schmidt theory, Singular integral equations, approximation methods of solving integral equations.

MTL747 Mathematical Logic

3 Credits (3-0-0)

Propositional Logic - Syntax, Semantics and Normal Forms, First Order Logic Syntax, Semantics and Normal Forms, Herbrand interpretation, Resolution of PL and FL, Proofs in PL and FL, Axiomatic Systems, Adequacy and Compactness, Program Verification, Hoare Proof, Godel's completeness and incompleteness Theorem, Turing Machines and undecidability of Predicate calculus, Gentzen systems, Introduction to other logics - Description Logic, Default & Defeasible Logic, Courteous Logic, Modal Logic, Fuzzy logic.

MTL750 Harmonic Analysis and Its Applications

3 Credits (3-0-0)

Schauder bases in Banach spaces, Trigonometric system, Weak and weak* bases, Characterization of Schauder bases, duality of bases, perturbation of bases.

Absolute and unconditional convergence of series in a Banach space, Unconditional bases, Characterization, Schauder basis for $C([0,1])$ and its unconditionality.

Bessel sequences and Riesz bases in Hilbert spaces, Frames in a Hilbert space, Frame operator, Characterizations of frames, Frame series and its convergence.

Fourier transform of L^1 functions on \mathbb{R} , convolution of L^1 functions and its Fourier transform, Plancherel theorem.

Band limited functions, Sampling theorem, Frames of translates, Time-frequency shifts, Painless nonorthogonal expansions, Nyquist density, Necessary conditions for frame bounds, Wiener amalgam spaces, Zak transform, Gabor systems at the critical density, Balian-low theorem. Wavelet frames, Frame bounds, Admissibility criteria.

MTL751 Symbolic Dynamics

3 Credits (3-0-0)

Shift Spaces, languages, subshifts of finite type, their graph representation, sofic shifts, their presentation and characterization, entropy, its properties, conjugacy, shift equivalence and dimension groups, zeta functions.

MTL754 Principles of Computer Graphics

3 Credits (3-0-0)

Overlaps with: COL781, ELL792

Overview of Graphics Systems; Raster Graphics: line and circle drawing algorithms, Windowing and clipping: Cohen - Sutherland line clipping, Cyrus beck clipping method, Polygon Clipping; 2D and 3D Geometrical Transformations: scaling, translation, rotation, reflection; 3D Object representation: Curves and Surfaces: cubic splines, Bezier curves B-splines, surface of revolution, sweep surfaces; viewing Transformations: parallel and perspective projection; Hidden line/surface removal methods; illuminations model; shading: Gouraud, Phong; Introduction to Ray-tracing; Programming practices with standard graphics libraries like open GL.

MTL755 Algebraic Geometry

3 Credits (3-0-0)

Pre-requisite(s): MTL105/MTL501

Rings of polynomials and their quotients, local rings, DVR, modules, free modules, exact sequences. Affine algebraic sets, The Hilbert basis theorem. Hilbert's Nullstellensatz. Affine varieties: Coordinate rings, polynomial maps, coordinate changes, rational functions. Local Properties of plane curves: Multiple points, tangent lines, multiplicities and local rings, intersection number. Projective varieties: projective algebraic sets, projective plane curves, linear systems of curves, Bezout's theorem, Max Noether's fundamental theorem and its applications. Variety, Morphisms and Rational maps: The Zariski topology, varieties and their morphism, dimension of varieties, rational maps. Resolution of singularities: Blowing up a point in affine and projective planes, quadratic transformations and nonsingular models of curves.

MTL756 Lie Algebras and Lie Groups

3 Credits (3-0-0)

*Pre-requisite(s): MTL105/MTL501**Overlaps with: MTL856*

Definition and examples, solvable and nilpotent Lie algebras, the Engel's theorem, Lie's theorem, Cartan's theorem, Killing form. Representation theory of finite dimensional semisimple Lie algebras. The Weyl's theorem, representations of $sl(2, \mathbb{C})$, root space decomposition. Weyl group, Cartan subalgebras and classification of root systems; Definition and examples of matrix Lie groups. Exponential mapping, Baker-Campbell-Hausdorff formula. Representation theory of matrix Lie groups. Representation theory of $SU(2)$ and $SU(3)$.

MTL757 Introduction to Algebraic Topology

3 Credits (3-0-0)

Pre-requisite(s): MTL122/MTL507

Homotopy of paths, fundamental group, covering spaces, fundamental group of the circle, Retraction and application, van Kampen theorem and application. Universal cover and classification of covering spaces. Deck transformation and group actions. Simplicial and Singular homology, homotopy invariance, exact sequences- Mayer-Vietories Sequences, the equivalence of simplicial and singular homology.

MTL760 Advanced Algorithms

3 Credits (3-0-0)

*Pre-requisite(s): MTL342**Overlaps with: COL758*

MST: Fibonacci Heaps and $O(m \log \log n)$ time implementation of MST, Linear time MST verification Algorithm, A linear time randomized algorithm for MST, Finding min-cost arborescences; Dynamic Graph Algorithms; Review of NP-completeness; Introduction to NP-hard optimization problems; A brief introduction to LPP; Integer Programming Problem; Primal-Dual Algorithm; Approximation Algorithms: Primal-Dual Approximation Scheme; vertex cover, set cover, TSP; Hardness of Approximation; Introduction to Randomized Algorithms; Some basic Randomized algorithms; Probabilistic Method: Lovasz Local Lemma.

MTL761 Basic Ergodic Theory

3 Credits (3-0-0)

Measure spaces, Haar Measure, Poincare Recurrence Theorem, Hopf's Maximal Ergodic Theorem, Birkhoff's Ergodic Theorem, von Neumann's Ergodic Theorem, Isomorphism, Conjugacy and Spectral Isomorphism, Entropy, Topological Pressure and its relationship with Invariant Measures.

MTL762 Probability Theory

3 Credits (3-0-0)

Axiomatic definition of a probability measure, examples, properties of the probability measure, finite probability space, conditional probability and Bayes formula, countable probability space, general probability space.

Random variables, examples, sigma-field generated by a random variable, tail sigma-field, probability space on \mathbb{R} induced by a random variable.

Independent events, sigma-fields and random variables, Borel 0-1 criteria, Kolmogorov 0-1 criteria.

Distribution - definition and examples, properties, characterization, Jordan decomposition theorem, discrete, continuous and mixed random variables, standard discrete and continuous distributions, convolution of distributions.

Two dimension random variables, joint distributions, marginal distributions, operations on random variables and their corresponding distributions, multidimensional random variables and their distributions.

Expectation of a random variable, expectation of a discrete and a continuous random variable, moments and moment generating function, correlation, covariance and regression.

Various modes of convergence, Weak law of large numbers, strong law of large numbers.

Convergence in distribution, weak convergence of generalized distributions, Helly-Bray theorems, Scheffe's theorem.

Characteristic function - definition and examples, properties, uniqueness and inversion theorems, moments using characteristic function, Paul Levy's continuity property of characteristic functions, characterization of independent random variables.

Central limit theorem - Liapunov's and Lindberg's condition, Lindeberg-Levy form.

Infinite divisibility, Levy-Khintchine theorem.

MTL763 Introduction to Game Theory

3 Credits (3-0-0)

Game Trees, Choice Functions and Strategies, Choice Subtrees, Equilibrium N-tuples Strategies, Normal Forms, Non-cooperative games, Nash Equilibrium and its computation, The von Neumann Minimax Theorem, Mixed strategies, Best Response Strategies, Matrix Games and Linear Programming, Simplex Algorithm, Avoiding cycles and Achieving Feasibility, Dual-Simplex Algorithm, Duality Theorem, 2x2 Bimatrix Games, Nonlinear Programming Methods for Non-zero Sum Two-Person Games, Coalitions and Characteristic Functions, Imputations and their Dominance, The Core of a game, Strategic Equivalence, Stable Sets of Imputations, Shapley Values, N-Person Non-Zero Sum Games with continuum of strategies - Duels, Auctions, Nash Model with Security Point, Threats, Evolution, Stable Strategies, Population Games, Bayesian Games.

MTL766 Multivariate Statistical Methods

3 Credits (3-0-0)

Pre-requisite(s): MTL390/MTL601

Introduction to Multivariate data, Geometry of a sample, Mean and Covariance, Generalized Variance; Sample value of Linear combination of variables; Multivariate Normal Distribution, and its properties, Sampling from a Multivariate Normal population, Sampling distribution and Large sample Behaviour of Mean and Covariance, Inference about Mean Vector, Hotelling's T-square and Likelihood Ratio test, Confidence Region, Comparison of several Multivariate Populations, Multivariate Linear Regression Models, Inferences about regression models and parameters, Model checking, Principal Component

Analysis, Introduction to Factor Analysis, Orthogonal Factor Models, Factor Rotation, Strategy for Factor Analysis; Canonical Correlation Analysis, Interpreting population by Canonical variables, Large Sample Inferences.

MTL768 Graph Theory

3 Credits (3-0-0)

Overlaps with: MTL776

Introduction to Graphs: Definition and basic concepts; Trees: characterizations, counting of minimum spanning tree; Paths and Distance in Graphs: Basic Definitions, center and median of a graph, activity digraph and critical path; Eulerian Graphs: Definition and Characterization; Hamiltonian Graphs: Necessary and sufficient conditions, Planar Graphs: properties, dual, genus of a graph; Graph Coloring: vertex coloring, chromatic polynomials, edge coloring, planar graph coloring; Matching and Factorizations: maximum matching in bipartite graphs, maximum matching in general graphs, Hall's marriage theorem, factorization; Networks: The Max-flow min-cut theorem, connectivity and edge connectivity, Menger's theorem; Graph and Matrices.

MTL773 Wavelets and Applications

3 Credits (3-0-0)

Pre-requisite(s): MTL411/MTL602

Basic Fourier Analysis: Fourier Series, convergence of Fourier series, Riesz Fischer theorem, Fourier transform of square integrable functions, Plancherel formula, Poisson Summation formula, Shannon sampling theorem, Heisenberg Uncertainty principle. Continuous Wavelet transform, Plancherel formula, Inversion formulas. Frames, Riesz Systems, discrete wavelet transform, Numerical algorithms. Orthogonal bases of wavelets, multi resolution analysis, smoothness of wavelets, compactly supported wavelets, cardinal spline wavelets. Tensor products of wavelets, Decomposition and reconstruction algorithms for wavelets, wavelet packets, recent development and applications.

MTL781 Finite Element Theory and Applications

3 Credits (3-0-0)

Pre-requisite(s): MTL107/MTL509 and MTL411/MTL602

Variational formulation of elliptic boundary value problems; Lax Milgram Lemma; Existence and uniqueness of solutions; equivalence of Galerkin and Ritz variational formulations; Triangulation of ordinary domains-rectangles, polygons, circles, ellipses, etc. Finite element problems; conforming and non-conforming methods, Ce'a's Lemma, Interpolation on simplexes in R^n , different Lagrange and Hermite finite elements, Affine, isoparametric, sub-parametric, super parametric finite elements; Triangulation using isoparametric mapping; approximation of boundary; Numerical Integration, construction of element stiffness matrices and assembly into global stiffness matrix, Skyline method of solution of finite element equations; Solution of model problems and computer implementation procedures; Asymptotic error estimate results; Eigenvalue problems of Laplace operator.

MTL785 Natural Language Processing

3 Credits (3-0-0)

Overlaps with: COL772

Linguistic Essentials: Parts of speech and morphology, inflectional versus derivational morphology, Phrase structure and link grammar, Syntax and syntactic theory, Semantics - semantic annotations, semantic similarity, Syntactic and semantic Ambiguity, Anaphora and cataphora - resolution. Study of Words: Frequency N-grams, Word alignment in parallel corpora - length based, word based, cognate based, Word Sense Disambiguation - Supervised, unsupervised Techniques, Grammar: Markov Models, POS tagging, Context Free Grammar, Parsing - Example-based parsing, Study of Divergence, Applications: Machine Translation - Example Based, Rule Based, Statistical, Summarization - Word Space Model, Random Indexing, Multi Document summarization, Information Retrieval - vector based, term distribution based, Sentiment Analysis.

MTV791 Special Module in Dynamical System

1 Credit (1-0-0)

Basics - minimality, equicontinuity, recurrence, distality. Interplay of dynamical properties. Ergodicity. Symbolic dynamics. Relations arising from dynamical transformations and their Ellis semigroups. Entropy. Structure theorems. Decomposition theorems.

MTL792 Modern Methods in Partial Differential equations

3 Credits (3-0-0)

Pre-requisite(s): MTL411/MTL602

Review of Lebesgue integration and Classical function spaces, Spaces of infinitely differentiable functions and Holder spaces. Sobolev spaces: L^p spaces, Weak derivatives, Sobolev spaces, approximation to identity, approximation with smooth functions, trace spaces, Sobolev and Poincare inequalities, compact embeddings and negative order Sobolev spaces. Second order elliptic equations: Weak solutions, Lax-Milgram Theorem, Energy estimates, Fredholm-alternative, Regularity of weak solutions, Maximum principles and eigenvalue problems. Mountain Pass lemma and applications. Hardy's inequalities and their relation with Elliptic equations. Linear Evolution equations: Second order parabolic equations, existence and regularity of weak solutions, Maximum principles. Semi-group Theory: Generating, contraction semi-groups and applications.

MTL793 Numerical Methods for Hyperbolic PDEs

3 Credits (3-0-0)

Scalar conservation laws: Method of characteristics, Shocks, Rarefactions, weak and entropy solutions, existence and uniqueness results, Finite volume schemes, Riemann solvers, Convergence of first order schemes. Higher-order schemes: Lax-Wendroff, TVD schemes, Limiters, ENO schemes, Higher order Runge-Kutta methods. Linear systems: Exact solutions, First- and higher-order finite volume schemes. Non-linear Systems: Solutions of Riemann problems, First-Order finite volume schemes for systems. Higher-order schemes for systems: TVD Limiters. Finite-volume schemes on unstructured meshes. Hyperbolic systems with source term.

MTL794 Advanced Probability Theory

3 Credits (3-0-0)

Notions of Stochastic Convergence and Related Convergence Theorems, Uniform Integrability, Weak and Strong Laws of Large Numbers, Speed of Convergence in the Strong Laws of Large Numbers, Martingales, Processes, Filtrations, Stopping Times, Discrete Stochastic Integral, Martingale Convergence Theorems and Their Applications, Levy's Continuity Theorem and Various Versions of Central Limit Theorem, Markov Chains, Discrete Markov Chains, Convergence of Markov Chains, Applications of Probability Theory to Fourier Series-Examples.

MTL795 Numerical Method for Partial Differential Equations

4 Credits (3-1-0)

Two point boundary value problem: Variational approach, Discretization and convergence of numerical schemes. Second order Elliptic boundary value problem, Variational formulation and Boundary conditions, Finite element Methods, Galerkin Discretization, Implementation, Finite difference and Finite volume methods, Convergence and Accuracy.

Parabolic initial value problems, Heat equations, variational formulation, Method of lines, Convergence.

Wave Equations, Method of lines, Timestepping.

MTL796 Stochastic Differential Equations and Its Applications

3 Credits (3-0-0)

Mathematical construction of Brownian motion and its essential properties, Derivation of Itô-integrals and Itô calculus, Weak and strong solution concepts of SDEs, existence and uniqueness theorems for SDEs, Basic properties of Itô diffusions e.g., Markov, strong Markov

property, The generator of a diffusion processes, Dynkin's formula; Applications to boundary value problem (Kolmogorov's Backward equation, Feynman-Kac-formula), Optimal stopping (Optimal stopping problems involving an integral, Connection with variational inequalities), Control theory (Hamilton-Jacobi-Bellman Equation, Stochastic control problem with terminal conditions, Existence of optimal control, Stochastic maximum principle) and Mathematical finance (Option pricing).

MTL797 Computational Methods for Finance

3 Credits (3-0-0)

Risk Neutral probability. Review of option pricing. Deterministic, local and stochastic volatility models. Pricing characteristic of European, American and other options. Introduction to Finite difference methods. Finite Difference methods for European option pricing. Finite Difference methods for Asian, American and Barrier type contracts. Introduction to Advanced Numerical Methods, Advanced Numerical methods for European, American and other contracts. Pricing under local and stochastic volatility in Black-Scholes markets.

MTL799 Mathematical Analysis in Learning Theory

3 Credits (3-0-0)

Pre-requisite(s): 90 earned credits at the UG level

Overlap(s) with: COL341, ELL409, ELL784, COL774, ELL888

Review: Normed linear space, Banach space, Hilbert space, Orthonormal basis, Projection theorem, Dual spaces, Riesz representation theorem, Bounded linear operations, compact operators, Spectral theorem for self-adjoint compact operators.

Reproducing Kernel Hilbert Space (RKHS), Positive definite functions, Feature maps, Gaussian Kernel and their RKHSs, Mercer's theorem, The elements of statistical learning theory, Probabilistic inequalities, Tikhonov-type regularization, General regularization in Hilbert space, Representer theorem, Convergence analysis of empirical risk minimization, Adaptive regularization parameter choice rules.

Approximation by trigonometric polynomials, Localized kernel approximations, Neural Networks, RBF neural networks, universal approximation, Convergence analysis of neural networks, universal approximation, convergence analysis of neural networks, Analysis of Deep vs Shallow, University of deep convolution neural networks, Generative adversarial nets and convergence analysis.

MTL843 Mathematical Modeling of Credit Risk

3 Credits (3-0-0)

Pre-requisite(s): MTL106/MTL601

Review of elementary stochastic calculus and Black - Scholes - Merton theory of option pricing. Corporate liabilities and contingent claims. Risk structure of interest rates. Statistical techniques for analyzing defaults. Credit scoring modeling using logistic regression, Discriminant Analysis and support vector machines. Rating based term structure models. Credit risk and interest rate swaps. Credit default swaps (CDS), collateralized debt obligations (CDO's) and other related products. The copula approach. Portfolio Credit risk analysis using coherent risk measures.

MTL 850 Abstract Harmonic Analysis

3 Credits (3-0-0)

Fourier transform of L1 functions on \mathbb{R}^n , Fourier- Stieltjes transform, Plancherel theorem, convolution on L1 on \mathbb{R}^n , Fourier series of L1 functions on \mathbb{T}^n , Fourier- Stieltjes series, Plancherel theorem, convolution on L1 on \mathbb{T}^n .

Banach algebras, spectrum of an element and its properties, spectral radius, ideals in a commutative Banach algebra, spectrum of a commutative Banach algebra, Gelfand transform, Gelfand-Naimark theorem.

Topological groups and its properties, Haar measure on a locally compact group, existence and uniqueness, modulator function, convolution, homogeneous spaces, existence of an invariant measure, weil's formula.

Unitary representation of locally compact groups, Schur's lemma, relation between unitary representation of groups and the *-representations of the group algebra, positive definite functions, Gelfand-Raikov theorem.

Harmonic analysis of LCA groups: Dual group of locally compact abelian group, dual group as a locally compact abelian group, Pontriagin duality theorem, spectrum of the L1 space w.r.t. the convolution, Fourier analysis on locally compact abelian groups, Plancherel theorem, Bochner's theorem.

Harmonic analysis on compact groups: Finite dimensionality of the irreducible unitary representations of a compact group, Schur's orthogonality relations, Peter-Weyl theorem, Fourier analysis on compact groups, Plancherel theorem, representations of $SU(2)$ and $SO(3)$.

MTL851 Applied Numerical Analysis

3 Credits (3-0-0)

Error analysis and stability of algorithms. Nonlinear equations: Newton Raphson method, Muller's method, criterion for acceptance of a root, system of non-linear equations. Roots of polynomial equations. Linear system of algebraic equations : Gauss elimination method, LU-decomposition method; matrix inversion, iterative methods, ill- conditioned systems. Eigenvalue problems : Jacobi, Given's and Householder's methods for symmetric matrices, Rutishauser method for general matrices, Power and inverse power methods. Interpolation and approximation : Newton's, Lagrange and Hermite interpolating polynomials, cubic splines; least square and minimax approximations. Numerical differentiation and integration: Newton-Cotes and Gaussian type quadrature methods.

Ordinary differential equations : Initial value problems: single step and multistep methods, stability and their convergence. Boundary value problems: Shooting and difference methods.

Partial Differential Equations : Difference methods for solution of parabolic and hyperbolic equations in one and two-space dimensions, stability and their convergence, difference methods for elliptic equations.

MTL854 Interpolation and Approximation

3 Credits (3-0-0)

Interpolation : general problem, representation theorems, remainder theory, convergence of interpolatory processes. Approximation : best, uniform and least-squares, degree of approximation. Approximation of linear functionals : Optimal approximations in Hilbert spaces, roots and extremals : Convergence of Newton's method in Banach spaces, minimizing functionals on normed linear spaces, applications to integral equations and control theory.

Splines : applications to computer-aided design.

Filters : linear, least-squares and Chebyshev.

Applications to signal processing.

MTL855 Multiple Decision Procedures in Ranking and Selection

3 Credits (3-0-0)

The problem of ranking and selection, different approaches to the solution of problem. Indifference zone formulation : Ranking normal population in terms of means single and two stage procedures. Ranking normal population in terms of variances. Ranking binomial population-fixed sample size and multistage procedures, play the winner rules and vector at a time sampling. Ranking Gamma population with largest (smallest) scale parameter. Optimal properties of fixed subset size procedures Bayes, minimax and admissibilities properties, subset selection formulation : Decision theoretical formulation, best invariant rules. Restricted subset selection. Subset selection of normal population w.r.t. means and variances, selection of t-best. Subset selection in binomial and gamma populations. Comparison of population with a control. Normal and exponential populations.

MTL856 Lie Algebras

3 Credits (3-0-0)

Overlaps with: MTL756

Definitions and examples. Basic concepts. Solvable and Nilpotent Lie algebras, The Engel's theorem, Lie's theorem, Cartan's criterion, Killing form, Finite dimensional semi-simple Lie algebras and their representation theory. The Weyl's theorem. Representations of $sl(2, \mathbb{C})$. Root space decomposition. Rationality properties. Root systems, The Weyl group. Isomorphism and conjugacy theorems (Cartan subalgebras, Borel subalgebras). Universal enveloping algebras, PBW theorem, Serre's theorem. Representation theory and characters. Formulas of Weyl, Kostant and Steinberg. Introduction to infinite dimensional Lie algebras.

MTL860 Linear Algebra

3 Credits (3-0-0)

Vector spaces, linear transformations, Eigenvalues and eigenvectors, Diagonalization, Simultaneous triangulation and diagonalization. The primary decomposition theorem. Cyclic decomposition and the rational and Jordan canonical forms. Computation of invariant factors. Inner product spaces, unitary operators, spectral theorem for normal operators, polar decomposition. Bilinear and quadratic forms, Symmetric and Skew-symmetric bilinear forms. Non-negative matrices, Perron-Frobenius theory, generalized inverse of a matrix.

MTL863 Algebraic Number Theory

3 Credits (3-0-0)

Algebraic number fields, cyclotomic fields, quadratic and cubic fields, integral extensions, conjugate elements and conjugate fields, norms and traces. The discriminant. Noetherian rings and Dedekind domains. Finiteness of the class group. Dirichlet's unit theorem and its applications.

MTL874 Analysis

3 Credits (3-0-0)

Review of Banach and Hilbert spaces. The Hahn-Banach, Open mapping and Banach-Steinhaus theorems. The Riesz representation theorem, the spaces $L^p(0,1)$ and $L^2(0,1)$ Spectral theory and Sturm-Liouville systems, fixed point theory. The theorems by Banach, Browder and Schauder and applications. Picard's theorem. Integral equation of Fredholm, Volterra and Hammerstein. Nonlinear operators: The complementarity problem and its uses. Banach algebras and C^* algebras. Best approximation in normed linear spaces.

MTL882 Applied Analysis

3 Credits (3-0-0)

Review of Normed Linear spaces, Banach spaces and Hilbert spaces. Weak and weak* convergence, Spectrum of Bounded Linear operators. Browder and Schauder fixed point theorems and applications to Differential and integral equations, L^p spaces.

Distributions and Fourier transforms: Schwartz space, tempered distributions, Fourier transform of tempered distributions, Fourier transform of L^p functions and applications.

Sobolev spaces: Density, embedding and extension theorems.

Differential Calculus: Derivatives of maps on Banach spaces, inverse and implicit function theorems, Direct methods of Calculus of variations and applications.

MTL883 Physical Fluid Mechanics

3 Credits (3-0-0)

Description of principles of flow phenomena : pipe and channel flow laminar flow, transition, turbulence; flow past an object; boundary layer, wake, separation, vortices, drag, convection in horizontal layers, transition from periodic to chaotic behaviour; equations of motion; dynamical scaling, sample viscous flows; inviscid flows. Flow in rotating fluids; hydrodynamic stability.

MTL888 Boundary Elements Methods with Computer Implementation

3 Credits (3-0-0)

Distributions and Sobolev spaces of fractional order. Elliptic boundary value problems on unbounded domains in \mathbb{R}^n ($n=2,3$).

Fundamental solution of elliptic equations.

Simple layer and double layer potentials Fredholm integral equations of first and second kinds. Singular and hypersingular kernels.

Interior and exterior Dirichlet problems and integral representations of their solutions.

Variational formulation of problems defined on boundary. Solution of some model problems by boundary element methods, approximate integrations over boundary, solution methods of algebraic equations; computer implementation of boundary element methods for a model problem. Coupling of boundary element and finite element methods.

Some advanced topics of boundary integral methods integrals with hypersingular kernel, a method of elimination of singularity, Lagrange multiplier method.

Department of Mechanical Engineering

MCP100 Introduction to Engineering Visualization

2 Credits (0-0-4)

Sketching of engineering objects and interpretation of drawings as a visualisation and communication tool. Creating 3D components through the use of a CAD package. Simple assemblies, generation of assembly views from part drawings, animation of simple assemblies.

MCP101 Product Realization through Manufacturing

2 Credits (0-0-4)

Exposing role of manufacturing processes in product realization; Understanding product realization by endeavouring hands on activities; Experience of product realization by undertaking manufacturing exercises and assembly activity in teams.

MCL111 Kinematics and Dynamics of Machines

4 Credits (3-0-2)

Pre-requisite(s): APL100

Kinematic pairs, Kinematic diagram and inversions. Mobility and range of movements. Displacement, velocity and acceleration analysis of planar linkages, graphical and analytical methods. Dimensional synthesis for motion, function and path generation. Force analysis of planar mechanisms. Cam profile synthesis, graphical and analytical method. Gear tooth profile, interference in gears. Gear types, gear trains including compound epicyclic gears. Design of flywheel and governors. Inertia forces and their balancing for rotating and reciprocating machines.

Free and forced vibration of SDOF system. Introduction to 2 DOF systems, vibration absorbers.

MCL131 Manufacturing Processes-I

3 Credits (3-0-0)

Pre-requisite(s): MCP101

Overlaps with: With three core courses of ME2 (30% each)

CASTING: Sand casting, Gating system and its design, Riser design and its placement, Melting, Pouring and Fluidity, Solidification of pure metals and alloys, Casting defects, Inspection and testing. Other casting processes, advantages and applications.

WELDING: Shielded metal arc welding, other arc welding processes like TIG, MIG and SAW processes, Types of metal transfer in arc welding, Gas welding and Gas cutting, Resistance welding, Solid state welding processes, Brazing, Soldering and their applications, Surfacing and its applications.

FORMING: Plastic deformation of metals, stress-strain relationships, Yield criteria, Hot working and Cold working, Friction and lubrication in metal working, Analysis of bulk forming and sheet metal forming processes. Unconventional forming processes.

Powder : Powder production methods, compaction and sintering. Applications of powder metallurgy.

MCL132 Metal Forming and Press Tools

3 Credits (3-0-0)

Pre-requisite(s): MCP101

Overlaps with: 30% with MCL131

Mechanical behaviour of metals and alloys in plastic deformation, Stress-strain relationships, Yield criteria, Fundamentals of plasticity, Tensile properties, Flow stress and flow curves, Fundamentals of metal forming processes, Strain rate and temperature in metal working, Hot working, Cold working and annealing, Analysis of forming processes like forging, rolling, extrusion, wire drawing and sheet metal forming by slab method, Equipment and tools used in metal forming operations, Types of presses, different types of dies and their design aspects, Unconventional forming processes.

MCL133 Near Net Shape Manufacturing

3 Credits (3-0-0)

Pre-requisite(s): MCP101

Introduction and fundamentals of Casting of complicated shapes:

automotive components, casting of light alloys – Aluminum, Magnesium and Titanium alloys.

Injection moulding: Thermoplastics, thermoset plastics and composites – processing methodologies.

Powder Metallurgy: fabrication routes, powder size determination – micro and nano level, powder consolidation routes, compacting, sintering, hot pressing, sintering, hot iso static pressing, field assisted sintering technologies.

Advances in near net shape manufacturing: Metal Injection moulding, Laser engineered net shaping.

MCL134 Metrology and Quality Assurance

3.5 Credits (3-0-1)

Pre-requisite(s): MCP101

Overlaps with: MCL231

Introduction to Metrology and its relevance, standardization, dimensional measurement, limits, fits and tolerances, limit gauging, linear and angular measurements and their applications, surface roughness-quantification & measurement, Feature Inspection, Online inspection, Calibration.

Introduction to Quality Assurance and Quality Control, Various elements in Quality Assurance, On-line and Off-line quality control, Statistical concepts in quality, Central limit theorem, Quality Characteristics, QC Tools. Process capability studies, Remedial/Corrective actions.

Design of sampling plans, Economics of product inspection, Quality costs, Problems and illustrations in Quality Assurance.

MCL135 Welding and Allied Processes

3 Credits (3-0-0)

Pre-requisite(s): MCP101

Principles of arc welding, basic physics of arc and flame, Gas welding and Gas cutting, manual metal arc welding, GTAW, GMAW. Metal transfer mechanisms in arc welding, Weld bead characterization, Electrode and electrodeless welding, Resistance welding, Heat flow characteristics and metallurgical changes in fusion welding, Solid state welding processes, Radiant energy welding processes, Brazing, Soldering and their applications, Joint design, welding symbols and Joint evaluation through destructive and non destructive testing methods, welding defects, causes and remedies, residual stress and distortion. Plasma cutting, surfacing and plasma spray forming, surfacing applications. Advances in welding.

MCL136 Material Removal Processes

3 Credits (3-0-0)

Pre-requisite(s): MCP101

Introduction to various material removal processes, Nomenclature and geometry of cutting tools, Mechanics of Conventional and Non Conventional Machining including force, temperature, surface integrity. Methods of measurement of forces, temperature and surface finish (experimentally and analytically), Tool wear mechanisms and tool life criteria, Basic concepts of cost and economics of machining.

Various types of machine tools and their structures, Workholding and tool holding devices for machine tools.

Ultraprecision machining and grinding methods and the machine tools used for such processes. Manufacturing of micro tools, Nano-finishing of materials using advanced machining methods.

MCL140 Engineering Thermodynamics

4 Credits (3-1-0)

Introduction: microscopic and macroscopic points of view. Basic concepts and definitions – system, boundary, equilibrium, steady state, zeroth law, temperature scale. Work and heat – definition and applications; various forms of work. Thermodynamic properties of a pure substance – saturated and other states, real gases, compressibility chart. The First Law of Thermodynamics for control mass/ volume, Internal Energy, Enthalpy, The SSSF and USUF Processes. Second Law – corollaries, Carnot cycle. Clausius inequality, entropy. Irreversibility and exergy analysis. Thermodynamic Relations. Vapor power cycles – Rankine cycle and its modifications.

Brayton/ Otto/ Dual cycles. Vapor compression refrigeration cycle. Thermodynamics of non-reacting mixtures, psychrometry.

MCL141 Thermal Science for Manufacturing

4 Credits (3-1-0)

Overlaps with: MCL140, MCL242 (50%), CLL110 (50%)

Overview and the importance of the knowledge of thermal science in manufacturing processes. Basics of thermodynamics: closed and open systems, work and heat. First law of thermodynamics for control mass and control volume. Second law of thermodynamics. Irreversibilities and examples of irreversibilities in manufacturing.

Introduction to transport phenomena : various modes of transport of momentum, energy and mass- diffusion and advective transport. Convective heat and mass transfer - Concept of momentum, thermal and concentration boundary layers; relevant correlations. Radiation heat transfer. Blackbody radiation. Gray and diffuse surfaces. Surface radiation. Case studies of manufacturing processes involving application of the above concepts.

MCL142 Thermal Science for Electrical Engineers

3 Credits (3-0-0)

Overlaps with: MCL140, MCL141, CLL121

Introduction to applications. Basic concepts and definitions – system, boundary, equilibrium, steady state and others. Thermodynamic properties of a pure substance – saturated and other states. Work and heat – definition and applications. 1st Law – internal energy and enthalpy, applications to non-flow/closed and flow/open systems (SSSF and USUF). 2nd Law – corollaries, Clausius inequality, entropy. Carnot cycle. Basics of gas-vapor mixtures. Vapor power cycles – Rankine cycle and its modifications. Steam generation and its use – power plants, co-generation, combined cycles. Introduction to various equipment in thermal power plant.

Introduction to transport phenomena: various modes of transport of momentum and energy - diffusion and advective transport. Modes of heat transfer in various applications. Conduction: Heat diffusion equation, 1-D steady state conduction in extended surfaces, infinite and semi-infinite walls, heat generation, lumped capacitance. Convection: Forced and free convection - mass, momentum and energy conservation equations, non-dimensional numbers, hydrodynamic and thermal boundary layers, basics of heat transfer in external and internal laminar and turbulent flows, and use of correlations. Radiation: properties, Laws, 3-surface network for diffuse-gray surfaces. Familiarization with heat exchangers. Application area example: cooling of electronics.

MCL201 Mechanical Engineering Drawing

3.5 Credits (2-0-3)

Pre-requisite(s): MCP100

Introduction to generation of drawings as a design process for machine assembly. Use of datum planes to locate features and machine elements uniquely in assemblies.

Sectioning, dimensioning, notes and version control in drawings.

Standardized representation of threads, fasteners, welds, bearings, springs and related components.

Introduction to limits, fits and tolerances, dimensional and geometric tolerances, surface finish symbols.

Generation of assembly drawings including sectioning and bill of materials.

Evolving details of components from assembly considerations. Detailing of components involving shafts, bearing, pulleys, gears, belts, brackets for assembly.

Solid modeling of above assembly and incorporating assembly constraints for animation of motion of machine assemblies.

MCL211 Design of Machines

4 Credits (3-0-2)

Pre-requisite(s): APL104, MCL100, MCL201

Conceptualization of a machine in terms of geometrical requirements specified in terms of functional degrees of freedom, degrees of constraints and stiffness. Synthesis of an assembly from machine

components to meet the functional requirements. Sizing machine components and selecting material through use of free body diagrams, failure theories in static and repeated loading. Design and selection of certain machine elements (i.e. cams, gears, belt-pulleys, bearings, springs, shaft/axle, plates, nuts and bolts, brake/clutch) as exemplars. Case studies (like Gearbox driven by motor using belt drive) through use of parametric software to carry out iteration in the design space.

MCL212 Control theory and applications

4 Credits (3-0-2)

Pre-requisite(s): MTL100, MTL101

Overlaps with: 50-60% with ELL225 and CLL261

Introduction; Fourier and Laplace transforms; Mathematical Modeling of simple physical systems; Transfer function; Block diagrams; Signal flow graph; Transient response analysis using Laplace transform; Frequency response; Design/performance specifications in time and frequency domain; Steady state error and error constants;

Proportional, integral, derivative, PD and PID control; Sensors and actuators for temperature, pressure, flow and motion control systems; Realization of standard controllers using hydraulic, pneumatic, electronic, electro-hydraulic and electro-pneumatic systems;

Stability; Routh's criterion; Nyquist stability criterion, Bode plots; Control system design using Root Locus and Frequency response; Lead and lag compensation; Gain margin, Phase margin; Introduction to Modern control: State space representation; Control with state feedback; Review of applications of control in: Machine tools, Aerospace, Boiler, Engine Governing, Active vibration control.

MCL231 Manufacturing Processes-II

3 Credits (3-0-0)

Pre-requisite(s): MCL131

Overlaps with: MCL134, MCL136

Introduction to Metal Machining and Machine Tools, Geometry of cutting tools, Mechanics of Machining including force and temperature generation, Methods of measurement of forces and temperature (experimentally and analytically), Tool wear mechanisms and tool life criteria, Basic concepts of cost and economics of machining.

Various types of machine tools and their development with regard to productivity & accuracy requirements, Workholding and tool holding devices for machine tools.

Introduction to non-conventional machining processes and understanding basic mechanisms of material removal in such processes. Introduction to metrology, Dimensional Inspection, Inspection by measurement, Limit gauging, Design of Limit gauges, Surface quality inspection, Feature inspection.

MCP231 Manufacturing Laboratory-I

1 Credit (0-0-2)

Pre-requisite(s): MCL131

Overlaps with: MCP232 (60%)

Experiments on casting, joining, forming, injection molding and powder metallurgical processes.

MCP232 Production Engineering Laboratory-I

1 Credit (0-0-2)

Pre-requisite(s): MCL132, MCL133, MCL134

Overlaps with: MCP231 (60%)

Experiments on casting, forming, injection molding and powder metallurgical processes.

MCL241 Energy Systems and Technologies

4 Credits (3-0.5-1)

Pre-requisite(s): MCL140

Overlaps with: ESL714 (>50%)

Energy sources :

Fuels : Fossil fuels, Nuclear fuels, Direct Solar, Indirect solar - Biomass, Ocean, Tidal, Hydro, Wind etc. Energy demand/ Growth/ economics; Fuel upgradation: gasification of coal and biomass; biogas.

Energy conversion: Direct Conversion: Solar PV, Fuel Cells, Thermoelectric Conversion. Thermal to electric: IC Engines, Gas and Steam Turbines; Electromechanical conversion; Hydraulic turbines. Chemical to Thermal: Combustion and stoichiometry.

Energy utilization : Refrigeration, HVAC, Desalination, Polygeneration; pumps and compressors.

Energy storage : Thermal/Mechanical/Electric/Chemical.

Environmental Impact : Air/water/soil/nuclear waste.

MCL242 Heat and Mass Transfer

4 Credits (3-1-0)

Pre-requisite(s): MCL140 & APL106

Overlaps with: CLL251

Modes of heat transfer, energy carriers and continuum approximation. Mechanisms of mass transfer. Unified view of momentum, heat and mass transfer.

Conduction: Fourier's law, heat diffusion equation, 1-D steady state conduction in extended surfaces, heat generation, lumped capacitance and 1D transient models, semi-infinite wall. Diffusion mass transfer in 1D: steady state and transient.

Convection: Forced and free convection - mass, momentum and energy conservation equations, scaling analysis and significance of non-dimensional numbers, thermal boundary layers, heat transfer in external and internal laminar and turbulent flows, and use of correlations. Convective mass transfer. Boiling and condensation: physical phenomena and correlations.

Heat exchanger types and analysis: LMTD and effectiveness-NTU method.

Radiation: properties, Laws, view factor, 3-surface network for diffuse-gray surfaces. Gas radiation.

MCL261 Introduction to Operations Research

3 Credits (3-0-0)

Pre-requisite(s): MTL108

Introduction to Modeling, Linear Programming - Formulation, Solution methods including Simplex, Primal-Dual, Integer Programming-Formulation, Solution methods, Introduction to Dynamic Programming, Software Tools and Case Studies.

MCP261 Industrial Engineering Laboratory-I

1 Credit (0-0-2)

Pre-requisite(s): MCL261, MCL262

Deterministic optimization problem formulation, solution using CPLEX, sensitivity analysis; Conceptualization/Visualization of problem situation, formulation of simulation model, simulation runs and output analysis.

MCL262 Stochastic Modelling and Simulation

3 Credits (3-0-0)

Pre-requisite(s): MTL108

Overview of Probability Basics, Introduction to Discrete Time Markov Chains (DTMC), Transient and Limiting analysis of DTMC, Introduction to Continuous Time Markov Chains (CTMC), Transient and Limiting analysis of DTMC, Applications, Discrete Event Simulation - Introduction, Generation of Random Variables, Simulation modeling through case studies.

MCP301 Mechanical Engineering Laboratory-I

1.5 Credits (0-0-3)

Pre-requisite(s): APL104, APL106, MCL111, MCL140, MCL241

Experiments pertaining to applications of the concepts learnt in the theory courses of Fluid Mech, Solid Mech, Thermodynamics, Kinematics and dynamics and Energy Systems.

MCL311 CAD and Finite Element Analysis

4 Credits (3-0-2)

Pre-requisite(s): APL104, MCL211

Overlaps with: AML705, 706, 710 (course should be mutually exclusive w.r.t these courses)

Introduction and overview. Need and Scope of Computer Aided Machine Design. Role of Geometric Modelling, FE and Optimization; 2D and 3D Geometric transformations and projections. The Viewing pipeline; Geometric modeling; Modelling of curves, cubics, splines, beziers and b-splines, NURBS; Modeling of surfaces; Modeling of solids-b-rep, CSG, octree, feature based modeling; Introduction to the Finite Element Method, principle of potential energy; 1D elements, Derivation of Stiffness and Mass matrices for a bar, a beam and a shaft, FEA using 2D and 3D elements; Plain strain and plain stress problems, plates/shell elements; Importance of Finite element mesh, Automatic meshing techniques; Interfacing with CAD software.

Introduction to Thermal analysis, Dynamic analysis using eigen values, and Non linear analysis; Limitations of FEM.

MCL314 Acoustics and Noise Control

4 Credits (3-0-2)

Pre-requisite(s): APL100

Overlaps with: MEL733 (20%), MEL746 (50%), ITL 760 (60%)

Fundamentals of acoustics, Reflection and transmission of waves, Sound sources and generation mechanisms, Human physiological response to noise, Sound measurement, Sound in enclosed spaces, Sound absorption, Acoustic enclosures and barriers, Sound propagation in ducts, Vibration control, Active noise control, Overview of Numerical acoustics.

MCL321 Automotive Systems

4 Credits (3-0-2)

Overlaps with: MEL311 (10%),

Review of basic engine management systems, alternative fuel systems, fuel ignition systems, hybrid electric vehicles, exhaust emission systems, drivetrain systems, chassis, environmental management and service information systems. Introduction of torque converters, planetary gears, clutches, differentials, all-wheel drive, heating and air conditioning systems, and interaction of tyre and road interface. History of engine technology. Detail of starting and charging systems. Details of steering and suspension systems. Details of bearing and lubrication systems.

MCL322 Power Train Design

3 Credits (3-0-0)

Pre-requisite(s): MCL211

Overlaps with: MEL311 (10%)

Introduction of components of automotive powertrain system, viz., engines, transmission, clutches and brakes. Engine characteristics. Throttle system, Turbochargers, History and design of valve train. Design of variable valve timing system, Exhaust gas recirculation. Materials in powertrain components. Lubrication systems to minimize life cycle costs. Modelling and design of gearbox. Role of control system in advanced (i.e. direct injection, active boosting, camless) powertrain system.

MCL330 Special Topics Production Engineering

3 Credits (3-0-0)

Pre-requisite(s): To be defined by the course coordinator at the time of offering the course if required

Specialized topics in Production Engineering. The detailed contents will be decided by the faculty who will reach the course.

MCL331 Micro and Nano Manufacturing

3 Credits (3-0-0)

Pre-requisite(s): for ME1: MCL131, MCL231 for ME2: MCL136
An overview of micro and nano mechanical systems and their

applications in Mechanical Engineering, MEMS Microfabrication methods, Silicon Micromachining methods, Laser, Electron and Ion beam micromachining methods, Mechanical Micromachining techniques, Nanomanufacturing methods, nanomaterials and nano metrology.

MCP331 Manufacturing Laboratory-II

1 Credit (0-0-2)

Pre-requisite(s): for ME1: MCL131, MCL231 for ME2: MCL136 Experiments on machining and metrology.

MCP332 Production Engineering Laboratory-II

1 Credit (0-0-2)

Pre-requisite(s): MCL135, MCL136, MCP232 Experiments on machining and welding processes.

MCL334 Industrial Automation

4 Credits (3-0-2)

Pre-requisite(s): ELL101 and APL106 or MCL141

Overlaps with: 5% with MEL312

Introduction to Automation technologies, applications around us and in manufacturing. Types of systems - mechanical, electrical, electronics; Sensors, Factory Automation Sensors, Electrical sensors, Process Automation Sensors and their interfaces; Hydraulics & Pneumatic Systems and components; Circuit design approach and examples; Sequence operation of more than two cylinders and motors; Electro Pneumatic & Electro Hydraulic Systems, Relay Logic circuits, Feedback control systems; Programmable Logic Controllers, programming languages & instruction set, ladder logic, functional blocks, structured text, and applications. Human Machine Interface & SCADA; Motion controller, stepper & servo motors, multi axes coordinated motion, CNC control; RFID technology and its application; Machine vision and control applications.

Laboratory work will be hands-on design and operation of automatic systems.

MCL336 Advances in Welding

4 Credits (3-0-2)

Pre-requisite(s): MCL131 or MCL135

Introduction to joining technology, General survey and classification of Welding processes, importance of advanced materials and joining technologies, welding technologies related to industries: automotive, aerospace, nuclear, oil and gas industries.

MCL337 Advanced Machining Processes

3 Credits (3-0-0)

Prerequisites: MCL231 or MCL136

Overlaps with: ~20% overlap with MCL231 and MCL136

Introduction to advanced machining processes – need for such processes and application areas.

Mechanical Energy utilized advanced machining processes like ultrasonic machining, abrasive flow machining, magnetic abrasive finishing, magneto-rheological finishing, abrasive water jet machining–mechanics of cutting, process parametric analysis, process capabilities, applications.

Thermoelectric based advanced machining processes like electro discharge machining, wire EDM, Plasma Arc Machining, Laser Beam Machining, Focussed Ion Beam Machining – working principles, material removal mechanisms, process capabilities and applications.

Electrochemical and Chemical Advanced Machining – ECG, Electrostream Drilling, Chemical Machining – process characteristics, numerical modelling of the processes, applications and limitations.

MCL338 Mechatronic Applications in Manufacturing

4 Credits (3-0-2)

Pre-requisite(s): ELL101

Overlaps with: MEL749, EEL482

Introduction to mechatronic systems and components, Review of manufacturing and need and integration of mechatronics at different levels, Principles of basic electronics, Digital electronics review: number system, gates, flip-flops, counters, registers, tri-state concept, TTL and CMOS circuits, memories. Embedded electronics, Basics of Microcontroller & Microprocessors architecture and instruction set, machine cycles, interrupts, instruction set, memory and I/O interfacing, programming techniques, Timer/ Counters, Serial Interfacing and communications, Interfacing to keyboards and displays, Standard busses. Microcontrollers and their applications, integrated circuits, sensors, actuators, and other electrical/electronic hardware in mechatronic systems. Microprocessor based measurement and control: D/A and A/D conversion, data acquisition systems, encoders, interfacing of motors and transducers. Selection of mechatronic components, namely sensors like encoders and resolvers. Stepper and servomotors; Solenoid like actuators; Transmission elements like Ball screw and Controllers. Analysis of mechatronic systems with applications to motion control, robotics, CNC systems, and others. Case studies of applications in process and discrete manufacturing.

Laboratory work will be hands-on Microcontroller & Microprocessor interfacing and programming, Motion controller, motors, sensors, and actuators.

MCL341 Gas Dynamics and Propulsion

4 Credits (3-0-2)

Pre-requisite(s): MCL140 & MCL241

Revision of fundamentals. Thermodynamics of compressible flow – wave motion in compressible medium, Mach number and cone, properties. Steady one-dimensional compressible flow through variable area ducts. Converging and converging-diverging nozzles and diffusers. Effects of heating and friction in duct flow, Rayleigh and Fanno lines. Flows with normal shocks. Oblique shocks and reflection. Expansion waves. Prandtl-Meyer flow. Flow over bodies. Measurements and applications. Jet propulsion – types of engines, propulsion fundamentals. Compressor, combustor and turbines construction and performance. Rocket propulsion – basics, solid and liquid propelled engines, parametric studies, construction features, single and multi-stage rockets. Thrust chamber and nozzle models. Studies of in-use engines. Environmental aspects.

MCL343 Introduction to Combustion

3 Credits (3-0-0)

Pre-requisite(s): (MCL140 and MCL242) or MCL141

Introduction. Fuels: gaseous, liquid and solid. Physical and chemical characterizations. Chemical thermodynamics and kinetics. Conservation equations for multi-component systems. Premixed systems: laminar flame problems and effects of different variables. Measurement of flame speed. Flammability limits. Ignition and quenching. Turbulent premixed flames. Non-premixed systems: laminar diffusion flamejet, droplet burning. Combustion of solids: drying, devolatilization and char combustion. Biomass combustion devices. Coal combustion. Pollution: Main pollutants and their environmental impact. NO_x, CO and SO_x formation chemistry. Particulate pollutants. Emissions from engines, power plants and industrial applications. Low NO_x burners and furnace design.

MCL344 Refrigeration and Air-conditioning

4 Credits (3-0-2)

Pre-requisite(s): (MCL140 and MCL242) or MCL141

Overlaps with: ESL850

Introduction and applications, recapitulation of fundamentals. Vapor compression systems: Ideal and real cycle analyses, Refrigerants: designation, desirable properties, environmental considerations. Advanced vapor compression cycles. Components: condensers, evaporators, compressors and expansion devices – construction, operation and performance. Vapor absorption and gas cycle refrigeration. Psychrometry. Processes - heating, humidification, cooling and dehumidification etc. Air-conditioning calculations, Cooling load estimation.

MCL345 Reciprocating Internal Combustion Engines

4 Credits (3-0-2)

*Pre-requisite(s): MCL140 or MCL141**Overlaps with: <10% with PG I.C. Engine course*

Introduction, Engine design and operating parameters, Ideal properties, Models of engine processes and cycles, combustion thermodynamics, fuel/air cycle analysis, Spark-Ignition engine combustion, SI and Diesel engine emissions, IC Engines: the future.

MCL347 Intermediate Heat Transfer

3 Credits (3-0-0)

*Pre-requisite(s): MTL100, MTL101, MCL242**Overlaps with: MCL441 (~20%)*

Heat conduction: Governing equation, Analytical solution of steady and unsteady 2D heat conduction, Heat transfer from convective radiative fins; Convection: Governing equations, Forced convection heat transfer, scale analysis, similarity solutions and momentum integral method for laminar flows, energy integral method for turbulent flows; Natural convection: similarity solutions and energy integral methods, mixed convection; Heat transfer from pipes: analytical solutions; Heat transfer at high speed; Radiative heat transfer: blackbody radiation, radiative heat transfer between gray, diffusive surfaces, radiative heat exchange between non-gray surfaces, gas radiation, enclosure theory, governing equation for radiatively participating medium. Boiling: pool boiling, development of a correlation for nucleate boiling, critical heat flux, flow boiling. Condensation: film condensation over flat and circular geometries, Nusselt theory.

MCL348 Thermal Management of Electronics

3 Credits (3-0-0)

Pre-requisite(s): APL106 and (MCL242 or MCL141)

Electronics packaging and cooling technologies; Heat sinks: principle, types, modelling, and design; Contact resistance; Heat pipes and two phase systems: principle, types, modelling and design; Microchannel heat exchangers: single phase and two phase; Radiative heat transfer and importance in space applications; Thermoelectric devices; Measurement and characterisation techniques; Case studies of thermal management of electronics.

MCL350 Mechanical Engineering Product Synthesis

2 Credits (1-0-2)

Pre-requisite(s): Product-related core courses, as specified by the instructor

Study of product specifications, GA drawings, sub-systems and component functionalities. Component-wise study of engineering design, including, material selection, stress analysis, fluid flow analysis, heat transfer analysis, etc. Implications of geometrical dimensioning and tolerancing. Materials and manufacturing processes. Assembly. Wear, performance deterioration and failure. Testing and certification. Failure modes and effects analysis. Modifications and their implications. Regulatory requirements. Standards.

MCL361 Manufacturing System Design

3 Credits (3-0-0)

Pre-requisite(s): MTL108, MCL261

Manufacturing strategy, Manufacturing flexibility, Manufacturing complexity, Investment decisions using life cycle costing, System reliability and maintenance models, Economic design of quality control plans, Single and mixed model assembly line balancing, Shop floor scheduling algorithms, Lot sizing and inventory control models, Performance modeling of manufacturing systems, Production control mechanisms like Kanban, CONWIP and POL2.

MCP361 Industrial Engineering Laboratory-II

1 Credit (0-0-2)

Pre-requisite(s): MCP261, MCL361

Design of optimal acceptance sampling plans, Design of optimal control charts, Simulation of process failures, Simulation of machine

failures and Simulation of job shops and production lines with various production control mechanisms.

MCL363 Investment Planning

3 Credits (3-0-0)

Pre-requisite(s): MCL261 & MCL262

Introduction to investment and rate of return, Markowitz theory and its applications to optimal portfolio management, Introduction to Bonds, Introduction to Derivatives and Options, Concept of Risk Neutral Pricing, Single period and multiple period binomial models for option pricing, Introduction to Black Scholes model and the formula.

MCL364 Value Engineering

4 Credits (3-0-2)

Overlaps with: MEL671

Introduction to Value Engineering and Value Analysis, Methodology of V.E., Quantitative definition of value, Use value and prestige value, Estimation of product quality/performance, Classification of functions, functional cost and functional worth, Effect of value improvement on profitability. Introduction to V.E. job plan / Functional approach to value improvement, Various phases and techniques of the job plan, Life Cycle Costing for managing the total value of a product, Cash flow diagrams, Concepts in LCC, Present Value concept, Annuity cost concept, Net Present Value, Pay Back period, Internal rate of return on investment (IRR), Continuous discounting, Examples and illustrations. Creative thinking and creative judgment, False material, labor and overhead saving, System reliability, Reliability elements in series and in parallel, Decision Matrix, Evaluation of value alternatives, Estimation of weights and efficiencies, Sensitivity analysis, Utility transformation functions, Fast diagramming, Critical path of functions, DARSIRI method of value analysis.

MCL366 OR Methods in Policy and Governance

3 Credits (3-0-0)

Pre-requisite(s): MCL261

Mixed Integer Linear Programming, Markov Decision Processes, Applications of OR techniques to areas such as aviation security, resource allocation, energy policy, railways systems, management of natural resources, Public Service Delivery.

MCL368 Quality and Reliability Engineering

3 Credits (3-0-0)

Pre-requisite(s): MTL108

Process capability analysis, Process quality improvement approaches, Economics of quality control, Reliability data analysis, Component and system reliability models, Reliability test plans, Warranty analysis, Maintenance models.

MCL370 Special Topics in Industrial Engineering

3 Credits (3-0-0)

Pre-requisite(s): To be defined by the course coordinator at the time of offering the course if required

Specialized topics in Industrial Engineering. The detailed contents will be decided by the faculty who will teach the course.

MCL380 Special Topics in Mechanical Engineering

3 Credits (3-0-0)

Pre-requisite(s): courses as specified by the instructor and EC 50

Course details shall be announced at the time of offering of the course. The assessment will be based on a combination of assignments, quizzes, and term paper and tests.

MCV390 Refrigeration and Air Conditioning Product Design

1 Credit (1-0-0)

Pre-requisite(s): Thermodynamics, Heat Transfer, Energy Conversion

Develop a context for new product design. The course begins with a fundamental understanding of an ideal system and the opportunities for improvement in real life systems. Overview of air conditioning system components and their selection criteria. Integration of these components into a product design using case studies of indigenously developed products for Indian Railways and Telecom industry. The course will enable students to look at what goes into preparing a comprehensive input for a new design and the process used to validate the design from prototype to commercial production.

MCP401 Mechanical Engineering Laboratory-II

2 Credits (0-0-4)

Pre-requisite(s): MCL211, MCL212, MCL242, MCP301

The experiments would involve full or partial fabrication of setups and then taking readings and analysis of its behavior, instead of using ready made setups. The knowledge gained in control engineering course would also be used for setting up computerised measurements using Data acquisition cards.

MCD411 B.Tech. Project-I

4 Credits (0-0-8)

Pre-requisite(s): EC 100

A broad outline of the contents is as follows and a project may include some or all of these activities:

Team formation for designing, manufacturing and operating a selected product, formulating project management procedures. Need identification, assessment of alternative designs, selection of design for development, defining design and performance specifications, and testing procedure. Detailed mechanical, thermal and manufacturing-related design of systems, assemblies, sub-assemblies and components culminating in engineering drawings and material specifications; preparing bill of materials and identification of standard components and bought-out parts.

Using engineering drawings, the process sheets are developed based on available materials, machine tools and other fabrication facilities. Materials and standard components are procured and manufacturing is carried out. After inspection, parts are accepted. Assembly procedure is finalized and the machine is assembled. Acceptance tests are carried out vis-à-vis specifications. Professional quality documentation of all designs, data, drawings, and results, change history, overall assessment, etc. is mandatory, along with a final presentation.

MCD412 B.Tech. Project-II

7 Credits (0-0-14)

Pre-requisite(s): EC 100

MCL421 Automotive Structural Design

3 Credits (2-0-2)

Pre-requisite(s): MCL211, MCL321

Overlaps with: MEL736 (40% - Students should be allowed to do only one of the two courses)

History of automotive design, Design cycle for an Automobile, Styling, Loads on the chassis, Chassis and structural Design for static loads, Dynamic and impact loads, Energy absorption in the vehicle, Designing for NVH, Designing the suspension system, Designing the brake system.

MCL422 Design of Brake Systems

3 Credits (2-0-2)

Pre-requisite(s): APL104, MCL111, MCL321

Types of brakes, Friction materials in brakes and their characteristics, Design of brakes in passenger cars/vans: weight transfer, effect of tyre/road adhesion, wheel lock, brake efficiency/adhesion utilization; Design of brakes in vehicle – trailer combinations: in light trailers, overrun brakes, center axle trailer, chassis trailer; Brake-design analysis: Brake and shoe factors in different types of brakes, Comparison of estimation by analytical and FE methods; Thermal

effects in friction brakes (thermal analysis and heat dissipation); Issues in electronic control of brakes: features of anti-lock brake system, Traction Control System, Electronic Stability Control, Adaptive Cruise Control, trailer Sway Control; Brake Noise: Sources, its analysis (using analytical and FE based approaches) and control.

MCL431 CAM and Automation

3 Credits (2-0-2)

Pre-requisite(s): for ME1: MCL131, MCL231

for ME2: MCL136

Automation need and types of automation, economics of automation, FMS, CIM. Basics of electro-mechanical automation technologies, Circuit design and applications of hydraulic, pneumatic, electro-pneumatic, electro-hydraulic and programmable logic control (PLC) systems. Numerical control, NC and CNC hardware and programming, Machine controls, HMI design and implementation, DNC system, Control engineering in production systems: open loop and closed loop control systems, Automated material handling technologies, Group technology, Computer aided process planning, Inspection automation and reverse engineering, Rapid prototyping and tooling concepts and applications, virtual manufacturing.

MCL441 Modelling and Experiments in Heat Transfer

4 Credits (2-0-4)

Pre-requisite(s): (MCL242 or MCL141) and MCP301

Modelling heat transfer phenomena, comparison with experimental data, assumptions and their implications. Mathematical modeling: dimensional analysis, scaling, physical similarity, self-similarity, physical laws and constitutive relations. Solution methodologies: separation of variables, self-similar solutions, boundary layer analysis. Results: representation and interpretation, uncertainty and error bands. Heat transfer experiments: design, uncertainty analysis, selection of geometrical and physical parameters, instrumentation, and rig calibration. Temperature, pressure and flow rate measurements. Systemic errors in temperature measurement: thermocouples and thermowell. Data acquisition systems: basics and applications. Data analysis and error estimation. Project-type work involving modeling, designing and performing experiments related to heat transfer applications.

MCL442 Thermofluid Analysis of Biosystems

3 Credits (3-0-0)

Pre-requisite(s): APL106 and [(MCL140 & MCL242) or MCL141] and EC 80

Applications of fluid mechanics, heat transfer, and thermodynamics to biological processes, including blood flow in the circulatory system, heart function, effects of heating and cooling on cells, tissues, and proteins.

MCL443 Electrochemical Energy Systems

3 Credits (3-0-0)

Pre-requisite(s): MCL140 & MCL242 or MCL141 and EC 80

Overlaps with: CLL722 (30%), CLL720 (10%), CLL721 (15%)
Introduction to electrochemical systems – electrochemical power sources, nomenclature, survey of common types. Thermodynamics – thermodynamic functions, chemical and electrochemical potentials, temperature dependence, activity dependence. Reaction kinetics – electrical double layer, kinetics, activation energy of reactions, current-voltage relationship, polarization and losses, charge transfer kinetics, performance criteria. Transport processes – infinitely dilute solutions, concentrated solutions, thermal effects, fluid mechanics. Modeling of electrochemical systems – governing equations, assumptions, boundary conditions of species and charge. Thermal management. Environmental impact.

MCL701 Advanced Thermodynamics

3 Credits (3-0-0)

Review of basic fundamentals, closed system and open system

formulations, laws of thermodynamics, the maximum entropy principle, concept of equations of state, ideal gas, van der Waals equations and other variants, compressibility, maximum work theorem, exergy, energy minimum principle, thermodynamic potentials and relationships for compressible, elastic, electric and magnetic systems, stability conditions of potentials, multicomponent systems, entropy of mixing, chemical potential, mixtures, conditions of equilibrium and stability of multicomponent systems, thermodynamics of reactive mixtures.

MCL702 Advanced Fluid Mechanics

3 Credits (3-0-0)

Formulation of Navier-Stokes equations. Exact solutions of the Navier-Stokes equations for select unsteady/steady flows, potential flows, boundary layer theory and its applications, turbulent flows; special topics in fluid mechanics such as capillary and electrokinetic flows.

MCL703 Advanced Heat and Mass Transfer

3 Credits (3-0-0)

Derivation of governing equation for three dimensional transient heat conduction problems. Two-dimensional steady state heat conduction. Transient one-dimensional heat conduction in finite length bodies. Diffusive Mass Transfer – Fick's law and governing equation. Melting and solidification.

Newton's law of cooling-Derivation of energy equation- Self-similar solution for laminar boundary flow over a flat plate – energy integral method for laminar boundary layer flow over a flat surface-Laminar internal flows-thermally fully developed flows-Graetz problem - Natural convection over a vertical flat plate: similarity solutions and energy integral method- natural convection in enclosures-mixed convection-Turbulent flow and heat transfer: Reynolds averaged equations-Turbulent boundary layer flows – The law of wall-integral solutions. Convective mass transfer.

Convection with phase change: Pool boiling regimes- Condensation: drop-wise condensation-Laminar film condensation over a vertical surface.

Radiative heat transfer: Black body radiation-radiative properties of non-black bodies-surface radiation heat transfer in enclosures with gray diffused walls and non-gray surfaces.

MCL704 Applied Mathematics for Thermofluids

3 Credits (3-0-0)

Initial-boundary value problems, Linear and Non-linear systems; Theory of linear homogeneous and nonhomogeneous equations; Non-linear systems; Series solutions of linear ordinary differential equations; special functions; 1st order PDEs, classification of PDEs: 2nd order PDE - Planar, cylindrical and spherical geometries, Homogeneous and non homogeneous PDEs, Sturm-Liouville theory; Stability and instability of regular system.

MCL705 Experimental Methods

4 Credits (3-0-2)

Methodology and planning of experimental work and reporting results. Types of errors, uncertainty propagation and statistical basis of uncertainty. Statics and data interpretation: population and sample, mean and standard deviation, standard deviation of mean, probability distributions and sample size selection. Design of experiments. Instruments: specifications, characteristics, and sources of error. Data acquisition and signal processing: analog to digital conversion, Fourier series and transform, sampling, aliasing, and filtering. Cross-correlation and autocorrelation. Digital image analysis.

MCL721 Automotive Prime Movers

3 Credits (3-0-0)

Introduction to current technologies, Design and Performance analysis of MPFI-SI and CRDI-CI engines. Advanced thermodynamic modeling of near DI-SI and HCCI-DI engines. Analysis of five stroke and six stroke cycles for SI and CI engines. Design of Electric and Hydraulic Prime Movers. Concept, classification and analysis of Hybrid Prime mover systems.

MCL722 Mechanical Design of Prime Mover Elements

3 Credits (3-0-0)

Introduction of prime-movers. Introduction of transmission-systems, clutches and brakes. Engine Characteristics. Throttle system, Turbochargers, History of valve train. Design of valve train. Design of variable valve timing system, flywheel. Material selection. Lubrication systems to minimize the maintenance requirement. Modelling and design of gearbox. Role of control system in advanced (i.e. direct injection, active boosting, camless) powertrain system

MCL723 Vehicle Dynamics

3 Credits (2-0-2)

Basics of Modeling: Euler Angles, Vehicle fixed and Earth fixed coordinate systems. Application of Newton's second law. Role of inertia. Vehicle Traction: Engine Performance Curves, Traction curves, Loads on grades, Aerodynamic resistance, ideal gear shifting positions, Rolling Resistance, Transverse weight shift due to accelerations, maximum acceleration, Traction limits.

Braking Dynamics: Tire road friction, braking efficiency, wheel lock up, wheel skidding, performance with anti-lock brake systems.

Vehicle Vibrations: Measures of Ride quality, predictions of vibrations, suspension stiffness and damping, road roughness models, response to speed breakers, Heave, pitch and roll phenomenon of dynamic Motion, quarter car, half car and full car model, Seat suspension, relation to human body vibrations.

Steering Dynamics: Steering system moments and forces, FWD,RWD and 4WD steering systems, understeer and over steer, roll steer, Tire cornering forces, slip angle, critical speed, roll stability, steering of heavy vehicles, steering dynamics of tractor trailer systems.

Role of Suspensions in Vehicle Dynamics: Independent Suspensions, and Solid axles, roll center analysis important class of suspensions, roll over stability of vehicles on suspensions.

MCL724 Biomechanics in Trauma and Automotive Design

3 Credits (3-0-0)

Introduction to Biomechanics of human body esp. its Musculo -skeletal systems. Biomechanics (including injury indices) of the Head, Neck, Thorax and Lower Extremity, Crashworthiness standards-crash tests and crash simulations, Human Body Models for analysis-Lumped mass, multi body, FE and integrated models, modeling of contact, modeling of muscles, belts, modeling of airbags and other safety devices. Human Anthropometry, Crash Dummies and Dummy models, Goals of crashworthiness in automotive design. Design of the automotive chassis for crashworthiness, Different aspects of crashworthiness-designing for frontal, side impact, rear impact, rollover and pedestrian/2 wheeler impacts, The future-current trends in automotive crashworthiness.

MCL725 Design Electronic Assist Systems in Automobiles

3 Credits (3-0-0)

Introduction to Automotive Electrical and Electronic Systems, Electric and Electronic components, Instrumentation: Gauges and sensors, Introduction to body computer: Microprocessor, Antilock braking system: the mechanism and control implementation, Power steering, Suspension, Air conditioning: controls and implementation, Accessories: Intelligent windshield wipers, Power door locks, Power windows, Power seats, Vehicle audio entertainment system, Navigation system, airbags and belt tensioners.

MCL726 Design of Steering Systems

3 Credits (3-0-0)

Introduction of steering requirements and system; steady-state cornering – slip angle effects, steady-state turns, calculating steady-state steering characteristics, lateral weight transfer effect, traction effect, neutral steer point and static margin, swing axle; steady-state cornering – steer effects, roll effects, wheel control, understeer and oversteer effects, torque steer, lateral deflection steer, straight running, suspension geometry effects, effect of road surface, wind handling; transient cornering, steering when moving forward, steering when moving reverse, boat steering and truck in reverse; examples of steering system; conclusion.

MCL728 Nanotribology*3 Credits (3-0-0)*

Topics will include surface force and adhesion models for soft and hard solids; friction laws for nano, micro and macro contacts; atomic-scale stick-slip phenomenon; the roles of surface energy and surface forces on friction and wear; molecular structure effects on friction; nano-lubrication and design of nano-lubricants (self-assembled monolayers, ultra-thin films of functionalized polymers); nano-texturing and surface roughness effects; surface chemisorptions and physisorption effects; friction-induced effects such as wear, molecular alignments, tribo-charging, surface oxidation, third-body generation etc. The above principles would be applied to modern technologies such as data storage (head-disk interface) tribology, various micromachines such as micro-electromechanical systems (MEMS) tribology and nature's solutions to tribological problems through a few case studies.

MCL729 Nanomechanics*3 Credits (2-0-2)*

Introduction to nanomechanics, need for studying nanomechanics, its scope and limitations; Dynamics of 2-atom, 3-atom molecules, and an N-atom chain; Crystal Lattice and Reciprocal Lattice; Dynamic Interaction Potentials and Periodic Boundary Conditions in molecular dynamics simulations; Role of different ensembles; Evaluation of atomic stresses and strains, Evaluation of Specific Heat, Dissipation of Energy in nano-mechanical Systems; Solutions for classical Nano scale structural components such as Carbon Nanotubes, Nano rods, Nanowires and Polymers; Correlations between Nano-mechanics and classical continuum theory of solids; Size effect; Introduction to multiscale modeling.

MCL730 Designing with advanced materials*4 Credits (3-0-2)*

Introduction to polymers, composites and smart materials. Polymer microstructure and mechanical properties. Thermosets and thermoplastics. Viscoelastic creep and relaxation behavior, mechanical models, and polymer failure. Design considerations and practices for polymeric components with case studies. Composite materials and their applications. Micro and macro mechanics of lamina, failure criteria of lamina, classical laminate theory, strength of laminates. Design considerations and practices for composite structures with case studies. Structure, applications and design considerations of smart materials such as shape memory alloys and piezoelectric materials.

MCL731 Analytical Dynamics*3 Credits (3-0-0)*

Review of Newtonian dynamics; Degrees of freedom; Generalized coordinates and constraints; Holonomic and nonholonomic systems; Principle of Virtual work; D'Alembert's principle; Euler-Lagrange equations of motion; Hamilton's principle; Rotating coordinate systems; Euler angles; Coordinate transformation; Kinematics of a rigid body; Euler's equations of rotation; Computer-oriented dynamic modeling; Orthogonal-complement based formulation of dynamic equations; Geometric theory; Stability; Lyapunov's direct method; Introduction to flexible-body dynamics.

MCL733 Vibration and Noise Engineering*3 Credits (3-0-0)*

Elements of vibration analysis: modeling practical systems through discrete system/lumped parameters approach and its subsequent analysis for different types of excitations encountered in practice. Alternate mathematical models of damping, two and multi-DOF systems, tuned mass dampers. Introduction to vibration isolation: displacement/force isolation, approaches for MDOF system analysis with emphasis on modal approach. Numerical and Continuum Analysis: Finite Element Method for dynamic analysis. Distributed parameter models of rods, bars, beams, membranes and plates. Introduction to Modal testing, Vibration Testing. Spatial, Modal and Response models of vibrating systems. Non-linear and Random vibrations: Introduction to non-linear vibrations, response to random excitation. Engineering acoustics: Wave approach to sound, wave equation, Noise measurement and instrumentation standards. Sound pressure, power and intensity and its measurement, Sound

Intensity, Various Sound Fields, Concept of Monopoles, Dipoles and Quadrupoles, Sound Power measurement, Transmission loss, Design of partitions, barriers, acoustic enclosures, Design of Mufflers; Sound Absorbing Materials, Noise Control approaches, case studies.

MCL735 CAD and Finite Element Analysis*4 Credits (3-0-2)*

Introduction and overview. Need and Scope of Computer Aided Machine Design. Role of Geometric Modelling, FE and Optimization; Introduction to the Finite Element Method, principles of minimization of potential energy: Rayleigh Ritz and Galerkin Methods, 1D elements and their analysis, analysis of bars, beams and trusses, axis-symmetric solids, 2D/3D solids, solution methods in FE, error analysis, Introduction to Dynamic and Non linear analysis; Limitations of FEM; 2D and 3D Geometric transformations, Orthographic and Perspective Projections. Euler angles, Windowing, view-porting and viewing transformations, Modeling of cubics, beziers, b-splines, NURBS and advanced curves; Modeling of surfaces: ruled surfaces, surfaces of revolution, Bicubic, Bezier, B-splines; Feature Based Modeling and Feature Recognition.

MCL736 Automotive Design*4 Credits (3-0-2)*

History of automotive design, Design cycle for an Automobile, Styling, Loads on the chassis, Chassis and structural Design for static loads, Dynamic and impact loads, Energy absorption in the vehicle, Computational tools for structural design, vehicle occupant system analysis, biomechanics of the human body and its implications for structural design, Designing for NVH, Designing the suspension system, Designing the brake system, Design of engine characteristics, Design requirements of the transmission and the driveline.

MCL738 Dynamics of Multibody Systems*3 Credits (2-0-2)*

Overview of kinematic descriptions of serial, tree, and closed-loop chains, Degrees of freedom, and Kinematic constraints of rigid and flexible systems; Basics of Euler-Lagrange and other classical dynamic formulations, and those with orthogonal complements; Dynamic algorithms (inverse and forward dynamics); Efficiency and numerical stability aspects of the algorithms; Introduction to commercial software like RecurDyn.

MCL740 Advanced Lubrication*4 Credits (3-0-2)*

Introduction: surface topography and its 2-D and 3-D characterizations, interactions of surfaces, friction, wear, lubrication; Regimes of lubrication: hydrodynamic, elastohydrodynamic, mixed, boundary, Stribeck curve; Lubricant: mineral oil, synthetic oil, grease, emulsions, gases, properties of lubricants, various rheology models; Derivation of governing equations: conservation of mass, momentum, energy, establishing 3-D Reynolds equation and energy equation for lubrication simulations; Cavitation and turbulence models; Contact mechanics: 2-D and 3-D contacts, surface and subsurface stresses, asperity contact models, elastic deformation at contacts; Applications of governing equations in design and performance analysis of journal bearings, thrust bearings, squeeze film bearings, hydrostatic bearings, rolling bearings, gear sets, seals, and piston rings; Lubrication in metal forming; Dynamic coefficients: stiffness and damping calculations, rotor vibrations, oil-whirl instability, and friction instabilities; Failure analysis of lubricated contacts/interfaces, Immersing technology: surface textures and bionic surfaces.

MCL741 Control*4 Credits (3-0-2)*

An introduction to control systems; transfer function representation of mechanical and mechatronic systems; stability analysis, gain setting for stability; transient and steady-state response analyses; control system analysis and design by the Root-Locus method and the Frequency-Response method; PID controllers design and realization; State-Space representation, controllability and observability; control system design in State Space; digital implementation of classical controllers.

MCL742 Design & Optimization

4 Credits (3-0-2)

Review of machine element design based on strength and distortion criterion; review of choice of materials and their treatment: Designing for fatigue, creep; Design criterion for fracture; Application of advanced design criterion to machine elements (like shafts, spur/bevel/worm gears); Design of structures, machines and equipment; Classical methods of unconstrained optimization (single variable and multi variable), classical methods of constrained optimization, Numerical optimisation techniques including i. genetic algorithms, (binary and real coded) ii. Simulated annealing. Case studies of Optimum Design (Gear Box, Power Transmission, shape and topology using FE).

MCL743 Plant Equipment Design

3 Credits (3-0-0)

Introduction to various kinds of plant equipment, and technological considerations in their design. Special considerations for typical industries such as petrochemicals, food-processing, power plants, and for mass production. Pressure vessel types and shapes. Design analysis of thin walled vessel for low pressure applications. Design analysis of thick walled vessels for high pressures and special applications. Vessel opening, closures and seals. Manufacturing considerations for pressure vessels. Configuration of various kinds of pumps used in process plants. Pump design considerations. Centrifugal pump selection. Design of pipes and piping joints, Layout of piping systems. Material Handling Equipment, Types and use. Design considerations for hoisting equipment, Surface and Overhead equipment Stackers and elevators, and conveyors. Design consideration in rotating machinery, bearing characteristics and selection, placement of critical speeds, effect of seals and foundation effects. Materials and manufacturing considerations in various plant equipment systems, and use of applicable standards, and available software packages.

MCL744 Design for Manufacture and Assembly

3 Credits (2-0-2)

Product design for life-cycle, concurrent engineering, dfx, design for manufacture, rule-based and plan based DFM, automated manufacturability assessment, Automated manufacturability assessment, Commonly used dfx tools including, QFD, POKA YOKE, FMEA, Design for manual assembly and automated assembly, design for environment, Industrial and real life case studies of dfx.

MCL745 Robotics

4 Credits (3-0-2)

Type and components of robots; Classification of closed- and open-loop kinematic systems; Definition of mechanisms and manipulators; Kinematic constraints; Degrees of freedom and mobility; Rotation representation; Coordinate transformation; DH parameters; Matrix methods for forward and inverse kinematics analyses; Jacobian and singularity; Dynamic modeling; Euler-Lagrange and Newton-Euler equations of motion for serial type manipulators; DeNOC-based dynamic formulation; Inverse and forward dynamics algorithms; Parallel robots; Inverse and forward kinematics of parallel robots; Gain singularity of parallel robots; Introduction to control of robotic systems.

MCL746 Design for Noise Vibration and Harshness

4 Credits (3-0-2)

Fundamentals of Vibrations and their manifestations in real life systems. Review of Design of a Vibration Absorber. Vibration Reduction Measures, Unconstrained and constrained layer damping treatment, add on dampers, and stiffeners. Changing the dynamic characteristics of a structure, Structural dynamics modification. Predicting the modification (dynamic design) Design of Isolators in machine foundations. Role of materials damping. Balancing of rotating machinery. Rigid and flexible rotor balancing. Active Vibrations control. Introduction of wave analysis of structures and spaces. , Characteristics of Duct and Cabin Noise. Stationary modes. Random noise. Measures of a sound acoustic design, importance of reverberations time. Various types of acoustic testing chambers. Noise

measurement and control instruments. Sound Intensity Mapping Noise isolation design. Noise absorber design. Design of silencers, mufflers. Acoustic Design of Buildings.

MCL747 Design of Precision Machines

3 Credits (2-0-2)

Pre-requisite(s): For UG:AML140, MCL111, MCL211

Fundamental concepts in precision design; design for stiffness; controlling Degrees-of-Freedom, exact-constrained design; design of elastic mechanisms/flexures/compliant mechanisms; friction, hysteresis and micro-slip; actuators and sensors for precision motion; materials selection in precision machine design; slideways for long range precision motion; and dynamics of precision mechanisms.

MCL748 Tribological Systems Design

4 Credits (3-0-2)

Lubrication, Friction and Wear aspects in Design; Tribological Surfaces – Measures of Roughness and associated mechanisms of Lubrication, Regimes of Lubrication; Boundary lubrication and lubricants. Friction and wear at different length scales. Viscosity - its representation and measurement, apparent viscosity. Selection of Bearings - Rubbing, Fluid Film, Rolling Element. Lubricants - Types and Selection, Bearing Design - Rubbing, Fluid Film Journal and Thrust, Dynamically Loaded, Rolling Element, Design of lubrication Systems. Introduction to maintenance of Bearings, Seals, Linear Bearing Design, Slideways. Material considerations for selected tribological applications.

MCL749 Mechatronic Product Design

4 Credits (3-0-2)

*Pre-requisite(s): For UG : ELL101, MCL338**Overlaps with: EEL482*

Introduction to key elements of Mechatronic products - Physical Systems Modeling, Sensors and Actuators, Signals and Systems, Computers and Logic Systems, Software and Data Acquisition; Mechatronic Design Approach, System Interfacing, Instrumentation and Control Systems; Microprocessor-Based Controllers and Microelectronics; Product functional block diagram, schematic and PCB Design, Product enclosure design, Microcontroller interfacing and programming, Interfacing with sensors and actuators, driver circuits, motion control, Stepper and servo motion control. Software and hardware tools to build mechatronic systems. Design and selection of mechatronic elements namely sensors like encoders and resolvers; stepper and servomotors, ballscrews, solenoid like actuators, and controllers with applications to CNC systems, robotics, consumer electronic products etc. Design of a mechatronic product using available software CAD packages.

Laboratory work will be hands-on Microcontroller & Microprocessor interfacing and programming, Motion controller, motors, sensors, and actuators.

MCL750 Product design and Manufacturing

3 Credits (1-0-4)

Product design for a given need or identified need, Development and evaluation of multiple solutions and concepts, Manufacturability assessments of given design, Product Costing and Bill of Materials, Process planning for components and assembly, Product manufacturing and Testing.

MCL751 Industrial Engineering Systems

3 Credits (1-0-4)

Overview of IE methods and tools such as decision making under uncertainty (Pay-off tables, decision trees, utility theory etc.), Probability based methods for outcome prediction (Logistic regression, Bayesian belief networks, Monte Carlo simulation etc.), Multicriteria decision making (AHP, ANP, Graph theory etc.), System Simulation (through games like the Beer game for supply chain), Queuing theory games, Economic analysis (NPV, IRR etc. for deterministic and stochastic scenarios), Algorithms (branch and bound, Metaheuristics etc.), Formulation of bigger optimization problems and solving using available solvers (eg. CPLEX). Shop-floor scheduling.

MCL753 Manufacturing Informatics

4 Credits (3-0-2)

Pre-requisite(s): MCL361

Introduction to manufacturing analytics (manufacturing analytics concepts, contemporary issues in high-value manufacturing, and opportunities provided by analytics and big data technologies), data types and applications (point of sale data, service touch point data, service centre data, warranty data, machine condition data, machine failure history, machine utilisation data, work in process data and online quality control data), optimisation of manufacturing processes (optimisation concepts, evolutionary computing, multi-objective optimisation, and applications of optimisation for sequential and assembly processes), and latest advancements in manufacturing analytics (virtual reality, augmented reality, and motion capture gaming technologies for manufacturing).

MCL754 Operations Planning and Control

3 Credits (3-0-0)

Evolution of Scientific Management and Buzzwords, Inventory Management and Control, MRP and ERP, JIT, Modeling of Processes and Systems, Measuring and Improving Performance, Scheduling, Aggregate Production Planning, Facility Location.

MCL755 Service System Design

3 Credits (2-0-2)

Pre-requisite(s): MTL108

Need for servitization, Service system types, Key dimensions of service systems, Frameworks for service system design, tools for service system design, Value co-creation, Service quality models, Economics of service systems, Service contract design, CMMI-SVC model for service systems, Case studies on service system design.

MCL756 Supply Chain Management

3 Credits (3-0-0)

Pre-requisite(s): MCL361

Supply Chain Orientation and Management, Various flows in a typical supply chain, Supply chain strategy – its context, components and structure, Location Decisions, Inventory Decisions, Information Decisions – Bull whip effect and its ramifications, remedies, Transportation Decisions - including planning techniques, Supply chain modeling and analysis, Performance measurement; Various frameworks including Balanced Score Card, SCOR etc., Customer Service level selection and supply chain vulnerabilities, Reverse Logistics and decision making involved, Supply chain integration and web enabled supply management.

MCL757 Logistics

3 Credits (3-0-0)

Logistics Management is the part of supply chain management that plans, implements, and controls the efficient, effective forward and reverse flow and storage of goods, services, and related information between the point of origin and the point of consumption in order to meet customers' requirements.

This course provides a practical, management perspective of the following areas of logistics: distribution, transportation, international logistics, inventory control, sustainable logistics practices, key performance indicators, supply chain finance, leadership in a supply chain role, and an introduction to logistics technology including RFID and ERP systems.

MCL758 OPTIMIZATION

3 Credits (3-0-0)

Optimization Theory in single and multiple dimensions, Karush-Kuhn-Tucker Conditions, Non Linear Programming, Solution Methods, Stochastic Programming, Applications and case studies.

MCL759 Entrepreneurship

3 Credits (3-0-0)

Ideation, Team Building, Making of a Business Plan, Securing Funding, Legal Procedures, Case studies of successful and failed attempts.

MCL760 Project Management

3 Credits (3-0-0)

Pre-requisite(s): MTL108

The nature of projects, the project as a non-repetitive unit production system, the project as an agent of change. Project Identification considering objectives and SWOT analysis, Screening of project ideas, Technical, Market, Financial, Socio-economic and Ecological Appraisal of a project. Work break down structure and network development. Basic Scheduling, Critical Path and four kinds of floats, Scheduling under probabilistic durations, Time Cost tradeoffs, Project Monitoring with PERT/Cost, Organizational aspects, Computer packages and project completion.

MCL761 Probability and Statistics

3 Credits (3-0-0)

Probability Laws, Random Variables, Conditional Probability and Bayes Theorem, Important Random Variables and their properties, Joint Probability Distributions, Law of Total Probability, Law of Large Numbers, Central Limit Theorem, Estimation Theory, Parameter Estimation, Hypothesis Testing using Parametric and Non-Parametric Methods, Goodness of fit tests, ANOVA, Linear Regression (Simple, Generalized) and Logistics Regression.

MCL765 Operations Research

3 Credits (3-0-0)

The art and science of modeling, Linear Programming, Solution methods including Simplex, Sensitivity Analysis, Shadow Pricing and Duality Theory, Integer Programming and Solution methods, Dynamic Programming with applications, Large Canonical problems such as Transportation Problem, Traveling Salesman Problem, Network Flow Problem, Case Studies.

MCL769 Metal Forming Analysis

4 Credits (3-0-2)

Revision of fundamentals of plastic deformation and metal forming, Constitutive equations for plastic deformation, effect of strain, strain rate and temperature, Theory of plasticity, Analysis of important bulk forming processes and sheet metal forming processes, Workability, Upper and lower bound methods, Slipline field theory, Defects in sheet metal forming, Introduction to FE analysis of forming processes.

MCL770 Stochastic Modeling and Simulation

3 Credits (3-0-0)

Overview of Probability Basics, Introduction to Discrete Time Markov Chains (DTMC), Transient and Limiting analysis of DTMC, Introduction to Continuous Time Markov Chains (CTMC), Transient and Limiting analysis of DTMC, Applications, Discrete Event Simulation - Introduction, Generation of Random Variables, Simulation modeling through case studies.

MCL771 Value Engineering and Life Cycle Costing

3 Credits (3-0-0)

Introduction to Value Engineering and Value Analysis, Methodology of V.E., Quantitative definition of use value and prestige value, Estimation of product quality/performance, Classification of Functions, Functional Cost and Functional Worth, Effect of value improvement on profitability. Introduction to V.E. Job plan / Functional Approach to Value Improvement, Various phases and techniques of the job plan. Life Cycle Costing for managing the Total Value of a Product, Cash flow diagrams, Concepts in LCC, Present Value concept, Annuity cost concept, Net Present Value, Pay Back period, Internal rate of return on investment (IRR), Continuous discounting, Examples and illustrations. Creative thinking and creative judgment, False savings, System Reliability, Evaluation Matrix, Assessment of value alternatives, Estimation of weights and efficiencies, Sensitivity analysis, Utility transformation functions, Fast diagramming, Critical path of functions, DARSIRI method of value analysis. Critical review of some industry oriented projects and case studies.

MCL772 Reliability Engineering

3 Credits (3-0-0)

Time to failure distributions; Parameter estimation for non-repairable systems; Reliability models for series, parallel and mixed configurations; Reliability models for active/passive redundancy, load sharing systems, mixed population, competing failure modes; Stress-Strength models; Conditional reliability models and residual life calculation; Reliability models for multiple operational phases; Shock based reliability models; Reliability models for non-repairable systems; Parameter estimation for repairable systems, Failure Mode and Effects Analysis, Fault Tree Analysis; Failure simulation; Warranty cost analysis; Reliability allocation; Reliability of production systems; Test plan design for non-accelerated life tests; Accelerated life testing models; Burn-in test plans.

MCL773 Quality Systems

3 Credits (3-0-0)

Introduction to quality systems through approaches proposed by Juran, Deming, Baldrige, Taguchi, Crosby etc., Quality costs, Requirements analysis using methods like Kano's analysis, Requirement mapping using QFD, Product and process analysis using Design and Process FMEA, Robust design and process improvement using online and offline methods for design and analysis of experiments, Shainin's tools for variability reduction, Process capability analysis and loss functions, Statistical tolerancing, Design of control charts and acceptance sampling plans, Quality standards like ISO 9000, ISO 14000, CMMI etc.; Service quality models and Service blueprints and Service FMEA, Case studies.

MCL775 Special Topics in Industrial Engineering

3 Credits (3-0-0)

To be decided by the instructor at the time of offering.

MCL776 Advances in Metal Forming

3 Credits (3-0-0)

Pre-requisite(s): For UG: MCL131 or MCL132; for PG MCL769
Advanced metal forming processes such as tube and sheet hydroforming, High energy rate forming processes such as EMF, EHF and explosive forming. Design of dies for forging, extrusion and wire drawing, Die design for sheet metal forming processes such as single and multi-stage deep drawing, bending and stretch forming. Materials used for making forming tools, Lubrication mechanisms, Metal forming equipment, Formability testing of sheet metals, Determination of Forming Limit Diagrams and their applications, Warm forming, Micro forming.

MCL777 Machine Tool Design

4 Credits (3-0-2)

Pre-requisite(s): MCL231 or MCL136

Course will cover machine tool design process which will include machine tool specifications, conceptual design, configuration design, mechanical structure design, design of drives & controls. Methods of achieving required mechanical accuracies considering static, dynamic and thermal loads, geometric, kinematic and thermal error compensation. Machine tool acceptance tests and characterization of machine tools for no-load and load conditions.

MCL778 Design and Metallurgy of Welded Joints

4 Credits (3-0-2)

Importance of welding in fabrication, Problems and difficulties in welded structures, service and fabrication tests and their importance, weld testing and qualification, causes and remedies for weld defects, weld symbols, weld joint design for strength and quality and automation in welding.

MCL780 Casting Technology

4 Credits (3-0-2)

Sand casting: sand molding techniques, Core sand and core fabrication.

Other casting: Permanent mold, pressure die casting, squeeze

casting, centrifugal casting, continuous casting, stir casting, defects and inspection.

Gating system, risering system, casting design: Metallurgical consideration, design consideration, economical consideration. Fluidity testing, Application of CAD\CAM in foundry.

Casting of complicated shapes: automotive components, casting of light alloys – Aluminum, magnesium and Titanium alloys.

Advances in near net shape manufacturing: Metal Injection moulding, Laser engineered net shaping.

MCL781 Machining Processes and Analysis

4 Credits (3-0-2)

Introduction to basic traditional machining processes – the need and requirements for such processes and their brief application areas.

Specifications and geometry of various cutting tools such as turning tools, drills, milling cutters in different referencing systems such as work reference, tool reference and machine reference systems.

Methods and techniques used for sharpening/resharpening of these cutting tools.

Mechanisms of chip formation by single point, drilling and milling tools. Different types of chips obtained during machining. Concept of effective rake angle during machining.

Mechanics of machining of single point cutting tool, drill and milling cutter – estimation of cutting forces using analytical models, Experimental methods and instruments used for cutting force determination during machining processes, essential design features of the dynamometers used for such measurement.

Heat transfer during machining processes, identification of the different sources of heat generation and development of suitable models for analytical estimation of the cutting temperature, Experimental methods used for estimating cutting temperature.

Use of cutting fluids in machining – purposes, proper selection and methods of application of such cutting fluids.

Advanced cutting tool materials and processes used for development of such tools.

Mechanics of cutting tool wear and development of models for assessing the tool life.

Economics of machining – identifying the major parameters in machining and their roles on cutting force, surface finish and cutting temperature, selection of optimal conditions of process parameters to reduce machining costs through suitable models.

Introduction to Grinding processes and understanding of the differences between machining and grinding.

Grinding for bulk material removal – creep feed grinding – fast feed grinding.

Superabrasive grinding wheels – both monolayer and multilayer, advantages of the monolayer wheel and its applications.

Grinding Geometry and Kinematics – contact length – measurement of contact length definition of active grits and methods used for estimating active grits, use of single grit experiments to develop models for estimating forces and specific energy requirement in grinding.

Wheel Conditioning – truing and dressing techniques and parameters – effect of dressing on grinding wheel parameters – dressing of super-abrasive wheels.

Temperature generation during grinding process and thermal modelling of the process.

Thermal damages in grinding – burning – oxidation – tempering – residual stresses – effect of residual stresses on job quality – measurement of residual stresses – introduction to X-ray diffractometry – XRD measurement of residual stress – application of Barkhausen Noise Technique in grinding.

Special Machining and grinding processes such as • Ductile Regime Grinding • Diamond Turning.

MCL782 Computational Methods

2 Credits (2-0-0)

Errors in numerical calculations and series approximations, Solution of

algebraic and transcendental equations, Interpolation of data, finite differences, Curve fitting, Numerical differentiation and integration, Matrices and linear system of equations, Numerical solution of ordinary differential and partial differential equations, Solution of integral equations, Numerical solution of important production engineering problems.

MCL783 Automation in Manufacturing

4 Credits (3-0-2)

Introduction to Automation of different manufacturing processes. Types of systems - mechanical, electrical, electronics; Data conversion devices, transducers, signal processing devices, relays, contactors and timers. Sensors and their interfaces; Hydraulics & Pneumatic Systems design and their application to manufacturing equipment; Sequence operation of hydraulic and pneumatic cylinders and motors; Electro Pneumatic & Electro Hydraulic Systems design, Relay Logic circuits, Feedback control systems, PID Controller; Drives and mechanisms of an automated system: stepper motors, servo drives. Ball screws, linear motion bearings, electronic camming and gearing, indexing mechanisms, tool magazines, and transfer systems. Programmable Logic Controllers, I/Os, system interfacing, ladder logic, functional blocks, structured text, and applications. Human Machine Interface & SCADA; Motion controller and their programming, PLCOpen Motion Control blocks, multi axes coordinated motion, CNC control; RFID technology and its application; Machine vision and control applications. Modular Production Systems – Distribution, Conveying, Pick & Place etc.

Laboratory work will be hands-on design and operation of automatic systems.

MCL784 Computer Aided Manufacturing

4 Credits (3-0-2)

An overview of Computer Aided Manufacturing. Use and Programming of Computer Controlled Machines such as CNC, 3D Printing, CMM, Robots etc. Constructional aspects of computer controlled machines. Geometric modeling and computational geometry for manufacturing. Product Life-cycle modeling. Virtual and Distributed Manufacturing.

MCL785 Advanced Machining Processes

3 Credits (3-0-0)

Introduction to advanced machining processes – need for such processes and application areas

Mechanical Energy utilized advanced machining processes like ultrasonic machining, abrasive flow machining, magnetic abrasive finishing, magneto-rheological finishing, abrasive water jet machining – mechanics of cutting, process parametric analysis, process capabilities, applications.

Thermoelectric based advanced machining processes like electro discharge machining, wire EDM, Plasma Arc Machining, Laser Beam Machining, Focussed Ion Beam Machining – working principles, material removal mechanisms, process capabilities and applications. Electrochemical and Chemical Advanced Machining – ECG, Electrostream Drilling, Chemical Machining – process characteristics, numerical modelling of the processes, applications and limitations.

MCL786 Metrology

3 Credits (2-0-2)

Introduction to Dimensional Metrology, standardization, interchangeability, selective assembly, Indian standard specifications, application of tolerances, Limit gauging- Taylor's principles of limit gauging, Design of Gauges, Inspection by measurement; interferometers. GD&T, Applications of Dimensional Inspection, Inspection of Surface Quality, Feature inspection- straightness, flatness, parallelism, squareness, circularity and roundness. Automated Dimensional Measurements: Introduction, Automatic Gauging, Automatic Measuring Machines for inspecting multiple work piece dimensions, Automatic Gauging Machine Part-Matching Functions, Coordinate Measuring Machines-Types, Probes, Accessories, Measurement, Computer supported Coordinate Measurements.

MCL787 Welding Science and Technology

4 Credits (3-0-2)

General survey and classification of welding processes, importance of advanced materials and joining technologies, weld arc physics, power sources and their characteristics, welding technologies related to industries: automotive, aerospace, nuclear, oil and gas industries.

MCL788 Surface Engineering

4 Credits (3-0-2)

Introduction to surface engineering – importance and scope of surface engineering, conventional surface engineering practices like pickling, grinding, buffing etc., surface engineering by material addition like electroplating, surface modification of ferrous and non-ferrous materials like nitriding, cyaniding, aluminizing etc.

Advanced surface engineering practices like laser assisted surface modification, electron beam assisted modification, spraying techniques like flame and plasma spraying, high velocity oxyfuel, cold spray techniques.

Sputter deposition processes, PVD and CVD methods of surface coatings, surface modification by ion implantation and ion beam mixing.

Characterisation of the engineered surface and coatings like thickness, porosity and adhesion of coatings, surface microscopy and spectroscopic analysis of the modified surfaces.

Functional coatings and their applications.

MCP790 Process Engineering

4 Credits (2-0-4)

Understanding relation between geometry, materials and manufacturing in relation to process planning. Design for Manufacture and Assembly, Product life-cycle considerations, Selection of raw material geometries, process selection, selection of manufacturing equipment, process sequencing, tooling, work holding and In-process inspection. Process Planning for Assembly & Inspection, Computer Aided Process Planning, Lean concepts in manufacturing.

MCL791 Processing and Mechanics of Composite Materials

4 Credits (3-0-2)

Introduction to matrix materials - polymers, metals and ceramics. Introduction to reinforcements – fibers, flakes, particulates: macro, micro and nano. Hand layup, tape layup, autoclave moulding, vacuum bag moulding, compression moulding, resin transfer moulding, reaction injection moulding, filament winding, pultrusion, braiding, and other manufacturing variants. Macromechanics of a lamina as a building block of a composite structure, stress-strain relation, strain –stress relation for anisotropic material, orthotropic materials, material property matrix estimation, micromechanics of a lamina, effect of fiber volume fraction on properties, failure theories of a lamina. Laminate analysis, failure of a laminate, design principles of tailor made material systems.

MCL792 Injection Molding and Mold Design

3 Credits (2-0-2)

Introduction to Injection molding fundamentals, flow of non-Newtonian fluids, flow of various polymer melts in a cavity, molding cycle, injection molding machine characteristics- injection unit design, clamping unit design, shrinkage, warpage, defect free product, Moldflow analysis – fundamentals of FE analysis for fill, cool, warp, stress, DOE, results interpretation. Mold design fundamentals, type of molds - two plate, three plate, feeding system – sprue, runner, gate design, ejection system - pin, sleeve, stripper plate, air ejection design. Moldings with undercuts – internal, external, threads, split cavity, split core designs. Advances in injection molding process- microcellular, gas assisted, insert, outsert, push-pull, multilive, vibration assisted, micro lamellar, lost core. Designing with plastics, applications and future research.

MCL796 Additive Manufacturing

4 Credits (3-0-2)

Review of solid modeling techniques with comparison.

Product development. Simultaneous Engineering and Additive Manufacturing(AM). Basic Principle of AM processes. Support structure in Additive Manufacturing. Containment and critical applications. Generation of the physical layer model. Classification of AM Processes. Virtual Prototyping. Tessellation (STL format) and tessellation algorithms. Defects in STL files and repairing algorithms. Slicing and various slicing procedures. Accuracy and Surface quality in Additive Manufacturing. Effect of part deposition orientation on accuracy, surface finish, build time, support structure, cost etc. Various Rapid tooling techniques. Introduction to Reverse Engineering. Reverse engineering and Additive Manufacturing.

MCD800 Professional Project Activity

3 Credits (0-0-6)

Project Work.

MCD810 Major Project Part-I (Thermal Engineering)

12 Credits (0-0-24)

MCD811 Major Project Part-I (Thermal Engineering)

6 Credits (0-0-12)

MCL811 Advanced Power Generation Systems

3 Credits (3-0-0)

General Introduction to current power generation technology and need for advances systems. Analysis of Advanced Ultra super-critical power plants, Organic Rankine Cycle based systems, Power systems using mixtures as working fluids. Sizing of components for the selected systems. Design of power systems for solar, biomass and geothermal sources. Thermo-fluid analysis of solar PV systems. Hybrid solar PV-thermal systems. Recent developments in hydro power systems.

MCD812 Major Project Part 2 (Thermal Engineering)

12 Credits (0-0-24)

MCL812 Combustion

3 Credits (3-0-0)

Introduction - importance of combustion. Chemical thermodynamics and chemical kinetics. Important chemical mechanisms. Coupling chemical and thermal analysis of reacting systems. Premixed systems: detonation and deflagration, laminar flames, burning velocity, flammability limits, quenching and ignition. Turbulent premixed flames. Non-premixed systems: laminar diffusion flame jet, droplet burning. Combustion of solids: drying, devolatilization and char combustion. Practical aspects of coal combustion, woodstove combustion.

MCL813 Computational Heat Transfer

4 Credits (3-0-2)

Mathematical Description of the Physical Phenomena- Governing equations—mass, momentum, energy, species, General form of the scalar transport equation, Elliptic, parabolic and hyperbolic equations. Discretization Methods- Introduction to finite difference and finite volume method, Consistency, stability and convergence.

Diffusion Equation- 1D-2D steady diffusion, Source terms, non-linearity, Boundary conditions, interface diffusion coefficient, Under-relaxation, Solution of linear equations (preliminary), Unsteady diffusion, Explicit, Implicit and Crank-Nicolson scheme.

Convection and Diffusion- Steady one-dimensional convection and diffusion, Upwind, exponential, hybrid, power, QUICK scheme, Two-dimensional convection-diffusion.

Flow Field Calculation- Incompressibility issues and pressure-velocity coupling, Primitive variable versus other methods, Vorticity-stream function formulation, Staggered grid, SIMPLE family of algorithms.

Radiative heat transfer - Computation of surface radiation using zone method, Solution of radiative transfer equation using discrete transfer, discrete ordinates and finite volume methods.

MCL814 Convective Heat Transfer

3 Credits (3-0-0)

Derivation of energy equation-Similarity solutions for laminar external flows-Laminar internal flows-Transition flow-Heat transfer in transition flow-Reynolds averaged equations of motion, Averaged energy equations-Turbulent flow and heat transfer over a flat plate-Turbulent flow and heat transfer in pipes and channels-Laminar and turbulent natural convection-laminar and turbulent mixed convection - Pool boiling : nucleate boiling-film boiling, flow boiling-condensation : dropwise condensation-film condensation Nusselt theory-Special topics-Convective heat transfer in rotating systems, Microscale convective heat transfer, Convective heat transfer with nano-fluids, Combined convection and radiation, Double diffusive convection.

MCL815 Fire Dynamics and Engineering

4 Credits (2-0-4)

Basics of Conservation equations, Turbulence, radiation and thermochemistry. Ignition of solids- Burning and heat release rates. Properties of fire plumes- buoyant plumes and interactions with surfaces. Turbulent diffusion flames- structure, modeling, soot formation and radiation effects. Toxic products. Fire chemistry, thermal decomposition of bulk fuel, pyrolysis, nitrogen and halogen chemistry. Fire growth- ignition, initial conditions, flame and fire spread theory, feedback to fuel. Compartment zone models. Flashover, post-flashover and control. Fire detection, suppression methods, codes, standards and laws. Case studies of real fires- buildings, transport, industries, shamiana and jhuggi-jhonpdi etc.

MCL816 Gas Dynamics

4 Credits (3-0-2)

Revision of fundamentals. Thermodynamics of compressible flow – wave motion in compressible medium, Mach number and cone, properties. Steady one-dimensional compressible flow through variable area ducts. Converging and converging-diverging nozzles and diffusers. Effects of heating and friction in duct flow, Rayleigh and Fanno lines. Flows with normal shocks. Oblique shocks and reflection. Expansion waves. Prandtl-Meyer flow. Flow over bodies. Measurements and applications. Jet propulsion – types of engines, propulsion fundamentals. Compressor, combustor and turbines construction and performance. Rocket propulsion – basics, solid and liquid propelled engines, parametric studies, construction features, single and multi-stage rockets. Thrust chamber and nozzle models. Studies of in-use engines. Environmental aspects.

MCL817 Heat Exchangers

3 Credits (3-0-0)

Applications. Basic design methodologies – LMTD and effectiveness-NTU methods. Overall heat transfer coefficient, fouling. Correlations for heat transfer coefficient and friction factor. Classification and types of heat exchangers and construction details. Design and rating of double pipe heat exchangers, shell and tube heat exchangers, compact heat exchangers, plate and heat pipe type, condensers, cooling towers. Heat exchanger standards and testing, Heat transfer enhancement and efficient surfaces.

MCL818 Heating, Ventilating and Air-conditioning

3 Credits (3-0-2)

Introduction, psychrometry of airconditioning processes. HVAC technologies. Thermal comfort - factors influencing thermal comfort. Cooling and Heating load calculations. Room air distribution principles. Design of air duct systems.

Indoor air quality. Ventilation - need, principles. Various types of air conditioning systems. Cooling, dehumidification and humidification equipment. Temperature, pressure and humidity controllers. Various types of controls and control strategies.

MCL819 Lattice Boltzmann method

3 Credits (3-0-0)

Introduction, Kinetic theory and statistical mechanics, Lattice gas cellular automata, LBM, Thermal LBM, Boundary conditions, Body forces, Multiple relaxation time model, Single component multiphase models, Multicomponent models single phase models, Applications of LBM.

MCL820 Micro/nano scale heat transfer

4 Credits (3-0-2)

Introduction to micro/nano scale transport phenomena, size effect behaviour, overview of engg. applications, fundamentals of micro/nano scale fluid mechanics and heat transfer – kinetic theory, quantum mechanics considerations, Boltzmann transport equation, molecular dynamics modelling, microfluidics - Knudsen number, slip theory, micro/nano scale heat conduction - classical/ quantum size effects, thermal conductivity models, specific heat, thin films, convection in microtubes and channels, nanoparticles and nanofluids – preparation & transport properties, microfluidics - electrokinetic flows, microscale radiative heat transfer – modelling, properties, measurements at microscale.

MCL821 Radiative Heat Transfer

3 Credits (3-0-0)

Introduction to Radiation- Recapitulation: Radiative properties of opaque surfaces, Intensity, emissive power, radiosity, Planck's law, Wien's displacement law, Black and Gray surfaces, View factors.

Enclosure with Transparent Medium- Enclosure analysis for diffuse-gray surfaces and non-diffuse, non-gray surfaces, net radiation method.

Radiative heat transfer in Participating Medium- Radiation in absorbing, emitting and scattering media. Absorption, scattering and extinction coefficients, Radiative transfer equation. Analytical solution of radiative transfer equation.

Introduction to different radiation model- Discrete transfer method, discrete ordinates method Radiation from particulate media, Dependent versus independent scattering Non-gray radiation, Modelling of non-gray radiation. Transient radiation and its solution. Radiative transfer in porous media. Combined Heat Transfer Modes- Radiation with conduction, combined boundary layer.

MCL822 Steam and Gas Turbines

4 Credits (3-0-2)

Introduction, Recapitulation of heat cycles of steam power plants and gas turbine engines, Thermodynamics and fluid dynamics of compressible flow through turbines, meanline analysis and design of axial flow turbines, Three dimensional flows in axial flow turbines, Partial admission turbines, Turbines for nuclear power plants, Steam turbines for co-generation, turbine for super critical thermal power plant, operation of turbine plants- start up and shut-down of a turbine, steady state operation.

MCL823 Thermal Design

4 Credits (3-0-2)

Introduction to design, modelling and simulation, components and systems. Component design. Design of heat sink - single fin optimization, multiple fin array. Design of compact heat exchangers - Fundamentals, shell and tube heat exchangers, plate heat exchangers, finned tube heat exchangers. Design of Heat pipe - Fundamentals, design procedure. Design of thermoelectric devices - Fundamentals, thermoelectric generator, thermoelectric cooler, module design.

System design:

Design of thermal systems: System identification and description with mathematical modelling: Examples with Power plant, refrigeration plant, HVAC systems, pump pipe network, electric space heaters, wind tunnel.

Development of a numerical model, mathematical techniques, solution of non-linear equations, numerical model for a system, system simulation, methods of numerical simulation.

Optimization - basic concepts, optimization of thermal systems, Lagrange multiplier, optimization of unconstrained problems, search based methods, Genetic algorithm, Differential Evolution method.

Thermal design based on inverse methods - Definition, estimation of boundary condition, conjugate gradient method.

MCL824 Turbocompressors

3 Credits (3-0-0)

Introduction, Fluid mechanics and thermodynamics of axial and radial flow compressors, operation and performance of compressors, compressor cascades, blade to blade flow for axial compressors with

subsonic inlet flow, blade-to-blade flow for axial flow compressors with supersonic inlet flow, loss correlations, performance analysis of axial flow compressors, Centrifugal compressor - the centrifugal impeller, diffuser of centrifugal compressor, stall and surge, supersonic compressors, compressor instrumentation and testing.

MCL825 Design of Wind Power Farms

4 Credits (3-0-2)

General Introduction to Wind Turbines, Analysis of wind source, 2-D Aerodynamics, 3-D Aerodynamics, Momentum Theory for an Ideal Wind Turbine, wind turbine performance, Design of HAWT, Design of VAWT, Component sizing, Analysis and design of wind farms, Optimal selection of layouts.

MCL826 Introduction to Microfluidics

4 Credits (3-0-2)

Pre-requisite(s): APL106 and MCL242 or their equivalents for UG students only

Micro- and nano-scale flow fundamentals: molecular basis of fluid mechanics and transport processes, scaling laws for microfluidics, microfabrication

Flows with low inertia: flow past bodies, lubrication theory, Hele Shaw flows, steady/unsteady parallel flows

Interfacial phenomena: wetting, capillary effects, super-hydrophobic surfaces, electro-wetting, thermo-/solute-capillary effects, hydrodynamic slippage in liquids, Internal flows in rarefied gas dynamics, Diffusion, unsteady convective mass transfer (Taylor-Aris dispersion), ion-transport in dilute solutions, absorption, mixing, thermal effects, electrical double layers and the Poisson-Boltzmann equation, Electrohydrodynamics in dilute electrolyte solutions

Electrokinetic transport phenomena: electro-osmosis and electrophoresis

MCS830 Independent Study

3 Credits (0-3-0)

MCD831 Major Project Part-I

6 Credits (0-0-12)

MCD832 Major Project Part-II

12 Credits (0-0-24)

MCL834 Vibroacoustics

3 Credits (2-0-2)

Excitation of vibrations, Wave types in fluids and solids. Modes of vibrations in solids. The mobility and impedance concepts, for beams and plates. Wave/boundary matching. Radiation and transmission: Acoustical radiation from structures. Transmission between structures. Fluid structure interaction: Fundamentals of fluid structure interaction. Vibroacoustic Coupling: Effects of fluid-loading on vibrating infinite and finite plates and shells. Acoustic reflection from elastic plates and shells, acoustic excitation of elastic plates and coupling between panels and acoustic spaces. Prediction models, Sound transmission loss of structures. Enclosures: Acoustic fields in enclosures, low- and high-modal density fields, Sound-isolation techniques. Numerical models and analysis use of FEM, BEM. Vibroacoustic condition monitoring, Source identification and fault detection from noise and vibration signals in Mechanical systems such as bearings, gears, fans, blower and pumps, electrical equipment etc.

MCL837 Advanced Mechanisms

3 Credits (2-0-2)

Review of mechanism analysis and synthesis through inversion. Design of parallel guidance systems, coupler curves with symmetry, cusps and crossings. Curvature theory, Euler-Savary Equations and applications. Homogenous coordinate representation of curves, coupler curves analysis and synthesis. Kinematic of spatial mechanisms, DH representation. Four points synthesis methods, circle and center point curves, branch and order defect rectification.

Compliant implementation of mechanism designs: short cantilever and long cantilever designs, folded sheet flexures and hole-hinges based implementation.

MCL838 Rotor Dynamics

4 Credits (3-0-2)

Importance of dynamics of rotors, issues involved in rotor vibration analysis, Rigid rotor and flexible rotor analysis, Lateral and Torsional vibration analysis, Response to steady state and transient excitations, bending critical speeds and response to unbalance for simple and complex rotor bearing system, orbital analysis and cascade plots, critical speed map, Campbell diagram. Disc gyroscopics, synchronous and nonsynchronous whirl, forward and backward whirl, Role of fluid film bearings and seals, analysis of rotors mounted on rolling element bearings, hydrodynamic bearings, two spool and multi-spool rotors, Dynamics of rotors with stiffness asymmetry, bend, crack and misalignment, etc.

Parametric excitations, instabilities due to fluid film forces and hysteresis, influence of nonlinear supports. Balancing techniques, such as rigid rotor balancing, modal balancing, etc. Introduction to smart rotor systems. Use of finite element based approach for solving rotor dynamic problems.

Application of vibration based condition monitoring, signal processing for rotor fault identification, application of expert systems for automated condition monitoring and rotor fault diagnosis, remote monitoring and other commercial systems.

The course involves extensive coding in Matlab for dynamic response analysis of a general rotor bearing system. It involves exercises on vibration signal processing and analysis. The course involves experimentation on Machinery Fault Simulator.

MCL840 Experimental Modal Analysis and Dynamic Design

3 Credits (2-0-2)

Introduction to modal testing. Dynamic test data measurement and processing methods including Laser vibrometry. Frequency response functions for multi-degree of- freedoms systems, forced response. Experimental and theoretical modal analysis - algorithms and codes. Applications of modal testing in system and force identification, structural dynamic modification, sensitivity analysis and frequency response coupling of substructure etc. Introduction to non-linear vibration analysis. Introduction to discrete systems and finite element modeling. Approaches to Joint modeling. Numerical model correlation; Introduction to FE model updating; Direct and iterative methods of FE model updating including optimization based updating; Brief idea of operational Modal Analysis, frequency and time domain methods of Operational Modal Analysis; Dynamic design of structures of products, machines and equipment via model testing, structural dynamic modification and FE model updating.

MCL845 Advanced Robotics

3 Credits (2-0-2)

Review of different robotic systems; Types of wheeled mobile robots and walking machines; Jacobian; Forward and inverse kinematic algorithms; Non-recursive and recursive dynamic algorithms; Dynamics of mobile robots and walking machines; Kinematic design of robotic systems based on singularity, manipulability, etc.; Control of robots. Mechanical design of links.

MCL848 Special topics in Systems Design-I

2 Credits (2-0-0)

Some sample topics are given below and depending upon the availability of experts, the department will decide the topic for a given semester:

Design of aircraft fuselage and wing

Engineering materials selection in mechanical design: Stages of design, stiffness/strength based design, damage tolerant design, life cycle design, systems approach to materials selection etc.

Tribo-systems design

Electro-mechanical machines etc.

MCL849 Special topics in Systems Design-II

3 Credits (3-0-0)

The course topic(s) will be decided by the department for each semester this course will be offered depending on the expertise available. Generally, each time a theme topic will be selected and students will work on all aspects of system design for that theme topic. Theme topic can be parts of aircraft design, automotive design, robotic design, energy system, biomedical equipment etc.

MCV849 Special Module in System Design

1 Credit (1-0-0)

Basic terminology and concept of human musculoskeletal system, anatomy and overall function; Mechanical behavior of biological tissues: bone, articular cartilage, muscle, tendon and ligament; Motion and gait analysis – method, gait cycle, segmental kinetics, engineering approaches to posture analysis; Joint replacement and fracture fixation – basic design approach.

MCD861 M.Tech. Project Part-I

12 Credits (0-0-24)

MCD862 M.Tech. Project Part-II

12 Credits (0-0-24)

MCL865 Advanced Operations Research

3 Credits (3-0-0)

Advanced Linear Programming and Simplex Method, Advanced Dynamic Programming, Integer Programming - Branch and Bound, Branch and Cut, Interior Point Methods, Selected Topics in Applied Probability, Applications.

MCL866 Maintenance management

3 Credits (3-0-0)

Introduction to maintenance management, Reliability basics, Asset criticality Analysis, Reliability centered maintenance, Basic maintenance models for age and time based replacement, block and group replacement, inspection and shock based replacement, imperfect maintenance models, Maintainability models, Availability models, Life cycle cost models, Simulation based approach for maintenance planning, Queuing models for maintenance planning, Models for condition monitoring, Models for Maintenance scheduling, Maintenance performance measurement, Asset management practices, Case studies.

MCD881 Major Project Part-I

6 Credits (0-0-12)

MCD882 Major Project Part-II

12 Credits (0-0-24)

MCD895 MS Research Project

36 Credits (0-0-72)

Department of Physics

PYL101 Electromagnetism & Quantum Mechanics

4 Credits (3-1-0)

Electromagnetism: Vector analysis, Electric and magnetic fields in media, Susceptibility and ohmic Conductivity, Maxwell's relations, interface conditions, EM wave equation, plane wave solutions, polarization of EM waves, Poynting vector and intensity, wave packets, phase and group velocities, reflection and refraction at dielectric interfaces, Brewster's angle, and total internal reflection.

Quantum Mechanics: Wave-particle duality, de-Broglie waves, quantum mechanical operators, Schrodinger equation, wave function, statistical interpretation, superposition principle, continuity equation for probability density, stationary states, bound states, free-particle solution, 1-D infinite potential well, expectation values and uncertainty relations, 1-D finite potential well, and quantum mechanical tunnelling and alpha-decay.

PYP100 Physics Laboratory

2 Credits (0-0-4)

Experiments based on Design and Study of Power sources, Charging and discharging of a capacitor, Electromagnetic Induction, Phase Measurement. Experiments on geometrical and wave optics including interference, diffraction, dispersion and polarization. Experiments based on mechanics, heat, sound, fluids, resonance, like linear air track, coupled pendulum and oscillators, thermal conductivity, elasticity. Experiments in the area of modern physics, like Planck's constant, lasers, semiconductor band gap, wave motion, mechanical transmission lines.

PYL102 Principles of Electronic Materials

3 Credits (3-0-0)

Pre-requisite(s): PYL101

(Program Linked Course: Not available to B.Tech. (Engineering Physics) students)

Energy bands in solids(KP model), Classification of electronic materials: metals, semiconductors and insulators. Free electron model, Conductivity in metals and Concepts of Fermi level, effective mass and holes, Concept of phonons, Thermoelectricity, Intrinsic, extrinsic and degenerate semiconductors, Fermi level variation by carrier concentration and temperature, Metal-semiconductor junction, p-n junction, Diffusion and drift transport, carrier life time and diffusion length; Direct and indirect band gaps, Optical transitions, photon absorption, Exciton, photovoltaic effect, Dielectrics and electrical polarization, Depolarization field, Clausius-Mossotti relation; Drude model, Electronic polarization and its mechanisms, Dielectric breakdown; Piezoelectricity, Pyroelectricity and Ferroelectricity; Magnetism in materials – types of interactions, Magnetic susceptibility, Curie and Neel temperatures; Domains, Magnetic anisotropies, Spin-orbit interaction.

PYL105 Optics and Lasers

3 Credits (3-0-0)

Pre-requisite(s): PYL101

(Program linked course: Not available to B.Tech. (Engineering Physics) students)

Basic optics: Interference and interferometers, phase change on reflection, anti-reflection film; Fresnel and Fraunhofer diffraction and examples, limit of resolution, diffraction grating, resolving power. Polarization optics, examples and applications. Lasers: Laser principles, interaction of radiation and matter, amplification and resonator conditions for laser oscillation, modes of laser, some laser systems and applications. Fiber optics: Light propagation in optical fibers, fiber communication, attenuation and dispersion, single and multi-mode fibers, fiber amplifiers and lasers, fiber optic sensors. Fourier Optics and Holography: Basics of Fourier transformation, spatial frequency, spatial filtering and some applications; Holographic principles, on-axis and off-axis holograms, types of holograms and some applications.

PYP111 Engineering Physics Laboratory-I

3 Credits (0-0-6)

Experiments with various Lasers, Optical spectrometer, Microwaves, Fundamentals of Quantum Mechanics, Atomic spectroscopy and Tunneling.

PYL113 Mathematical Physics

4 Credits (3-1-0)

Linear algebra, complex variables, partial differential equations, special functions, Fourier and Laplace transforms, integral equations, vector and tensor analysis, brief introduction to group theory.

PYL114 Solid State Physics

4 Credits (3-1-0)

Crystal Structure, concepts of reciprocal lattice and Brillouin zones, Defects in Crystals, Phonons, Crystal Vibrations with monoatomic and diatomic basis, Phonon Heat Capacity: Density of states in one dimension, Debye and Einstein models, thermal expansion, Free Electron Fermi Gas, Effect of temperature on the Fermi-Dirac Distribution, E-k diagrams, Effective Mass, Nearly free electron model, Bloch function, Kronig Penny Model, Atomic origin of magnetism: Diamagnetism, Langevin theory of paramagnetism, Curie-Weiss Law, Pauli paramagnetism, Ferromagnetism, Weiss molecular theory, Ferromagnetic domains, magnetic anisotropy, Superconductivity, types of superconductors, Heat capacity, energy gap, Thermodynamics of the superconducting transition, London equation, coherence length, BCS theory of superconductivity (qualitative), Brief introduction to high temperature superconductors.

PYL115 Applied Optics

4 Credits (3-1-0)

Geometrical and Wave Optics: Fermat's Principle, Solution of ray equation, and applications. Review of Maxwell's equations and propagation of e. m. waves, reflection and refraction, total internal reflection and evanescent waves. Surface plasmons, Meta-materials. Plane waves in anisotropic media, Wave refractive index, Uniaxial crystals, some polarization devices. Interference and Diffraction: Concept of Coherence, Interference by division of wavefront and division of amplitude; Stoke's relations; Non-reflecting films; Michelson interferometer; Fabry-Perot interferometer and etalon. Fraunhofer diffraction: Single slit, circular aperture; limit of resolution. Diffraction grating, Resolving power. Fresnel diffraction: Half-period zones and the zone plate. Diffraction of a Gaussian beam. Lasers and Fiber Optics: Interaction of radiation and matter, Einstein coefficients, condition for amplification. Optical resonators, Condition for laser oscillation. Some Laser Systems. Light propagation in optical fibers, Attenuation and dispersion; Single-mode fibers, material dispersion, Fiber amplifiers and lasers. Fiber optic sensors. Introduction to Fourier Optics and Holography.

PYL121 Mathematical Physics I

4 Credits (3-1-0)

Probability theory and Statistics, Vector Spaces and Linear Algebra, Complex Analysis, Fourier Series, Fourier and Laplace transforms and their applications to ODEs, Green's Functions and their applications to ODEs, Calculus of variation.

PYL122 Quantum Mechanics

4 Credits (3-1-0)

Dirac's bra-ket algebra, projection operator. Matrix representation of vectors and operators. Reformulating postulates in bra-ket language, Examples. 1D harmonic oscillator, ladder operators and construction of the stationary state wave functions, number operator and its eigenstates. Quantum mechanics in 2 and 3 dimensions in Cartesian coordinates. Quantum theory of angular momentum, eigenvalues and eigenfunctions. Quantum theory of spin angular momentum, addition of angular momenta and Clebsch-Gordan coefficients. Schrodinger equation in spherical coordinates, Free particle solution and solutions for spherically symmetric potentials, Hydrogen atom. Many particle Schrodinger equation, independent particles and reduction to the

system of single-particle equations. Identical particles, exchange symmetry and degeneracy, Pauli principle and its applications. EPR paradox, Entangled states, hidden variables, Bell's inequality.

PYL123 Optics and Photonics I

4 Credits (3-1-0)

Geometrical Optics: Fermat's Principle, Ray equation and its solutions. Applications in fibre optics, mirage formation, etc. Wave Propagation: Review of Maxwell's equations and propagation of waves, Plane polarized light. Reflection and refraction of e. m. wave, Brewster angle; total internal reflection and evanescent waves. Reflection by a conducting medium. Anisotropic Media: Plane waves in anisotropic media, Birefringence, Uniaxial crystals; Analysis of polarized light; some polarization devices. Interference: Interference by division of wavefront and division of amplitude; Phase change on reflection, Stoke's relations; Reflecting and nonreflecting films; Colors of thin films. Michelson interferometer; Fabry-Perot interferometer and etalon, some applications. Diffraction: Fresnel and Fraunhofer diffraction. Single slit, circular aperture; limit of resolution. Double slit, Diffraction grating, Resolving power. Fresnel half-period zones and the zone plate. Diffraction of a Gaussian beam. Fourier Optics: Fourier transform operation spatial frequency and transmittance function, spatial-frequency filtering, Phase contrast microscope. Holography: Principle of holography, On-axis and Off-axis hologram recording and reconstruction, types of hologram and some applications.

PYL125 Solid State Physics I

4 Credits (3-1-0)

Crystal Structure, concepts of reciprocal lattice, Weigner Seitz cell, Energy Bonds, Defects in Crystals, Phonons, Crystal Vibration with monoatomic and diatomic basis, M-B, B-E and F-D statistics, Phonon Heat Capacity: Density of states in one dimension, Debye and Einstein Models, thermal expansion, free Electron Fermi Gas, Effect of temperature on the Fermi-Dirac Distribution, E-k diagrams, Effective Mass, Nearly free electron model, Bloch function, Kronig Penny Model, Brillouin zone, Tight binding approximation, Energy bands in semiconductor, Equilibrium distribution, carrier and transport, thermoelectric effect.

PYL127 Classical Mechanics & Relativity

4 Credits (3-1-0)

Dynamics of a particle moving under Central Force, Canonical transformation and Poisson bracket formulation, Hamilton-Jacobi's theory, Non inertial (rotating) frames of references, Relativistic Mechanics.

PYL202 Statistical Physics

4 Credits (3-1-0)

Pre-requisite(s): PYL122

Elementary Probability Theory: Binomial, Poisson and Gaussian Distribution, random walk problem, central limit theorem and its significance, average and distributions; diffusion and Brownian motion and their relation to random walk problem; Macrostate and microstate, Postulates of Statistical Mechanics, rules of calculations through microcanonical, canonical and grand canonical ensembles; Derivation of the thermodynamic relations from the statistical mechanics ; Application to classical systems: Systems of ideal gas molecules, Maxwell Boltzmann velocity distribution, paramagnetism of non interacting spins; specific heat of solids; Concept of Thermodynamic stability and Phase Transition: Vander Waal equation of state, Ising model, critical exponents; Indistinguishability of particles and Quantum Statistical Mechanics; Bose Einstein and Fermi-Dirac distribution: Black Body radiation, Bose Einstein Condensation, Fermi level and electronic contribution to specific heat, White Dwarf stars and Chandrasekhar Limit.

PYL204 Computational Physics

4 Credits (3-1-0)

Pre-requisite(s): PYL113

Introduction to the basic numerical tools, such as locating roots of equations, interpolation, numerical differentiation and integration,

solutions of algebraic and differential equations, discrete Fourier transform, etc. Applications of Monte-Carlo simulations, optimization and variational methods etc. to problems of interest in multiple areas of Physics.

PYL205 Electrodynamics

4 Credits (3-1-0)

Electrostatics and magnetostatics. Laplace and Poisson equations (solution), method of images. Multipole expansion. Maxwell's equations. Wave equation. Frequency dependence of permittivity. Absorption and dispersion. Kramers-Kronig relations. Conservation laws: Continuity equation, Poynting theorem, stress-energy tensor and Conservation of momentum. Solutions of Maxwell's equations in terms of potentials. Gauge transformations. Continuous distribution and retarded potentials. Lienard-Wiechert potentials. Field of moving point charge. Radiation, Electric dipole radiation, magnetic dipole radiation, Radiation from an arbitrary source. Power radiated by a point charge. Radiation reaction. Four vectors, Transformations of four vectors and tensors under Lorentz transformations. Formulation of Maxwell's equations in relativistic notations. Transformations of electric and the magnetic field vectors. Magnetism as a relativistic phenomenon. Lagrangian formulation of the electromagnetic field equations. Euler-Lagrange equations.

PYL206 Mathematical Physics II

4 Credits (3-1-0)

Pre-requisite(s): PYL121

Introduction to partial differential equations, vector and tensor analysis, special functions, Integral equations, Introduction to group theory.

PYL208 Solid State Physics II

3 Credits (3-0-0)

Dielectric Properties of insulators: Depolarization Field, Local electric field at an atom, Dielectric Constant and Polarizability, Clausius Mossotti relation, Kramers-Kronig relations, dielectric strength and insulation breakdown. Structural phase transition: Landau Theory of Phase transition, Piezo, Ferro and Pyro electricity. Atomic origin of magnetism: Diamagnetism, Langevin theory of paramagnetism, Curie-Weiss Law, Ferromagnetism, Weiss molecular theory, Ferromagnetic domains, magnetic anisotropy, Band theory of Ferrimagnetism. Superconductivity, types of superconductors, Heat capacity, energy gap, Thermodynamics of the superconducting transition, London equation, coherence length, BCS theory of superconductivity (qualitative), Brief introduction to high temperature superconductors.

PYL209 Optics and Photonics II

3 Credits (3-0-0)

Lasers: interaction of radiation and matter, Einstein coefficients, condition for amplification. Optical resonators, Condition for laser oscillation. Longitudinal and transverse modes of a laser. Some Laser Systems. Fiber Optics: Light propagation in optical fibers, Attenuation and dispersion; Single-mode fibers, material dispersion. Optical fiber communication, Fiber amplifiers and lasers. Optical fibers in sensing. Electro-Optic (E.O) Effect: Phase-and amplitude modulators. E.O. effect in liquid crystals; LCDs and SLMs. Magneto-optic effect: Faraday rotation. Acousto-Optic (A.O.) Effect: Raman-Nath and Bragg diffraction; A.O. modulators and deflectors. Nonlinear Optics: Second order and third order effects, Phase-matching schemes. Self-phase modulation and optical solitons; Cross phase modulation and four wave mixing. Stimulated Raman scattering (SRS) and stimulated Brillouin scattering (SBS) Quantum Optics: Quantum states of light and their properties, Generation and detection of quantum light Entanglement and its applications: quantum computing, cryptography and teleportation.

PYP212 Engineering Physics Laboratory-II

3 Credits (0-0-6)

Pre-requisite(s): PYL115

Characterisation of optoelectronic/semiconductor devices, Holography, Determination of characteristic parameters of different types of optical fibers, Applications of Fiber Optics: experiments related to communication and sensors.

PYP221 Engineering Physics Laboratory-III

3 Credits (0-0-6)

Pre-requisite(s): PYL114

Synthesis of thin films, multilayers, nanoparticles by physical and chemical vapor deposition techniques, phase diagrams, study of surface, design of thin film resistor and magnetic field sensor.

PYP222 Engineering Physics Laboratory-IV

3 Credits (0-0-6)

Pre-requisite(s): PYL114

Resistivity of metals and semiconductors, band gap, charge carrier density and mobilities of semiconductor, basics of junction diode and its characteristics in solar cell configuration, study of crystal structure, dielectric constant, specific heat and superconductivity.

PYS 300 Independent Study

3 Credits (0-3-0)

The course details to be worked out by the faculty giving the course keeping in view the learning needs of the students.

PYL 301 Vacuum Technology and Surface Science

3 Credits (3-0-0)

Need of Vacuum and basic concepts: Mean free path, Particle flux; Monolayer formation, Gas Flow regimes ; Gas release from Solids: Vaporization, Thermal Desorption, Permeation, Surface diffusion, Physisorption and Chemisorption; Measurement of Pressure: Gauges, Residual Gas Analyses; Production of Vacuum: Roughing - Rotary pumps, Oil free pumps; HV & UHV - Turbomolecular pumps, Cryopumps, Getter and Sputter Ion pumps; Materials and components in vacuum; Bulk versus surface; Electronic properties of surfaces: Contact potential and work function, Surface Plasmons; Atomic motion: Surface lattice dynamics, Surface diffusion, Surface melting and chemisorption; Adsorption of atoms and molecules; Experimental techniques for surface analysis: XPS, AES, SEXAFS, TEM, SEM, STM, AFM and RHEED.

PYL302 Nuclear Science and Engineering

3 Credits (3-0-0)

Pre-requisite(s): PYL122

Introduction to nuclear structure, Radioactivity and applications, Nuclear detection and acceleration technology, Nuclear reactors engineering, Nuclear techniques for composition analysis, Nuclear radiation in biology.

PYL303 Materials Science and Engineering

3 Credits (3-0-0)

Pre-requisite(s): PYL114

Elementary materials science concepts, thermally activated processes, diffusion in solids, phase diagram of pure substances, Gibbs phase rule, binary isomorphous systems, the Lever rule, zone refining, homogeneous and heterogeneous nucleation, martensitic transformation & spinodal decomposition, Temperature dependence of resistivity, Matthiessen's rule, TCR, Nordheim's rule, mixture rules and electrical switches, high frequency resistance of a conductor, thin metal films and integrated circuit inter-connections, thermoelectricity, seebeck, Thomson and Peltier effects, thermoelectric heating and refrigeration, thermoelectric generators, the figure of merit, Bonding characteristics and elastic moduli, anelasticity, thermoelasticity, anelasticity energy losses, viscoelastic deformation, displacement models, Corrosion and Degradation of Materials: Electrochemical considerations, corrosion rates and their prediction, passivity environmental effects, forms of corrosion, corrosion environments, corrosion prevention, oxidation, protective and non-protective oxides, PB ratio, mechanisms of oxide growth, Materials Selection and Design Considerations.

PYL304 Superconductivity and Applications

3 Credits (3-0-0)

Pre-requisite(s): PYL114

Basic properties: zero resistance, perfect diamagnetism, difference

from perfect conductors; Critical temperature, Basic Introduction to High Temperature superconductors, Meissner effect, London equations, penetration depth, flux quantization, critical current and critical magnetic field, Thermodynamics of superconducting state, Type I and Type II superconductors, BCS theory, electron pairs; coherence length; energy gap; Isotope effect, Ginzburg-Landau Theory, tunneling of electron in M/I/S, tunneling of electron pairs in S/I/S: DC and AC Josephson effect. Some applications: Electromagnet, SQUID, Oscillators, basics of superconducting electronics and superconducting quantum computing.

PYL305 Engineering Applications of Plasmas

3 Credits (3-0-0)

Pre-requisite(s): PYL205

Plasma processing of materials, surface cleaning, etching, power/fusion energy, coherent radiation generation, plasma processing of textiles, nitriding, surface modification, plasma based charged particle accelerators, Hall thrusters.

PYL306 Microelectronic Devices

3 Credits (3-0-0)

Pre-requisite(s): PYL201

Brief overview of semiconductor fundamentals; pn junction diode - energy-band diagrams, electrostatics, current - voltage relationship, junction-breakdown mechanisms. Metal-semiconductor contacts: Schottky barrier diode, C-V and I-V characteristics of Schottky diode; ohmic contacts in semiconductors. MOS structure: Accumulation, depletion and inversion modes of operation, charge - voltage and capacitance - voltage behaviour, threshold and flatband voltages, fixed oxide and interface charge effects. MOSFET: Output and transfer characteristics, I-V relations, nonideal effects, MOSFET scaling. BJT: BJT action, current gain factors, modes of operation, I-V characteristics of a BJT, non-ideal effects, cutoff frequency of a BJT.

PYL307 Elements of Material Processing

3 Credits (3-0-0)

Fundamentals of thermodynamic and kinetic aspects during nucleation and growth processes, Film growth modes, 2-D growth, Epitaxy and lattice misfits, Molecular beam epitaxy, Basics of vacuum, plasma discharge and sputtering, importance for material growth, Energy enhanced processes for low temperature processing, Reactive sputtering, Ion-beam deposition, Pulsed Laser Deposition, Plasma etching, E-beam and Ion-beam patterning, Chemical Vapor Deposition, Chemical Bath Deposition and Electrodeposition, Chemical epitaxy, Need for Epitaxy and its role in semiconductor devices, quantum wells, superlattices and hybrid structures. Mechanisms for confined materials growth for 0-D, 1-D and 2-D architecture and other complex forms, Case studies of material design by taking examples from current and emerging aspects of technologies and applications.

PYL311 Lasers

3 Credits (3-0-0)

Pre-requisite(s): PYL115

Interaction of Radiation with Matter: Einstein coefficients; Line shape function, Line-broadening mechanisms, Condition for amplification by stimulated emission, the meta-stable state and laser action. 3-level and 4-level pumping schemes. Laser Rate Equations: Two-, three- and four-level laser systems, condition for population inversion, gain saturation; Laser amplifiers; Rare earth doped fiber amplifiers. Optical Resonators: Modes of a rectangular cavity, Plane mirror resonators, spherical mirror resonators, ray paths in the resonator, stable and unstable resonators, resonator stability condition; ring resonators; Transverse modes of laser resonators. Gaussian beams in laser resonators. Laser Oscillation: Optical feedback, threshold condition, variation of laser power near threshold, optimum output coupling, Characteristics of the laser output, oscillation frequency, frequency pulling, hole burning and the Lamb dip; Mode selection, single-frequency lasers; Methods of pulsing lasers, Q-switching, mode-locking. Some Laser Systems: Ruby, Nd: YAG, He-Ne, CO₂ and excimer lasers, Tunable lasers: Ti Sapphire and dye lasers, Fiber lasers, Semiconductor lasers; Laser safety.

PYL312 Semiconductor Optoelectronics

3 Credits (3-0-0)

Pre-requisite(s): PYL201

Energy bands in solids, density of states, occupation probability, Fermi level and quasi Fermi levels, p-n junctions, Semiconductor optoelectronic materials, bandgap modification, Heterostructures and Quantum Wells. Rates of emission and absorption, condition for amplification by stimulated emission, the laser amplifier. Semiconductor Photon Sources: Electroluminescence. The LED, Semiconductor Laser, Single-frequency lasers; DFB and DBR lasers, VCSEL; Quantum-well lasers and quantum cascade lasers. Laser diode arrays. Semiconductor optical amplifiers (SOA), Electro-absorption modulators based on FKE and QCSE. Semiconductor Photodetectors: Types of photodetectors, Photoconductors, Photodiodes, PIN diodes and APDs. Quantum well infrared photodetectors (QWIP); Noise in photodetection; Photonic integrated circuits (PICs).

PYL313 Fourier Optics and Holography

3 Credits (3-0-0)

Pre-requisite(s): PYL115

Signals and systems, Fourier transform (FT), FT theorems, sampling theorem, Space-bandwidth product; Review of diffraction theory: Fresnel-Kirchhoff formulation, Fresnel and Fraunhofer Diffraction and angular spectrum method, FT properties of lenses and image formation by a lens; Frequency response of a diffraction-limited system under coherent and incoherent illumination. Basics of holography, in-line and off-axis holography, plane and volume holograms, diffraction efficiency; Recording medium for holograms; Applications of holography: display, microscopy; memories, interferometry, NDT of engineering objects, Digital Holography etc.; Holographic optical elements. Analog optical information processing: Abbe-Porter experiment, phase contrast microscopy and other simple applications; Coherent image processing: vander Lugt filter; joint-transform correlator; pattern recognition, image restoration.

PYL321 Low Dimensional Physics

3 Credits (3-0-0)

Pre-requisite(s): PYL201 (Only for students opting for Minor Area)

Brief overview of band structure and density of states function for 0D, 1D and 2D systems, band gap engineering and semiconductor heterostructures. Quantum wells and their optical properties, multiple quantum wells and superlattices, Bloch oscillations. Two dimensional electron gas, modulation doped heterostructures, Quantum Hall effect. Quantum wires and nanowires, electronic transport, properties and applications. Quantum dots and their optical properties, Coulomb blockade. Device applications of low dimensional systems: Double heterostructure laser, quantum cascade laser, high electron mobility transistors. 2D materials: Graphene, topological insulators, WS₂ / MoS₂ and their properties.

PYL322 Nanoscale Fabrication

3 Credits (3-0-0)

Pre-requisite(s): PYL201

Nucleation and growth, Basic principles involved in growth with controllable dimensions, Chemical and physical techniques for growth of nanoparticle, nanorod, ultrathin films, monolayer materials, multilayer structures, nanocomposite materials. Self organized growth on substrates and templates. Micro and nanoscale patterning techniques.

PYL323 Nanoscale Microscopy

2 Credits (2-0-0)

Pre-requisite(s): PYL201

Scanning probe microscopy such as scanning electron microscope, atomic force microscope, scanning electron microscope. Transmission electron microscope with high resolution and near field optical microscopy.

PYL324 Spectroscopy of Nanomaterials

2 Credits (2-0-0)

Pre-requisite(s): PYL201

Absorption and Reflection spectroscopy, molecular spectroscopy fundamentals, band-gaps and quantum confinement effects, Photoluminescence and Electroluminescence spectroscopy: Origin of emissions, Infrared and Raman Spectroscopy: Vibration spectroscopy principles, Time-domain spectroscopy, Nonlinear optical spectroscopy, Single molecule single nanoparticle detection. X-Ray Diffraction: Overview of basics, Intensities of diffracted beams, structure of polycrystalline aggregates, determination of crystallite size. X-Ray Absorption Spectroscopy: Fundamentals, Qualitative analysis of XANES and EXAFS data. X-Ray Photoelectron Spectroscopy and Auger Electron Spectroscopy: Principles of the method, initial- and final-state effects, Applications and case studies using all techniques specific to nanomaterials, Introduction to synchrotron radiation and its application to study nanomaterials.

PYL331 Applied Quantum Mechanics

3 Credits (3-0-0)

Pre-requisite(s): PYL122

Electron in a magnetic field, Landau levels, Quantum Hall effect, Aharonov-Bohm effect. Non-degenerate and Degenerate Time-independent perturbation theory, Examples: Stark effect, Atomic fine-structure, Atomic Hyperfine-structure, Zeeman Effect. Variational method, Examples, WKB Approximation, Examples and comparison. Time-dependent Perturbation theory, Examples, Fermi Golden Rule. Interaction of radiation with matter: Absorption and emission of radiation, Selection rules. Scattering theory: Scattering amplitude, Differential and total cross-sections, Born's Approximation, Scattering by spherically symmetric potentials, Examples, Rutherford's formula for Coulomb scattering, Partial wave analysis and Optical theorem, Examples. Relativistic Quantum Mechanics: Klein-Gordon equation, Properties of the free-particle KG equation including negative energy solutions. Dirac equation: The Dirac matrices and Dirac algebra. Spin of the Dirac particle. Dirac particle in an electromagnetic field, including the Pauli equation, magnetic moment and the g-factor, Free particle plane wave solutions, including negative and positive energy solutions.

PYL332 General Theory of Relativity & Cosmology

3 Credits (3-0-0)

Pre-requisite(s): PYL127

Revision of special relativity, Notations, Equivalence principle, Introduction to tensor calculus, Metric, Parallel transport, covariant derivative and Christoffel symbols, Geodesic, Riemann curvature tensor, Ricci tensor, Geodesic deviation equation, Stress-Energy tensor, Einstein equation, Meaning of Einstein equation, Schwarzschild solution, Trajectories in Schwarzschild space-time, Perihelion shift, Binary pulsars, Gravitational deflection of light, Gravitational lensing, Gravitational collapse, Black holes, Hawking Radiation, Gravitational waves, Cosmology: Models of the universe and the cosmological principle, Cosmological metrics, Types of universe, Robertson-Walker universes, Big Bang, Dark energy.

PYD411 Project-I

4 Credits (0-0-8)

To set the objectives, deliverables, work plan, logistics planning and milestones with discernible outputs, and to demonstrate the feasibility through some specific aspects of a project.

PYL411 Quantum Electronics

3 Credits (3-0-0)

Pre-requisite(s): PYL122

Light propagation through anisotropic media, nonlinear effects, nonlinear polarization, Second harmonic generation, sum and difference frequency generation, parametric amplification, parametric fluorescence and oscillation, concept of quasi-phase matching; periodically poled materials and their applications. Third-order effects:

self-phase modulations, temporal and spatial solitons, cross-phase modulation, stimulated Raman and Brillouin scattering, four-wave mixing, phase conjugation. Quantization of the electromagnetic field; number states, coherent states and their properties: squeezed states of light and their properties, application of optical parametric processes to generate squeezed states of light, entangled states and their properties; Generation of entangled states; Quantum eraser, Ghost interference effects; Applications in quantum information science. Ultra-intense laser-matter interactions.

PYD412 Project-II

8 Credits (0-0-16)

Pre-requisite(s): PYD 411

Open to only those students opting for Departmental Specialization. The Project can be a continuation of the project undertaken for PYD 411. The students will be eligible to do this project, if he/she secures a grade not below B in PYD411.

PYL412 Ultrafast Laser Systems and Applications

3 Credits (3-0-0)

Pre-requisite(s): PYL311

Review of Laser Physics: Gain media, laser oscillation, spectral line broadening, mode selection, Q-switching and mode-locking. Generation of Ultrashort Pulses: Temporal, spectral and spatial properties of pulses, Group velocity dispersion, Self-phase modulation; Pulse chirping, broadening and compression; Optical solitons, Chirp filters; High repetition-rate, high-energy few-cycle pulses. Measurement of Ultrashort Pulses: Optical and electronic pulse profiling; Intensity autocorrelation; Spectral measurement and frequency gating, FROG; Spectral interferometry, SPIDER. Ultrafast Optical Processes: Higher harmonic generation, Supercontinuum generation, Attosecond generation, Ultra-wideband optical parametric amplification. Femtosecond Laser Systems: Solid-state laser and fiber laser based systems, next-generation mid-IR lasers. Ultrafast Laser Processing: Laser ablation and surface micro/nano-structuring, Laser inscription of photonic devices, fabrication of optical waveguides and micro-fluidic chips. Ultrafast Spectroscopy: Transient absorption and emission spectroscopy, Terahertz spectroscopy; Femtosecond optical frequency combs and their applications.

PYL413 Fiber and Integrated Optics

3 Credits (3-0-0)

Pre-requisite(s): PYL115

Modes in planar optical waveguides: TE and TM modes, Modes in channel waveguides: Effective index and Perturbation method. Directional coupler: coupled mode theory, Integrated Optical devices: Prism Coupling, optical switching and wavelength filtering etc. Step Index and graded index fibers, Attenuation in optical fibers, LP Guided Modes of a step-index fiber, Single-mode fibers, Gaussian approximation and splice loss. Pulse dispersion, Dispersion compensation, Basics of Optical Communication Systems, and recent trends. Fiber fabrication technology and fiber characterization. Periodic interaction in waveguides: Coupled Mode Theory, Fiber Bragg Gratings, Long period Gratings and applications, Optical fiber sensors: basic principles and applications.

PYD414 Project III

4 Credits (0-0-8)

Pre-requisite(s): PYD411

Working out the detailed work plan and implementation of the project. The Project can be a continuation of the project undertaken for PYD 411.

PYL414 Engineering Optics

3 Credits (3-0-0)

Pre-requisite(s): PYL115

Lens systems and basic concepts in their design; Optical components: Mirrors, prisms, gratings and filters; Sources, detectors and their

characteristics; Optical systems: Telescopes, microscopes, projection systems, photographic systems, interferometers and spectrometers; Concepts in design of optical systems; Applications in industry, defense, space and medicine; CCD, compact disc, scanner, laser printer, photocopy, laser shows, satellite cameras, IR imagers, LCD, Spatial Light modulators.

PYV418 Selected Topics in Photonics

2 Credits (2-0-0)

Pre-requisite(s): PYL115

Topics from the emerging areas of Photonics will form the basics, and the faculty offering the course will provide the detailed course contents.

PYV419 Special Topics in Photonics

1 Credit (1-0-0)

Pre-requisite(s): PYL115

Topics from the emerging areas of Photonics will form the basics, and the faculty offering the course will provide the detailed course contents.

PYL421 Functional Nanostructures

3 Credits (3-0-0)

Pre-requisite(s): PYL201

Basics of low dimensional structures, QD, QW, nanostructures for optical and electronic applications, QD lasers, detectors, SET, Carbon based nanostructures, CNT, CNT optical, electrical, mechanical, chemical properties, sensors, drug delivery, photonic crystals, GMR, nanostructured magnetism, hydrogen storage, nanoclays, colloids, nanomachines, organic and biological nanostructures.

PYL422 Spintronics

3 Credits (3-0-0)

Pre-requisite(s): PYL122

Spintronics, its need and future vision; Basics of magnetic materials, spin orbit interaction, spin polarized current and their injection, accumulation and detection, Magnetoresistance and concepts of spin detection and magnetic memory; Spin valves & GMR, CIP and CPP transport, Semiclassical transport models; Basics of spin valve and magnetic tunnel junctions, Tunnel magneto resistance, Quantum mechanical model of coherent tunneling and Giant TMR; Magnetic anisotropies and exchange bias, Spin valves with AF and SAF layers, Magnetization switching in AF and SAF layers, Magnetic domains and domain walls, single domain nano-particles; Pure spin and charge currents, spin-Hall effect and inverse spin-Hall effect, spin Seebeck effect, magneto-caloric effect, generation of spin current by charge and thermal current; Current induced magnetization switching, Spin torque effect and spin torque oscillators of tunable GHz frequency; High density data storage: MRAM, two stable states, half-select problem, Savtchenko switching and Toggle MRAM; Ultra high density devices: Current & STT driven DW motion, Race track memory, Shift resistor; Q-bits and spin logic.

PYL423 Nanoscale Energy Materials and Devices

3 Credits(3-0-0)

Pre-requisite(s): PYL201

Basics of photovoltaics, Quantum confinement and plasmonics in photovoltaic devices, Nanorod solar cells, Principle of operation of hybrid and dye-sensitized solar cells, Nanoscale materials for improving thermoelectric figure of merit, Photoelectrochemical cells.

PYV428 Selected Topics in Nanotechnology

Pre-requisite(s): PYL201

2 Credits (2-0-0)

Topics from the emerging areas of Nanotechnology will form the basics and the faculty offering the course will provide the detailed course contents.

PYV429 Special Topics in Nanotechnology

1 Credit (1-0-0)

Topics from the emerging areas of nanotechnology will form the basics and the faculty offering the course will provide the detailed course contents.

PYL431 Relativistic Quantum Mechanics

2 Credits (2-0-0)

Pre-requisite(s): PYL331

Revision of Lorentz transformations, relativistic notations, Lorentz group. The Klein-Gordon equation, negative and positive energy solutions. Charged spin-zero particle, Difficulties with K-G theory. The Dirac equation, Relativistic invariance, Relativistic invariance, spin and energy projection operators. Nonrelativistic limit, Pauli equation, Solutions and their properties. Dirac sea, Anti-particle, Klein paradox, Fodly-Wouthuysen representation. Hydrogen atom, Dirac electron in an electromagnetic field, Charge conjugation.

PYL432 Quantum Electrodynamics

3 Credits (3-0-0)

Pre-requisite(s): PYL331

Lagrangian formulation of classical field theory, Field equations, symmetries, Noether's theorem and conservation laws. Energy-momentum tensor. Classical field equations: Neutral and charged scalar fields, Electromagnetic field, Dirac field, Momentum representation, Second quantization of the free fields, Interacting fields, interaction picture, Dyson-series, Feynman diagrams and Feynman rules for quantum electrodynamics. Wick's theorem. Cross-section and S-matrix, Moeller and Bhabha scattering, Compton scattering, photoelectric effect etc. Divergence, Renormalization technique, Mass and charge renormalization.

PYL433 Introduction to Gauge Field Theories

2 Credits (2-0-0)

Pre-requisite(s): PYL205 & PYL122

Maxwell's equations and Gauge invariance, Quantum mechanics of a charged particle as a gauge theory, Vector potential as phase, Aharonov-Bohm Effect, Superconductivity and Magnetic flux quantization in superconductors, Introduction to continuous symmetry groups, U(1) and SU(2) symmetry groups, Classical field theories, Local gauge invariance and the gauge fields, Yang-Mills gauge theories, Spontaneous symmetry breaking, Goldstone bosons, Higgs mechanism, Weinberg-Salam Model.

PYL434 Particle Accelerators

2 Credits (2-0-0)

Pre-requisite(s): PYL205 & PYL122

Electrostatic and electromagnetic accelerators: Van de Graff, Tandem acceleration, Linear accelerators, Synchrocyclotron, Storage ring, Free electron laser, High energy colliders.

PYL435 Advanced Computational Physics

3 Credits (2-1-0)

Pre-requisite(s): PYL204, PYL202

Introduction to computer simulation, Model systems and interaction potential, Relation of Physics and computer simulations, Basic Monte Carlo simulation in equilibrium and non-equilibrium systems, Introduction to Molecular dynamics, Molecular Dynamics in equilibrium and non-equilibrium systems. Analysis of the results.

PYV438 Selected Topics in Theoretical Physics

2 Credits(2-0-0)

Pre-requisite(s): PYL122

Topics from the emerging areas of Theoretical Physics will form the basics, and the faculty offering the course will provide the detailed course contents.

PYV439 Special Topics in Theoretical Physics

1 Credit (1-0-0)

Pre-requisite(s): PYL122

Topics from the emerging areas of Theoretical Physics will form the basics, and the faculty offering the course will provide the detailed course contents.

PYL551 Classical Mechanics

4 Credits (3-1-0)

Constraints, generalized coordinates, action principle, symmetries and conservation laws, Hamilton's equations, Poisson brackets, canonical transformations, central potentials, small oscillations, normal modes, rigid body dynamics.

PYL552 Electrodynamics

4 Credits (3-1-0)

Electrostatics, conductors, dielectrics, magnetostatics, boundary value problems, time dependent fields, waves in a medium, relativistic formulation of Maxwell's equations, radiation from accelerating charges, scattering of electromagnetic waves.

PYL553 Mathematical Physics

4 Credits (3-1-0)

Linear Algebra, complex analysis, Fourier transform, Sturm-Liouville's theorem and orthogonal functions, Ordinary differential equations, Green Functions/old methods.

PYL555 Quantum Mechanics-I

4 Credits (3-1-0)

Introduction, quantum mechanical wave function, Born interpretation, basic formalism (Dirac bra-ket formalism), state vectors, operators and their representation, review of one dimensional examples, one dimensional harmonic oscillator, creation and annihilation operators, Landau problem, symmetries in quantum mechanics, hydrogen atom, entanglement.

PYL556 Quantum Mechanics-II

3 Credits (3-0-0)

Time independent perturbation theory, time dependent perturbation theory, cross-section, scattering theory, approximation techniques, identical particles, interaction of atoms with radiation, relativistic equations.

PYL557 Electronics

4 Credits (3-1-0)

Basics of semiconductor devices such as diode, transistor, FET and MOSFET; BJT and FET based amplifiers, oscillators, switches, circuit analysis by hybrid and r-parameters, operational amplifiers and their applications, timer circuit, dc power supplies, filters and digital circuits, counters, registers, ADC, DAC and microprocessor.

PYL558 Statistical Mechanics

4 Credits (3-1-0)

Introduction to statistical methods. Some basic notions of random walks, Poisson distribution, Gaussian distribution. Statistical basis for thermodynamics: macrostates, microstates, Gibb's paradox. Gibb's ensemble theory: phase space perspective, Liouville's theorem, microcanonical, canonical and grand canonical ensembles, partition function, calculations of physical properties of classical systems using ensemble approach, thermodynamic relations. Applications of ensemble theory, quantum statistical mechanics: density matrix approach, statistical mechanics of Bosons and Fermions, Bose-Einstein condensation, Pauli paramagnetism, Landau diamagnetism, quantum statistics of harmonic oscillators, non-ideal gases, virial expansion, brief introduction to phase transitions, critical phenomena, transfer matrix approach, application to 1-D Ising model.

PYL560 Applied Optics

4 Credits (3-1-0)

Electromagnetic waves in a medium: review of Maxwell's equations and propagation of electromagnetic waves, various states of polarization and their analysis. Anisotropic media, plane waves in anisotropic media, uniaxial crystals, some polarization devices. Diffraction: scalar waves, the diffraction integral, Fresnel and Fraunhofer diffraction, diffraction of a Gaussian beam, diffraction grating. Fourier optics and holography: spatial frequency and transmittance function, Fourier transform by diffraction and by lens, spatial-frequency filtering, phase-contrast microscope. Holography: on-axis and off-axis hologram recording and reconstruction, types of hologram and some applications. Coherence and Interferometry: Spatial and temporal coherence, fringe visibility, Michelson stellar interferometer, optical beats, multiple beam interference, Fourier transform spectroscopy. Guided wave optics: Modes of a planar waveguide, optical fibers: step-index and graded index fibers, waveguide theory and quantum mechanics, applications of optical fibers in communication and sensing.

PYD561 Project-I

3 Credits (0-0-6)

PYP561 Laboratory-I

4 Credits (0-0-8)

PYD562 Project-II

6 Credits (0-0-12)

PYP562 Laboratory-II

4 Credits (0-0-8)

PYL563 Solid State Physics

4 Credits (3-1-0)

Crystal lattices, Reciprocal lattice, equivalence of Bragg and Laue formulations, Ewald Construction, bonding & packing in crystals.

Free electron theory: Drude and Sommerfeld's model of conductivity.

Electrons in a Periodic Potential, Bloch theorem in lattice and reciprocal space, origin of band gap in a weak periodic potential, Kronig-Penney model, band structures, metal, insulator, semiconductor, concepts of effective mass, light and heavy holes in a semiconductor, optical properties of semiconductors. Wannier functions, Tight binding model and calculation of band structure, Fermi Surfaces. Thermal Properties: classical & quantum theory of harmonic crystal in one, two, & three dimensions, specific heat at high and low temperatures, normal modes & phonons, Einstein & Debye models of specific heat. Ferroelectric, Piezoelectric Magnetism: Diamagnetism, Paramagnetism, Hund's Rule, Curie's Law, Cooling by Diamagnetism, Pauli Paramagnetism, Curie-Weiss Law Ferromagnetism and Antiferromagnetic ordering, Domains. Superconductivity: Basic Phenomenology, Meissner effect, London penetration depth, coherence length, Flux quantization.

PYP563 Advanced Laboratory

4 Credits (0-0-8)

PYL567 Atomic and Molecular Physics

3 Credits (3-0-0)

Hydrogen and alkali metals, double fine structure of atoms, two electron atom, Zeeman and Paschen-Back effect, X-ray spectra, general factors influencing spectral line width (Collision, Doppler effect, Heisenberg) and line intensities (transition probability, population of states, Beer-Lambert law), Molecular symmetry, irreducible representations, Rotational and vibrational spectra of diatomic molecules, FTIR and Laser Raman spectroscopy, electronic spectra, Franck-Condon principle, bond dissociation energies, Molecular orbital and models, laser cooling of atom.

PYL569 Nuclear and Particle Physics

3 Credits (3-0-0)

N-N interaction, iso-spin symmetry, nuclear models, beta decay,

detectors and particle accelerators, Quark model, Deep inelastic scattering, Basics of nuclear astrophysics, Fundamental particles and their properties.

PYL650 Fiber and Integrated Optics

3 Credits (3-0-0)

Modes in planar optical waveguides: TE and TM modes. Modal analysis of a parabolic index medium. Modes in channel waveguides: Effective index method, Perturbation method and Variational method. Modes in multilayered waveguides: Matrix method. Directional coupler: coupled mode theory, Integrated Optical devices: Prism Coupling, optical switching, modulators and wavelength filters, etc. Step Index and graded index fibers, Attenuation in optical fibers, LP Guided Modes of a step-index fiber, Single-mode fibers, Gaussian approximation and splice losses. Dispersion in optical fibers, Pulse dispersion, Dispersion management. Fabrication and characterization of optical waveguides. Fiber optic components and devices. Optical fiber sensors; Basic principles and applications.

PYL651 Advanced Solid State Physics

3 Credits (3-0-0)

Pre-requisite(s): PYL563

Semiclassical model of electron dynamics, Electrons in static electric and magnetic fields, DC and AC electrical conductivity in metals, Sources of electron scattering, Boltzmann equation, Temperature dependence of electronic conductivity, Dielectric properties of insulators, Piezoelectric, Ferroelectric, Pyroelectric, Optical properties of solids, Electrons in magnetic fields, Landau Levels, Cyclotron resonance, Density of states in magnetic field, De-Haas Van Alfen effect, Quantum Hall effect, Models for ferromagnetism, Magnetic phase transition, Properties of Superconductors, Ginzburg-Landau theory, Josephson effect, Squids Microscopic Theory of superconductivity: Cooper pairs, BCS theory.

PYL652 Magnetism and Spintronics

3 Credits (3-0-0)

Pre-requisite(s): PYL563

Magnetism of metals, Spontaneous spin split bands, Magnetic anisotropy, Competing interactions, One and two-dimensional magnets, Spin dependent transport in magnetic metals - Anisotropic magnetoresistance, Giant magnetoresistance, Spin dependent tunneling, Tunneling magnetoresistance, Spin-Orbit interaction and Hall effects -Spin Hall Effect and Inverse Spin Hall Effect; Spin injection phenomena - Spin Transfer Torque, Spin injection magnetization reversal; High frequency phenomena.

PYL653 Semiconductor Electronics

3 Credits (3-0-0)

Pre-requisite(s): PYL563 or equivalent

Semiconductors junction review; charge storage and transient behavior, equivalent circuit of diode, p-n hetero-structure: band discontinuity and its effect on junction properties; Junction breakdown mechanisms; Static characteristics of Bipolar transistor; Frequency response and switching behavior, Non-ideal effects: base width modulation, early effect, current crowding and high injection effect; Hetero-junction transistor; SCR, M-S junctions: Basic structure, Energy band relation, I-V characteristics; Ohmic contacts; MOS capacitors, JFET and MESFET basic principles, MOSFET: structure and operation, basic characteristics and analysis; linear quadratic model; equivalent circuit; Threshold voltage calculation; Substrate biasing effect; LED, Laser, Photodiode and solar cells, Tunnel, IMPATT & Gunn diodes and comparison of microwave devices.

PYL655 Laser Physics

3 Credits (3-0-0)

Pre-requisite(s): PYL560

Introduction. Physics of interaction between Radiation and Atomic systems including: Stimulated emission, emission line shapes and dispersion effects. Gain saturation in laser media and theory of Fabry-Perot laser. Techniques for the control of laser output employing

Q-switching, mode-locking and mode-dumping. Optical cavity design and laser stability criteria. Description of common types of conventional lasers. Physics of semiconducting optical materials, degenerate semiconductors and their Homo-junctions and Hetero-junctions. Light emitting diodes (LED's) junction lasers. Characteristics of diode laser arrays and applications.

PYL656 Microwaves

3 Credits (3-0-0)

Pre-requisite(s): PYL552

Maswell's equations, Wave equation, Boundary conditions, Ideal transmission line, Terminated line, Wave solutions, TEM, TE, and TM waves, Rectangular and circular wave guides, power and attenuation, Smith chart, Impedance matching, Double and triple stub tuners, Quarter wave and half wave transforms, Equivalent voltage and currents, Impedance description, Impedance, admittance and scattering matrix formulation, Signal flow graph, Attenuators, Phase shifters, Directional couplers, Junctions, Power dividers, Isolators and circulators, Resonant circuits, Transmission line resonators, Rectangular and circular wave guide resonators, Electron beams, Velocity modulation, Klystron, Magnetron, Traveling wave tubes, Gunn oscillator, Transistor and FET amplifiers, biasing, stability, power gain, noise, Mixers.

PYL657 Plasma Physics

3 Credits (3-0-0)

Pre-requisite(s): PYL552

Introduction to plasma, Debye shielding, Single particle motion in E and B fields, Mirror confinement, Plasma oscillations, Waves in unmagnetized plasmas, Solitons, Two stream instability, Rayleigh Taylor instability, Vlasov equation and Landau damping, Waves in magnetized plasmas (fluid theory), Plasma production & characterization, Plasma processing of materials, Laser driven fusion, Cerenkov free electron laser, Applications to astrophysics and astronomy.

PYD658 Mini Project

3 Credits (0-0-6)

PYL658 Advanced Plasma Physics

3 Credits (3-0-0)

Pre-requisite(s): PYL657

Nonlinearity and dispersion, solitary waves and solitons, Korteweg-deVries (kdv) equation, Electromagnetic (EM) radiation from free charges, Absorption of em waves in plasmas, Radiation by coulomb collisions, Plasma based Terahertz radiation generation, Hall thrusters, Rayleigh-Taylor instability, Resistive instability, Electron transport, Waveguide modes in the presence of plasma, Ponderomotive force, wakefield, Particle acceleration, Dusty plasma, Current flow in dust grains, Waves in dusty plasma.

PYL659 Laser Spectroscopy

3 Credits (3-0-0)

Review of lasers as spectroscopic source, Absorption spectroscopy, High sensitive methods, Cavity ring down spectroscopy, Doppler limited spectroscopy: Photo-ionization and Photo-acoustic spectroscopy, Laser-induced breakdown spectroscopy (LIBS), Laser induced fluorescence spectroscopy, Nonlinear spectroscopy: Linear and nonlinear absorption, saturation spectroscopy, Two-photon and multi-photon spectroscopy, Laser Raman spectroscopy: Stimulated Raman spectroscopy, Coherent anti-Stokes Raman spectroscopy (CARS), Time-resolved spectroscopy: Short pulse generation and detection, Life time measurements, Pump-and-probe techniques, Time-resolved absorption, Fluorescence and Raman spectroscopy, Applications of laser spectroscopy: Single molecule detection, Trace level detection of explosives and hazardous gases, LIDAR.

PYL701 Physical Foundations of Materials Science

3 Credits (3-0-0)

Overlap with : PYL303

Imperfections in solids: Point defects, thermodynamics of point defects. Dislocations: Grain Boundaries: Low and high angle grain

boundaries. Phase Transformations: Kinetics of phase transformations, homogeneous and heterogeneous nucleation, kinetic considerations of solid-state transformations. Diffusion: Diffusion Mechanisms, Steady and non-steady state diffusion, factors influencing diffusion. Phase Diagrams: Unary phase diagram, Gibbs Phase Rule, Binary Isomorphous Systems, Lever Rule, interpretation of phase diagrams, determination of phase amounts, Equilibrium and non-equilibrium solidification, Binary Eutectic Systems, Equilibrium Diagrams having intermediate phases or compounds, Eutectoid and Peritectic Reactions, Congruent Phase transformations, Ternary phase diagrams. Microstructural and Property changes in Iron-Carbon Alloys. Corrosion and degradation of materials: Electrochemical Corrosion of Metals, Galvanic cells, Corrosion rates, Corrosion reactions, passivation, types of corrosion, Mechanisms of oxidation, oxidation rates, corrosion control. Materials Selection and Design Considerations.

PYP701 Solid State Materials Laboratory-I

3 Credits (0-0-6)

This laboratory course is designed to make the students familiar with fundamental experiments related with materials synthesis and their primary characterization. Experiments are based on materials synthesis by solid-state reaction route, Spray-pyrolysis, spin and dip coating, thermal evaporation and sputtering, Dry and Wet Oxidation of Silicon, Understanding of binary eutectic phase diagrams, phase transitions, etc. and study of the optical, electrical, semiconducting and dielectric properties of the synthesized materials. Simulation experiments to understand the properties of solid state materials (e.g. ion-matter interaction, properties of low dimensional materials and band structure estimation) are also included.

PYL702 Physics of Semiconductor Devices

3 Credits (3-0-0)

Overlap with : PYL201

Charge carriers in semiconductors: Intrinsic and extrinsic semiconductors, position of Fermi energy level. Carrier transport phenomenon: Carrier drift and diffusion, Hall effect. Carrier generation and recombination.

PN junction: Energy band diagram, electrostatics of pn junction, PN junction current, ideal current-voltage relationship, junction breakdown mechanisms, heterojunctions. Metal-semiconductor contacts: Schottky barrier diodes, current transport in Schottky diodes, I-V characteristics, Ohmic contacts. MOS structure: Ideal MOS structure, energy band diagrams under accumulation, depletion and inversion conditions, C-V characteristics, various oxide charges in Si/SiO₂ MOS and their effect on C-V graph, MOSFET, basics about the operation of a MOSFET, I-V relationships of a MOSFET, non ideal effects. Optical devices: Basics of Solar cells and photodetectors.

PYP702 Solid State Materials Laboratory-II

3 Credits (0-0-6)

In this course, the emphasis is given on some advanced experiments related with materials characterization, such as X-ray diffraction, X-ray fluorescence, determination of transition temperature in a high temperature superconductor, frequency dependence of dielectric constants, Lock-in detection technique, Solar cells, Minority carrier life-time measurements, capacitance-voltage measurements on semiconductor devices, current-voltage characteristics of varistors, synthesis and electrical characterization of thermistors, disaccommodation factor in ferrites, scanning tunneling microscopy, ellipsometry, closed cycle refrigerator, etc.

PYL703 Electronic Properties of Materials

3 Credits (3-0-0)

Overlap with : PYL102

Drude and Sommerfeld theory of metals, Periodic Potential, Bloch's theorem, Kronig-Penney Model and Origin of bands, example of real band structure, Ferromagnetism, Molecular field theory, Exchange interactions, Band theory of ferromagnetism, Ferrimagnetism, Ferrites, Molecular field theory for ferrimagnets, Magnetic Domains, Type of Domain walls, Structure of domain walls, Soft and Hard magnetic materials, Spin waves, Magnon dispersion relation, Introduction to nanomagnetism, Dielectric constants of solids and

liquids, Clausius-Mossotti relation, dielectric dispersion and losses, piezo, ferro- and pyroelectricity, Optical constants, atomistic theory of optical properties, quantum mechanical treatment, band transitions, dispersion, plasma oscillations and excitons.

PYL704 Science and Technology of Thin Films

3 Credits (3-0-0)

Overlap with : PYL307

Kinetic theory of gases and basics of vacuum science and technology, Physical Vapor Deposition - Hertz Knudsen equation; mass evaporation rate; Knudsen cell, Directional distribution of evaporating species, Evaporation of elements, compounds, alloys, Raoult's law, Homogenous and Heterogeneous Nucleation, capillarity theory, atomistic and kinetic models of nucleation, basic modes of thin film growth, stages of film growth & cluster coalescence. E-beam beam evaporation, Molecular beam epitaxy and Pulsed Laser Deposition, Epitaxy-homo, hetero and coherent epilayers, lattice misfit and imperfections, epitaxy of compound semiconductors, scope of devices and applications, Glow Discharge and Plasma, Sputtering-mechanisms and yield, dc and rf sputtering, Bias sputtering, magnetically enhanced sputtering systems, reactive sputtering, Hybrid and Modified PVD- Ion plating, reactive evaporation, ion beam assisted deposition, Chemical Vapor Deposition - reaction chemistry and thermodynamics of CVD; Thermal CVD, Laser & plasma enhanced CVD, Atomic layer deposition, Electrodeposition, Spray pyrolysis.

PYL705 Nanostructured Materials

3 Credits (3-0-0)

Introduction and importance of nanostructured materials. Differences in the properties of bulk, nanoparticles, quantum dots, clusters, superlattices and nanostructured layers. Quantum confinement, surface enhanced properties, effective mass and tight binding approximations. Properties of 0D, 1D, 2D and superlattice structures. Plasmonic and optical properties of metal nanoparticles, Properties of magnetic nanoparticles, Structure and physical properties of nanomaterials. Chemical and physical methods for low dimensional growth with size control and size selection. Synthesis methods and growth mechanism for nanorods and nanowires. Growth and properties of graphene and other monolayer materials. Application of semiconductor, metal and magnetic nanoparticles. Application of nanostructures in catalytics, solar cell, resistive memory, thermoelectric, photoelectrochemical and sensor devices.

PYL707 Characterization Techniques for Materials

3 Credits (3-0-0)

Pre-requisite(s): PYL563 (for MSc), PYL114 (for UG)

Introduction to structure property correlation in materials, basic crystallography basic revision in 2-3 classes, k-space, X-ray diffraction, Reitveld refinement method and its fundamentals, Ewald sphere, Transmission electron microscopy in patterns, Microstructural investigations using Scanning electron microscope and Transmission electron microscopes, Kinetics of phase transformations in solids - Thermal analysis using differential thermal analysis and Differential scanning calorimetry, other techniques like Thermogravimetric analysis, Dynamic mechanical thermal analysis, Thin film DSC, Modulated DSC, Raman and Micro Raman spectroscopy, Photoluminescence spectroscopy, Material compositional analysis like Energy dispersive x-ray(EDX) and Electron probe micro analysis (EPMA).

PYL723 Vacuum Science and Cryogenics

3 Credits (3-0-0)

Overlap with : PYL301

Behavior of Gases; Gas Transport Phenomenon, Viscous, molecular and transition flow regimes, Measurement of Pressure, Residual Gas Analyses; Production of Vacuum - Mechanical pumps, Diffusion pump, Getter and Ion pumps, Cryopumps, Materials in Vacuum; High Vacuum and Ultra High Vacuum Systems; Leak Detection. Cryogenic Fluids - Helium 3, Helium 4, Superfluidity, Liquefaction of

Helium, Experimental Methods at Low Temperature: Closed Cycle Refrigerators, Cryostat systems based on He4 and He3, He3-He4 dilution refrigerator, Pomeranchuk Cooling, Magnetic Refrigerators, Thermoelectric coolers; Cryostat Design: Cryogenic level sensors, Handling of cryogenic liquids, Cryogenic thermometry.

PYL724 Advances in Spintronics

3 Credits (3-0-0)

Overlap with : PYL422 and PYL652

Spin dependent transport in magnetic metals - Anisotropic Magnetoresistance, Giant Magnetoresistance, Spin dependent tunneling, Tunneling magnetoresistance, Spin-Orbit interaction and Hall effects -Spin Hall Effect and Inverse Spin Hall Effect; Spin injection phenomena and applications - Spin Transfer Torque, Spin injection magnetization reversal; High frequency phenomena; Spin Transfer Torque applications, Dilute magnetic semiconductors, Spintronic properties of ferromagnetic semiconductors, Materials for Spin Electronics, Spintronic devices and their applications.

PYL725 Surface Physics and Analysis

3 Credits (3-0-0)

Surface structure, stability and reactivity, surface crystallography, surface stress, reconstructions and relaxation, surface sensitivity, clean surface preparation, physisorption, chemisorption, Langmuir, kinematics and dynamics of surface processes, properties of interfaces, adhesion and segregation, surface diffusion, chemical shift in electronic structure, surface states, plasmons, chemical potential/work function, experimental methods for surface structure: photoemission spectroscopy (PES), inverse photoemission spectroscopy (IPES), low energy electron diffraction (LEED), Reflection high energy electron diffraction (RHEED), Auger electron spectroscopy (AES), Secondary ion mass spectroscopy (SIMS), scanning tunneling microscopy (STM), Grazing incidence XRD, x-ray reflectivity (XRR), scanning electron microscope (SEM), electron energy loss spectroscopy (EELS), etc.

PYL726 Semiconductor Device Technology

3 Credits (3-0-0)

Silicon wafer fabrication and oxidation techniques, Growth kinetics and oxide measurement techniques, defects in silicon and silicon dioxide, interface defects, polysilicon, silicon nitride and silicide formation, Lithography and etching techniques, diffusion and ion implantation, modeling and measurement of dopant profile, Thick and thin film device technology, Processes involved in ink preparation, screen printing, laser trimming, mounting, mask making and packaging, Thin film deposition, metallization, etc.

PYL727 Energy Materials and Devices

3 Credits (3-0-0)

Importance of energy materials and devices in present technology. PV materials and devices: Definition and basic physical quantities; Energy band diagram and operation of Schottky, homojunction and heterojunction solar cells. Amorphous silicon and thin film based solar cell devices. Physics of tandem solar cell devices. New generation up conversion and down conversion devices. Materials for Si based solar cell, thin film solar cells, role of nanomaterials, dye sensitized solar cells. Introduction to PV panels, domestic and industrial applications. Materials and device concept for thermoelectric devices, Methods for improving the thermoelectric properties, application for heating and cooling applications. Operation of photoelectrochemical cell for hydrogen production, Energy band and materials requirements.

PYL728 Quantum Heterostructures

2 Credits (2-0-0)

Semiconductor heterostructures, Quantum confined systems, Electron transport in quantum structures, 2DEG, Excitons in quantum structures, Quantum confined Stark effect, Integer Quantum Hall effect, quantum well and quantum cascade lasers, quantum well infrared photodetectors (QWIPD), resonant tunneling devices (RTD), high electron mobility transistors (HEMT), quantum interference transistors (QIT) and hot electron transistors (HET).

PYL729 Nanoprobe Techniques

1 Credit (1-0-0)

Historical perspectives for invention of STM, Optical & Electron microscopy, Atom-scale tunnelling, Imaging atomic states, STM Instrumentation, Imaging modes, Constant current, Constant height, Feedback circuitry, surface topography, local density of the states, Single molecule vibrational spectroscopy, Image processing and analysis, Atomic Force Microscopy, Capacitance detection system, Optical detection systems, Imaging modes, Representative applications in biological sciences, Force Spectroscopy, Interpreting force curve, Adhesion, Nanoindentation, Magnetic Force Microscopy, Scanning Capacitance Microscopy, Thermal Methods at the Nanoscale, Dip-pen lithography, Near field Scanning Optical Microscopy, Hard X-ray nanoprobe.

PYL739 Computational Techniques for Solid State Materials

3 Credits (3-0-0)

Pre-requisite(s): PYL563/PYL114 or equivalent

Numerical solution of equations of motion, NVT molecular dynamics (MD), Application of MD for continuous and discontinuous potentials, Probability, Markov chains and master equations, Simple sampling by Monte Carlo (MC) methods, MC simulations for non-equilibrium and irreversible systems, Schrodinger Equation, The Born-Oppenheimer approximation, Wave-function based methods, Hartree theory, Hartree-Fock Theory, Density Functional Theory (DFT), Exchange Correlation Functional.

PYL740 Advanced Condensed Matter Theory

3 Credits (3-0-0)

Pre-requisite(s): PYL563/PYL114 or equivalent

Quantum Fields and their roles in describing collective modes. Particle creation and annihilation operators: Commutation relations for Bosons and Fermions. Second quantization. Equivalence with the many body Schroedinger Equation. Identical Conserved particles in equilibrium and thermodynamic properties, Simple Examples of Second Quantization, Bosonic and Fermionic systems. Cooper instability and BCS Hamiltonian, Mean field description of BCS condensate, Quasiparticle excitation and Bogoliubov de-Gennes theory. Phase transition and broken symmetry, Order parameter concept, Landau theory and Landau Ginzburg theory and some examples from condensed matter Spin systems and magnetism, Heitler London theory and Heisenberg model, Ferromagnets, Spin waves, Antiferromagnets, Spin-chains.

PYL741 Field Theory and Quantum Electrodynamics

3 Credits (3-0-0)

Quantization of free fields; Discrete symmetries; Gauge symmetries; QED; Elementary processes; Higher order effects; Renormalization; Novel effects of QED.

PYL742 General Relativity

3 Credits (3-0-0)

Overlaps with : PYL332

Brief review of special Relativity, Principle of equivalence: weak, strong and Einstein, Experimental evidence for equivalence principle of covariance, Curvilinear coordinates, Tensor algebra and tensor analysis, Parallel transport, Curvature tensor, Ricci and Einstein tensors, Einstein equation, The Schwarzschild metric, Shift in perihelion of planets, Bending of light ray, Modern tests with light delay, Gravitational lensing, Gravitational waves, and their detection, Friedmann-Robertson-Walker metric, the Hubble expansion.

PYL743 Group Theory and its Applications

3 Credits (3-0-0)

Concept of a group, multiplication tables, cyclic and permutation groups, subgroups, cosets, Isomorphism and Homomorphism, conjugate elements and classes, normal sub-groups and factor group, direct product of groups, Group representations, Unitary and Irreducible, representations, Schur's Lemmas, orthonormality theorems, Character

tables, Basis functions for irreducible representations. Continuous groups, Lie groups, The rotation group, Special orthogonal and unitary groups, crystallographic point groups and their representations. Applications in quantum mechanics and solid state physics.

PYL744 High Energy Physics

3 Credits (3-0-0)

Overlaps with : PYL433

Fundamental interactions; QED; QCD; Marshak-Sudarshan theory of weak interactions; Parity violation; Higgs mechanism; Glashow-Salam-Weinberg model; The standard model of particle physics; Open problems.

PYL745 Advanced Statistical Mechanics

3 Credits (3-0-0)

Pre-requisite(s): PYL558/PYL202/equivalent

Review of basic thermodynamics, Thermodynamic potentials, Equation of state. Theory of ensembles, Density matrix. Thermodynamics of phase transitions, Concept of thermodynamic stability, Metastability and instability, Vander Waal equation of state, Phase coexistence: and Gibbs phase rule. Lattice models to describe phase transition e.g. Ising model, Heisenberg model Landau theory of second order phase transitions, Scaling hypothesis, Critical exponents and universality classes, Spatial correlation, Correlation length, Importance of fluctuations near critical point. Mean Field theory, Transfer matrix method. Concept of renormalization group. Ising model, Renormalization in one dimension. Related numerical methods, Monte-Carlo simulations of spin systems.

PYL746 Non-equilibrium Statistical Mechanics with Interdisciplinary Applications

3 Credits (3-0-0)

Pre-requisite(s): PYL558/PYL202/equivalent

Review of equilibrium systems. Systems out of equilibrium, Kinetic theory of gases, Boltzman equation and its application to transport problems, Master equation and irreversibility. Time correlation functions, linear response theory, Kubo formula, Onsager relations. Random walks, Brownian motion and diffusion, Langevin equation, Fluctuation dissipation theorem, Einstein relation, Fokker-Planck equation. Some selected topics in ratchets, Driven diffusive systems. Fluctuation theorems, Jarzynski Equality. Percolation, Polymers, Soft condensed matter systems. Biological systems, Applications to Molecular motors, Stochasticity in gene expression. Stochastic growth models. Monte-Carlo simulations of Random walks and their applications to polymers, Percolation, Diffusion limited aggregation and other growth models.

PYL747 Non-linear Optics

3 Credits (3-0-0)

Pre-requisite(s): PYL560

Wave propagation in anisotropic media. Origin of optical nonlinearity, Nonlinear optical polarization; Second order and third order processes; Nonlinear optical wave equation; Second order nonlinear processes; Second harmonic generation, difference and sum frequency generation, Phase insensitive and phase sensitive optical parametric amplifiers, Spontaneous parametric down conversion; Birefringence and quasi phase matching; Optical parametric oscillators. Third order nonlinear processes; Third harmonic generation, Self phase modulation, Cross phase modulation and four wave mixing; Impact of nonlinear effects in lightwave communication systems; supercontinuum generation; Phase conjugation and applications, Stimulated Raman and Brillouin scattering; Applications of stimulated processes. Electro optic, photorefractive and acousto optic effects and their applications, Ultrafast and intense field nonlinear optics. Special topics.

PYL748 Quantum Optics

3 Credits (3-0-0)

Pre-requisite(s): PYL556/PYL122

HBT effect, Quantization of the EM field, Quantum states of light,

correlation functions, Detection of quantum light and techniques, coincidence-counting, Phase-sensitive detection, Quantum treatment of linear optics, Quantum light by non-linear optical processes, SPDC, Signatures of quantum behaviour, Landmark experiments in quantum optics, Applications: Laser cooling and BEC, Ion trapping, CPT, EIT, Slow light, Introduction to quantum communication: Quantum teleportation, Entanglement swapping, Quantum repeaters, Quantum cryptography.

PYL749 Quantum Information and Computation

3 Credits (3-0-0)

Basic classical and Quantum mechanics; Basic information theory; Bits, Qubits and ebits; Non-locality and entanglement; Quantum gates and circuits; Teleportation, Superdense coding, Quantum oracles; Quantum algorithms; Quantum encryption; Quantum error correction; Quantum computers.

PYL751 Optical sources, photometry and metrology

3 Credits (3-0-0)

Eye and vision: Visual system, Sensitivity, Acuity; Radiometry and Photometry: Radiometric quantities and their measurements, Photometric quantities, Radiation from a surface; Brightness and luminous intensity distribution; Integrating sphere; Illumination from a line, Surface and volume sources; Colorimetry: Fundamentals, Trichromatic specifications, Colorimeters, CIE system; Conventional light sources: Point and extended sources; Incandescent, fluorescent, discharge lamps; LEDs; Lighting fundamentals, Optical detectors; Detector characteristics, Noise considerations, Single & multi-element detectors, CCDs.

Optical metrology: Surface inspection, Optical gauging and profiling, Techniques for non-destructive testing, Moire self imaging and Speckle metrology, Sensing elements.

PYL752 Laser systems and applications

3 Credits (3-0-0)

Review of Laser theory, properties of laser radiation, and laser safety; CW lasers systems: Ruby-, Nd: YAG- and Nd: Glass lasers, DPSS lasers, Fiber lasers, Gas lasers, Pulsed lasers: ns, ps, and fs lasers, Excimer-, dye-, X-ray- and Free-electron lasers; Semiconductor lasers: DH, QW, QCL, VCSEL, DFB- and DBR lasers; Application of lasers in data storage, communication and information technology; Laser applications in optical metrology; Surface profile and dimensional measurements; Laser Applications in material processing and manufacturing; 3D-printing, Marking, Drilling, Cutting, Welding, Hardening and Manufacturing; Laser Doppler velocimetry, LIDAR, laser spectroscopy, LIF, LIBS, Bio-medical applications of lasers, Laser tweezers and applications, Laser applications in defence.

PYL753 Optical systems design

3 Credits (3-0-0)

Gaussian theory of optical system; Aberrations: Transverse ray and wave aberrations; Chromatic aberration; Third order aberrations; Position and shape factors; Meridional ray tracing; Paraxial rays and first order optics; Primary chromatic aberration: Achromat doublet, Triplet and dialyte, tolerances, Chromatic aberration at finite aperture; Spherical aberration: Surface contribution formulas; Spherically corrected achromat; Oblique pencils: Tracings of oblique meridional and skew rays; Coma and Abbe Sine Condition; Image evaluation: Geometric OTF, Strehl ratio, Spot diagram; definition of Merit function; Cooks Triplet and its derivatives; Double Gauss lens, Introduction to Zoom lenses and Aspherics, Examples of modern optical system, GRIN optics.

PYL755 Basic optics and optical instrumentation

3 Credits (3-0-0)

Ray optics, wave optics and E.M. wave optics, Reflection and refraction of plane waves and by spherical surfaces; Lens aberrations; Polarization and Polarizing components; Diffraction: Diffraction by single and multiple slits and circular aperture, Gaussian beams, Interference: Two beam and multiple beam interference.

Interferometers: Shearing and Scanning interferometers, Interferometric

instrumentation for testing, Polarization interferometers; Spectroscopic instrumentation, Fourier transform spectroscopy; Imaging and super resolution imaging, near-field imaging techniques; Adaptive optics; Wavefront sensing and correction, reconstruction, Opto-medical instruments; Optical coherence tomography, Infrared instrumentation; I.R. telescopes, Focal plane arrays; Light field camera, Space optics; Satellite cameras, High-resolution radiometers, Space telescopes, Space based sensors.

PYL756 Fourier optics and holography

3 Credits (3-0-0)

Signals and systems, Fourier Transform(FT), Sampling theorem; Diffraction theory; Fresnel-Kirchhoff formulation and angular spectrum method, brief discussion of Fresnel and Fraunhofer diffraction, FT Properties of lenses and Image formation by a lens; Frequency response of a diffraction-limited system under coherent and incoherent illumination, OTF-effects of aberration and apodization, Comparison of coherent and incoherent imaging, Super-resolution; Techniques for measurement of OTF; Analog optical information processing: Abbe-Porter experiment, phase contrast microscopy and other simple applications; Coherent image processing: Vander Lugt filter; Joint-transform correlator; Pattern recognition, Synthetic Aperture Radar.

Basics of holography, in-line and off-axis holography; transmission and reflection holograms, Amplitude and phase holograms, Recording materials. Thick and thin holograms.

PYL757 Statistical and Quantum optics

3 Credits (3-0-0)

Overlaps with : PYL748

Probability theory, Generating function, Characteristic function; Analytic signal representation, Correlation and spectral properties, Temporal, spatial and partial coherence, Law of interference, spectral interference, Coherent mode representation, Propagation of coherence; Higher order correlations; Photodetection probability, Mandel's photon counting formula; Intensity interferometry, Speckle statistics and applications, Field quantization, Number states, Coherent states, Glauber-Sudarshan representation, Tests for non-classicality, Quantum correlations, Two photon coherence function and coincidence count rate, Quantum treatment of beamsplitter and simple interferometers.

PYL758 Advanced Quantum optics and applications

3 Credits (3-0-0)

Pre-requisite(s): PYL757

Quantization of the EM field, Quantum states of light, Correlation functions, Photodetection techniques, Generation of quantum light, Detection of quantum light, coincidence-counting, Phase-sensitive detection, Quantum treatment of linear optics, Quantum light by non-linear optical processes, Signatures of quantum behaviour, Squeezed states and applications, Landmark experiments in quantum optics, Light-matter interaction, Quantum memories, Experimental quantum communications : Quantum teleportation, Entanglement swapping, Quantum repeaters.

PYL759 Computational optical imaging

3 Credits (3-0-0)

Revision of Fourier optics and basic concepts in optical imaging, Mathematical preliminaries on inverse problems in imaging, Compressive imaging, Multi-view imaging systems, Point-spread function engineering, Phase retrieval, Interferometric imaging methods such as digital holography and optical coherence tomography, Imaging through turbulent media, Super-resolution through structured illumination, Correlation/Ghost imaging.

PYL760 Biomedical optics and Bio-photonics

3 Credits (3-0-0)

Introduction to Biophotonics: Photobiology: Light-tissue interactions and light induced effects in Biological systems. Optical properties

of tissue – absorption, scattering, diffraction, and emission. Spectroscopy: Fluorescence, Raman and diffuse reflectance spectroscopy: Physics and their applications. Basic principles of optical imaging and spectroscopy systems. Principles of standard optical microscopy/fluorescence microscopy/ endoscopy and instrumentation. Confocal microscopy: Principles, instrumentation and applications. Two-photon and multi-photon microscopy. Physics of optical tweezers and its applications in biology. Bio-medical applications of lasers: Laser scissors, Photo-dynamic therapy. Optical coherence tomography (OCT): Physics, Imaging concepts and applications. Photo-acoustic tomography (PAT): Physics, Imaging concepts and applications. Quantitative phase microscopy; Principles and imaging concepts, Imaging beyond diffraction limit; SIM, STED, NSOM, Image processing and image recovery methods.

PYL761 Liquid Crystals

3 Credits (3-0-0)

Nematic, Cholesteric, Smectic and Ferro-electric liquid crystals, Landau-de Gennes and Frank-Oseen free energy, Nematic-isotropic phase transition, Landau theory and Maier-Saupe theory, Kerr effect, Pockel effect, Polarizing Microscopy, Differential Scanning calorimetry, Dielectric Spectroscopy, Bent core liquid crystals, Twist bent liquid crystals, Display applications.

PYP761 Optical fabrication and metrology laboratory

3 Credits (0-0-6)

Trepanning, Grinding, Curve generation, Smoothing and polishing, Centering and Edging, Optical coating, Autocollimator, Newton interferometer, Twyman-Green interferometer, Shack Hartmann Sensor and Moire, Talbot interferometry for measurement of optical performance parameters of the optical elements, Spherometers, Abbe refractometer, White light, Fabry-Perot interferometers.

PYL762 Statistical Optics and Optical Coherence Theory

3 Credits (3-0-0)

Review of probability and random variables. Probability and Statistics in Optics. Stochastic processes to represent optical fields. Ergodicity and stationarity, Auto-correlation, cross-correlation, and Wiener-Khinchin theorem, Gaussian and Poisson random processes. First-order properties of optical fields: Radiation from sources of any state of coherence. Monochromatic, polychromatic and broad light sources. Polarized, partially polarized and unpolarized thermal light and pseudo-thermal light. Second-order coherence theory in space-time domain: Temporal coherence and complex degree of self coherence. Spatial coherence and complex degree of mutual coherence, Cross-spectral density, propagation of mutual coherence, The Van Cittert-Zernike theorem and its application to stellar interferometry. Higher-order coherence theory: Hanbury-Brown and Twiss experiment, Intensity-intensity correlation and Ghost imaging. Second order coherence theory in space-frequency domain: Concept of cross-spectral density, spectral degree of coherence, Wiener-Khintchin theorem, Electromagnetic coherence, Degree of polarization and applications. Applications of second-order coherence theory: Optical coherence tomography, stellar interferometry, Laser speckle and speckle metrology, Fourier transform spectroscopy, Partial coherence in imaging systems, Propagation through random inhomogeneous media.

PYP762 Advanced optics laboratory

3 Credits (0-0-6)

Experiments related to recording and development of holograms, Laser Speckles, Fresnel hologram, Reflection and Rainbow hologram, Polarization, Spatial filtering, Digital holography, Optical security systems, Optical singularity, Nonlinear optical processes, Tomography, Profilometry, Polarizing microscope, Strain viewer.

PYP763 Computational Optics laboratory

3 Credits (0-0-6)

Pre-requisite(s): PYL756

Ray tracing in optical systems with commercial software, Image

handling in MATLAB or similar environment for optics experiments, Simulation of Fresnel and Fraunhofer diffraction, Fourier transforms and applications in optics, Simulation of spatial filtering, Matched filtering and pattern recognition, Simulation of Joint Transform and Vander Lugt correlators, Synthesis of computer generated hologram and optical reconstruction, Simulation of recording and reconstruction of digital holograms, Interferogram analysis using Fourier and Phase shifting methods, Stokes parameters of optical beams and plotting of polarization ellipse, Simulation of Multi-beam interference for Photonic Crystal Designs, Design Project.

PYP764 Advanced Optical Workshop

3 Credits (0-0-6)

Development of metal optics, Infrared imaging, Fabrication of Total Internal Reflection Prisms, Measurement of thin coating, Fabrication of Shearing plate, Shearing interferometry, Talbot interferometry, Moire interferometry.

PYL770 Ultra-fast optics and applications

3 Credits (3-0-0)

Overlaps with : PYL412

Generating and measuring Ultrashort Optical Pulses, Ultra-Broadband Optical Parametric Amplifiers, Advances in Solid-State Ultrafast Laser Oscillators, Ultrafast Quantum Control in Atoms and Molecules, Femtosecond Optical Frequency Combs, Ultrafast Material Science Probed using Coherent X-Ray Pulses from High-Harmonic Generation, Ultrafast Nonlinear Fibre Optics and Supercontinuum Generation, Nonlinear Wavelength Conversion and Pulse Propagation in Optical Fibres, Applications of Ultra-Intense, Short Laser Pulses, Utilising Ultrafast Lasers for Multiphoton Biomedical Imaging, Femtosecond Laser Micromachining, Technology and Applications of THz waves, Ultrafast Nonlinear Microscopy, Attosecond Generation.

PYL771 Green Photonics

3 Credits (3-0-0)

Need for green photonics, Overview of solid-state lighting technologies and their advantages. Inorganic and Organic LEDs: Fundamentals, Device Physics, Diode structures and operating principles. Materials for LEDs, OLEDs and PLEDs: Phosphor materials and their characterisation. LEDs and OLED fabrication, encapsulation and Packaging techniques. Electro-optical properties of LEDs and OLEDs; Electric drive circuits, internal, external and power efficiency, Spectral distribution, and encapsulants. Design and development of light out-coupling techniques. Photometry and colorimetry of LEDs and OLEDs. Free-form optics and design of LEDs and OLEDs based illumination systems: General lighting, Traffic lights, Automotive, Street & flood lighting, and Backlights for displays.

Sunlight Harvesting Technologies, Non-imaging Solar Concentrators and illuminators: Parabolic and Fresnel lens, Diffractive, Micro-optics and Free-form optics for lighting and illumination engineering of day light saving, light guiding devices and diffuse lighting materials and devices.

Solar photovoltaics: Inorganic, Organic and Polymeric solar cells: Principles, Technology and Applications. Role of solar concentrators.

PYL772 Plasmonic sensors

3 Credits (3-0-0)

Optical fiber, optical fiber sensors, characteristics and components of optical fiber sensors, Spectroscopic techniques, Modulation schemes; Physics of plasmons, Surface plasmons at semi-infinite metal-dielectric interface, Excitation of Surface plasmons, surface plasmon resonance (SPR) condition, Interrogation techniques; Theory of SPR based optical fiber sensors, N-layer model, excitation by meridional rays: on axis excitation, performance parameters: sensitivity, detection accuracy and figure of merit; SPR based sensing applications, refractive index and other analytes sensing, multichannel sensing, multianalyte sensing; Factors affecting performance of the sensor: fiber parameters, change of metal, high index dielectric material, probe design, Temperature and ionic fluid.

PYL780 Diffractive and micro optics

3 Credits (3-0-0)

Diffractive optics, Micro optics, Design of diffractive optics, Amplitude and Phase Diffractive Optics, Application of Diffractive optics, Fabrication of Diffractive and micro optics, Photo-Lithography, Interferometric, profilometric and other testing techniques for Diffractive optics, Plastic optics, Injection Moulding of plastic optics, Applications of Micro optics in Beam shaping, MOEMS, Optical information technology and Aspheric optics, Freeform optics.

PYL790 Integrated Optics

3 Credits (3-0-0)

Guided TE and TM Modes of Symmetric and Asymmetric Planar waveguides: Step-index and graded-index waveguides. Strip and channel waveguides, anisotropic waveguides, Marcattili's Method, Effective-Index method and Perturbation method of analysis. Directional couplers, Coupled mode analysis of uniform and reverse delta-beta couplers. Applications as power splitters, Y-junction, optical switch; phase and amplitude modulators, filters, A/D converters, Y-splitters, Mode splitters, polarization splitters; Mach-Zehnder interferometer based devices, Acoustooptic waveguide devices. Arrayed waveguide devices, Nano-photonic-devices: Metal/dielectric plasmonic waveguides, Long and short range surface Plasmon modes supported by thin metal films, Applications in waveguide polarizers and bio-sensing. Fabrication of integrated optical waveguides and devices. Waveguide characterisation, End-fire and prism coupling; grating and tapered couplers, Fiber pigtailing, Nonlinear effects in integrated optical waveguides.

JOP791 Laboratory-I (Fiber Optics and Opt. Comm. Lab)

3 Credits (0-0-6)

Experiments on characterisation of optical fibers, sources, detectors and modulators, in the Physics Department and experiments on electronics and communication in the Electrical Engineering Department.

PYL791 Fiber Optics

3 Credits (3-0-0)

Overlaps with : PYL413 and PYL650

Rays and ray paths in optical fibers; Numerical aperture; Step index and graded index fibers; Attenuation in optical fibers; Modal analysis of symmetric planar waveguides; TE and TM modes, mode cutoff, power flow: Linearly polarized (LP) modes in step-index optical fibers; Mode cutoff, single mode operation; Mode field diameter in single mode fibers, LP modes of infinitely extended parabolic medium, Intermodal dispersion in multimode fibers; Optimum profile fibers; Dispersion and chirping of pulses in single mode fibers, Dispersion compensation and dispersion tailoring; Birefringence in optical fibers, Polarization mode dispersion; Specialty fibers: Birefringent fibers, Photonic crystal fibers; Erbium doped fiber amplifiers and lasers; Fiber optic components: fiber Bragg gratings, directional couplers; Fiber fabrication and characterization techniques; OTDR, connectors and splices.

JOP792 Laboratory-II (Fiber Optics and Opt. Comm. Lab)

3 Credits (0-0-6)

Experiments on characterisation of optical fibers, sources, detectors and modulators, in the Physics Department and experiments on electronics and communication in the Electrical Engineering Department.

PYL792 Optical Electronics

3 Credits (3-0-0)

Light propagation through anisotropic media; Electro optic effect and electro optic modulators and switches; Liquid crystal devices and spatial light modulators, Acousto optic effect, acousto optic tunable filter, acousto optic deflector, scanner and spectrum analyser; Basics of nonlinear optical effects; Second harmonic generation, phase matching, quasi phase matching, Sum and difference frequency

generation, parametric amplification and parametric oscillation; Third order nonlinear optical effects, Self phase modulation and soliton formation, Cross phase modulation and four wave mixing; Stimulated Raman and Brillouin scattering; Nonlinear effects in optical fibers.

JOL793 Selected Topics-I

3 Credits (3-0-0)

PYL793 Photonic Devices

3 Credits (3-0-0)

Overlaps with : PYL312

Review of Semiconductor Physics for Photonics: The Density of States $\rho(k)$ and $\rho(E)$; Density of States in a Quantum Well Structure; Carrier Concentration & Fermi Level; Quasi Fermi Levels. Semiconductor Optoelectronic Materials; Heterostructures, Strained-Layers, Bandgap Engineering; p-n junctions; Schottky Junctions & Ohmic Contact.

Interaction of Photons with Electrons and Holes in a Semiconductor; Rates of Emission and Absorption; Amplification by Stimulated Emission; The Semiconductor Optical Amplifier. Quantum Confined Stark Effect and Franz-Keldysh Effect. Electro-absorption Modulator: Principle of Operation and Device Configuration. Light Emitting Diode: Device Structure and Output Characteristics, Modulation Bandwidth, Materials for LED, and Applications. White light LEDs.

Laser Diodes: Device Structure and Output Characteristics, Single Frequency Lasers; DFB, DBR Lasers, VCSEL, Quantum Well and Quantum Cascade Laser, Micro-cavity lasers. Modulation of Laser Diodes, Practical Laser Diodes & Handling. Photodetectors: General Characteristics of Photodetectors, Impulse Response, Photoconductors, PIN, APD, Array Detectors, CCD, Solar Cell. Photonic Integrated Circuits.

JOL794 Selected Topics-II

3 Credits (3-0-0)

JOS795 Independent Study

3 Credits (0-3-0)

Detailed study on a contemporary topic in the area of Optoelectronics/Optical Communication, as suggested by the Course Coordinator.

PYL795 Optics and Lasers

3 Credits (3-0-0)

Overlaps with : PYL115, PYL311, PYL560 and PYL655

Review of basic optics: Reflection and refraction of plane waves; Polarization and polarizing devices; Diffraction: diffraction due to single slit and circular aperture, grating, Gaussian beam; Interference: two beam and multiple beam interference, Fabry-Perot interferometer, Michelson interferometer; Fourier optics and its applications, spatial frequency filters.

Interaction of light with matter, light amplification and oscillation, Laser rate equations, three level and four level systems, Line broadening mechanisms, Laser power around threshold, Optical resonators and resonator stability, Modes of a spherical mirror resonator, mode selection, Q-switching, mode locking in lasers, properties of laser radiation, laser systems and some applications of lasers.

JOV796 Selected Topics in Photonics

1 Credit (1-0-0)

PYL800 Numerical and Computational Methods in Research

3 Credits (3-0-0)

Solution of polynomial and transcendental equations, ordinary differential equations with initial conditions, matrix algebra and simultaneous equations, eigenvalues and eigenvectors of a real symmetry matrix, least square curve fittings, numerical integration, integral equations, ordinary differential equation with boundary conditions, Monte Carlo methods and random numbers.

JOD801 Major Project Part-I

6 Credits (0-0-12)

Analysis/Design/Simulation/Experimental study on topics in the board area of Optoelectronics and Optical Communication, offered by the faculty.

JOD802 Major Project Part-II

12 Credits (0-0-24)

Detailed investigations on the study of contemporary topics in the board area of Optoelectronics and Optical Communication. Normally this is a follow-up of the study carried out under Part-1 of the Major Project.

PYD801 Major Project Part-I

6 Credits (0-0-12)

Study on topics in the board area of Solid State Materials, offered by the faculty.

PYD802 Major Project Part-II

12 Credits (0-0-24)

Detailed investigations on the study of contemporary topics in the board area of Solid State Materials. Normally this is a follow-up of the study carried out under Part-1 of the Major Project.

PYD851 Major Project Part-I

6 Credits (0-0-12)

Study on topics in the board area of Applied Optics, offered by the faculty.

PYD852 Major Project Part-II

12 Credits (0-0-24)

Detailed investigations on the study of contemporary topics in the board area of Applied Optics. Normally this is a follow-up of the study carried out under Part-1 of the Major Project.

PYS855 Independent Study

3 Credits (0-3-0)

PYL858 Advanced Holographic techniques

3 Credits (3-0-0)

Basic concepts in holography, Holographic displays and stereograms, Image holograms, White light, Rainbow holograms, Color holograms, Volume holograms, Diffraction efficiencies, Fourier Transform holograms, Pattern recognition, Correlators. Computer generated holography, Digital holography and its applications: Holographic interferometry, Holographic contouring, NDT of engineering objects, Optical testing, HOEs, Particle sizing, holographic Particle Image Velocimetry, Microscopy, Interferometry, Imaging through aberrated media, phase amplification by holography, Multifunction elements, diffusers, interconnects, couplers, scanners, Optical data storage, optical data processing, holographic solar concentrators, Associative memory.

PYL879 Selected Topics in Applied Optics

3 Credits (3-0-0)

PYV881 Selected Topics-I

1 Credit (1-0-0)

PYV882 Selected Topics-II

1 Credit (1-0-0)

PYD883 Minor Project

3 Credits (0-0-6)

PYL891 Fiber Optic Components and Devices

3 Credits (3-0-0)

Pre-requisite(s): PYL413 or PYL650 or PYL791

Review of optical fiber properties: step and graded index fibers, multimode, single mode, birefringent, photonic crystal and holey fiber: Directional couplers: Analysis, fabrication and characterization: Fused and polished fiber couplers application in power dividers, wavelength division multiplexing, interleavers and loop mirrors: Fiber half-block devices and application in polarizers, and wavelength filters. Fiber grating: Short and Long period gratings, Analysis, fabrication and characterization: application in add-drop multiplexing, gain flattening, dispersion compensation and wavelength locking and sensing. Polarization effects in Optical fibers, Fiber polarization components: Fiber optic wave-plates, polarization controllers and associated micro-optic components like isolators and circulators; Optical fiber sensors: Intensity, phase, polarization and wavelength-shift based sensors, applications in various disciplines.

PYL892 Guided Wave Photonic Sensors

3 Credits (3-0-0)

Pre-requisite(s): PYL413 or PYL650 or PYL790 or PYL791

Review of propagation characteristics of single and multimode optical Fibers and Integrated optical Waveguides. Surface plasmon modes supported by a single metal/dielectric interface and metal/dielectric waveguides. Fiber Optic Sensors: Intensity, phase, polarization and wavelength modulation schemes. Intensity based sensors: using microbends and tapers in multimode fibers, Mach-Zehnder interferometer sensors, Fiber Optic gyroscope, Fiber optic current sensor, Photonic crystal based sensors. Sensors based on Bragg and Long period gratings in Fiber and integrated optical waveguides, Sensors based on modal interference: Applications in temperature, strain and refractive index sensing. Distributed Sensors based on Raman and Brillouin Scattering. Surface Plasmon Resonance (SPR) bio-sensors based on Kretschman and Otto configurations, coupling with optical fiber modes, Grating coupled, Localised SPR, Plasmonic nanoparticles, interferometry. Signal processing, Noise factors in sensors and sensor networking.

Department of Textile and Fibre Engineering

TXL130 Polymer Chemistry

3 Credits (3-0-0)

The course will deal with chain and step growth polymerization methods, polymer's macromolecular architecture, molecular weight of polymers, copolymerization, cross-linked polymers, general structure and characteristics of polymers, properties of fiber forming polymers and their applications.

TXL111 Textile Fibres

3 Credits (2-0-2)

Classification of fibres. Basic structure of a fibre. General properties of a fibre such as moisture absorption, tenacity, elongation, initial modulus, yield point, toughness, elastic recovery. Relationship between polymer structure and fiber properties. Detailed chemical and physical structure of natural fibres: cotton, wool and silk, their basic properties. Introduction to important bast and leaf fibres. Basic introduction to Fibre spinning. Introduction Manmade and synthetic fibres: Viscose, Acetate, Acrylic, Nylon, polyester. High Performance Fibres.

Laboratory exercises would include experiments on fibre identification through physical appearance, microscopic (optical, SEM), and burning behaviour. Chemical identification through solvent treatment and elemental analysis.

TXL211 Structure and Physical Properties of Fibres

3 Credits (3-0-0)

Pre-requisite(s): TXL130

Molecular architecture. Configuration. Conformation. Amorphous and crystalline phases. Glass transition. Crystallization. Melting. Structures in natural and synthetic fibres. Characterization techniques. Fibre properties. Moisture absorption properties. Mechanical properties. Fibre friction. Optical properties. Thermal properties.

TXL212 Manufactured Fibre Technology

3 Credits (3-0-0)

Pre-requisite(s): TXL211

Polymer rheology in shear as well as extension. Polymer entanglements. Flow instabilities in polymer fluids. Principles of solidification. Heat and mass transfer. Melt spinning. Force and momentum balance in spinline. Stress induced crystallization. Experimental observations from melt spinning of polyamides and polyesters. Solution spinning. Dry and wet spinning. Transport phenomena. Kinetic and thermodynamic effects in solution spinning. Solution spinning of viscose and acrylic fibres. Dry jet wet spinning. Post spinning processes. Drawing and heat setting. Stress-strain-structure relationship. Effect of post spinning operations on fibre structure and properties. Spin finish applications. Introduction to electrospinning.

TXP212 Manufactured Fibre Technology Lab

1 Credit (0-0-2)

Pre-requisite(s): TXL212

The laboratory experiments are planned to provide knowledge on fibre formation of selected synthetic polymers and the characterization of fibres/tapes produced. Melt-spinning, extrusion, wet spinning and dry-jet wet spinning techniques is used to produce fibres or tapes. The evaluation of structure through thermo-mechanical properties, polymer solution rheology and microscopic analysis of materials is carried out using established methods.

TXL221 Yarn Manufacture-I

3 Credits (3-0-0)

Pre-requisite(s): TXL111

Impurities in natural fibres. Separation of trash and lint. Pre-baling operations for staple fibres. Purpose of opening, cleaning, mixing and blending of fibres. Blow room machinery and operating elements. Principles of fibre opening and cleaning in blow room. Transportation of fibre mass. Influence of process parameters on opening and cleaning. Analysis of opening and cleaning processes. Principles and

methods of fibre mixing and blending. Principles of carding. Machine elements and operations in card. Sliver formation, Sliver packaging, fibre configurations in sliver. Objectives, principles and methods of roller drafting. Purpose and principle of condensation of fibres. Causes of mass variation of sliver and control. Automation and recent developments in blowroom, card and draw frames. Fibre opening, carding and drawing for wool, jute and other fibres. Modification in process parameters for processing blended fibres in blowroom, card and drawframe.

TXP221 Yarn Manufacture Laboratory-I

1 Credit (0-0-2)

Pre-requisite(s): TXL111

Experiments related to the lecture course entitled "Yarn Manufacture I (TXL221)".

TXL222 Yarn Manufacture-II

3 Credits (3-0-0)

Pre-requisite(s): TXL221

Fibre fractionation and combing. Preparation of fibre assembly for combing. Principle of operations of a rectilinear comber. Combing machine elements. Timing diagram theory of fibre fractionation. Roving formation: Elements of roving frame, drafting, twisting and winding in roving frame, principle and mechanism of builder motion in roving frame. Yarn formation: Elements of ring frame, drafting, twisting and winding in ring frame, design aspects of spindles, rings and travellers, builder motion in ring frame. Spinning geometry. Twist and yarn strength. Yarn doubling : Purpose of doubling and plying of yarns, ring doubling, two-for-one and three for one twisting. New spinning methods: Principles of yarn formation in rotors, friction, airjet, and vortex spinning. Yarn structure and property comparison.

TXP222 Yarn Manufacture Laboratory-II

1 Credit (0-0-2)

Pre-requisite(s): TXP221

Experiments related to the lecture course entitled "Yarn Manufacture II (TXL222)".

TXL231 Fabric Manufacture-I

3 Credits (3-0-0)

Pre-requisite(s): TXL111

Introduction to various fabric forming principles: weaving, knitting, nonwoven and braiding. Stages of woven fabric manufacturing: winding, warping, sizing, drawing and tying in and weaving. Winding: principles, precision and random winding, digicone winding, yarn tensioning and clearing. Warping: direct and sectional warping. Sizing: size materials, sizing machines, process and quality control, modern trends. Drawing and tying in. Basic fabric designs: plain, matt, rib, twill and satin, drafting and lifting plans. Primary motions of shuttle looms: cam shedding, cam designs, dobby and jacquard systems, picking systems, loom timing, beat up, sley eccentricity. Secondary and auxiliary motions: take up, let off, warp and weft stop and warp protecting motions.

TXP231 Fabric Manufacture Laboratory-I

1 Credit (0-0-2)

Pre-requisite(s): TXL111

Experiments related to the theoretical paper TXL231.

TXL232 Fabric Manufacture-II

3 Credits (3-0-0)

Pre-requisite(s): TXL231

Shuttleless looms: Principles of weft insertion in projectile, rapier, air-jet and water-jet looms, comparison of various weft insertion systems, principles of two phase, multiphase, circular and narrow fabric weaving. Leno weaving, Triaxial weaving, different types of selvages, common fabric defects, Knitting: Basic weft and warp knitted

constructions, cams and needles, different weft and warp knitted structures and their properties, weft and warp knitting machines. Nonwovens: Definitions and classifications, production technology, selection criteria and important properties of fibres used, different types of web information and bonding techniques, production and properties of needle punched, adhesive bonded, thermally bonded, hydroentangled, spun bonded and meltblown fabrics. Braided structures: Types of braiding processes, classification of braids, braid geometry, structure-property relationship, over braiding.

TXP232 Fabric Manufacture Laboratory-II

1 Credit (0-0-2)

Pre-requisite(s): TXP231

Experiments related to the theoretical paper TXL232.

TXL241 Technology of Textile Preparation & Finishing

3 Credits (3-0-0)

Pre-requisite(s): TXL111

Natural and added impurities in textiles. Singeing, desizing, scouring, bleaching, mercerisation and optical whitening of cotton. Combined preparatory processes Carbonisation, scouring and bleaching of wool, degumming of silk. Preparation of synthetic fibres and blends, heat setting. Machinery for preparation of textiles. Surfactants and their application. Introduction to chemical and mechanical finishes. Chemical finishes for hand modification. Biopolishing, easy care, oil, water and soil repellent finishes. Fire retardancy, antimicrobial finishes. Finishes for wool. Mechanical finishes like shrink proofing and calendaring; Raising, sueding and emerising. Low liquor application techniques and machinery; Stenters and dryers.

TXP241 Technology of Textile Preparation & Finishing Lab

1.5 Credits (0-0-3)

Pre-requisite(s): TXL111

Natural and added impurities in textiles. Singeing, desizing, scouring, bleaching, mercerization and optical whitening of cotton. Combined preparatory processes Carbonization, scouring and bleaching of wool, degumming of silk. Chemical finishes for hand modification. Bio-polishing, Resin finishing, Water and Oil repellent finishes. Fire retardant finish, Antimicrobial finish, Weight reduction of cotton.

TXL242 Technology of Textile Coloration

3 Credits (3-0-0)

Pre-requisite(s): TXL241

The principles of dyeing and printing of textile materials. Basic characteristics of dyes, chemical structure of dyes, and classification of dyes. Dyeing equipment and the specific dyes and procedures used to dye textiles. Evaluation of Fastness. Methods of printing namely, roller, screen, transfer, ink jet and the preparation of printing paste. Direct, discharge and resist printing styles. Physical chemistry of fibre/fabric dyeing. Physicochemical theories of the application of dyestuffs to textile and related materials, including the thermodynamics and kinetic principles involved.

TXP242 Technology of Textile Coloration Lab

1.5 Credits (0-0-3)

Pre-requisite(s): TXL241 and TXP241

The principles of dyeing and printing of textile materials. Dyeing equipment and the specific dyes and procedures used to dye textiles. Evaluation of Fastness. Methods of printing namely, screen, transfer, ink jet and the preparation of printing paste. Direct, discharge and resist printing styles.

TXD301 Mini Project

3 Credits (0-0-6)

Pre-requisite(s): TXL211/TXL221/TXL222/TXL231/TXL232 and EC65

TXR301 Professional Practices

2 Credits (0-1-2)

Pre-requisite(s): TXL211/TXL221/TXL222/TXL231/TXL232 and EC65

TXS301 Independent Study

3 Credits (0-3-0)

Pre-requisite(s): EC65

TXL321 Multi and Long Fibre Spinning

3 Credits (3-0-0)

Pre-requisite(s): TXL222

Blending of fibres during staple fibre spinning, Characteristics of manmade fibres and their spinnability. Blending at draw frame. Fundamentals of strictly similar yarns. Processing of manmade fibres and blends on staple fibre spinning system. Properties of blended yarns. Spinning of dyed fibres. Mélange yarns. Worsted / semi-worsted/Woolen spinning. Jute and Flax Spinning. Tow to top Conversion. Bulk yarn. Spun silk yarn.

TXL331 Woven Textile Design

3 Credits (3-0-0)

Pre-requisite(s): TXL232

Elements of woven design. Construction of elementary weaves; plain, twill, satin weaves and their derivatives. Rib and cord structures. Construction of standard woven fabrics; poplin, sheeting, denim, drill and jean, gabardine, granite, diamond and diaper weaves, Honey comb, Huckaback and Mockleno weaves. Colour effect on woven design. Dobby design, stripes and checks. Construction of jacquard design. Figuring with extra threads. Damasks and Brocades. Double cloths. Multilayer fabrics. Tapestry structures. Gauze and Leno structures. Whip cord and Bedford cord. Pique and Wadded structures. Terry pile structures. Velvet and velveteen. Axminster carpet structures. Indian traditional designs. Introduction to CAD for woven designs.

TXL361 Evaluation of Textile Materials

3 Credits (3-0-0)

Pre-requisite(s): TXL222 and TXL232

Introduction to textile testing; Sampling and basic statistics: Selection of samples for testing; Random and biased samples; Different types of sampling of textile materials; The estimation of population characteristics from samples and the use of confidence intervals; Determination of number of tests to be carried out to give chosen degree of accuracy; Test of significance of means and variance; Related numerical; Quality control charts and their interpretation; Standard tests, analysis of data and test reports, Correlation and coefficient of determination; Analysis of variance (ANOVA).

Testing methods: Measurement of length, fineness and crimp of fibres; Determination of maturity, foreign matter, and moisture content of cotton; Principles of AFIS, HVI etc.; Measurement of twist, linear density and hairiness of yarn; Evenness testing of silvers, rovings and yarns; Analysis of periodic variations in mass per unit length; Uster classimat; Spectrogram and V-L curve analysis; Tensile testing of fibres, yarns and fabrics; Automation in tensile testers; Tearing, bursting and abrasion resistance tests for fabrics; Pilling resistance of fabrics; Bending, shear and compressional properties of fabrics, fabric drape and handle (KESF, FAST etc); Crease and wrinkle behavior; Fastness characteristics of textiles; Matching of shade; Air, water and water-vapour transmission through fabrics; Thermal resistance of fabrics; Testing of interlaced and textured yarns; Special tests for carpets and nonwoven fabrics. Testing of special yarns (textured yarns, core yarn, ropes, braids etc). Testing of special fabrics (different types of nonwovens, carpets, different types of technical textiles like bullet proof fabrics, UV protective fabrics, EMS fabrics etc.).

TXP361 Evaluation of Textiles Lab

1 Credit (0-0-2)

Pre-requisite(s): TXL222 and TXL232

Introduction to textile testing; Experiments related to the lecture course entitled "Evaluation of Textile Material".

TXL371 Theory of Textile Structures

4 Credits (3-1-0)

Pre-requisite(s): TXL222 and TXL232

Basic characteristics of yarn structure. Koechlin's theory relating yarn count, twist, packing density, and diameter. Helical model of fibres in yarns. Radial migration of fibres in yarns. Tensile behavior of yarns. Theory of yarn mass variation in spun yarn. Theory of plied yarn. Basic characteristics of fabric structure. Flexible and rigid thread models of woven fabric geometry. Tensile, bending, and shear deformation of woven fabric. Geometry of knitted structures and basic nonwoven structures.

TXL372 Speciality Yarns and Fabrics

2 Credits (2-0-0)

Pre-requisite(s): TXL222 and TXL232

Design, manufacture, characterization and applications of specialty yarns. Hybrid yarns. High bulk yarns. Electro-conductive yarns. Technical sewing threads. Coated yarns. Reflective yarns. Elastomeric yarns. Yarn quality requirement. Yarn preparation & production technology. Structural design, properties-Performance and applications of specialty fabrics. Denim. Pile fabrics. Narrow fabrics. 3D fabrics. Spacer fabrics. Profiled fabrics. Contour fabrics. Polar fabrics. Spiral fabrics. Multi-functional fabrics, Leno fabric.

TXL381 Costing and its Application in Textiles

4 Credits (3-1-0)

Pre-requisite(s): TXL211/TXL221/TXL231 and EC 75

Importance of costing. Material costing in textile industry. Methods of inventory costing. Economic order quantity, price discount, safety stock, lead time. Allocation of labour cost-shift premium, overtime, idle time, rush orders in garment industry. Allocation of overheads in composite mills. Job order costing in garment industry. Economic batch quantity. Process costing in mill. Unit cost of yarns, fabric and processing. Joint and by-product costing. Absorption costing. Variable costing for decision making. Profit planning in textile industry, variation of price, costs etc., breakeven capacity. Standard costs of fibres, yarns, labour etc. HOK, OHS, UKG etc. Cost variance analysis-iteration of actual costs of fibre, labour and overhead with respect to standard costs. Work allocation to spinner. Balancing of machine for optimizing product mix in a spinning mill. Financial information-balance sheet, profit/loss account, balance sheet. Ratio analysis.

TXD401 Major Project Part I

4 Credits (0-0-8)

Pre-requisite(s): TXL361/TXP361/TXL371/TXL372 and EC 100

Formation of project team (up to two students and up to two faculty guides); formulation of work plan completing targeted work for the semester and presentation of complete work of progress for award of grade.

TXD402 Major Project Part II

8 Credits (0-0-16)

Pre-requisite(s): EC100 and Minimum B Grade in TXD401

Continuation of planned tasks started in Major Project Part I, TXD411, to completion, thesis writing and presentation of complete work of progress for award of grade.

TXL601 Basics of Textiles

0 Credits (2-0-0)

This is an audit bridge course designed for M.Tech and Ph.D students with non-Textile background. The program is not available for B.Tech

students. The course is divided into four modules giving an overview on a) Fibre Science: Polymers, Textile Fibres and their classification, Homopolymer, copolymers and graft polymers; their molecular weight, distribution, architecture, configuration and confirmations, amorphous and crystalline phases, glass transition, crystallization and melting, Step growth and chain polymerization; Basic Introduction to Fibre structure, general properties such as moisture absorption, tenacity, elongation, initial modulus, yield point, toughness and elastic properties, Spinning, Melt spinning, Solution Spinning and Electrospinning; Introduction to manmade and synthetic fibres: viscose, acetate, acrylic, nylon, polyester, introduction to high performance fibers and their applications.

b) Yarn: Classification of yarn, filament and staple, yarn specifications, yarn counting system, yarn diameter, twist and yarn physical and mechanical characteristics; Flow chart of cotton spinning process, Importance of fibre characteristics, Impurities in natural fibres, Cleaning principles, Mixing and blending of fibres; sliver formation by card; Cardic mechanic configuration; Fibre configuration in card sliver; Drafting process, roller and apron drafting; Objectives of combing, Principle of fibre fractionation; Principle of roving preparation and yarn formation, Drafting and different methods of twisting.

c) Fabric: Yarn to fabric conversion, Basic principles, Introduction to various fabric formation principles, weaving, knitting, nonwoven and braiding; Weaving principles-stages of woven fabric manufacturing winding, warping, sizing, Drawing in primary and secondary motions, Shuttle and shuttle less looms, Basic fabric design as plain, matt, rib, twill and satin; Knitting: basics warp and weft constructions, different knitting structures and their properties, weft and warp knitting machines; Nonwovens: definitions, classifications, production technology and applications; Braided structures and their technologies and applications.

d) Textile Chemical Processing: Natural and added impurities in Textiles, singeing, desizing, scouring, bleaching, mercerization of cotton; Carbonisation, scouring and bleaching of wool, Degumming of silk and Assessment processes; principles of dyeing and printing of textile materials, basic characteristics of dyes, chemical structures of dyes, classification, dyeing of cotton, polyester, wool/nylon; Methods of printing, preparation of printing pastes, Direct discharge and resist printing styles; Introduction to chemical and mechanical finishes; chemical finishes for hand modifications; Easy oil, water and soil repellency; Fire retardant and antimicrobial finishes

TXL700 Modelling and Simulation in Fibrous Assemblies

3 Credits (2-0-2)

Pre-requisite(s): TXL232 and EC 75

Introduction to Textile Modelling and Simulation, types of model. Curve Fitting Techniques: Prediction of mechanical properties of fibrous assemblies.

Artificial Neural Network (ANN): Mathematical models of artificial neurons, ANN architecture, Learning rules, Back propagation algorithm, Applications of ANN. Fuzzy Logic: Crisp and fuzzy sets, Operations of fuzzy sets, Fuzzy rule generation, Defuzzification, Applications of fuzzy logic. Genetic Algorithm (G.A.): Basics of G.A., G. A. in fabric engineering.

Stochastic and Stereological Methods: Random fibrous assemblies, anisotropy characteristics, two and three-dimensional fibrous assemblies. Statistical Mechanics: Monte Carlo simulation of random fibrous assemblies.

Multiscale Modelling: Geometrical modelling of textile structures, modelling of properties of fibrous assemblies

Computational Fluid Dynamics: Newtonian and Non-Newtonian Fluids and their applications in extrusion processes, Computer simulation of fluid flows through porous materials, heat and mass transfer in fibrous assemblies.

TXV701 Process Cont. and Econ. in Manmade Fibre Prod.

1 Credit (1-0-0)

Pre-requisite(s): TXL211/TXL221/TXL222/TXL231/TXL232 and EC 75

Introduction to manmade fibres. Consumption pattern in India

and World. Factors affecting their growth. Economics of manmade fibre production. Modern polyester manufacturing plant technology. Capacities, raw materials and economics. Process and parameters at polymerization. Melt spinning and draw line. Control of modulus, tenacity, crimp properties, Dye affinity during production. Typical properties of polyester staple fibre. Partially oriented yarn and fully drawn yarn. Commodity and specialty polyester fibres. Recycled polyester staple fibres. Bio-degradable polyester PLA. Applications, properties and selection of fibres as per end uses.

TXV702 Management of Textile Business

1 Credit (1-0-0)

Pre-requisite(s): TXL222/TXL232 and EC 75

The textile industry of India : Past & its evolution to the present day. The structure of the Indian textile industry. Cotton textile sector, Jute textile sector. Silk textile sector. Manmade textile sector. Wool textile sector. Statistics of Indian textile business (domestic & export) and world textile trade. Textile policy 2000. Govt. of India. World trade practices. Norms, barriers etc. Various pertinent issues prevailing impacting textile industry and trade. Corporate social responsibility. Other compliances. ISO accreditation, etc. Retailing in textiles vis-a-vis consumer trend and behaviour. The challenging future of the Indian textile industry and trade.

TXV703 Special Module in Textile Technology

1 Credit (1-0-0)

Pre-requisite(s): TTXL222/TXL232 and EC 75

The course aims at introducing special topics in textile technology. The course topics and content are likely to change with each offering depending upon the current requirement and expertise available with the department including that of the visiting professionals.

TXV704 Special Module in Yarn Manufacture

1 Credit (1-0-0)

Pre-requisite(s): TXL222 and EC 75

The course aims at introducing new or highly specialized technological aspects in yarn manufacture. The course topics and content are likely to change with each offering depending upon the current requirement and expertise available with the department including that of the visiting professionals.

TXV705 Special Module in Fabric Manufacture

1 Credit (1-0-0)

Pre-requisite(s): TXL232 and EC 75

The course aims at introducing new or highly specialized technological aspects in fabric manufacture. The course topics and content are likely to change with each offering depending upon the current requirement and expertise available with the department including that of the visiting professionals.

TXV706 Special Module in Fibre Science

1 Credit (1-0-0)

Pre-requisite(s): TXL211/TXL221/TXL222/TXL231/TXL232 and EC 75

The course aims at introducing new or highly specialized technological aspects in fibre science. The course topics and content are likely to change with each offering depending upon the current requirement and expertise available with the department including that of the visiting professionals.

TXV707 Special Module in Textile Chemical Processing

1 Credit (1-0-0)

Pre-requisite(s): TXL211/TXL221/TXL222/TXL231/TXL232 and EC 75

The course aims at introducing new or highly specialized technological aspects in textile chemical processing. The course topics and content are likely to change with each offering depending upon the current requirement and expertise available with the department including that of the visiting professionals.

TXL710 High Performance and Specialty Fibres

3 Credits (3-0-0)

Pre-requisite(s): TXL212 and EC75

Definition, classification and structural requirements of high performance and specialty fibres, Polymerization, spinning and properties of aramids, aromatic polyesters, rigid rod and ladder polymers such as PBZT, PBO, PBI, PIPD, Manufacture of carbon fibres from polyacrylonitrile, viscose and pitch precursors, Concept of gel spinning and spinning of UHMPE fibres, Elastomeric polymers and fibres, Lyocell fibre production, Conducting fibres, Thermally and chemically resistant polymers and fibres, Methods of synthesis, production and properties of: glass and ceramic fibres. Specialty fibres: profile fibres, optical fibres, bicomponent fibres and hybrid fibres, Superabsorbent polymers and fibres.

TXL711 Polymer and Fibre Chemistry

3 Credits (3-0-0)

The course will deal with chain and step growth polymerization methods, polymer's macromolecular architecture, molecular weight of polymers, copolymerization, cross-linked polymers, general structure and characteristics of polymers, spectroscopic analysis of polymers, properties of fiber forming polymers and their applications.

TXP711 Polymer and Fibre Chemistry Laboratory

1 Credit (0-0-2)

Identification of fibres by chemical and burning tests, polymerization of vinyl monomers such as styrene, acrylamide using bulk polymerization, solution polymerization, emulsion polymerization, radiation induced polymerization. Condensation polymerization and interfacial polymerization of nylon-6, Molecular weight measurement. Intrinsic viscosity and end group analysis, preparation of phenol-formaldehyde resin. Analysis of chemical structure by FTIR, UV spectroscopy.

TXL712 Polymer and Fibre Physics

3 Credits (3-0-0)

Molecular architecture, configuration, conformation of ideal and real chains, Random Walk models of polymer conformations, Gaussian chain, Self-avoiding walks and excluded-volume interaction, the amorphous phase and its chemical-physical aspects, the glass transition phenomenon, the WLF-equation, crystalline state and its chemical-physical aspect, cross-linked polymers and rubber elasticity, behaviour of polymers in solutions and mixtures, viscoelasticity and rheology of polymers, mechanical properties, physical properties of fibres: moisture absorption properties, mechanical properties, optical properties, thermal properties.

TXP712 Polymer and Fibre Physics Laboratory

1 Credit (0-0-2)

Laboratory Experiments on Characterization of fibres by Infrared spectroscopy, Density measurements; Thermal analysis: Thermogravimetric Analysis (TGA), Differential Scanning calorimetry (DSC) and Thermo-Mechanical Analysis (TMA); Dynamic Mechanical Analysis (DMA); Sonic modulus ;X-ray diffraction studies; Birefringence measurement; Optical microscopy studies; Scanning Electron Microscopy (SEM) of fibres: Creep and Stress Relaxation study, Mechanical property testing such as tensile and flexural rigidity.

TXL713 Technology of Melt Spun Fibres

4 Credits (3-1-0)

Importance of transport phenomena in fibre manufacturing; Fundamentals of momentum transfer, heat transfer, mass transfer, building differential equations using shell balance and generalized equations; Polymer rheology- shear flow, elongational flow; Melt spinning lines for filament and staple fibre; Role of spin finish; Necessary conditions for fibre formation, elasticity versus plasticity of melts; Melt instabilities; Thermodynamic limitations; Force balance and heat balance in melt spinning; Low speed melt spinning; Necking and stress induced crystallization in high speed melt spinning; Effect of process parameters on fibre spinning and structure of nylon 6, PET and PP; Drawing Process and its necessity; Neck or flow

deformational drawing; Drawing machines; Effect of parameters on structure development in nylon 6, PET, PP; Types of heat setting, Effect of setting parameters on structure and properties; Concept of bulking/texturing.

TXL714 Advanced Materials Characterization Techniques 1 Credit (1-0-0)

Relevance of advanced characterization techniques in material development; scattering techniques (SAXS/WAXS); advanced surface characterization techniques (X-ray photoelectron spectroscopy (XPS), Auger electron spectroscopy (AES), secondary ion mass spectroscopy (SIMS)); microscopy techniques: basics of electron-materials interaction; SEM combined with FIB techniques; TEM and cryo-TEM; chemical analysis utilizing microscopy techniques; AFM; confocal laser microscopy.

TXL715 Technology of Solution Spun Fibres 3 Credits (3-0-0)

Pre-requisite(s): TXL711/TXL713

PAN properties; Solution rheology and its dependence on parameters. Effect of parameter on entanglement density, fibre spinning and subsequent drawing; Various solvent systems; Dope preparation; Wet and dry spinning processes; Effect of process parameters such as dope concentration, bath concentration, temperature and jet stretch ratio on coagulation rate, fibre breakage and fibre structure; Modeling of coagulation process; properties and structure of dry and wet spun fibres; Dry jet wet spinning. Solution spinning of PAN.

Bicomponent and bulk acrylic fibres. Acrylic fibre line, crimping and annealing, tow to top conversion systems; Viscose rayon process, Spinning with and without zinc sulfate; Polynosics and high performance cellulosic fibre; Non viscose processes, Lyocell spinning process, structure and properties; Gel spinning of PE, Gel spinning of PAN and PVA. Introduction to high performance fibres and their spinning systems such as rigid rod polymer, liquid crystalline polymers, polylactic acid and spandex fibre manufacturing.

TXP716 Fibre Production and Post Spinning Operation Laboratory

2 Credits (0-0-4)

Experiments related to fibres production processes. Effect of moisture and temperature on MFI of PET and PP. Melt spinning of PET, PP & nylon-6 filament yarns on laboratory spinning machines. Single and two stage drawing of the as-spun yarns or industrial POY. Demonstration of high speed spinning machine. Wet and dry heat setting of PET and nylon drawn yarns. Effect of temperature and tension on heat setting. Determination of structure and mechanical properties of as spun, POY, drawn and heat set yarns using DSC, X-ray, FTIR, density, sonic modulus. Effect of shear rate, temperature on polymer solution viscosity using Brookfield Rheometer and ball-fall method. Wet spinning or dry jet wet spinning of PAN copolymers. False twist and air jet texturing processes. Determination of structure of textured yarn under microscope.

TXL719 Functional and Smart Textiles 3 Credits (3-0-0)

Pre-requisite(s): TXL212/TXL221/ TXL231 and EC75

Definition and Classification of Functional and Smart textiles ; Introduction to Composites : Theory, Types, Properties ; High Performance fibers, thermoplastic and thermosetting Resins; Composite Manufacturing and Applications; Coated and laminated Textiles: materials, formulations, techniques and applications ; Protective Textiles- Materials, design, principles and evaluation for protection against fire, harmful radiation, chemicals and pesticides; Sportswear: design, testing and materials – fibers , yarns, fabrics for temperature control and moisture management; Medical textiles: Classification, types and products, Health and Hygiene Textiles-protection against microbes, Wound management- dressings, suture and bandages, Implants and drug delivery systems ; Smart and Intelligent Textiles : Passive and Active functionality, stimuli sensitive textiles, Electronic Textiles : wearable computers, flexible electronics.

TXL721 Theory of Yarn Structure 3 Credits (3-0-0)

General description of yarn structure, Packing of fibre arrangement in yarns, Fibre directional arrangement in yarns, Geometry of pores in yarns, Relationship among yarn count, twist, and diameter, Helical model of fibers in yarns, Yarn retraction, Limits of twisting, Radial migration of fibers in yarns, Model of ideal fibre migration, Model of equidistant migration, Tensile mechanics of yarns, Yarn tensile behavior in light of helical model, Relationship between tensile behaviors of fiber and yarn, Yarn strength as a function of gauge length, Bending mechanics of yarns, Mass unevenness of yarns, Martindale's model of mass irregularity, Model of hierarchical structure of fibre aggregates, Hairiness of staple fiber yarns, Single- and double-exponential models of yarn hairiness, Structure and mechanics of plied yarns.

TXL722 Mechanics of Spinning Processes 3 Credits (3-0-0)

Principles of bale management. Forces acting on fibres during opening and cleaning, analysis of fibre compactness and blending in blowroom. Carding process, cylinder load and transfer efficiency, design of high production card, fibre shedding and card wire geometry, fibre configuration in card and drawn sliver. Fibre movement in drafting field, drafting wave, drafting force, roller slip, roller eccentricity and vibration, autolevelling. Fibre fractionation in comber, combing performance. Analysis of forces on yarn and traveller, spinning tension in ring and rotor spinning, spinning geometry, twist flow in ring and rotor spinning, end breaks. Mechanism of drafting and yarn formation in high speed spinning systems.

TXL724 Textured Yarn Technology 3 Credits (3-0-0)

Pre-requisite(s): TXL221/TXL222 and EC75

Principles of texturing and modern classification; False twist texturing process- mechanisms and machinery, optimization of texturing parameters, barre', structure-property correlation of textured yarns; Draw-texturing- the need and fundamental approaches; Friction texturing- the need and development, mechanics of friction texturing, latest development in twisting devices, optimization of quality parameters. Noise control in texturing.

Air jet texturing- Principle, mechanisms, development of jets and machinery, process optimization and characterization, air jet texturing of spun yarns. Air interlacement-Principle and mechanism, jet development and characterization. Bulked continuous filament yarns- Need, principle, technology development. Hi-bulk yarns- Acrylic Hi-bulk yarn production, mechanism and machines involved, other such products. Solvent and chemical texturing- Need, texturing of synthetic and natural fibres.

TXL725 Mechanics of Spinning Machines 3 Credits (3-0-0)

Drive systems, belt drives, belt tensions, power transmission, variable, PIV and reversing drives. Polygonal effect in chain drives. Gear types, design aspects, interference and periodic faults, thrust loads and elimination, gear selection, planetary gear trains in spinning machines. Design of cone pulleys, design of transmission shafts and drafting rollers-materials, design against torsional & lateral rigidity. Clutches and brakes-design, torque transmission capacity and application in textile machines. Bearings- bush bearings, theory of lubrication, rolling contact bearings in spinning machines. Machine balancing-static, couple and dynamic unbalance, balancing of card cylinder, plane transposition, practical aspects of balancing, Cams in roving and ring spinning machines.

TXP725 Mechanics of Spinning Textile Machines Laboratory 1 Credit (0-0-2)

Students will do design analysis of various machine elements on textile machines.

TXL731 Theory of Fabric Structure

3 Credits (3-0-0)

Engineering approach to fabric formation. Fibre, yarn and fabric structure- property relationships. Crimp interchange in woven fabric. Elastica model for fabric parameters and crimp balance. Concept of fabric relaxation and set. Practical application of geometrical and elastica models, Uniaxial and biaxial tensile deformation of woven fabric. Bending deformation of woven fabric, bending behaviour of set and unset fabrics and bending in bias direction. Bending, Shear and drape properties of woven fabric. Buckling and compressional behaviour of woven fabrics. Mathematical models and their application in the study of tensile, bending, shear, compressional and buckling deformation of woven fabrics. Structure and properties of knitted fabrics, Structure-property relationship of nonwoven fabrics, Mechanical behavior of braided structures, Theory of fabric low stress mechanical properties and fabric hand, Fabric formality.

TXL732 Advanced Fabric Manufacturing Systems

3 Credits (3-0-0)

Fabric manufacturing systems, Yarn quality and weavability, Yarn Preparation for High speed weaving, Preparation of high performance fibres/tows for weaving, Sizing of filament yarn, Shuttle less weaving systems: Advancements in each system with respect to productivity, yarn characteristics and fabric quality, energy requirement, design flexibility, applications and limitations, Specialty weaving: 3D weaving, Multilayer weaving, Spacer weaving, Profiled weaving, Polar and Spiral fabric, Circular Weaving, Honeycomb weaving, Denim manufacturing, Multiaxial weaving, Multiphase weaving, Terry weaving, Leno Weaving, Filament Weaving, Properties and applications of fabrics produced in these systems. Weft and warp knitted structures for technical applications, Braiding; biaxial and triaxial braids, 3D braiding, Structure, properties and applications of braided fabrics, Developments in nonwoven technologies, Stitch bonding methods, Nonwoven composite fabrics, Electrospinning, 3D nonwovens.

TXL734 Nonwoven Processes and Products

3 Credits (3-0-0)

Pre-requisite(s): TXL232 and EC 75

Definitions of nonwoven and their scopes and limitations. Staple fibre preparation processes. Staple fibre web formation processes: carding, air-laying, and wet-laying. Staple fibre web stacking processes: parallel-laying, cross-laying, and perpendicular-laying, Mechanical bonding processes: needle-punching and hydroentanglement. Thermal bonding processes: calendar, through-air, impingement, infra-red, and ultrasonic bonding. Chemical bonding process. Spunmelt processes: spunbonding and meltblowing, Medical nonwovens, Hygiene nonwovens, Nonwoven wipes, Nonwoven filters, Geononwovens, Automotive nonwovens, Case studies.

TXL740 Science & App. of Nanotechnology in Textiles

3 Credits (3-0-0)

Pre-requisite(s): EC75

Introduction to Nanoscience and Nanotechnology; Size and surface dependence of their physical and chemical properties such as mechanical, thermodynamical, electronic, catalysis etc; Synthesis of Nanomaterials used in Textiles such as carbon nanotube, fullerenes, metal and metal oxide nanoparticles i.e. nano silver, nano silica, nano titania, nano zinc oxide, nano magnesium oxide etc.; Surface functionalization and Dispersion of nanomaterials; Nanotoxicity, Characterization techniques i.e. XRD, AFM, SEM/TEM, DLS etc.; Nanomaterial applications in textiles and polymers; Nanocomposites: definition types, synthesis routes; nanocomposite fibres and coatings e.g. gas barrier, antimicrobial, conducting etc.; Nanofibres: preparation, properties and applications i.e. filtration, tissue engineering etc.; Nanofinishing: self-cleaning, antimicrobial, UV protective etc.; Nanocoating on textile substrates: Plasma Polymerisation, Layer-by-layer Self Assembly, Sol-Gel coating etc.

TXL741 Env. Manag. in Textile and Allied Industries

3 Credits (3-0-0)

Pre-requisite(s): TXL212/TXL241/TXL242 and EC 75

Importance of ecological balance and environmental protection. Definition of waste and pollutant. Pollutant Categories and types. International and Indian legislation and enforcing agencies in pollution control. Waste management approaches; Environmental Management Systems' ISO 14000. Environmental impact along the textile chain from fibre production to disposal. Toxicity of intermediates, dyes and other auxiliaries etc. Pollution load from different wet processing operations. Textile effluents and their characterization. Technology and principles of effluent treatment. Advanced colour removal technologies, Recovery and reuse of water and chemicals. Air and noise pollution and its control. Eco labeling schemes. Industrial hygiene and safe working practices. Analytical testing of eco and environmental parameters. Eco friendly textile processing: waste minimization. Standardization and optimization, process modification. Safe & ecofriendly dyes and auxiliaries. Organic cotton, natural dyes, naturally coloured cotton, Solid (fibre & polymer waste) recycling recovery of monomers, energy recovery and chemical modification of fibre waste.

TXL 747 Colour Science

3 Credits (3-0-0)

Pre-requisite(s): EC 75

Colour and chemical constitution, physics and chemistry of light, vision, colour. Physics of light sources, measurement of colour Colorimeters and Spectrophotometers, Standard observer experiments, CIE system, Tristimulus values, and different colour order systems. Principle of recipe prediction and demonstration, visual and instrumental evaluation of whiteness, shade sorting, colour uncertainty, colour constancy and metamerism, colour difference formulae, How we see colour, colour in visual displays and use of colour in design.

TXL748 Advances in Finishing of Textiles

3 Credits (3-0-0)

Overview of textile processing industry- current and future trends. Merging of technologies for creative solutions. Advances in preparatory processes- bioscouring, combined processes, bleaching and mercerisation. Reducing water and energy consumption - Efficient liquor extraction, Low wet pick up and drying technologies. Classification of finishes. Advance in mechanical finishes - calendaring, raising, emerging, softening. Principles and chemistry of Chemical finishes - easy care, antimicrobial, anti UV, antistat, softening, Flame retardant, water repellent. Principle of repellency, oil, water and soil, self-cleaning textiles. Wellness finishes for aroma, health and hygiene. New technologies - microencapsulation, plasma, nanotechnology. Finishing of technical textiles. Membranes and laminates.

TXP 748 Textile Preparation and Finishing Lab

1 Credit (0-0-2)

Pre-requisite(s): TXL747/TXL753

Preparatory and finishing related project based experiments, Chemistry and principle of each treatment and analysis of results.

TXL 749 Theory and Practice of Dyeing

3 Credits (3-0-0)

Pre-requisite(s): EC 75

Advances in dyes, Speciality dyes: photochromic, thermochromic, electrochromic, mechanochromic; Fluorescent and near IR dyes; Dyes for camouflage; Banned dyes; Safe and eco-friendly dyes, natural dyes; Mechanisms of dyeing; Thermodynamics of dyeing; Kinetics of dyeing; Dye-fibre interactions; Role of fibre structure in dyeing; Advances in dyeing processes: low liquor, salt free, low energy intensive dyeing; Dyeing of blends; Mass coloration of man-made fibres; Dyeing of speciality fabrics: stretch fabrics, light weight, textured, garment dyeing, micro-denier fabrics, fibre dyeing; Effect of finishes on shade and fastness; Dyeing faults and case studies.

TXP 749 Textile Coloration Lab

1 Credit (0-0-2)

Pre-requisite(s): B Tech. Textile/ BE Textile/ MSc Textile

Project based experiments in dyeing and colouration, dyeing of fabric, visual and instrumental assessment of shade variation. Subjective vs objective evaluation, Shade sorting, whiteness index. Azo dye synthesis and characterization.

TXL750 Science of Clothing Comfort

3 Credits (3-0-0)

Pre-requisite(s): TXL361 and EC75

Clothing Comfort: Brief introduction to the various processes related to comfort, Application of science of clothing comfort. Psychology and comfort: basic concepts, Psychological research techniques, General aspects and measurement of aesthetic properties, changes in aesthetic behaviour. Neurophysiological Processes of Comfort: Neurophysiologic basis of sensory perceptions, Perceptions of sensations related to mechanical, thermal and moisture stimuli. Thermal transmission: Thermoregulatory mechanisms of human body, heat transfer theories, thermal conductivity of fibrous materials, steady state measurement techniques for heat transfer, transient heat transfer mechanism: warm-cool feeling. Moisture Transmission: transfer of liquid moisture and vapour transfer through fibrous materials. Dynamic Transmission of heat and moisture: Relationship of moisture and heat, multiphase flow through porous media, moisture exchange between fibre and air, temperature and moisture sensations: theories and objective measurement techniques, impact of microclimate. Tactile Aspects of Comfort: Fabric mechanical properties and tactile- pressure sensations like fabric prickliness, itchiness, stiffness, softness, smoothness, roughness and scratchiness, fabric hand value, clothing comfort aspects in relations with garment size and fit.

TXL751 Apparel Engineering and Quality Control

3 Credits (2-0-2)

Pre-requisite(s): TXL211/TXL221/TXL222/TXL231/TXL232 and EC75

Introduction to clothing manufacture, Apparel Engineering Concept in Garment Industry, Need of Apparel engineering, Role and Methodology of Apparel Engineering, Industrial engineering concept in apparel engineering, Standardization and Production scheduling, Sewing Dynamics, Mechanics of sewing operation, Measurement and controls in sewing operation, Automation in sewing process, Modeling of sewing machine and operation, Fabric quality assessment for clothing industry, Evaluation and Application of low stress mechanical properties for making up process, Fabric mechanical properties and sewing operation interaction, Concept of Tailorability, Formability and Lindberg theory, Quality control in apparel manufacturing, Determination of sewability, Effect of sewing on fabric mechanical and aesthetic properties, Fabric defects and their impact on garment quality, Quality inspection and defects in apparels, Evaluation of sewing threads, Evaluation of clothing accessories, Material Functionality in clothing, Engineering of functional clothing.

TXP 751: Characterization of Chemicals and Finished Textiles Lab

1 Credit (0-0-2)

Pre-requisite(s): B Tech. Textile/ BE Textile/ MSc Textile

Evaluation, characterization and analysis of textile auxiliaries, chemicals, dyes, and water, Project based experiments for evaluation of the dyed and finished textiles.

TXS751: Research Seminar

1 Credit (0-0-2)

Pre-requisite(s): TXT800

Presentation and discussion based on work done during internship or selected topics on current and future technologies.

TXL752 Design of Functional Clothing

3 Credits (3-0-0)

Pre-requisite(s): EC75

Functional clothing - definition and classification. Techniques in design of functional clothing - 3D body scanning, human motion analysis, 2D/3D CAD and 3D modelling. Design of patterns, garment assembling methods. Ergonomics in design of functional clothing. Principles and practice of Anthropometrics. Biomechanical considerations in design of clothing. Performance evaluation of performance clothing - subjective and objective methods, modeling and simulation. Human mechanics

and operational performance. Modelling, optimization and decision making techniques in design of functional clothing. Certification and standardization. Case studies - swimwear, sportswear, pressure garments, space suit, military clothing with a view to study specific design and manufacturing considerations.

TXR752 Professional Practices

1 Credit (0-0-2)

Pre-requisite(s): EC 75

Interaction and discussion with experts from industry and academia in the field of textiles and allied industries for sharing best practices followed in the industry including case studies, Exposure to a variety of topics and issues related to professional ethics.

TXL753 Advanced Textile Printing Technology

2 Credits (2-0-0)

Pre-requisite(s): EC 75

Historical development in textile printing techniques and machines; limitations thereof; theoretical concepts of transfer printing and scope; transfer printing inks, transfer paper, machines and process conditions; concept of digital printing, technology and challenges thereof, machines and principles, continuous jet versus drop-on-demand, suitability of inks for different class of fibre/ fabrics, auxiliaries needed, issues related to standardization, pre- and post-printing operations, scale and economics of operation. Printing faults and related process control principles, novel printing methods, raised, plasma, fancy, 3-D effects.

TXL 754 Sustainable Chemical Processing of Textiles

2 Credits (2-0-0)

Pre-requisite(s): EC 75

Concept of Sustainability, Green processing technologies – low liquor technologies, ozone, super critical carbon dioxide and ultrasound technologies. Technologies using organic and natural fibers, process technologies using new enzymes and foam technology, lowsalt reactive dyes, combined dyeing and finishing, Industrial hazardous waste management, in-plant management, reduction, recycling and disposal of waste. Hazards involved in chemical processing and laws related to environmental protection. Life cycle analysis with case studies, compliance, certification, social accountability and ethical practices. Concept of eco-labels, ISO 14024:2018.

TXL 755 Textile Wet Processing Machines: Automation and Control

3 Credits (3-0-0)

Pre-requisite(s): EC 75

Basic concepts of fluid flow, heat and mass transfer with specific emphasis on textile processes, Feedback control principles and systems, Sensors and transducers used in chemical processing machines; Machinery for processing of textiles in fibre, yarn and fabric form, batch and continuous machines. Machines for pre-treatment, dyeing, printing and finishing, developments in machinery for improving the effectiveness of treatment and reduction in chemical, energy and water consumption, mechanical finishing machines, garment processing.

TXL756 Textile Auxiliaries

3 Credits (3-0-0)

Pre-requisite(s): EC 75

Auxiliaries in textile chemical processing; Surfactants, emulsifiers, wetting agents, dispersing agents, foaming agents. Buffers, Electrolytes, Sequestering agents, enzymes, Sizing agents, thickeners, Binders, Fluorescent brightening agents, Oxidising and reducing agents, discharging agents, stain removing agents. Environmental assessment.

TXP761 Evaluation of Textile Materials

2 Credits (0-0-4)

Evaluation of clothing comfort, flammability, bursting strength, bandage pressure, UPF, impact resistance, pore size and filtration efficiency.

TXL771 Electronics and Controls for Textile Industry

4 Credits (3-0-2)

Overview of electronics and controls in modern textiles equipments and machines. Overview of basic analog electronics: Elements (R, L, C, V, I), circuit laws and theorems. Overview of basic digital electronics: Gates and ICs. Sensors and transducers (displacement, position, force, temperature, pressure, flow). Control elements, systems and examples. Data acquisition, analysis, control and automation by microprocessors and micro controllers. Motor and power drives. Power control devices. Some applications of data acquisitions and control systems in textiles and case studies.

TXL772 Computational Methods for Textiles

3 Credits (2-0-2)

Numerical analysis, First-degree approximation methods, Linear algebraic equations, ordinary differential equations, interpolation, Fundamentals of Computer Programming, Programming Methodology: Structured Programming and concepts of Object-Oriented Programming. Programming in C++ - Statements and Expressions, Control statements. Structure, Functions: Function Overloading etc. C++ as Object-Oriented Programming Language- Classes and Objects, Data Abstraction, Inheritance - Multilevel and Multiple inheritance etc., Polymorphism - operator overloading and virtual functions, file handling. Application development using C++.

TXL773 Medical Textiles

3 Credits (3-0-0)

Pre-requisite(s): TXL211/TXL221/TXL222/TXL231/TXL232 and EC75

Natural and synthetic polymers and Textile-based techniques used for medical application, Fibrous extracellular matrix of human body and their characteristic features, Cell-Polymer interaction, Non-implantable materials (Wound-dressing, related hydrogel and composite products, Bandages, Gauges), Implantable biomedical devices (Vascular grafts, Sutures, Heart valves), Extra-corporeal materials (Scaffolds for Tissue engineering, Rapid prototyping, Cartilage, Liver, Blood Vessel, Kidney, Urinary bladder, Tendons, Ligaments, Cornea), Healthcare and hygiene products (Surgical Gowns, masks, wipes, Antibacterial Textiles, Super absorbent polymers, Dialysis, Soluble factor release), Safety, Legal and ethical issues involved in the medical textile materials.

TXL774 Process Control in Yarn & Fabric Manufacturing

3 Credits (3-0-0)

Pre-requisite(s): TXL222/TXL232 and EC 75

Basics of automatic control, Statistical considerations in process control. Online and offline control measures in spinning. Control of yarn quality attributes. Spinning process performance. Post spinning problems. Control of winding, warping, sizing, weaving and knitting processes. Control of fabric defects and value loss. Yarn quality requirement and assessment for weaving.

TXL775 Technical Textiles

3 Credits (3-0-0)

Pre-requisite(s): TXL222/TXL232 and EC 75

Definition, classification, products, market overview and growth projections of technical textiles. Fibres, yarns and fabric structures in technical textiles and their relevant properties. Type and important characteristics of sewing threads. cords, ropes, braids and narrow fabrics. Textile and other filter media for dry and wet filtration. Fibre and fabric selection for filtration. Types and application of geosynthetics. Fibres and fabric selection criteria for geotextile applications. Application of textiles in automobiles. Requirement and design for pneumatic tyres, airbags and belts. Clothing requirements for thermal protection, ballistic protection. Materials used in bullet proof and cut resistant clothing. Material, method of production and areas of application of agrotiles. Different types of fabrics used for packaging. Methods of production and properties of textiles used in these applications.

TXL776 Design and Manufacturing of Textile Structural Composites

3 Credits (3-0-0)

Pre-requisite(s): TXL222/TXL232 and EC 75

Definition of composites, textile composites and textile structural composites, Textile materials for composites, Matrix and Reinforcements, Classification of Textile Reinforced Structures based on axis and dimension; non-axial, mono-axial, biaxial, triaxial and multiaxial structures, UD, 2D,3D structures, Structural anisotropy, parallel arrangement and series arrangement of components, Chopped strand and Milled fibres, Hybrid fabrics, Non-crimp fabrics, Laminates, Stitched structure, Embroidery structures, Composite Rope, Design, manufacture and applications of reinforcements, Manufacture and characterization of extra-light 3D hollow textile structures for composites, Methods of composite processing, Manufacturing techniques of complex structural Composites, Characterization of structural Composites, Theory of composites, Composite concepts and theory, Rule of mixture, the synergy effect, Logarithmic mixing rule, Geometry of reinforcement, Particular, granular, fibrillar, lamellar, Properties of components, properties of interface, mechanism of adhesion, Mechanics of composite, Failure theory, Damage analysis, Modeling and simulation of various reinforcement structures and their composites, Applications of Textile structural composites, Textile Reinforced Concretes, Fibre concrete bonding, textile structure reinforcement concrete architecture, Characterization and applications of reinforced concretes.

TXL777 Product Design and Development

3 Credits (3-0-0)

Pre-requisite(s): TXL222/TXL232 and EC 75

Introduction to product development, distinguishing features of textile products, and its classification. Generic product development process, identifying customer need and its analysis, development of specification, need to metric conversion. Concept generation methodology, concept selection. Material selection, performance characteristics of apparel, home textile and technical products, criterion for material selection. Role of fibre, yarn and fabric and finishing process on product performance. Industrial design, ergonomics and aesthetics, Product architecture, Anthropometric principles, fit. Principles of prototyping, 3 D computer modeling, free-form fabrication. Design options for improving properties and functional attributes of different products. Design logic for developing selected products, Analysis of products; Calculation of design parameters for a given end use, developing detail specification for each structural element.

TXL781 Project Appraisal and Finance

3 Credits (3-0-0)

Pre-requisite(s): TXL222/TXL232 and EC 75

Introduction to Project Finance - Description of Project Finance Transaction, difference between corporate finance and project finance, Indian Financial system, Structuring the Project, Limited Resource Structures, Capital Investments : Importance & Difficulties, CPV analysis, Financial statements, Financial statement analysis, Working capital management, Inventory management, Project cycle, Project Formulation, Project Appraisal, Financial appraisal, Economic Appraisal, Social Cost Benefit Analysis- Shadow Prices and Economic rate of return, Financing Projects, Sources of funding, Valuing Projects, NPV, IRR, MIRR, Real Options, Decision Trees and Monte Carlo Simulations, Financial Estimates & projections, Technical Analysis, Market & Demand Analysis, Investment Criteria, Cost of capital, Project Risk analysis, Sensitivity Analysis, Leverage analysis, Environment Appraisal of the project and Detailed Project Report, Case studies on Textile projects.

TXL782 Prod. & Operations Management in Textile Industry

3 Credits (3-0-0)

Pre-requisite(s): TXL222/TXL232 and EC 75

Indian textile industry scenario. Textile Policy. Production and operations management function. Operation strategy. Facility location and capacity planning. Production planning and control, aggregate planning, scheduling, PERT and CPM, product mix linear programming concepts. Inventory models, optimal order quantity,

economic manufacturing batch size, classification of materials, materials requirement planning, Just in time concept. Supply chain Management. Maintenance management. Plant modernisation. Motion and time study. Job evaluation and incentive scheme. Productivity, partial and total productivity, machine, labour and energy productivity, efficiency and effectiveness, benchmarking, measure to increase productivity. Forecasting, methods of forecasting. Total quality management and Six Sigma. Product pricing. Financial and profit analysis, investment decisions. Management information system.

TXL783 Design of Experiments and Statistical Techniques 3 Credits (3-0-0)

Pre-requisite(s): TXL211/TXL221/TXL231 and EC75

Objectives, principles, terminologies, guidelines, and applications of design of experiments. Completely randomized design. Randomized block design. Latin square design. Two level and three level full factorial designs. Fractional factorial designs. Robust design. Mixture experiments. Central composite and Box-Behnken designs. Response surface methodology. Multi-response optimization. Analysis of variance. Statistical test of hypothesis. Analysis of multiple linear regression. Use of statistical software packages.

TXL784 Supply Chain Management in Textile Industry 3 Credits (3-0-0)

Definition, objectives, stages and metrics of textile supply chain; Life cycle of textile products, demand and fashion forecasting, forecasting techniques, bull-whip effect, aggregate forecasting in apparel industry; Designing of textile supply chain network, make vs buy and location decisions of textile SCM, reverse logistics in textile SCM; Risk mitigation in global textile supply chain, coordination among fabric, apparel and accessories manufacturers, role of dominant power; Transportation and distribution strategies; Supplier selection in textile SCM, quantitative models; Lean, agile and leagile textile supply chains and their enablers, designing resilient textile supply chain; Push-pull supply chain, decoupling point in textile SCM; Green and low carbon textile supply chain; Case studies related to textile and apparel supply chains.

TXL786 Technology of Textile Coating and Lamination 3 Credits (2-0-2)

Pre-requisite(s): None for TTF, TTE, TTC and TTZ; TXL241, TXL242, TXP241, TXP242 for TT1

Materials for coating: Polymers, textile materials. Adhesives Compounding of polymers for coating, Methods of Coating, Films for lamination, Methods of lamination, Technical Products based on coating/lamination Coated and laminated textile products, Environmental aspects of coating/lamination Laboratory experiments includes coating of fabric with PVC, PU, acrylic, EVA, Silicones, PTFE polymers, rubber coating etc., Basic lamination with films.

TXL800: Industrial Summer Training

Non-Credit Mandatory for TCP

Pre-requisite(s): TXL747/TXL753/TXL749

Non-Credit course. The students will be required to undergo summer internship in a textile industry and present the experience of internship.

TXD801 Major Project Part-I (TXE)

6 Credits (0-0-12)

To learn about preparation of research plan and systematically carry out research project.

TXD802 Major Project Part-I (TXF)

6 Credits (0-0-12)

To learn about preparation of research plan and systematically carry out research project.

TXD803 Major Project Part-II (TXE)

12 Credits (0-0-24)

To learn about preparation of research plan and systematically carry out research project.

TXD804 Major Project Part-II (TXF)

12 Credits (0-0-24)

To learn about preparation of research plan and systematically carry out research project.

TXD805: Major Project Part I (TCP)

6 Credits (0-0-12)

Pre-requisite(s): TXL747/TXL748/TXL749/TXL753

Project work related to the area.

TXD806: Major Project Part II (TCP)

12 Credits (0-0-24)

Pre-requisite(s): TXL747/TXL748/TXL749/TXL753

Project work related to the area.

TXS805 Independent Study (Textile Engineering)

3 Credits (0-3-0)

Student should undertake a research oriented activity including software development, machine design & development, product & process development, instrumentation and in-depth study of a subject which is outside the regular courses offered in the program. This study should be carried out under the guidance of a faculty member. The subject area chosen by the student should be sufficiently different from the area of major project being pursued by the student.

The student should submit a detailed plan of work to the program coordinator before approval of registration for the course. The student registered for this course should give one mid-term presentation followed by a final presentation before a committee constituted by the program coordinator.

TXS806 Independent Study (TTF)

3 Credits (0-3-0)

Student should undertake a research oriented activity including software development, machine design and development, product & process development, instrumentation and in-depth study of a subject which is outside the regular courses offered in the program. This study should be carried out under the guidance of a faculty member. The subject area chosen by the student should be sufficiently different from the area of major project being pursued by the student.

The student should submit a detailed plan of work to the program coordinator before approval of registration for the course. The student registered for this course should give one mid-term presentation followed by a final presentation before a committee constituted by the program coordinator.

TXL807 Seminar (Textile Engineering)

2 Credits (0-2-0)

A comprehensive literature review on a research topic of current interest or futuristic, pertaining to a textile process or product or technology. Student should perform a comprehensive literature review on a research topic of current interest or futuristic, pertaining to a textile process or product or technology. The student should give an outline of the review and get approval from the program coordinator for registration of this course. The student registered for this course should give one mid-term presentation followed by a final presentation before a committee constituted by the program coordinator.

TXD809 Mini Project (Textile Engineering)

4 Credits (0-0-8)

This is an open ended course where the students are expected to design and develop a product or equipment or instrument relevant to the field of textile technology. In this process, the students are expected to demonstrate their ability to think on their own in design and development of hardware item. They are also expected to put down their thinking process in a report form with relevant literature background, methodology of design and development process and should have conducted some experiments with the developed hardware system. Finally, they need to present their work for the award of grade.

Centre for Applied Research in Electronics

CRL601 Basics of Statistical Signal Analysis

3 Credits (2-0-2)

Fundamentals of signals and systems, LTI systems, convolution, Fourier transforms, Z- transform, sampling and Nyquist criteria, set & probability theory, random variables, probability density / distribution functions, moments, characteristic and moment generating functions, transformation of a random variable, random process, stationarity, ergodicity.

Lab experiments using MATLAB will be given to understand the practical aspects of these concepts.

CRL611 Basics of RF and Microwaves

3 Credits (2-0-2)

Basic electromagnetics, plane waves and scattering, waveguide modes, Fourier series and transform, autocorrelation and power spectral density, holes and electrons in semiconductors, p-n junction.

CRL621 Fundamentals of Semiconductor Devices

3 Credits (3-0-0)

Si Crystal structure, crystal planes and directions, band formation in semiconductors, direct and indirect gap semiconductors, E-k diagram, concept of "hole" as charge particle, effective mass, carrier mobility, life time of carriers, recombination, doping of semiconductors, drift and diffusion currents in semiconductors, metal-semiconductor junctions, ohmic and non-ohmic contacts, Schottky diode, abrupt p-n junction, energy- band diagram, junction under zero-bias, forward bias and reverse bias; current calculations, break-down in p-n junction, diffused p-n junction; bipolar transistor: theory and operation; theory of MOS FET, ideal MOSFET, threshold voltage, sub-threshold conduction in MOSFET, C-V characteristics of MOS capacitor, short-channel effects.

CRL702 Architectures and Algorithms for DSP Systems

4 Credits (2-0-4)

Lectures:

Introduction – DSP Tasks and Applications, Real-time Signal Processing, Representation of DSP algorithms; Number Representations and Arithmetic Operations - Fixed point and floating point representations and arithmetic operations; Q notation; Digital Signal Processor Architectures – CPU, Peripherals; Specific DSP processor architecture; DSP Instruction Set and Assembly Language Programming – Instruction types; Parallel programming; Pipelining; Efficient programming; DSP Algorithms and their Efficient Implementation - a) Linear filtering; b) FFT and spectrum analysis; c) Scalar and vector quantization, source coding, linear prediction coding; d) Function generation; Software Design for Low Power Consumption.

The DSP architecture and assembly language programming will be studied in lectures and laboratory with reference to a specific DSP processor.

Laboratory:

1. Basic DSP algorithms using MATLAB, 2. Familiarization with DSP kit, 3. Real-time filtering, 4. PN Sequence generation, 5. FFT, 6. Lab project.

CRL704 Sensor Array Signal Processing

3 Credits (3-0-0)

Representation of space - time signals: Coordinate systems; propagating waves; wave number-frequency space; arrays and apertures; space-time random processes and their characterization; Signal modeling and optimal filters: AR, MA, ARMA models; Autocorrelation and power spectral density; linear MMSE estimator; optimum filters; Power spectrum estimation: Non-parametric and parametric methods; Arrays and spatial filters: Frequency-wavenumber response and beam patterns; ULA; Performance measures; Synthesis of linear arrays and apertures: Spectral weighting; array polynomials; pattern sampling in wavenumber space, minimum beamwidth for specified sidelobe levels, broadband arrays; Optimum beamforming: MVDR beamformers; MMSE beamformers; Eigenvector beamformers; Adaptive beamforming: Least mean squares algorithms; Recursive

least squares; Generalized sidelobe canceler; Array geometries in higher dimensions: Rectangular arrays; Circular arrays; Spherical arrays; Cylindrical arrays.

CRL706 Selected Topics in Radars and Sonars

3 Credits (3-0-0)

The Radar and Sonar Equations: Basic System Parameters; Radar and Sonar Applications; Signal Design for range and Doppler resolution: Ambiguity functions, waveforms for CTFM/FMCW, MTI Radar, Pulse Doppler Radar; Detection theory for target extraction from clutter/reverberation and noise (clutter/reverberation modeling); Synthetic Aperture Radar/Sonar; Target Tracking: active/passive, Monopulse Radar; Modern Techniques: thru-the-wall imaging, multi-static systems.

CRL707 Human & Machine Speech Communication

3 Credits (3-0-0)

Overview of human and machine speech communication: Applications; Speech signal measurement and representation. Speech science topics: Speech production and phonetics: Speech production mechanism; Articulatory and acoustic phonetics; Speech production model; International Phonetic Alphabet; Phonetic transcription; Hearing and perception. Speech signal analysis: Time domain analysis; Spectrum domain analysis; Spectrogram; Cepstrum domain analysis; Pitch estimation; Voicing analysis; Linear prediction analysis. Engineering applications: Speech coding; Speech quality assessment: Subjective and objective evaluation of quality; Automatic speech recognition: HMM; Language models; Keyword spotting; Text-to-speech synthesis: Concatenative and HMM speech synthesis; Prosody modification.

The course will include audio demonstrations and require students to do practical exercises with recorded speech signals. An isolated word speech recognizer using open source resources shall be designed.

CRL708 Sonar System Engineering

3 Credits (3-0-0)

Introduction to Sonar applications, Units, Sonar Equations and their limitations, Propagation of sound, Transmission loss, Ambient Noise, Spatial Correlation, Directivity Index, Array Gain, Beam-patterns, Projector Source level, Reverberation, Scattering by targets, echo formation, Radiated Noise and Self Noise, Transmission and Reception modes, Dynamic Range Compression and Normalisation, Receiver Beamforming techniques, Sidelobe nulling, Detection Performance issues, Performance prediction, Sonar System Design examples.

CRL709 Underwater Electronic Systems

3 Credits, (3-0-0)

Introduction to High Resolution Underwater Imaging Applications, Sidescan Sonar principles, Sector Scan Sonar Principles: Principle of within-pulse scanning, role of grating lobe in sector coverage, Swept-frequency delay line scanning technique, Time-Delay-Integrate scanning technique, Modulation Scanning Technique: Multi-stage scanning, Spatial DFT-based imaging technique, True Phase-Shift beamforming: Near-field focusing, Hilbert-transform based implementation, Synthetic Aperture Sonar: range migration issue, PRF limits, swath coverage, real beam pattern effects, tow-body precision issues, CTFM Sonar, Dual Demodulation CTFM Sonar Phase-Difference based SAS, Radial Projection method of imaging, Monopulse technique, Navigation: Doppler Log, JANUS system, Localization: LBL (Long baseline), SBL (Short baseline), SSBL/USBL (super/ultra short baseline), requirements of tracking and positioning systems, hyperbolic and spherical-based localization using pingers and transponders, Passive Inverse Synthetic Aperture for localizing radiated tonals from moving platforms, Underwater Acoustic Communication Modems and their applications.

CRL711 CAD of RF and Microwave Circuits

4 Credits (3-0-2)

Review of basic microwave theory: Transmission lines-concepts of characteristics impedance, reflection coefficient, standing and

propagating waves, equivalent circuit. Smith chart, Network analysis: Z, ABCD, Y, T, S-parameters, Impedance matching technique, Implementation using simulators. Planar transmission lines. Filters-lumped as well as distributed element realization, Implementation using simulators. Direction couplers and Power divider.

Familiarization of photolithography process, mask making using intellicad and measurement using Automatic Network Analyzer in the laboratory classes. Design, optimization, fabrication and testing of Microstrip components and determining equivalent circuits.

CRL712 RF and Microwave Active Circuits

3 Credits (3-0-0)

Microwave Amplifier theory and design. Theory and design of microwave phase shifters, switches and attenuator. Analysis of microwave mixers.

CRL715 Radiating Systems for RF Communication

3 Credits (3-0-0)

Revision of Maxwell's equations, radiation, Poynting vector; antenna parameters like gain, radiation pattern, VSWR wire antennas – dipole monopole; antenna arrays; aperture antennas and equivalence theorems; printed antennas, scattering.

CRL722 RF and Microwave Solid State Devices

3 Credits (3-0-0)

Review of basics of semiconductor devices. Schottky diode, qualitative description, junction properties, I-V characteristics in forward and reverse biased diodes, high frequency application of Schottky diode, Schottky barrier gate FET. GaAs MESFET I-V characteristics, High Electron Mobility Transistor (HEMT), Hetro-structures, SOI technologies and MOSFETs, Fabrication technologies for GaAs MESFET, MBE, Ion Implantation. Pattern transfer at sub-micron level.

CRL724 RF and Microwave Measurements

3 Credits (3-0-0)

Theory of operation of network analyzer, and spectrum analyzer. VNA calibration, synthesized signal generation, noise measurement, measurement of antenna properties.

CRL725 Technology of RF and Microwave Solid State Devices

3 Credits (3-0-0)

Review of semiconductor device processing technologies: process sequence development for a representative MOS technology, overview of oxidation, diffusion, mask making, pattern transfer, etching, metallization etc., process integration. Techniques of metallization: Introduction to vacuum systems. Sputtering (DC, RF and magnetron), e-beam evaporation for ohmic and Schottky. Contact formation, silicides for gate and interconnect. Fine line lithography process: optical lithography, x-ray and e-beam lithography, lift-off techniques. Wet and plasma assisted etching techniques, RIE, RIBE. Introduction to Ion Implantation, Molecular Beam Epitaxy. Chemical Vapour Deposition (epitaxial growth, polycrystalline, silicon, dielectric films, flow pressure and plasma chemical deposition), Atomic layer deposition. GaAs MESFET technology.

CRL726 MEMS Design and Technology

3 Credits (3-0-0)

Introduction, origin and driving force for MEMS; extension of IC technologies for MEMS fabrication, major technologies for MEMS: bulk and surface micromachining, LIGA process anisotropic etching of silicon, piezoresistive -piezoelectric effect, piezoresistive silicon based pressure sensor, capacitive pressure sensor, RF switch design, fabrication and characterization, actuation in MEMS, MEMS accelerometer design, fabrication, vibration sensor, energy harvesting devices, piezoelectric materials for MEMS, MEMS based RF and microwave circuits.

CRL727 Introduction to Quantum Electron Devices

3 Credits (3-0-0)

The foundation of quantum electronics; Nanoscale resistors: quantum resistance, quantum conductance; Scattering at quantum levels: quantum contacts, quantum interference, Andreev scattering, spin-dependent scattering; Coulomb blockade, Resonant tunneling, Quantum capacitance, Single electron and tunnel transistors: coulomb blockade memory and logic devices, single electron invertors; Electron transport through single molecule: molecular transistors, memories and switches; Spinning of electron: spin valve and transistors, Sub-band quantum devices: quantum wells, wires and dots, sub band infrared and terahertz detectors; Quantum bit: quantum computers, different types of qubit, initialization, quantum manipulation, readout, charge qubit, phase and flux qubit, spin qubit.

CRL729 Sensors and Transducers

3 Credits (3-0-0)

Introduction to sensors and transducers, basic parameters and principles and applications of various sensors and transducers in characterization of materials, devices, circuits and systems; Acoustic and Ultrasonic sensors and transducers; Magnetic and Electrical sensors and transducers; Thermal sensors and transducers; Radiation including Optical sensors and transducers; Smart Sensors for characterization of RF materials, devices, circuits and systems; Mechanical and Thermal Engineering issues for RF Modules/Instruments; Typical applications and use of transducers in systems/instruments.

CRL731 Selected Topics in RFDT-I

3 Credits (3-0-0)

Advanced course on selected topics of relevance to the RFDT M.Tech. Program.

CRL732 Selected Topics in RFDT-II

3 Credits (3-0-0)

Advanced course on selected topics of relevance to the RFDT M.Tech. Program.

CRL733 Selected Topics in RFDT-III

3 Credits (3-0-0)

Advanced course on selected topics of relevance to the RFDT M.Tech. Program.

CRL734 Selected Topics in RFDT-IV

3 Credits (3-0-0)

Advanced course on selected topics of relevance to the RFDT M.Tech. Program.

CRP718 RF and Microwave Measurement Lab

4 Credits (1-0-6)

Laboratory experiments based on network analyzer, spectrum analyzer, antenna pattern measurement, thermography, data acquisition and digitization.

CRP723 Fabrication Techniques for RF and Microwave Devices

3 Credits (1-0-4)

Concept of process flow in IC fabrication, representative process flow for diode/MOSFET. High temperature processes; oxidation, diffusion, and annealing. Use of masks in IC fabrication, mask design and fabrication., Photolithography processes. Chemical etching processes: dry and wet etching. Vacuum and vacuum systems. Thin films in IC processing, resistive evaporation, ebeam, RF and DC sputtering processes. Concept of test chip design and process parameter extraction. Practicals: Vacuum system, Thermal evaporation, DC/RF sputtering, Mask making techniques: Coordinatograph/Photo-plotter first Reduction Camera, Step and Repeat process, Photolithography process, Etching techniques, Oxidation/diffusion processes, Diode fabrication, Band Pass filter fabrication, Measurement equipment calibration.

CRS735 Independent Study

3 Credits (0-3-0)

Advanced course on selected topics of relevance to the RFDT M.Tech. Program.

CRV741 Acoustic Classification using Passive Sonar

1 Credit (1-0-0)

The challenges faced by a sonar designer, involved in developing underwater classification systems will be introduced and possible solutions will be discussed. The radiated noise characteristics from marine vessels and the unique characteristics of the acoustic signature with respect to the class of the marine platform will be presented. Recent research work has shown that classical homomorphic signal processing techniques and other channel inversion techniques can be used to significantly reduce the unwanted underwater channel distortions that otherwise affect the classifier performance drastically. The course shall provide insight into some of the methods that can improve sonar classification performance.

CRV742 Special Module in Radio Frequency Design and Technology-I

1 Credit (1-0-0)

Advanced module on selected topics of relevance to the RFDT M.Tech. program.

CRV743 Special Module in Radio Frequency Design and Technology-II

1 Credit (1-0-0)

Advanced module on selected topics of relevance to the RFDT M.Tech. program.

CRD802 Minor Project

3 Credits (0-0-6)

The project work shall be specific to each student.

CRD811 Major Project-I

6 Credits (0-0-12)

The project work shall be specific to each student.

CRD812 Major Project-II

12 Credits (0-0-24)

The project work shall be specific to each student.

CRD814 Major Project-III

6 Credits (0-0-12)

The project work shall be specific to each student.

Centre for Atmospheric Sciences

ASL320 Climate Change: Impacts, Adaptation and Mitigation

4 Credits (3-0-2)

Elements of physical climatology, climate variability; anthropogenic causes of climate change; concepts of radioactive forcing climate feedbacks and climate sensitivity; Observed climate record and paleo reconstruction, modeling aspects of the climate system; Carbon emission pathways, scenario development, climate simulations of the future; Socio-economic impacts, quantifying uncertainties, tipping points and irreversible changes; Observed and projected changes in weather, monsoons, teleconnections, extreme weather events, sea level in India; Climate hot spots, sector wise vulnerability and adaptation; Reducing greenhouse gas emissions, clean energy technologies, geoengineering options.

ASL340 Fundamentals of Weather and Climate

3 Credits (3-0-0)

Composition of atmosphere, observations, Equations of state; Solar radiation and seasons, energy balance and temperature; Thermodynamic state of atmosphere, Clouds and precipitation processes; Fundamental forces in the atmosphere and ocean: Pressure gradient, gravitational, Coriolis and frictional forces, Atmospheric chemistry: gas phase chemical reactions, tropospheric and stratospheric chemistry, thermodynamic diagrams, General circulation in the atmosphere, small and large weather systems; weather maps, science of weather forecasting, measures of forecasting using skill scores; air-sea interaction and its role on weather and climate; Climate and controlling factors, The Koeppen system, tropical climate.

ASL350 Introduction to Oceanography

3 Credits (3-0-0)

The course begins with a description of structure, formation, and evolution of ocean basins which extends to important features of each ocean basin. The physical, chemical, and biological properties of seawater and their distribution are covered next. Optical and acoustic properties of the sea and their applications are covered; Relations of ocean currents and waves with the driving forces, Effect of ocean basins on oceanic motions; Properties of wind waves, internal waves, Tsunamis, and Tides; Mechanisms of transport of energy, momentum, and physical substances within and across ocean basins; Coastal ocean processes and transport of sediments; Biological productivity of oceans and marine organisms, Marine pollution and oil spill; Topics of current interest such as ocean's role in climate, global warming, sea-level rise, storm surge and Tsunami warning, fisheries, and renewable energy from oceans are presented.

ASL360 The Earth's Atmosphere: Physical Principles

3 Credits (3-0-0)

This course is on the physical principles of the Earth's atmosphere. The course will begin with the forces and energy governing the atmospheric flows and regulating the weather and climate of the planet. Physical processes such as atmospheric convection will be discussed in great detail. How the atmospheric flows transport mass, momentum, and energy in space will be described. The general features of the today's atmosphere will be explained. Emphases will be given on the need and art of atmospheric modeling and future projection of the atmosphere for the next century. The course is very conceptual in nature with a strong research flavour, and will introduce undergraduate students to the art of research in context of the subject.

ASL370 Indian Monsoon, Global Warming, and Climate Change

3 Credits (3-0-0)

Introduction to Monsoon, Monsoon systems across the globe (Indian Monsoon, East Asian monsoon, West African monsoon, South and North American monsoon), Physical principles that are driving the Indian monsoon system, Atmospheric circulation or dynamics associated with the Indian monsoon system, How teleconnections (climate variability in other parts of the world such as PDO, ENSO, etc.)

could possibly influence the Indian monsoon system, Introduction to climate models for simulating and predicting the Indian monsoon system and its variability, Inter-annual to decadal variability of the monsoon system, Seasonal prediction of monsoon, Intra-seasonal variability of monsoon (Active and Break periods), Long term (multi-decadal to century scale) variability of monsoon, Tropical cyclones over the monsoon region, Changing monsoon under changing climate, Natural versus Anthropogenic climate change, Global warming and its causes, Evidences of global warming evidences (sea level rise, retreat of glaciers, surface temperature increase), Linkages between global warming and climate change, Observed climate change over the monsoon region, Assessing changing monsoon using models and observations, climate change and global warming implications for the future of monsoon, Challenges involved in forecasting the monsoon and its variability. Future directions in monsoon research.

ASL380 Climate Modeling

3 Credits (3-0-0)

Basics of the climate system and introduction to climate modeling. Conservation of mass, momentum, and energy; horizontal and vertical energy transfer, moist processes, and wave processes.

Numerical Modeling (Model overview, initial and boundary conditions, numerical techniques, parameterization of sub-grid scale processes, hierarchy of models, simulation, tuning, validation, and verification)

Case studies (Phenomenological and process studies, viz. influence of mountains and surface temperature on atmospheric circulation and precipitation distributions, etc.; modeling of climate change due to doubling of CO₂, etc.)

ASD390 Minor Area Project

5 Credits (0-0-10)

Theoretical, applied and design problems in atmospheric and oceanic sciences will be explored by the student and discussed with the faculty. The problem will be defined and student will carry out relevant literature survey. The student will collect the required data, do the analysis and produce results during entire semester. Progress of student will be evaluated through student seminar and report.

ASL730 Introduction to Weather, Climate and Air Pollution (Not allowed for : Any program other than AST and ASZ)

1 Credit (1-0-0)

Overview of the discipline, history and landmarks, career options, weather vs climate, online resources; composition of the atmosphere, Greenhouse Effect, Ozone Hole, vertical structure of the atmosphere and oceans; energy in the atmosphere, mechanisms of radiative transfer; water in the atmosphere, origin and types of clouds and precipitation; atmospheric and oceanic motion, forces, major wind patterns and ocean currents, monsoons, local circulations, scales of motion; climate and climate change, IPCC; air pollution, pollutants, acid rain, plumes, effects of wind and stability, episodes; observation tools including AWS, radar, satellite; weather and climate models, NWP, chaos theory; field trip to IMD and Hindon AFB to see meteorological instruments in operation.

ASP731 Data Analysis Methods for Atmospheric and Oceanic Sciences (Not allowed for : Any program other than AST and ASZ)

2 Credits (0-0-4)

Introduction to UNIX/LINUX, basic commands, file management; introduction to MATLAB, using Mathworks resources; MATLAB I/O with NetCDF, HDF and GRIB2; plotting 1, 2 and 3 dimensional weather/climate data and animations with MATLAB; Univariate & bivariate statistics, mean/median/mode, variance/standard deviation, correlation, errors, regression; probability and distributions, how to frame and test a hypothesis, principles of statistical significance, using MATLAB functions to test hypotheses and estimate statistical significance; working with spatial weather/climate data, regridding meteorological station data, interpolation, map overlays; working with time-series, interpolation, estimating trend in weather/climate variables.

ASL732 Mathematical and Computational Methods for Atmospheric and Oceanic Sciences (Not allowed for : Any program other than AST and ASZ)

3 Credits (2-0-2)

Elements of FORTRAN programming; Initial and boundary value problems; second order ordinary differential equations, variation of parameters, orthogonal functions; Partial differential equations and their classification, method of separation of variables; Euler and RungeKutta methods for ODE; Spatial and temporal finite differencing schemes of various orders, comparison with exact solutions, accuracy and numerical stability, limitation of finite difference methods; Numerical solution of linear advection equation, advection-diffusion equation, and shallow water equation.

ASL733 Physics of the Atmosphere

3 Credits (3-0-0)

Structure of the atmosphere; Hydrostatic equilibrium, Geopotential, Hypsometric equation and scale height, Altimetry; Adiabatic processes, Lapse rates, Static stability, dynamic stability; Atmospheric Boundary Layer Structure and evolution, turbulence etc.

Atmospheric Thermodynamics: Thermodynamic laws; Thermodynamics of water vapour and moist air: Moisture parameters, Saturated adiabatic and Pseudoadiabatic processes, Conditional and convective instability, Free and forced convection; Thermodynamic diagrams; Phase change and Clausius-Clapeyron equation; Clouds: Formation and classification, Precipitation; Atmospheric visibility: Dew, Frost and fog, smog etc.

The fundamental physics of radiation: solar and terrestrial radiation, radiation laws; absorption, emission and scattering in the atmosphere, Schwarzschild's equation; Radiation in the earth-atmosphere system: Geographical and seasonal distribution, Radiative heating and cooling of the atmosphere, Surface energy budget, The mean annual heat balance.

ASL734 Dynamics of the Atmosphere

3 Credits (3-0-0)

Fundamental forces; basic laws of conservation; hydrodynamic equations in rotating frame of reference; dimensional analysis; geostrophic and hydrostatic approximations; Atmospheric stability; Isobaric coordinate system; Gradient wind approximation; thermal wind; vertical motion; barotropic and baroclinic atmospheres; Circulation and vorticity; vorticity equation; potential vorticity conservation. Boussinesq approximation; Reynolds averaging; mixing length hypothesis; Ekman layer; Acoustic, gravity, Poincare, Rossby and Kelvin waves. Atmospheric general circulation.

ASL735 Atmospheric Chemistry and Air Pollution

3 Credits (3-0-0)

Atmospheric Composition and air pollutants, Geochemical cycles: Evolution of the atmosphere and geochemical cycling of elements; Atmospheric photochemistry; Chemistry of the troposphere: Basic photochemical cycle, atmospheric chemistry dealing with various pollutant species and photochemical smog; Oxidising power of the troposphere and the Hydroxyl radical, global budgets of precursor species; Stratospheric Chemistry and Ozone: Overview, Chapman mechanism, reservoir species and catalytic cycles, Ozone hole and polar stratospheric clouds, Arctic Ozone loss, Ozone depletion potential; Aqueous phase atmospheric chemistry and acid rain; Atmospheric Aerosols: sources and characteristics, radiative effects and perturbation to climate; Atmospheric air pollutants: sources, impacts and standards; Air Pollution Meteorology: sources of air pollutants, classification and air quality standards, stability conditions, wind velocity profile, turbulence, mixing depth, characteristics of stack plumes; Dispersion of pollutants in the atmosphere: A Gaussian dispersion model, dispersion parameters and effective stack height.

ASL736 Science of Climate Change

3 Credits (3-0-0)

Description of the climate system (General circulation, hydrological cycle, carbon cycle). Natural greenhouse effect and the effect of trace gases and aerosols. Forcings (natural & anthropogenic), Fast and

Slow Feedbacks, Equilibrium Climate Sensitivity, Transient Climate Response. Climates of the past (ice ages, proxy records, abrupt climate change, instrumental record of climate). Climate variability and time-scales; MJO, ENSO, PDO, Milankovic cycles. Modeling climate: Simple EBMs, Coupled Climate Models. Natural and Anthropogenic climate change. Future climate projections.

ASL737 Physical and Dynamical Oceanography

3 Credits (3-0-0)

Properties of sea water; temperature and salinity distributions; stratification and stability of oceanic water column; equation of state of sea water; oceanic mixed layer processes; governing equations for oceanic motions; inertial and geostrophic currents; wind-driven circulation; thermohaline circulation; Barotropic and baroclinic transports; western boundary intensification; gyres and meso-scale eddies; gyre systems, major currents in world oceans; Indian ocean circulation; physics and dynamics of ocean wind waves, internal waves and tides; coastal ocean processes; upwelling and downwelling in coastal and equatorial oceans; Rossby and Kelvin waves, biological productivity of oceans; heat and salt budget of oceans; observational methods in oceans; storm surges, ENSO and IOD phenomenon.

ASL738 Numerical Modeling of the Atmosphere and Ocean (Not allowed for : Any program other than AST and ASZ)

3 Credits (2-0-2)

Introduction to weather and climate models, Numerical Modeling Vs. Other Modeling Approaches, Examples of atmospheric and oceanic simulations, Model Hierarchy (Simple, Intermediate, Complex); Governing equations in Cartesian, Isobaric and sigma coordinate systems; Numerical discretization (finite difference, finite volume, spectral) and integration, stability, CFL criterion, unconditionally stable numerical scheme; model components, dynamical core, physical parameterization, tracers, coupling of components; global and regional models used in weather forecasting and climate simulations.

ASL750 Boundary Layer Meteorology

3 Credits (3-0-0)

Introduction to the boundary layer, definition and qualitative description of temporal evolution and vertical structure; Fourier series and turbulence spectra, Reynold's averaging, interpreting variance/covariance as turbulent kinetic energy and fluxes, tensors and Einstein summation notation; Prognostic equations for mean variables in a turbulent flow, simplifications; Prognostic equations for turbulent fluxes and variances; TKE equation, static and dynamic instability, Reynold's number, Richardson number, Obukhov length, stability parameter relationships, closure problem in turbulent flow, first-order local closure; surface boundary conditions, surface momentum, energy and moisture budgets, fluxes at surface and entrainment zone, drag and Bowen ratio methods; surface layer Similarity Theory, Buckingham Pi method, applications to wind profiles; Stable and convective mixed layer phenomena including nocturnal jets, thermals, dust devils; boundary layer clouds, fair-weather cumulus, fog; geographically generated local circulations like slope and valley winds, sea/lake breeze, geographically modified flow, fetch, internal boundary layer.

ASL751 Dispersion of Air Pollutants

3 Credits (3-0-0)

Air Pollution, Various types, sources and effects of pollutants in the atmospheric environment; Particulate matter and atmospheric visibility; Atmospheric diffusion theories and types of dispersion models; Lapse rates and various types of stability classification, Wind-profile, Wind rose, Mixing Depth, General characteristics of the stack plumes; Dispersion of pollutants in the atmosphere and solution of advection diffusion equation with Gaussian distribution for point, line and area sources, plume rise, dispersion parameters and various methods of their evaluation; Atmospheric Removal processes and residence time; Effect of buildings and topography on dispersion; Similarity theory and profiles in the surface layer; Air Quality and Emission standards, their measurements and statistics; Introduction of air quality models for regulatory applications.

ASL752 Mesoscale Meteorology*3 Credits (3-0-0)*

Overview of mesoscale phenomena relevant to India including tornadoes, thunderstorms, cloud bursts, fog, extreme rain events, lightning, etc; Circulation systems related to orography, mountain drag, mountain waves, valley winds, valley air pollution; Adiabatic mesoscale perturbations in a straight atmospheric flow; Theory of linear gravity waves, orographic gravity-wave drag; Parameterization of mesoscale phenomena in general circulation models; Mesoscale models and their application in India.

ASL753 Atmospheric Aerosols*3 Credits (3-0-0)*

Introduction to atmospheric aerosols; Characterization of Aerosols; Physical and Optical properties of aerosols, size distribution, refractive indices of aerosols, absorption and scattering of radiation by aerosols; single scattering albedo, aerosol optical depth, aerosol phase function, hygroscopic growth; mixing state, vertical distribution in the atmosphere; Aerosol Chemical Composition; mixing state of aerosols; New particle formation; volatile chemical compounds and gas-to-particle conversion processes; Observations and Measurements of aerosols; Climatology of Tropospheric Aerosols; Stratospheric aerosols; Dynamics of single aerosol particle and aerosol population; Transport and transformation of aerosols; Removal of aerosols; Thermodynamics of aerosols; Role in Nucleation; Role in Cloud Physics; Interaction of aerosols with radiation; Direct, indirect, and semi-direct effects of aerosols and their influence on Climate; Aerosol effects on human health and air quality; Aerosols in chemistry transport models; Aerosols in climate models; Latest trends in aerosol research and future directions.

ASL754 Cloud Physics*3 Credits (3-0-0)*

Cloud types; cloud formation; cloud dynamics: entrainment, detrainment and downdraft initiation in cumuli, large scale convergence, mesoscale convective system; Kohler theory; CCN and IN; homogeneous and heterogeneous nucleation; fundamental equations governing cloud processes; warm cloud microphysics: diffusional growth, droplet population, collision-coalescence, radiative cooling; ice cloud microphysics: nucleation, ice multiplication, growth of ice particles by accretion and ice particle melting; hydrometeor; impact of microphysical processes on dynamics; cloud chemistry; aerosol-cloud interaction: direct, indirect and semi-direct effects; clouds in numerical models: parameterization of cloud microphysics; cloud-climate interaction.

ASL755 Remote Sensing of the Atmosphere and Ocean*3 Credits (3-0-0)*

Basics of satellite remote sensing: satellite orbits, sensor characteristics, view angle, passive and active remote sensing; atmospheric radiative transfer application in retrievals of geophysical parameters; aerosol remote sensing using ground-based (passive radiometer and lidar) and satellite platforms, retrieval algorithm, vertical distribution, application of aerosol products in climate studies; cloud remote sensing, cloud detection using multi-spectral technique, issues in cloud-masking, CO₂ slice technique; trace gas retrievals; ocean colour remote sensing, SST retrieval, wind scatterometry, altimetry; microwave remote sensing: soil moisture retrieval, passive (brightness temperature) and active (radar) microwave remote sensing for precipitation, sounding, remote sensing of cryosphere; satellite meteorology for extreme weather events (e.g. cyclone, thunderstorms etc.); land-use/land-cover change; hydrological application using gravity anomaly from satellites.

ASL756 Synoptic Meteorology*3 Credits (3-0-0)*

Different scales of atmospheric motion; Different types of air masses and tropical weather systems; Western disturbances and monsoonal cyclonic systems, Meteorological charts and diagrams, map projections, plotting of synoptic maps; Analysis of sea level pressure

patterns, pressure tendency, surface temperature and dew point, stream lines and wind patterns, temperature patterns and isotach; Analysis of the vertical structure of the atmosphere.

ASL757 Tropical Weather and Climate*3 Credits (3-0-0)*

Overview; Structure of the tropical atmosphere; Role of the Tropics in the Global Mass, Momentum, and Energy Balance; Tropical Circulation & Mean Precipitation Distribution; ITCZ (Inter-tropical Convergence Zone); Tropical Waves and Tropical Variability (Intra-seasonal: MJO (Madden-Julian Oscillation), CCEWs (Convectively Coupled Equatorial Waves), Inter-annual: ENSO (El Niño Southern Oscillation), QBO (Quasi-biennial oscillation), Decadal: PDO (Pacific Decadal Oscillation), AMO (Atlantic Multi-decadal Oscillation), NAO (North Atlantic Oscillation)); Monsoons (Mean and variability); Tropical Cyclones; Modeling of the Tropical Climate & Weather.

ASL758 General Circulation of the Atmosphere*3 Credits (3-0-0)*

General Principles of Atmospheric Motion (Simplifications of Force Balances Important to Large-scale Motions, Large-scale Structures in the Atmosphere, Simplifications for Large-scale Vertical Structure, Scale Analysis of the Tropics), General Circulation of the Atmosphere (Historical Evolution of Global Circulation Conceptual Models, Axisymmetric Hadley Cell: Theories and Assumptions, A Road Map to the Tropics and Subtropics, Walker circulation, Comparing the Tropics and Midlatitudes, Stratospheric Circulations), Surface ocean circulation, Atmospheric response to Equatorial Heating, Monsoons (Defining the Monsoon, A Conceptual Model of Monsoon Evolution, Evolution of the South Asian Monsoon System, Other Monsoons Around the World, Australian-Maritime Continent Monsoon, West African Monsoon, Monsoons in the Americas), General Circulation Modeling (Basics of an atmospheric general circulation model, Representation of physical processes in GCMs, analysis of GCM simulations and comparison with observations, challenges for improving GCM simulations).

ASL759 Land-Atmosphere Interactions*3 Credits (3-0-0)*

Introduction: components of the Earth System, energy, hydrologic and biogeochemical cycles; Weather and climate processes including atmospheric boundary layer, convection, clouds and precipitation, surface energy and moisture fluxes, climate, climate variability; Canopy-air interactions: canopy processes, observations, big leaf models, canopy models; Terrestrial hydrology: watershed hydrology, river routing models; Soil: soil physics, soil moisture, soil biogeochemistry, soil models; Carbon cycle: photosynthesis, vegetation dynamics, global biogeography, carbon cycle models; Terrestrial forcings: landscape heterogeneity, landscape induced and modified flow, feedbacks, land models, coupled Earth System models; Land-use/land-cover change: Deforestation, agriculture, urbanization, forest fires, effects on weather and climate.

ASL760 Renewable Energy Meteorology*3 Credits (3-0-0)*

Introduction to the atmosphere: weather and climate processes; Solar radiation and surface energy balance: Solar constant, solar geometry, atmospheric radiative transfer, clouds and aerosols, surface energy budget, urban energy use, sensors and observations; Meteorological considerations for solar power: solar resource assessment, solar forecasting for different timescales, uncertainty estimation, types of solar systems; Wind in the atmospheric boundary layer: boundary layer structure and evolution, surface layer, stability, log and power laws, flow over complex terrain, low-level jets, offshore winds, sensors and observations; Meteorological considerations for wind power: wind resource assessment, wind forecasting for different timescales using statistical and numerical methods, uncertainty estimation, types of turbines, turbine wakes, wake interactions in wind farms, turbine and wake models, LES and mesoscale models of wind farms; Solar-wind coupling: resource variability, power demand, optimization.

ASL761 Earth System Modeling**3 Credits (3-0-0)**

Basics of Earth System Science (Earth system components, Physical phenomena in the Earth system, Globally averaged energy budget, Energy transports by atmosphere and ocean, concepts of radiative forcing, feedbacks and climate change), Physical Processes in the Earth System and governing principles (Equation of state, Continuity equation, Conservation of momentum, Temperature equation, Moisture equation and salinity equation, Moist processes, Wave processes in the atmosphere and ocean), Representation of Physical processes in Earth System Models (Treatment of sub-grid scale processes such as dry convection, moist convection, land surface, snow, ice and vegetation; Radiation, greenhouse gases, aerosols and other climate forcings), Biogeochemical and Biophysical Processes, coupling between physics packages, Dynamics in Earth System Models (Dynamical core, Grid scale processes, Numerical representation of the grid scale processes, Grids, Resolution, Accuracy, Efficiency, and Scalability), Earth system model simulations (Climate simulations and climate drift, Verification and Validation of simulations with observations, Emission Scenarios & forcings, Global-average response to greenhouse warming scenarios, Transient climate change versus equilibrium response experiments, Trends & natural variability, scale dependency of simulations, Multi-model simulations & ensemble averages, Simulation examples from Coupled Model Inter-comparison Project).

ASL762 Air-Sea Interaction**3 Credits (3-0-0)**

State of matter near the air-sea interface, marine boundary layer, transfer properties between atmosphere and ocean, solar and terrestrial radiation, sea surface radiation budget, surface wind waves, air-sea interaction processes using examples of ENSO, hurricane, Indian monsoon, turbulent transfer near the interface, bubbles and spray, transport of trace gases across the interface; latent, sensible, and momentum fluxes in the surface boundary layer over the sea, bulk parameterizations, large-scale forcing by sea surface buoyancy fluxes, spatio-temporal variability of ocean surface fluxes with reference to Indian ocean.

ASL763 Coastal Ocean and Estuarine Processes**3 Credits (3-0-0)**

Wave generating and restoring forces, shallow water waves, coastally trapped long waves, influence of sea-bed friction, Wave spectra, Refraction and shoaling of waves, Seiches, waves-current interaction, wave transformation in shallow waters, Tsunamis, Breaking waves, Phenomenon of wave reflection, refraction, and diffraction, Surf zone hydrodynamics, shoreline setup, Swash and runup heights, wave generated alongshore currents, Rip currents, Storm surges, theory of tides, Tides in rivers and coastal lagoons, General characteristics of estuaries, Classification of estuaries, stratification, estuarine circulation and mixing, Shear instability at an interface, Entrainment and sedimentation in estuaries, Dispersion processes: Advective and turbulent diffusion, River-estuary-near-shore systems, Sediment characteristics, Sediment transport mechanisms: bedform dynamics, suspended particles in wave flows and vortices, Morpho-dynamics: Beach profiles, Tide range influence on beach morphology, Lee side erosion, Beach realignment due to climate change, Interaction of an estuary with the near-shore bay.

ASS800 Independent Study**3 Credits (0-3-0)**

To be given by the interested faculty.

ASP820 Advanced Data Analysis for Weather and Climate (Not allowed for : Any program other than AST and ASZ)**3 Credits (1-0-4)**

Weather Forecast Evaluation: Jet stream analysis, standard diagnostics and skill scores, Extreme events analysis. Using correlation to explore the relationships between large-scale atmospheric conditions, and

local weather. Analyzing trends in climate data, and determining if they are statistically significant (regression, Mann-Kendall test etc). Regression based approaches, simple linear & multiple. Using indexes, Compositing patterns, Isolating patterns using EOF/PC analysis; Analysis of Time Series, Autocorrelation and Spectra.

ASL821 Advanced Dynamic Meteorology**3 Credits (3-0-0)***Pre-requisite(s): ASL734*

Quasi-geostrophic motions in the atmosphere: circulation and vorticity; Ertel-Rossby invariants; Ertel's potential vorticity conservation theorem; Kelvin and Bjerknes-baroclinic circulation theorem; quasi-geostrophic turbulence. Instabilities in the atmosphere: barotropic and baroclinic instability; symmetric instabilities. Quasi-geostrophic motions in equatorial region, heat-induced tropical circulations: monsoons, El Nino and Madden-Julian Oscillation. Waves in the atmosphere: Kelvin, Rossby and Poincaré waves, Lamb wave, internal gravity waves, vertically propagating waves, Rossby adjustment theory. Middle atmosphere dynamics: sudden atmospheric warming, QBO. General circulation of the atmosphere: analysis of surface pressure and associated wind circulation, upper-tropospheric (200hPa) circulation; scale analysis, formulation of the governing set of equations for a weather prediction model.

ASL822 Climate Variability**3 Credits (3-0-0)**

Major modes or patterns of climate variability on intraseasonal to interannual and decadal time scales. Well-known modes including Madden-Julian Oscillation, El Nino-Southern Oscillation, Pacific Decadal Oscillation, Atlantic Multidecadal Oscillation, Indian Ocean Dipole, Monsoon, North Atlantic Oscillation, and Annular Modes (Arctic and Antarctic Oscillation) and their impacts on extreme weather and climate. The course will review climate mode/pattern dynamics, their teleconnection mechanisms and impacts on weather/climate such as droughts etc. Temporal behavior –including how these modes have changed in the past, and how anthropogenic climate change may affect future mode behavior). Discussion of predictability of climate modes/patterns on seasonal to interannual time scales. Detection and attribution of climate change.

ASL823 Geophysical Fluid Dynamics**3 Credits (3-0-0)**

(i) Fundamental concepts in geophysical fluid dynamics: equations of motion on a rotating planet, vorticity and circulation, conservation of potential vorticity, thermal wind, Taylor-Proudman theorem; Ertel-Rossby invariants; Ertel's potential vorticity conservation theorem; consequences of geostrophic and hydrostatic approximation. (ii) Shallow-water theory: derivation of shallow-water equations; derivation of vorticity equation; linearized form of shallow-water equations; plane waves in a layer of constant depth; dispersion diagrams of Kelvin and Poincaré waves. (iii) Rossby wave theory: mechanism of Rossby wave generation; inertial boundary currents; derivation of potential vorticity on beta-plane; quasigeostrophic scaling; Rossby waves in a zonal current; method of multiple scales for linear potential vorticity equation; reflection and radiation of Rossby waves; generation of Rossby waves by an initial disturbance; Quasigeostrophic normal modes in a closed basin; resonant interaction; energy and enstrophy conservation; upscale energy transfer. (iv) Friction effects in geophysical flows: Turbulent Reynolds stresses; Ekman layers in a homogeneous, incompressible rotating fluid; Ekman layer on a sloping surface; quasigeostrophic potential vorticity with friction and topography. (v) Instability theory: linear stability; normal modes; growth rates; baroclinic instability; Eady model and Charney model; instability in a two-layer model.

ASL824 Parameterization of Physical Processes**3 Credits (3-0-0)***Pre-requisite(s): Any one of ASL733, ASL734*

A simple model of atmosphere with Rayleigh friction and Newtonian cooling; Gill's analytical solutions for heat-induced tropical circulations

(especially El Niño and monsoon circulation); horizontal diffusion in NWP models: prevention of accumulation of small scale noise, inverse cascade. Aerodynamic formulae for surface turbulent fluxes, vertical turbulent diffusion: one-dimensional PBL model. Parameterization of orographic drag. Dry and moist processes in the atmosphere: a simple model of convection, dry adiabatic adjustment, large-scale condensation, and parameterization of deep and shallow convection. Simple and complex radiative transfer in the atmosphere; absorption of radiation by ozone, carbon dioxide and water vapour; shortwave and longwave radiation computation; radiative heating in the atmosphere.

ASP825 Mesoscale Modeling (Not allowed for : Any program other than AST and ASZ)

3 Credits (0-0-6)

Introduction to the Weather Research and Forecasting (WRF) model and parallel computing; Install WRF, NCL and associated libraries; Conduct test simulations for 2-d idealized cases such as flow over a hill, sea-breeze, etc., configure and conduct test simulations for a full 3-d real case, conduct numerical experiments by changing initial & boundary conditions and namelist parameters/flags; Understand WRF code structure and registry by adding new variables into different modules; Introduction to parameterizations in WRF, explore the science and the codes of a land surface scheme and a cumulus scheme, make simple modifications to the schemes, conduct numerical experiments with modified schemes.

ASL826 Ocean Modeling (Not allowed for : Any program other than AST and ASZ)

3 Credits (2-0-2)

Introduction to ocean dynamics, governing equations of oceanic motions, numerical methods in ocean modelling, hydrostatic and non-hydrostatic phenomenon, barotropic and baroclinic processes, lateral and open boundary conditions, parameterization of sub-grid scale processes, large scale ocean circulation, modelling of shelf circulation, tides and storm surge modelling, regional and coastal ocean models, shallow water models, multi-level basin scale and global ocean models, ocean wave modelling, introduction to data assimilation techniques.

ASL827 Advanced Dynamic Oceanography

3 Credits (3-0-0)

Pre-requisite(s): Either ASL734 or ASL737

Conservation laws for moving fluids, Ekman and Sverdrup theories, coastal upwelling and fronts, Western boundary intensification, barotropic currents, baroclinic transport over topography, thermohaline circulation, Mesoscale eddies and variability. Indian ocean circulation, wave theory, ocean wave spectra, wave energy equation, breaking waves, reflection and dissipation, theory of tides, tidal currents, tidal processes in embayment and estuaries, wind and buoyancy driven currents, near-shore circulation, alongshore currents, wave-current interaction, sediment transport, coastal ocean response to extreme wind forcing, storm surges, Planetary and equatorial waves, coastally trapped Kelvin waves.

ASL851 Special Topics in Climate

3 Credits (3-0-0)

To be given by the interested faculty.

ASL852 Special Topics in Oceans

3 Credits (3-0-0)

To be given by the interested faculty.

ASL853 Special Topics in Atmosphere

3 Credits (3-0-0)

To be given by the interested faculty.

ASL854 Special Topics in Air Pollution Studies

3 Credits (3-0-0)

To be given by the interested faculty.

ASP855 Special Topics in Atmosphere and Ocean (Not allowed for : Any program other than AST and ASZ)

3 Credits (1-0-4)

To be given by the interested faculty.

ASL856 Special Topics in Atmospheric and Oceanic Observations (Not allowed for : Any program other than AST and ASZ)

3 Credits (2-0-2)

To be given by the interested faculty.

ASV862 Special Module in Climate

1 Credit (1-0-0)

To be given by the interested faculty.

ASV863 Special Module in Oceans

1 Credit (1-0-0)

To be given by the interested faculty.

ASV864 Special Module in Atmosphere

1 Credit (1-0-0)

To be given by the interested faculty.

ASV865 Special Module in Air Pollution Studies

1 Credit (1-0-0)

To be given by the interested faculty.

ASV866 Special Module in Atmosphere and Ocean

1 Credit (1-0-0)

To be given by the interested faculty.

ASP867 Special Module in Weather Forecasting (Not allowed for : Any program other than AST and ASZ)

1 Credit (0-0-2)

To be given by the interested faculty.

ASP868 Special Module in Atmospheric and Oceanic Observations (Not allowed for : Any program other than AST and ASZ)

1 Credit (0-0-2)

To be given by the interested faculty.

ASC869 Atmospheric and Oceanic Science Colloquium (Not allowed for : Any program other than AST and ASZ)

1 Credit (0-1-0)

To be given by the interested faculty.

ASD881 Project-I (Not allowed for : Any program other than AST and ASZ)

6 Credits (0-0-12)

To be given by the interested faculty.

ASD882 Project-II (Not allowed for : Any program other than AST and ASZ)

12 Credits (0-0-24)

Pre-requisite(s): ASD881

Centre for Automotive Research and Tribology

CTP702 Electric Vehicle Laboratory I

3 credits (1 0 4)

Charging infrastructure and notion of battery swapping; Charging interfaces; Battery testing; Single cell performance; charge-discharge tests; capacity retention test; electrochemical testing; EIS; etc. Battery management system (BMS) testing; Over protection; Over current; Short circuit tests; Over voltage tests; Module design and testing; electromechanical assembly of cells; welding of cells; BMS design and integration in Module; Power train architecture. DC-DC converters; Isolated gate driving techniques; Winding diagram and development of induction machine; PWM techniques; Charge balancing circuits; Power train testing; Converter testing; Control of drives.

ITL702 Diagnostic Maintenance and Condition Monitoring

4 Credits (3-0-2)

Maintenance strategies and introduction to Condition Based Maintenance (CBM), Application and economic benefits, Signature analysis - online and off-line techniques, Various Condition Monitoring (CM) techniques - Vibration monitoring and analysis, Shock Pulse Method, Noise monitoring, Envelope detection technique, Cepstrum analysis, Oil analysis including wear debris and contaminant monitoring, Performance monitoring, Acoustic emission and other techniques, Non-destructive testing techniques, Temperature monitoring including Thermography, Application and choice of the method, Practical applications of diagnostic maintenance, Condition monitoring of mechanical and electrical machines, Case studies.

CTL703 Introduction to Electric Vehicles

3 credits (3 0 0)

Introduction to HEV, PHEV, and EV Powertrain, Fuel cell vehicles; comparison between ICE and EV- operating principles, emission control; Overview of Indian and international regulatory requirements for EV - AIS-048 BOV (battery operated vehicle); Fundamentals of Vehicle Propulsion; Electric Propulsion System - drives; Hybrid Electric Vehicles – series, parallel hybrid power trains; Energy Storage for EVs – Battery, Ultracapacitors, Fuel cells; Battery Management System (BMS); Chargers and charging infrastructures, Battery swapping stations, Controllers, sensors and communication protocols; EV Telematics; Fundamentals of Regenerative Braking; Modelling and simulation of EVs; Design examples for HEV, EVs.

ITL703 Fundamentals of Tribology

4 Credits (3-0-2)

Introduction to tribology and its historical background. Factors influencing Tribological phenomena. Engineering surfaces – Surface characterization, Computation of surface parameters. Surface measurement techniques. Apparent and real area of contact.

Contact of engineering surfaces- Hertzian and non-hertzian contact. Contact pressure and deformation in non-conformal contacts. Genesis of friction, friction in contacting rough surfaces, sliding and rolling friction, Various laws and theory of friction. Stick-slip friction behaviour, frictional heating and temperature rise. Friction measurement techniques. Wear and wear types. Mechanisms of wear - Adhesive, abrasive, corrosive, erosion, fatigue, fretting, etc., Wear of metals and non-metals. Wear models - asperity contact, constant and variable wear rate, geometrical influence in wear models, wear damage. Wear in various mechanical components, wear controlling techniques. Introduction to lubrication. Lubrication regimes. Introduction to micro and nano-tribology.

CTP704 Electric Vehicle Laboratory II

3 credits (1 0 4)

Noise, vibration and harshness measurement of EV and its components; Noise Source Characterization of EVs, Condition Monitoring of Automotive Components, Failure analysis of Battery materials (microscopic and macroscopic analysis); Drive cycles for electric vehicles; modelling and simulation of battery (Battery models (electrical; thermal; mechanistic and its simulation) and NVH. Case study of EV platform.

CTL705 Engineering of Electric Vehicles

3 credits (3 0 0)

Introduction to types and working mechanisms of Electric Vehicles, Components of Electric Vehicles, Chassis /Battery/Charger/etc., Standard Materials and its properties for components used in Electric Vehicles, Frame and Chassis of Electric Vehicles, Battery components and its design parameters, battery manufacturing methods, applications and operation of batteries in Electric Vehicles, braking systems in EVs, planetary gears, clutches, differentials, all-wheel drive regenerative braking mechanisms, Brake strategies (Series and Parallel), Braking torque distribution principle, electro-mechanical hybrid braking system, Braking force mathematical model.

ITL705 Materials for Tribological Applications

3 Credits (3-0-0)

Introduction to tribological processes and tribological relevant properties of materials. An overview of engineering materials having potential for tribological application.

Characterization and evaluation of Ferrous materials for tribological requirements/applications, Selection of ferrous materials for rolling element bearings, gears, crank shafts, piston rings, cylinder liners, etc. Non-ferrous materials and their applications such as sliding bearings, piston rings, cylinder liners, etc., materials for dry friction materials. Composite materials (PM, CMC and MMC) for tribological applications. Surface treatment techniques with applications such as carburizing, nitriding, induction hardening, hard facing, laser surface treatments, etc. Surface coating techniques such as electrochemical depositions, anodizing, thermal spraying, Chemical Vapour Deposition (CVD), Physical Vapour Deposition (PVD), etc. and their applications. Lubricants- Introduction, requirements, types, Evaluation and testing of lubricants.

CTL707 Batteries for Electric Vehicles: Multidisciplinary Perspectives

3 credits (3 0 0)

Introduction to Energy Storage Systems (ESS), Types of Batteries, their working mechanisms and characteristics, Applications of Batteries and ultracapacitors in Electric Vehicles, Component sizing and simulations, Comparison between different cell chemistry w.r.t. specific power, specific energy, safety, lifespan, performance, cost etc; Battery design parameters for several Electric Vehicles, Battery Architecture, Battery passive components sizing, Isolation requirements, Manufacturing of batteries, Battery modelling, form cell to pack, Battery pack and design issues, Failures of batteries, Battery Pack Performance & Safety testing standards, Battery management systems, Overview of safety circuits like over voltage and under voltage protection, pre-charge circuit, isolation monitoring, HVIL (high voltage interlock loop), MSD (manual service disconnect), Fuses etc., Overview of favorable and unfavorable storage conditions, impact of temperature on batteries.

CTL709 Charging Infrastructure for EVs

3 credits (3 0 0)

National EV charging station status; Charger types; Charging station types; connectors; Plug-in Charging technologies; Charging Protocols & Connectors: CHAdemo, CCS, GB/T, ChaoJi (upcoming); slow charging; fast charging methods; CAN based and PLC based charging overview; thermal management; active and passive equalization; overview of EVCC (electric vehicle charging controller) and its communication with allied components; Onboard charging & Off board charging technology, requirements, global standards & Indian standards communication between on board charger, controller, BMS, VCU (vehicle control unit) and charging station; Constant current and constant voltage charging during various battery SOC; Sustainable Charging systems; Solar Powered Charging stations; V2H, V2X, Vehicle to Vehicle, Vehicle to Grid, Vehicle to Home, Building & Dynamic load management of chargers.

ITL709 Maintenance Planning and Control

3 Credits (3-0-0)

Objectives of planned maintenance, Maintenance philosophies, Preventive and Predictive maintenance, Emerging trends in maintenance-Proactive Maintenance, Reliability Centred Maintenance (RCM), Total Productive Maintenance (TPM), etc, Implementation of Maintenance strategy, Maintenance organization, Basis of planned maintenance system, Maintenance planning and scheduling, Maintenance control system and documentation. Spares and inventory planning, Manpower planning, maintenance auditing. Human factors in maintenance and training, maintenance costing, Maintenance performance. Repair decisions- Repair, replacement and overhaul, Computer applications in maintenance, Expert systems applications, maintenance effectiveness, Case studies.

ITL710 Design of Tribological Elements

3 Credits (3-0-0)

Introduction-Tribological consideration in design, Conceptual design, Classification of tribological components, Mechanisms of tribological failures in machines, Zero wear concept, Computational techniques in design.

Design of Dry Frictional Elements-Dry friction concepts, Brakes and Clutches, Friction belts and Dry rubbing bearing.

Design of Fluid Frictional Elements- Fluid friction concepts, Design of hydrodynamically loaded journal bearings, externally pressurized bearings, Oscillating journal bearings, Externally pressurized bearings, Design of oil groove, Design of elliptical, multi-lobe and titled pad bearings. Rolling elements bearings, Performance analysis of bearings, gears, seals, piston rings, machine tool slide ways, cams and follower and wire rope.

CTL711 Embedded Systems for Automotive Sector

3 credits (3 0 0)

Power Train Domain; Chassis Domain; Active/Passive Safety; Diagnostic; Architecture Description Languages for Automotive Applications; Objectives and working methods of SAR; Main Areas of AUTOSAR Standardization: Methodology and Templates; AUTOSAR in practice; Road Transport and Its Evolution; Congestion Problem ; Energy and Emissions; Sensor Technologies ; Sensor Fusion ;Wireless Network Technologies ; Intelligent Control Applications ; Latest Driving Assistance; Intelligent Autodiagnostic; Automated road vehicles; road network and road management; In-Car Embedded Networks ; Open Issues for Automotive Communication Systems; Star Topologies and Communication for CAN; Working principle and advantages of ethernet over present LIN and CAN network.

ITL711 Reliability, Availability and Maintainability (RAM) Engineering

3 Credits (3-0-0)

System concepts in RAM Engineering, Fundamentals of reliability, Failure distributions, Statistical analysis of failure data, Weibull analysis, Monte Carlo simulation, System reliability assessment. Reliability of repairable and non-repairable systems. Point, mission and steady state availability. Availability assessment. Maintainability and its assessment. Design for reliability and maintainability, Practical applications of RAM Engineering to systems, products and processes.

CTL713 Connected and Autonomous Vehicles

3 credits (3 0 0)

Automotive Safety Integrity Level; Vehicle System Design and its components, Principles for path planning and decision making, Sensors Technology and Computational Algorithms, Design, Architecture and Evaluation of Automotive Systems, Control Essentials for Automotive Systems, Modelling, Simulation and Optimization for Transportation systems, Advanced Driver Assistance Systems (ADAS), Security Aspects for Connected Vehicles, Safe practices and regulatory standards.

ITL714 Failure Analysis and Repair

4 Credits (3-0-2)

Introduction, need for failure analysis, Classification of failures, Fundamental causes of failures, influence of type of loading (e.g. static, fatigue, shock, etc.) on nature of failures, Role of stress; processing and fabrication defects, Effect of residual stresses induced during fabrication processes, Influence of temperature and

environment on failure, Crack and subsurface crack like defects and their significance in failure.

Micro mechanisms of failures; Ductile and brittle fracture, Fracture initiation and propagation, Fatigue failures, Wear related failures, High temperature failures, low temperature failures, etc., Studies and analysis of failed surfaces.

Identification of failures, Techniques of failure analysis, Microscopic methods, Fracture mechanics techniques, Prediction of failures, Residual life assessment and life extension, Typical case studies in failure analysis, Logical fault finding and its application, Inspection and safety measures, Repair techniques and economic considerations, Failure analysis for design improvement and proactive maintenance, Design for reparability, Case Studies.

CTL715 Electric Energy Storage Systems

3 credits (3 0 0)

Energy storage systems for electric transportation, smart grid, and renewable energy systems; working principles of batteries (various chemistries), high power ultra capacitors, and energy dense fuel cell systems; battery energy management techniques as well as ultra capacitor power management techniques; power electronics for energy and power management; Hybrid energy storage systems and controller development; charging and infrastructure design.

CTL 717 Power Electronics and Drives for Electric Vehicles

3 credits (3 0 0)

Global overview of Transportation electrification, Role of Power Electronics and Drives in Transportation Electrification; Vehicle system dynamics; Introduction to Electromagnetic Energy Conversion; Electric drivetrain system; System design considerations, rating and sizing of electric drivetrain components; Machines and drives for traction and EVs: BLDC, PMSM, IM, SRM; Control of Electric Drives; Starter-generators in HEV; Battery Charging; Bidirectional DC-DC converters; Control of grid-connected converters; Architectures, modelling and simulations of electric drivetrains, Case study; Railway Traction, Aircraft Power Generation.

ITL717 Corrosion and its Control

3 Credits (3-0-0)

Importance of corrosion control in industrial practices, Thermodynamics of corrosion, Broad forms of corrosion – uniform, uneven, pitting, cracking, etc. influencing factors on corrosion. Surface film, Polarisation and effect, Theory of passivity, kinetics of corrosion, Various types of corrosion along with case studies – Galvanic, Thermogalvanic, High temperature corrosion, Intergranular, Pitting, Selective attack (leaching), fretting corrosion – erosion, cavitation, Stress corrosion cracking, hydrogen embrittlement, etc., Various techniques for corrosion evaluation and monitoring, Corrosion Control-Design improvement, Selection of material, fabrication process for corrosion control, Role of residual stress, Changes in operating conditions, Use of inhibitors, Anodic and Cathodic protection, Corrosion resistant coatings, Case studies.

CTL725 Recycling, Reusability and Remanufacturing

3 credits (3 0 0)

Physical components of batteries; sources of the battery materials; Recycling methods, current status of recycling both national and abroad, worldwide directives/policies for spent batteries, importance of recycling and its environmental impacts, mechanical recycling processes, grinding, washing, separating, drying, re-granulating and compounding, NMP-dissolving, ultrasonic treatment, alkaline-leaching, Second-life batteries, life-cycle assessment of battery recycling, redesign, reuse, and recycling, partial disassembly of the battery, removal of substandard cells, replacement of these cells, and reassembly of the battery

CTL727 Materials for Electric Vehicle Applications

3 credits (3 0 0)

Understanding the materials: Introduction, Classification of materials, Fundamentals of materials, Properties of Materials, Manufacturing methods for materials, Structure-property relationship, Materials of Steels and other metallic materials, Functionality of EV components:

Working principles of Motor and mechanical stresses, Working principles of Battery and thermomechanical stresses, Fundamentals of friction and wear, Working principles of Bearing and Friction materials, Failure aspect and Issues associated with EV components (Friction and wear, Corrosion, EMI/EMC, etc.). Requirements on EV materials: Materials selection strategies for Structural application, Motor, Battery, Brake, Bearing.

CTL729 Automotive Reliability and Life Testing

3 credits (3 0 0)

Fundamentals of Reliability, Availability and Maintainability, Failure distributions, Failure Analysis (FMEA, FTA etc.) Statistical analysis of failure data, parametric and Non parametric methods. System reliability assessment. Availability assessment. Maintainability and its assessment. Design for reliability and maintainability, Practical applications of RAM Engineering to Automotive. Reliability Testing, Accelerated Life Testing, Highly Accelerated Life Testing, Highly Accelerated Stress Screening, Recent Development in Life Testing. Importance of Life testing on Automobile components and sub components.

ITL730 Lubricants

3 Credits (2-0-2)

Overview of friction (F), wear (W) and lubrication, Primary role of lubricants in mitigation of F & W & heat transfer medium, Composition and properties of lubricant; Types of lubricants such as mineral oil based, synthetic lubricants, solid lubricants, and greases; Characteristics properties of lubes & greases; their evaluation methods, Classification systems such as API, SAE, AGMA, NLGI, ISO; Additives such as Viscosity-index improver (VII); Anti-oxidant (AO); Anti-friction (AF) Antiwear (AW) Extreme-pressure (EP); Corrosion inhibitors (CI), detergents, dispersants; Selection criteria for lubricants for various tribological situations and applications; Used lubes-environment & health hazards and disposibility and recycling, evaluation of oil degradation by various techniques.

CTL731 Automotive Noise and Condition Monitoring

3 credits (3 0 0)

Introduction to Noise, Vibration, Harshness, Noise measurement parameters, Standards and Techniques, Instrumentation for noise measurement and analysis, Noise Source Characterization and Control, Noise and Vibration control measures in Automobile, Sound Quality and Human Response. Maintenance strategies and requirement of condition monitoring in Automobile, Instrumentation of Condition Monitoring techniques and its application. Signal analysis, and classification of faults. Automotive elements health monitoring, Concept of Machine learning and IoT in condition monitoring of Automobile. Case Studies on Automobile Noise and Condition Monitoring.

CTL735 Computer Aided Analysis of Power Electronics

3 credits (3 0 0)

Driving cycles for EVs; Design driving factors; Vehicle System Modelling; Real time controllers: Compilers, linkers, debuggers, Interrupt based programming; Different PWM schemes and generation; Design and simulation of basic converter topologies, drivetrains; PWM switching and average converter model; Controller design and stability analysis; EMI/EMC design considerations in PCB design of power electronics; Thermal analysis for power electronic components; Failure analysis techniques: Introduction to Failure mode and effect analysis, Automotive industry safety standard (ISO 26262), Automotive electronics council, Problem solving techniques: Fault tree analysis techniques, A3 problem solving techniques.

ITL740 Risk Analysis and Safety

3 Credits (2-1-0)

Introduction, Typical hazards, Accident indices, Fire and explosion hazards, Dow's fire and explosion index, Hazards identification procedures for plants and machinery; Preliminary hazard analysis (PHA), Fault Hazard Analysis (FHA), Hazard and operability (HAZOP), What if, Check lists, Failure mode and effects analysis (FMEA), Failure mode, effects and criticality analysis (FMECA), HAZAN: Hazard analysis; FTA (Fault tree analysis), ETA (Event tree analysis), and CCA (Cause consequence analysis), Transportation of hazardous materials,

Safety audit, Health and safety aspects of lubricants, Human factors in safety, Risk evaluation and acceptance criteria, Disaster management, Safety codes and Case studies.

ITL752 Bulk Materials Handling

3 Credits (2-0-2)

Nature of bulk materials, Flow of gas-solids in pipelines, Mechanical Handling equipments like screw conveyors, belt conveyors and bucket elevators, Pneumatic conveying systems- Components, Design and Selection, Troubleshooting and Maintenance of pneumatic conveying systems, Performance evaluation of alternative systems, Bend erosion-influencing factors, materials selection and potential solutions, Case studies, and Design exercises.

ITL760 Noise Monitoring and Control

3 Credits (2-0-2)

Introduction to noise, Properties of noise, Loudness and weighting networks, Noise measurement parameters and standards, Impulse noise, Frequency analysis - octave, one third octave and FFT analysis, Instrumentation for noise measurement and analysis, Sound power, Sound intensity measurement technique with applications, Noise source location, Noise diagnostics, Noise monitoring of machines with examples, Estimation of machinery noise, Cepstrum analysis, Noise control methods, Maintenance and noise reduction, Road vehicle and aircraft noise sources and control, Case studies.

ITL810 Bearing Lubrication

3 Credits (3-0-0)

Introduction-Historical background, Bearing concepts and typical applications. Viscous flow concepts-Conservation of laws and its derivations: continuity, momentum (N-S equations) and energy, Solutions of Navier-Stokes equations. Order of magnitude analysis, General Reynolds equation-2D and 3D (Cartesian and Cylindrical), Various mechanisms of pressure development in an oil film, Performance parameters. Boundary Layer Concepts-Laminar and turbulent flow in bearings, mathematical modeling of flow in high-speed bearings. Elastic Deformation of bearing surfaces-Contact of smooth and rough solid surfaces, elasticity equation, Stress distribution and local deformation in mating surfaces due to loadings, methods to avoid singularity effects, Estimation of elastic deformation by numerical methods-Finite Difference Method (FDM), Governing equation for evaluation of film thickness in Elastohydrodynamic Lubrication (EHL) and its solution, Boundary conditions. Development of computer programs for mathematical modeling of flow in bearings, Numerical simulation of elastic deformation in bearing surfaces by FDM.

JID800 Minor Project

3 Credits (0-3-0)

The students will select a research topic for the minor project. It is expected that such topics would involve understanding of basic processes and applications.

JIS800 Independent Study

3 Credits (0-3-0)

This is meant only for such students who are selected for DAAD fellowship.

JID801 Major Project-Part-I

6 Credits (0-0-12)

The students will select a research topic for the major project. It is expected that such topics would involve understanding of basic processes and extensive experimentation.

CTD802 M. Tech Major Project Part II

12 credits (0 0 24)

Minor Project

3 credits (0 0 6)

JID802 Major Project-Part-II

12 Credits (0-0-24)

The research topic selected in Part-I shall continue in Part-II also.

Centre for Biomedical Engineering

BML330 Safety Principles for Engineers

3 Credit (3-0-0)

Pre-requisite(s): EC 60

Value theory-Risk and Reliability-Decision theory. Injury and damage control. Epidemiology of accidents. Human tolerance to energy inputs. Biomedical/biomechanical aspects of long term exposure to hazardous environment. Socio-technical aspects of safety standards. Case studies of well known disasters.

BML700 Introduction to Basic Medical Sciences for Engineers

3 Credit (3-0-0)

Anatomical and physiological study of different human systems. Cell and tissue organization and metabolism Cardiovascular System; hemodynamics, blood, conduction system in the heart. Soft and hard tissues and joints endocrine and nervous system and their role in homeostasis; Respiratory physiology; kidneys and the urinary system.

BMV700 Biomechanical Design of Medical Devices

1 Credit (1-0-0)

Introduction. Mechanics of cells and Tissues. Basics of Finite Element Modelling of tissues and organs. Design and Fabrication of Microfluidic devices. Design of diagnostic devices. Design of Endocrinal devices. Design of orthopaedic devices. Design of cardiovascular devices. Student presentations on innovative designs.

BMV701 Basic Electronics

1 Credits (1-0-0)

Fundamentals of Electronics, Electronics components and their principle of operation with respect to medical equipments. Operational Amplifiers and their use in biomedical instrumentation. Electronic interfacing of analog circuits with computer. LabVIEW based virtual instrumentation. Electronic signal conditioning.

BMV702 Basic Mathematics for Biologists

1 Credits (1-0-0)

Introduction to calculus, function, sets, Derivatives, integrals, exponentials and logarithm, complex numbers, sequence, series. Linear Algebra: Matrix, vector, basic operations on matrix, system of equations, linear and non linear equations. Differential Equations. Exposure to other topics like complex analysis, Fourier series.

BMV703 Basic biology & Physiology

1 Credits (1-0-0)

Basics of biology: Biomacromolecules, cells, biological membranes, Enzymes and enzyme catalysis, cellular metabolic pathways, cell cycle, cell division, molecular biology of cell, gene expression, DNA and its role in hereditary, cell signalling and communication. Microbiology - bacteria, fungi and prokaryotes, their cytological features and genetics. Human anatomy, organs and systems, hormones, nervous and sensory systems, nutrition, Innate and adaptive immunity.

BMV704 Mechanics of Biomaterials

1 Credits (1-0-0)

Forces and moments. Free body diagrams. Elastic, Plastic, Visco-elastic, visco-plastic. Bending, torsional and shear strength. Stress-strain relationships of linear and non-linear solids. Fatigue loading with and without corrosion. Fluid mechanics - Shear thinning and shear thickening fluids

BML710 Industrial Biomaterial Technology

3 Credits (3-0-0)

Good Manufacturing practice regulations, biomedical materials, quality assurance and quality control, Labeling, Device failure, synthetic and biopolymers, Bioerodible materials, Host reactions to biomaterials, Sterilization of Medical devices, Advances in Sterilization Technology of clean room, Polymeric materials for drug delivery systems, active and passive targeting, intelligent materials.

BML713 Pharmaceuticals, Efficacy and Delivery

3 Credits (3-0-0)

Pre-requisite(s): 75 earned credits (only for UG students)

Overlap with: BBL445, SBL706/709

Introduction to Pharmaceuticals, Overview of Pharmaceuticals Development, Uptake, Distribution, Pharmacokinetics, Pharmaceutical Transporters, its metabolism, and Toxicity, Case Studies: Antibiotic, Gastroesophageal Reflux Disease, Diabetic Medicine, Cancer Drugs, more drugs, modification of Pharmaceuticals, delivery of Pharmaceuticals.

BML720 Medical Imaging

3 Credits (3-0-0)

Overview of medical imaging modalities. Radiation physics. X-ray background, physics, principles, instrumentation, developments, applications. CT background, physics, principles, instrumentation, developments, applications. MRI background, physics, principles, instrumentation, developments, applications. Ultrasound background, physics, principles, instrumentation, developments, applications. Nuclear (SPECT, PET, Gamma) background, physics, principles, instrumentation, developments, applications. Optical Imaging background, physics, principles, instrumentation, developments, applications. Contrast enhanced imaging modalities - physics, latest developments, applications. Emerging imaging modalities (microwave, electrical impedance, etc.) - physics, latest developments, applications.

BML 735 Biomedical Signal and Image Processing

3 Credits (2-0-2)

Introduction to Biomedical Signal and Image data obtained using various techniques (ECG, FTIR, NMR spectroscopy, MRI, CT, nuclear imaging, ultrasound and optical imaging). Noise and error propagation in Biomedical Signal and Image data. Basic statistics for biomedical signal and image data analysis. Biomedical signal processing in time domain. Fourier and Laplace transform. Biomedical signal processing in frequency domain. Biomedical image processing, including segmentation, registration and pattern recognition. Mathematical models used in biomedical signal and image data analysis.

BML737 Application of Mathematics in Biomedical Engg.

2 Credit (2-0-0)

Mathematical functions commonly used in biomedical engineering; biomedical data, data analysis (Basic Biostatistics), data fitting; refreshing Engineering Mathematics; Applications of Mathematics in various areas of Biomedical Engineering (Biochemistry, Biomedical Signal and Imaging, Biosensors, Biomechanics, etc.), Mathematical modeling and simulations.

BML738 Biomedical Data Analysis

3 Credits (3-0-0)

Pre-requisite(s): 90 Credits for UG students. For PG students with mathematics till 10+2 level only, bridge course (BMV702) is compulsory.

Overlap with: BML800, BML735, MAL503/517/100, CHL761, MEL707, MTL108, MTL390, COL341/774, ELL409/784, SBL701, MSL892

Overview of biomedical data and its analysis. Basics of statistics in relation to biomedical data analysis. This will cover learning about data distributions, continuous and discrete data, data representation (histogram, box and whisker plot, etc.) normality test, descriptive statistics (mean, standard-deviation, mode, kurtosis, etc.), inferential statistics (t-test, F-test, etc.), receiver-operating-characteristic (ROC) curve analysis, correlations, etc. Pre-processing of data, qualitative, and quantitative analysis. Applications of mathematics in biomedical data analysis, including mathematical modeling, simulations, data fitting, and error analysis. Data compression and separation using SVD, PCA and ICA. Applications of Fourier transforms, Laplace transform, Basics of machine learning and its application in biomedical data analysis. Basics of machine learning: feature, normalization, training, validation and testing, data prediction, regression, data classification,

classifiers, logistic regression, support-vector-machine, random forest classifier, feature selection, and optimization of parameters of classifiers. Advanced machine learning approaches (neural network, deep learning, etc.) and their applications in biomedical data analysis.

BML740 Biomedical Instrumentation

3 Credits (3-0-0)

Generalized medical instrumentation systems and transducers-Digital Systems for biomedical instrumentation -Introduction to Microprocessor, Microcontroller, Digital Signal Processors, Introduction to Control systems- open loop and closed loop system, Transfer Function, P, PI, and PID Controllers. Genesis and recording of biosignals, ECG Instrumentation, Biomechanical measurements-kinematics, kinetics, anthropometry, Ear and Ophthalmological measurement - Ear Hearing loss, Sound conduction system, Basic and Pure tone audiometer, Evoked response audiometer, Vision - Tonometer, Ophthalmoscope, Perimeter, Blood related physical measurements - sound, flow, volume, and pressure. Clinical Laboratory Instrumentation - Introduction to electrochemistry, medical diagnosis with chemical test, Spectrophotometer, Colorimeter, Auto analyzers, clinical flame photometer, selective ion based electrodes, Pathology Instrumentation - Flow Cytometer, Haemocytometer, Haemoglobinometer, Anaesthesia Instrumentation - Need of anaesthesia, anaesthesia delivery system, breathing circuits. Ventilators, Diathermy, Introduction to instrumentation in X-Ray, MRI, CT scan, Introduction to MEMS. Electrical safety in medical environment - shock hazards, leakage current, safety codes, electrical safety analyzer, testing of biomedical equipments.

BML741 Medical Device Design

4 Credits (2-0-4)

Introduction to medical device design course and its significance in the current scenario; basic human physiology, communicable and non-communicable disease; different approaches to medical device design; considerations in medical device design; case studies of medical device design; identification of need, immersion, disease burden, disease state fundamentals, and the need for validation; development of concepts, ideation & brainstorming, evaluation of concepts, risk/benefit analysis; usability analysis & methods of prototyping; user feedback, stakeholder analysis & characterization; IP and regulatory requirements; conclusions.

BMD742 Minor Biodesign Project

4 Credits (0-0-8)

The course will cover activities pertaining to design-build-test-modify iterations in order to build functional prototypes of medical devices.

BML743 Special Topics In Biodesign

3 Credits (3-0-0)

The course contents will be flexible covering state of the art design, research and innovation issues pertaining to biodesign.

BMP743 Basic Biomedical Laboratory

2 Credits (0-0-4)

Students shall be introduced with practical training on basic electronic design and interfacing, and be given laboratory exercises on bioinstrumentation. Students will also be exposed to the role of medical imaging and signal processing in biomedical engineering. A few experiments training in materials synthesis, characterization and modification of various biomaterials will be given. Students will also get trained on sterile techniques of cell culture, cytotoxicity assays and cell staining techniques.

BML750 Point of Care Medical Diagnostic Devices

3 Credits (3-0-0)

Brief introductions to analytical chemistry and biochemistry; sensors and biosensors (immobilization, transducers, electronic components, op-amps and general circuits; data processing and presentation - LabVIEW based virtual instrumentation, etc.); Medical diagnostic techniques (biochemical, pathological, hematological analysis, DNA/RNA based analysis, etc.; Necessity for rapid and in-situ medical analysis; Point of care technology (POCT); Minaturization of

medical diagnostic devices – Microfabrication (materials, processes, techniques for detection); Microfluidics (concept, procedure, applications and challenges); Integrated microfluidic devices: Lab-on-a-chip, system-on-a-chip, micro-total analysis system (μ TAS); Present research scenario and future prospects; Case studies on POCT devices; Laboratory visit and demonstration of microfabrication processes and Lab-on-a-chip devices.

BML760 Biomedical Ethics, Safety and Regulatory Affairs

2 Credits (2-0-0)

Introduction to medical ethics and bioethics, environmental ethics. Use of animals in pre-clinical trials and ethical approval. Ethics issues in biomedical sciences (inhalable, injectable, implantable systems). Principles of biosafety. Biosafety cabinets, Laboratory biosafety levels. vertebrates and invertebrates safety levels, Biosafety of infectious agents: bacteria, fungus, parasite, prions, viruses, Biosafety of infectious agents: bacteria, fungus, parasite, prions, viruses. Laboratory security and emergency response, guidelines to work with infectious agents and toxins. Regulatory frameworks: FDA, BIS, ISO certification, CDSCO; health & family welfare laws and regulations on design, development, testing and production of biomedical products, including biologics, drugs, biotechnology-derived therapeutics, vaccines and medical devices. Clinical trials and current good manufacturing Practices. Basic introduction to IPR. Post-market issues and requirements.

BML770 Fundamentals of Biomechanics

3 Credits (3-0-0)

Overview and significance of biomechanics to lead a better life, challenges and opportunities, inventions/research. Orthopaedic components - bones, tendons, ligaments and cartilages -primary functions, material constituents (osteoclasts, osteoblasts, collagen, collagen fibrils), mechanical strength, building vs recuperation rate, force analysis. Cardiovascular components-arteries, veins, primary functions & flowrate, material constituents, mechanical strength, inflammation, life span vs. recuperation rate, force analysis. Biomaterials - Metals/alloys, polymers, ceramics, shape-memory alloys, composites and functionally graded materials. Basic Principles - Force-Motion, Force-Time, Inertia, Range of Motion, Segmental Interaction, Balance, Coordination continuum, Projection & Spin. Force analysis of Joints at various kinetic states - Spine (running, climbing, stairs, running downhill etc), Knee (squatting, jumping, climbing stairs, kickingsoccer), shoulder (abduction, adduction, bowling, smashing - racquet sports), Elbow (tennis, golf) and Hip (during fall, running). Demonstrations - Characterization, fractures & ruptures, non-invasive analysis (MRI, CT scan).

BML771 Orthopaedic Device Design

2 Credits (2-0-0)

Pre-requisite(s): AML732/AML835/AML851/MEL739

Introduction: a. Bones, tissues and muscles, b. Properties; Static and dynamic loads; Kinematics and Kinetics; Bone healing and remodelling; Strength, Wear and Corrosion; Design of Orthopaedic prostheses; Methods to avoid recurrence of fractures; Bone modelling; Guest lectures; Demonstrations.

BML772 Biofabrication

3 Credits (2-0-2)

Pre-requisite(s): 50 Credits

Introduction; bioprinting tissues, bones and cartilages; self-assembly, directed assembly, enzymatic assembly; laser-assisted bio-printing; fabrication of scaffolds (hydrogel method and fibre based); artificial bacteria (active/passive drug delivery, microswimmer); component fabrication (stereolithography, laser machining etc); mass production (stamping, micro-injection molding etc). Experiments: CAD (solidworks) and data import (from MRI/CT) - hands-on; Fused deposition molding (3D printing) - hands on; Fused deposition molding (3D printing) - hands on; Tissue & Organ printing (3D organ printer) - demonstration only; Scaffold generation - Hydrogel (Wet Chemistry) and Fibres (electrospinning) - hands on; Laser machining - hands on; Mask generation (E-beam lithography and focussed ion beam) -demonstration only; Characterization (Imaging, Profilometry,

optical scanner) - hands on; Stamping - hands on; Micro-injection molding - demonstration only.

BML781 Orthopedic Device Design and Prototyping

3 Credits (2-0-2)

Pre-requisite(s): 75 credits for UG students

1. Introduction: a. Bones, tissues and muscles, b. Properties; 2. Orthopedic requirements: a. Static and dynamic loads b. Kinematics and Kinetics c. Bone healing, wound healing and remodeling; 3. Strength, wear and corrosion of orthopedic devices a. Static strength b. Impact & fatigue strength c. Wear and d. Biochemical erosion and corrosion and e. biofilms; 4. Design of (a) orthopedic prosthesis for Wrist fracture, elbow arthroplasty, shoulder fracture, total hip replacement, spine fracture, femur fracture, total knee replacement, ligament arthroplasty, and tibia fractures (b) orthotics for foot abnormalities (c) methods to avoid re-occurrence of bone fracture and (d) modeling of bone; 5. Manufacturing techniques; 6. Regulatory requirements: Testing and certification; 7. Orthopedic devices case studies.

BML790 Modern Medicine: An Engineering Perspective

3 Credit (2-1-0)

The course will cover an overview of patho-physiology of some of the common non-communicable human diseases. Details of Cerebral Ischemia/Stroke, Diabetes and cardiac abnormalities will be discussed. With respect to each diseases the corresponding diagnostic techniques, tools, and physical principles of these instruments will be discussed. Students will be encouraged with lateral thinking and brain storming future engineering research potentials in improvement of current diagnostic and treatment modalities.

BML800 Research Techniques in Biomedical Engineering

3 Credits (3-0-0)

Simulation and analysis of physiological systems by up to date computer techniques and development of physical models; Biomechanical analysis and network representation; State of art bioinstrumentation techniques; monitoring physiological parameters electrical, mechanical and chemical parameters of human body, Microminiaturization of electronics including MEMS; BIOMEMS technology; Biomedical signal processing and imaging modalities; Research planning and interpretation of biomedical data; Telemedicine; Robotics in Medicine.

BMD801 Major Project-1

9 Credits (0-0-18)

The curriculum shall comprise of practical training on chosen research topic, optimization of experimental conditions, so as to take up independent research in major project.

BMD802 Major Project-2

12 Credits (0-0-24)

Students are expected to carry out research in biomedical engineering disciplines and preferably be able to publish or communicate their work at the end of project. A total of 18 credits including 12 from this curriculum shall enable them to submit M.Tech. Dissertation, which shall also be regarded as a publication.

BML810 Tissue Engineering

3 Credits (3-0-0)

The course will cover importance and scope of tissue engineering, Introduction to biomaterials and scaffolds, Criteria of modifying biomaterials as tissue engineering scaffolds, Properties and types of scaffolds, Different methods employed in the synthesis of scaffolds, animal cell biology, stem cells, organization of cells into tissues, tissue microenvironment, tissue injury and wound healing. Basic immunology, response of body to foreign materials. Animal cell culture on scaffolds, consequences, optimization strategies and important considerations for Skin, Liver, Bone, Cartilage, Nerve and Vascular tissue engineering.

BML815 Selected Topics in Biomedical Engineering

2 Credits (2-0-0)

Select current and emerging topics in biomedical engineering will be covered; details will be decided by the instructor.

BML820 Biomaterials

3 Credits (3-0-0)

Introduction to the use of implants. Structure and properties of materials used as implants : polymers, ceramics, metal and composites; biological response to implants, wound healing process, cellular response to foreign materials, criteria for selecting implants both for soft tissue and hard tissue, polymers used as vascular prosthesis, contact lens and reconstructive surgery materials.

BML830 Biosensor Technology

4 Credits (3-0-2)

Measurements and instrumentation principles. Fundamentals of transducers and sensors, their sensitivity, specificity, linearity and transduction system analysis. Introduction to biosensors; transduction principles used in biosensors viz. electrical, optical, microchip sensors and Surface acoustic wave devices and transducers and related technology. Biotechnological components of the sensor based on enzymes, antigen-antibody reaction, biochemical detection of analytes, organelles, whole cell, receptors, DNA probe, pesticide detection, sensors for pollutant gases. Kinetics, stability and reusability of sensors. Selected examples and future developments.

BMV840 Emerging Biomedical Technology & Health Care

1 Credit (1-0-0)

Importance of health related data collection and analysis, Epidemiological survey; brief them about various communicable & non-communicable diseases, path-physiological processes, environmental health and Life style diseases. Define the process of evolution of emerging technologies to solve the current health problems through an integrated approach of synergizing the discipline of medicine, engineering and management systems. Importance/ methodology of conducting clinical trials-human & animals.

BML850 Cancer: Diagnosis and Therapy

3 Credit (3-0-0)

Cancer and its classes; Hallmarks of cancer: Evasion of Apoptosis, Limitless replicative potential, Sustained Angiogenesis, Inflammation; Causes of Cancer: Carcinogens, oncogenes, mutations, viruses, dysregulation of cell cycle and the checkpoints; Tumor architecture, Importance of Hypoxia and angiogenesis in cancer; Tumor metabolism, Metastatic potential of cancer; Cancer Stem Cells and Biomarkers of Cancer; Diagnosis of cancer: Biopsy, Imaging, Endoscopy, Blood work; Therapy: Chemotherapy (small molecule, nanoparticle based), radiation, hyperthermia, immunotherapy, photodynamic, transplants and transfusions, targeted therapy, RNAi, non-invasive technologies; Resistance in Cancer; Scientific advances for understanding the origin, diagnosis and treatment of Cancer; Future prospects for cancer cure and diagnosis.

BML860 Nanomedicine

3 Credit (3-0-0)

Introduction to some basic nanoscience: quantum confinement and its effect; surface plasmon etc. Nanomaterial synthesis including bottom-up and top-down approaches. The significance of nano size, multiplexing and multilayering. Properties of nanoparticles and its dependence on shape, size, charge and aspect ratio. Interface of nanoparticles with biological systems (cells, viruses, bacteria, in vivo etc.) Techniques used for nanoparticle characterization before and after biological interface. Functional nanomaterials for biological and medical applications: Design criteria and synthetic protocols; Nanomaterials in tissue engineering, drug delivery, biosensors, hyperthermia, photodynamic therapy, etc. Modulating the specific biological response by nanostructures. Nanotoxicology.

BMV870 Vascular Bioengineering

1 Credit (1-0-0)

Embryology and formation of vascular networking in fetus and adult human body, autonomic nervous system influences, peculiarities of micro and macro vasculatures, the physiological fluid dynamic principles involved, the molecular level changes occurring in normal and abnormal conditions like atherosclerosis, cancers, utero-placental system and various imaging modalities.

National Resource Centre for Value Education in Engineering

VEL700 Human Values and Technology

3 Credits (2-1-0)

Present state of society-achievements and maladies. Notions of progress, development and human welfare. Distinction between 'pleasure' and 'happiness', 'good' and 'pleasant', 'needs' and 'wants'. Are there any universal human values? Complementarity of values and knowledge. Typical modern technologies- their impact on mankind. Fundamental characteristics of modern technology-their relationship to values. Sustainability of modern technology. Values for harmonious and sustainable development. Rationales behind universal human values. Values and humanistic psychology. Practical difficulties in living upto these values typical dilemmas. Need for inner transformation. Various approaches towards purification of mind. Concept of holistic development and holistic technology. Integrating scientific knowledge and human values, understanding engineering ethics.

VEL710 Traditional Knowledge Systems and Values

3 Credits (3-0-0)

The values inherent in The Traditional Knowledge Systems (TKS) viz., respect for all life and non-life, respect for diversity; awareness of social and ecological impact of activities; self-sufficiency; sustainability, socially appropriate, use of local natural and knowledge resources viz., decentralized, aesthetically pleasing, wealth distributive etc. It would be emphasized that these values are inherently present in the framework of traditional knowledge systems and are not add-ons. Traditional Technologies which are developed as part of the TKS framework are invented and tested in the field, where all environmental and social interaction, in particular its effect on other life-forms known and unknown are allowed to play their part. This non-fragmented approach makes such knowledge holistic and avoids the errors and pitfalls when technologies are applied on the basis of incomplete or inadequate theories.

VEV731 Special Module on Inner Development-I

1 Credit (0.5-0-1)

This module will primarily consist of courses which address one or more aspects of inner development such as comprehensive mindfulness, in-depth intellectual understanding of oneself and one's aspirations, selfless service etc. These courses are expected to provide a practical experience to the students in how small positive changes can be brought about in one's inner self through a systematic practice of looking within.

VEV732 Special Module on Inner Development-II

1 Credit (0.5-0-1)

(Same as VEV731).

VEV733 Special Module on Leadership-I

1 Credit (0.5-0-1)

This module will address the strong linkages between the personal values of an individual and the desirable qualities of a leader. Going beyond the theories, it will emphasize on the practical aspect of looking within as well as connecting to the outside world and hence developing the qualities of a leader.

VEV734 Special Module on Leadership-II

1 Credit (0.5-0-1)

(Same as VEV733).

VEV735 Special Module on Sustainability-I

1 Credit (0.5-0-1)

This module will consist of courses which address one or more aspects of sustainability vis-a-vis the societal value system. The three core components of sustainability, viz, sustainable use of resources, environmental protection and equity in the society need

to be understood in-depth with respect to the values of excessive materialism and individualism, competitiveness and unlimited economic growth on one hand and the values of compassion, fraternity and cooperation on the other. The practical sessions will be used to carry out group exercises of planning and analysis of real life case studies.

VEV736 Special Module on Sustainability-II

1 Credit (0.5-0-1)

(Same as VEV735).

VEV737 Special Module on Civilization-I

1 Credit (0.5-0-1)

This module will address one or more aspects of development of civilizations and promotion of societal peace which have strong linkages with the value system of the society. This could include value systems reflected in constitutions of different countries, the way a society deals with human rights and the like.

VEV738 Special Module on Civilization-II

1 Credit (0.5-0-1)

(Same as VEV737).

VEV739 Special Module on Professional Ethics-I

1 Credit (0.5-0-1)

This module will bring out the need for professional ethics as recognised by several professional bodies in the world through discussion of practical case studies and the underlying tenets of the code of conduct of professional bodies. The course will initiate discussion on reasons behind deviation from these tenets and the relevance of these tenets of professional ethics in the contemporary world.

VEV740 Special Module on Professional Ethics-II

1 Credit (0.5-0-1)

(Same as VEV739).

VEV741 Special Module on Inner Development-III

1 Credit (0.5-0-1)

VEV742 Introduction to Vocal Classical Music

1 Credit (0-0-2)

Pre-requisite(s): At least 50 earned credits for undergraduate students.

The course will start with the introduction to a classical concert. A top-down approach will be applied to identify the components in a concert, namely, different types of compositions and fundamental elements. The elements of a composition including the raag (melody), swar (notes), laya (rhythm), taal (meter) and lyrics will be discussed. This will be further dissected to identify the notes and movements involved in a melody. The role of spontaneity and creativity in music and how these are systematically developed will be discussed. The differences between south and north Indian forms of music will be discussed. Discussion on other aspects and genres of music such as folk, regional, and popular music will also form part of the course.

The course evaluation will be through both practical and written exams. Practical exam will be primarily listening based exams wherein their level understanding on various aspects such as raag, swar, laya, taal, lyrics, and different musical styles will be tested. Written exams will focus on the understanding of the fundamentals and theoretical aspects of music.

VED750 Minor Project

3 Credits (0-0-6)

To carry out detailed studies (under the guidance of a faculty member) on issues like Science, Technology and Human Values, Engineering Ethics, Sustainable Development, Scientific basis of human values etc.

Centre for Rural Development and Technology

RDL700 Biomass Production

3 Credits (3-0-0)

Introduction to biomass and biomass classification, Phytobiomass: Primary production-photosynthesis, measurement of productivity and statistical analysis of data. plant's nutrient cycles. Plant improvements-Tissue culture and other vegetative methods, seed technology and nursery raising. Biofertilizers., bioinoculants and biopesticides-Organic manures., nitrogen fixers, phosphorus solubilizers and organic matter decomposers, allelopathy, interactions among micro and macroflora and biological equilibrium. Plantations and cropping pattern agroforestry models, plantations crops, tuber crops, petro crops, forage crops and grasses. Soil and water conservation in farm, grassland and forest management. Aquatic Phytobiomass-Floating plants, submerged plants and potential aquatic algae biomass. Animal biomass: Cow, buffalo, goats, sheep and pigs. Fisheries and bee keeping.

RDL701 Rural Industrialisation: Policies, Programmes and Cases

3 Credits (3-0-0)

Background: Rural Industrialisation, India's rural poverty and possible solutions, Rural Industrialisation during planned era. Farm and Non-Farm Sector Synergy: Lessons from Asian experience, Rural Industrialisation in China: Township and village enterprises. Rural transformation through decentralized technologies, Sustainable Livelihoods: Participatory Management Approach, Appropriate strategy for Rural Industrialization, Policies for Rural Industrialisation Entrepreneurship, Development for Rural Youth, Women and appropriate Technology in Rural industrialization, Industrialization of rural areas around urban centres, Industrialization in tribal area, Role of Govt. and Financial Institutions in Rural Industrialization, Role and Impact of District industries Centres in Rural Industrialization, Gramodaya Scheme and rural industrialization, Development of Handloom Industry, Growth of production & employment in KVIS in India, Rural Industrialisation through Artisanal industry, Rural Industrialisation: Case Studies, Industrialisation of a drought-prone district: Grass root level planning, PURA Model of Rural Development, Some successful case Studies.

RDL702 Karigar & Traditional Industries

4 Credits (3-0-2)

Introduction to traditional Indian arts and industry. Classification of artisans based of skills, Geographical distribution of skills and relation to sustainable development method. Traditional Wood working and products, Leather working and products, ceramic working and products, Jewellery working and principles, Home furnishing, stone working and concept of home decor, Miscellaneous karigar and products.

RDL705 Rural Resources and Livelihoods

3 Credits (2-0-2)

Overview of different Livelihood Systems, Socio-economic, cultural and historic perspectives, Linkages between sustainable livelihood systems & development, Issues of subsistence and survival, challenges and threats, livelihood, Impact of globalization on livelihood systems, Formal and informal sector livelihood sources, Issue of Women, Agro-based/Post Harvest Technology based Livelihoods, Problems and challenges for agro-based small enterprises, Natural Resources based livelihoods, nature dependency, Scope, challenge for survival & enhancement of Natural Resource based livelihoods, Craft-based livelihoods, Challenge/Problems of traditional crafts, Need and strategy for preserving/revival of crafts and craftsmen, New product & service based livelihoods, SWOT for survival & growth, Sustainable Resource use and Livelihoods, Role of Continuing Education, Skill Development & EDP, Enterprise Management, SHGs, Cooperatives, Microenterprises Identifying entrepreneurial opportunities & mkt potential, Up scaling Microenterprises to SMEs – Issues & Perspectives, Importance and Scope of Training for Development, Goals for designing training programmes for development Self Development, Organisational development, Team Building, Skill Training, Technology Transfer etc., Types and Methods of training & learning, learning paradigms, Training :Strategy and Designs, Need Assessment Training: Planning, Methods

and interaction styles, Evaluation: Types, process, components, methods, techniques, Framework & indicators for evaluating Training Programmes Post Training factors, Tourism & Livelihoods, NTEP based livelihood.

Field projects related to Natural resource based livelihoods.

RDL710 Rural India and Planning for Development

3 Credits (3-0-0)

Historical and Geographical Aspects: Ancient and present structure of villages characteristics of rural life, zonal and regional peculiarities, social and religious stratifications.

Social Aspects: Influence of religion/tradition/superstitions, psychosocial and cultural background and practices, barriers, life patterns including community living, status of women, migration. General Aspects: Health education, nutrition, sanitation, housing, indebtedness, and bonded labour. Economic Aspects: General economic conditions, disparity, unemployment and wage pattern. Changes in techniques of production and requirements of storage, transportation and marketing facilities, private and public finance, rural banks. Postal and other services. Political Aspects: Village Panchayats and links of rural society with state's organisations; functions and role of various organisations. Planning for Rural Development: Historical perspective. Gandhian ideas and their impact; planning in independent India and emphasis on integrated rural development and attempts at rural reconstruction. Shift in development policies. Role of S&T voluntary, government and other agencies in rural development.

RDL722 Rural Energy Systems

3 Credits (2-0-2)

Biomass based energy systems, pyrolysis: concept, types, technology and waste management, gasification: concept, technology, design, operation and uses, biogas technology. Biogas production using various substrates including I1SW and industrial wastes, types of digesters and feed materials, biogas power generation, biogas enrichment and bottling technology, entrepreneurship avenues in biogas sector, biogas to natural gas* BBG technology, bio diesel: potential and scope in Indi.r, Bio-diesel production technology: uses and advantages. ethanol as alternate fuel, ethanol production Technologies, Uses and Advantages problems, Cook Stoves, Multifuel and biomass cook stoves, improved chulhas, micro hydel: Site characterization, Hydro potential estimation, Micro Turbines-Classification, design, sizing analyses, Hydel power utilities, Techno economic feasibility and social issues. Animal power; Application and power generation, Solar Energy Technologies, Solar Pond, Solar Photovoltaic, Concept of Hybrid energy system: Value proposition and benefits, creating renewable energy-based livelihood and micro enterprises Integrated Rural Energy Planning: Objectives, Technical options Benefits, Financial Incentives.

RDL724 Technologies for Water and Waste Management

3 Credits (2-0-2)

Water and wastes: General considerations, Role of water in life, Water crisis and causes, Concept of waste, Solid wastes and industrial effluents, Hazardous and toxic wastes, Natural cycles for zero waste systems, Eco sanitation, Water resources and management, Rainwater, runoff and ground water, Rainwater harvesting, Water storage and lifting devices, Processes for degrading waste, Role of microbes, earthworms, Anaerobic Digestion, Aerobic processes, hermo-chemical pathways, Water and waste in the domestic sector, Drinking water and non-potable uses, Domestic wastewater quality and recycling options, Domestic solid waste management, Micro enterprises for waste and water treatment, Agricultural systems, irrigation requirements and water audit. water conservation measures, Composting and its application, Water management in industries, Water requirement industries, Environmental regulations, wastewater treatment and recycling in rural industries.

RDL725 Ecological Perspective of Growth and Development

3 Credits (3-0-0)

The concepts of ecological studies, valuation of environmental

resources, their scarcities and optimal usage. Concept of Sustainability. Global environmental issues. Monetary assessment of environment: theories, policies and valuation methods. The growth and the environment: in search of the "optimal" scale of growth, Sustainable Development. Population, poverty and the environment.

RDL726 Herbal, Medicinal and Aromatic Products

3 Credits (2-0-2)

Herbal, Medicinal and Aromatic plants of India: Overview and Uses Ayurveda, Siddha, Homeopath, Unani and Tribal systems of Medicine, Role of Traditional 14edicine In Primary Health Care, Identification of Medicinal and Aromatic plants, Classification of Medicinal plants, Pharmacology and Phytochemistry, Medical Bio-prospecting and Chemo prospecting, Biomarkers, Active principle and Phytomedicine, Cultivation, Harvesting and Storage of 14edicinal and Aromatic plants: Organic farming of Medicinal and Aromatic Plants, Good Agriculture Practice, Post. Harvest Processing of Medicinal and Aromatic Plants, Cleaning and Washing, Drying, Grinding, Processing of Medicinal and Aromatic plants - Extraction, Purification of Active Principle/ Phytomedicine * Distillation, Herbal food formulation, Herbal cosmetics and cosmochemicals, Nutraceuticals, Mosquito control Products, Aromatherapy, Herbal Veterinary medicine, Natural Dyes and Colours, Quality Control and Analysis.

Practical and Project related to Herbal, Medicinal and Aromatic products.

RDL727 Conservation and Recycling Practice in Rural Areas

4 Credits (3-0-2)

Introduction to concept of conservation and sustainable growth. Traditional habits of rural Indian and other conservators. Effect of geographical parameters on local conservation practices. Conservation principles for water usage/ energy usage and usage of artificial chemicals and systems. Conservation principles for sustainable agriculture. Rainwater harvesting and Drip irrigation systems. Conservative practices for water usage. Usages of crop residues, Conservative food processing methods. Inclusion of health principles in food making. Conservative methods for rural housing and usage of land for construction. Development of conservative principles for rural planning. All these topics are taken from ancient Indian context.

RDL728 Rural Energy Assessment and Planning

3 Credits (3-0-0)

Overlap with: ESL751

Present energy sources; Energy conversion, trade and infrastructure; Energy inclusion and development; Energy access and policy; Rural Energy Database (REDB); Rural energy planning; Assessing local energy demand; Rural energy sources; Bioenergy resource assessment; Solar energy resources assessment; Wind energy resource assessment; Small hydro resource assessment; Geothermal and other resources.

RDL730 Technology Alternatives for Rural Development

3 Credits (3-0-0)

Concept of technologies appropriate for Rural India. Social, economic and environmental considerations. Appropriate technology for energy, agriculture, housing, textiles, water-supply and sanitation, health care, transport and small-scale industries. An integrated approach to the use of alternate technologies. Issues of technology transfer.

RDL735 Anaerobic Digestion and Biogas Energy Systems

3 Credits (3-0-0)

Biomass and biomass energy conversion processes. Fundamental of anaerobic digestion process and parametric requirements. Characteristics of biomass material for anaerobic digestion process. Biogas plant designing and matching of fuel application. Understanding fuel properties of biogas. Biogas purification processes and compression for storage. Utilization of biogas for thermal, power generation and vehicular applications. Energy and emission analysis.

Biogas digestate as bio-fertilizer for sustainable farming. Energy efficiency and economics of anaerobic digester for thermal, power generation and compressed biogas applications. Life cycle analysis (LCA) of anaerobic digester. Experiential learning of commercial scale biogas plant for power generation/compressed biogas production application.

RDL740 Technology for Utilization of Wastelands and Weeds

3 Credits (3-0-0)

Land as a parameter in rural development. Wastelands and importance of using them. Biomass growth on various types of lands, Introduction to plant taxonomy, underutilized terrestrial plants and aquatic weeds, flora of tropics, arid lands and hilly areas. Constituents of biomass, biochemical and chemical conversion processes. Applications of biomass as unconventional plant-based source for food, cattle feed, chemicals, fibres, construction materials and energy. An integrated technological approach to biomass and wasteland utilization. Possible ecological effects.

RDD750 Minor Project: Intensive Study on Topics of Specific Interest

3 Credits (0-0-6)

Project work related to any topics of interest within the specified time frame.

RDP750 Biomass Laboratory

3 Credits (0-0-6)

Soil and Water analysis for Biomass Production: Soil Sampling from a plot/field and soil analysis for its texture, pH. EC. C.N.P and K, Water analysis: TDS, Alkalinity, Total Hardness, EC and pH.

Soil Microflora and Root Association: Isolation and culturing of nitrogen fixers (Rhizobium, Azotobacter, Azospirillum and blue green algae). ecto and endomycorrhizal fungi, Measurement of total microbial biomass in soil and respiration rate of microbes. Bacterial and fungal root infection.

Biomass Production and Recycling: Microprilpaqation and other vegetative techniques for biomass production. Seed treatment and nursery raising. Vermiculturing and Vermicomposting, mushroom culturing and spawn production, silkworm rearing. Bioinoculants for rapid composting.

Compost Analysis: C. N. P. K. cellulose, hemicellulose, lignin, humus and its fractions. Physicochemical properties of biomass.

RDL760 Food Quality and Safety

3 Credits (3-0-0)

Concept of Holistic Health, Holistic Food, Food Quality & Safety. Food quality parameters and standards, (Natural and chemical preservatives & colours, toxins, pesticides, pathogens etc. Nutrients (macro and micro), shelf Life, seasonal food and diversity 'satvik' characteristics), Food processing industries-Current Status and Policy guidelines, Multi residue analysis and mycotoxin contamination in food. Processing techniques for enhancing bioavailability of micronutrients, Minimizing pesticide residue and mycotoxins in food products, Organic food: quality control and export potential, APEDA and IFOAM Certification 'BIS, MRL's under India conditions etc, Policy and regulatory safe guards, Food fortification and Nutraceuticals, Traditional as well as modern system, Botanical pesticides for stored grain protection, Major storage pests and their life cycle, traditional system and their limitations, Traditional systems and their limitations (storage structures, pest control measures etc.) Innovations, Village cluster Grain storage model for Rural Entrepreneurship, Enhancing shelf life of G-K products, grain flour, raw milk, fruits and vegetables, bamboo shoot mushroom etc., Equipment's & machinery for food processing and preservation small scale food outlets (vendors), SHG, WTP and quality control (case study).

RDL761 Value Chain in Agro-food Processing

3 Credits (2-0-2)

Importance and current status food processing and post-harvest management; techniques of post-harvest operations in agro-food

processing; packing and packing-house operations; science of agricultural crop drying and dehydration; food packaging techniques; packaging standards and regulations; various methods of food storage (bulk and bag storage), food grain storage structures; handling and transportation of agro produce; food preservation techniques; cold chain management; shelf life analysis; value addition; management of by-and waste products in agro-food processing; quality control techniques for agro-foods; food quality analysis methods; international agreements on sanitary and phyto-sanitary measures; HACCB GMP, ISO, CIP, FPO license, Codex standards, PFA standards; emerging trends in post-harvest technology and management; policy planning and legislations in food processing and management; supply chain management; open innovation and strategic alliance in agro-food processing; rural entrepreneurships and startups in agro-food processing.

RDL770 Rural Value Chain and Technologies for Holistic Development

3 Credits (2-0-2)

Comparison of unique anatomy of Indigenous cows and other ruminants. Introduction to Panchgavya and its significance in Indian perspective, comparison between different types of cattle. Panchgavya production and its application in past and present India. Importance of Panchgavya in food, medicine, agriculture rural economy, grassroot industrialization, environment, soil toxicity and pollution. Importance of Panchgavya in view of climate change: greener fuel, green farming, non-toxic soil, etc. Social and economic impacts of Panchgavya farming, biochemical and molecular understanding of different types of cattle milk products, critical control points of Panchgavya processing for different applications. Cost of technology development for Panchgavya products and adoption, developing low cost and small scale Panchgavya products, Planning, developing and sustaining Panchgavya based rural startups, risk assessment and management value chain development of Panchgavya products.

RDL801 Successful Grassroot Organisations

3 Credits (2-0-2)

The Domain and Challenges of Agricultural and Rural Development, Participatory Approaches to agricultural and Rural Development, Participatory approach in the irrigation sector, Learning process and assisted-Self-Reliance, Initiation & Leadership, CASE STUDIES-Set I, The AMUL Dairy Cooperatives, The Grameen Bank Story: Rural Credit in Bangladesh, CASE STUDIES - Set II SEWA: Women in movement, The Bangladesh Rural Advancement Committee, CASE STUDIES - Set III Participatory Watershed Development in Rajasthan, The self-

Help Rural Water Supply Program in Malawi, CAMPFIRE Program: Community- Based Wildlife Management, Management, Planning and Implementation, Technology and Training, Information as a Management Tool, Utilization of External Resources, Dealing with Government and Politics. Understanding Social Capital from experience of participation, Mapping & Measuring social Capital-Assessment of collective action, Understanding civil society as a continuum, Measuring empowerment at community & local level Analytical Issues, Strategies for strengthening organizations at the local level success & Sustainability i Strategic Goals for planning & Management.

RDL803 Informatics and Rural Development

3 Credits (2-0-2)

Introduction to ICT and Elements of ICT Trends in Computing & Telecommunication Technologies, User Devices, Transmission Technologies, Wireless Technologies, Emerging Trends and Convergence, ICT a Tool for Socio-Economic Development, Information Revolution and Information Society, Social informatics: ICT & RD, Impact of ICT for Development & Critique, ICT a Tool for Rural Empowerment, Techniques for Access to Technology, ICT in Agriculture, ICT for Rural Market, ICT in Dairy Mgmt, ICT & GIS, e-Government and Rural Development, What is e-Government and e-Governance, Trends in e-Government, Application of e-Gov for Service Delivery Access to Information, Grievance Redressal, Some Cases of e-Governance for RD, Implementation of ICT in Rural context, Software project management approach, Models of implementation, Rural Needs Assessment, People first approach to rural informatics, Citizen participation in Design of rural informatics, Role of Community based organisations, Challenges to rural informatics, digital divide, Gender and other marginalised groups in information society Issues in use of ICT for RD, Critical success factors for e-Gov in Rural Context, Global scenarios and national policies, international organization, regulatory interventions in computing and telecom industry Cyberlaws & IT act of India.

RDL807 Women, Technology and Development

3 Credits (2-0-2)

Role of women in development, Gender bias and indicators, Strategies for women empowerment, Technology and Women uplift, Women and energy, Women and water management, Women and health care, Women and holistic health, Women and Vector control, Women in farm sector, Women in non-farm sector, Women in the service sector; Women and information technology.

Field projects related to Women, Technology and Development.

Centre for Sensors, Instrumentation and Cyber-Physical Systems Engineering (formerly IDDC)

DSL601 Electronic Components and Circuits (for students other than Electrical/Electronics/Electronics and Communication)

3 Credits (3-0-0)

Review of Electronic Components: Passive Components, Active Components including components used in Industrial Environment. Electronic Circuits: Choppers, Clampers, analog circuits, precision and instrumentation amplifiers, signal conditioning circuits, industrial electronic circuits. Nonlinear devices and circuits, computing circuits and waveform generators. Analog-Digital circuits: A/D and D/A converters, classification and characteristic parameters of DAC's and ADC's. Testing criteria. Multiplying DAC's. Digital Electronics: Logic gates, Combinational logic design, Sequential logic design, Counters; Memory Devices, SRAM, DRAM, ROM, EPROM, Flash Memories and Programmable Gate Arrays. Microprocessors: 8 bit and 16 bit microprocessor, basic structure and programming. Application of microprocessors in instruments. Introduction to micro-controllers and embedded systems.

DSL603 Material and Mechanical Design (for students from Electrical/Electronics/Electronics and communication)

3 Credits (3-0-0)

Basics of Design: Stresses, strain, hardness, toughness, visco-elasticity, torsion, bending, deflection of beams, combined stresses, energy methods. Material: metals and their alloys, heat treatment, polymers, composites, ceramics etc. Design of machine elements: Failure theories for static and alternating loadings. Design of shafts, fasteners, springs, curved beams, thick and thin vessels, gears etc; Lubrication, journal bearings and rolling contact bearings, limits, fits and tolerances. Deflection of thin plates. Design of mechanical elements for strain gage and other instrumentation applications. Introduction to vibrations and its isolation. Mechanical Fabrication techniques used in instruments. Basic mechanical fabrication processes. Design and drawing sessions.

DSP703 Instrument Technology Laboratory 1

3 Credits (0-0-6)

The laboratory essentially supports the courses taught in the first semester courses. It consists of experiments on:-

Study of packaging and characterization of transducers used for measurement of different physical variables like displacement, temperature, pressure, strain, flow etc.; Study of practical signal conditioning techniques and electronic measurement methods; Study of Electronic subsystems used in instruments Experiments on Cardinal points measurements using Nodal slide method, Measurement of wedge angle of optical flat and right angle of a prism by Autocollimation, Measurement the long radius of curvature of concave mirror using Foucault Knife edge test and Ronchi test, Newton and Fizeau Interferometer for Testing of optical surface, Quantitative testing of optical elements using polarisation based Twyman-Green interferometer, Measurement of small radius of curvature of lens using "Optical Spherometer", Moire interferometry for displacement measurement.

DSP704 Instrument Technology Laboratory 2

3 Credits (0-0-6)

The laboratory supports the subjects taught in the second semester courses. The laboratory consists experiments on:

Study of various techniques used for analog and digital conditioning of signals from various transducers/ detectors; Study on modulation/demodulation techniques, noise generation and measurement, Study of testing and calibration methods of instruments. The structure of experiments has been designed to impart design level familiarity with various subsystems of instrumentation set up. The subsystems may consist of a detector-transducer, signal conditioner, a level power amplifier, display, actuator/final control element. The study will generally focus attention on one of the subsystems. In electronics conditioning. Specific Case Study Experiments as below:

- Experiments in Control involving speed, position, temperature controls using MATLAB

- Experiments in Heat Conduction/ Convection. And Heat Sink Characterisation
- Data conversion, ADC & DAC, synchronous detectors, multipliers, dividers, instrumentation amplifiers
- Microprocessor/Microcontroller based system design with emphasis on real world interfacing
- Experiments on precision measurement methods and metrology.

DSP705 Advanced Instrument Technology Lab

3 Credits (0-0-6)

Experiments on design, simulation and verification of instrumentation sub-systems addressing the following objectives:

the performance of practical transducer systems and their processing circuits dealing with other devices and circuit noise validation of algorithms for information extraction from sensor signatures dynamic range, threshold and sensitivity characterization and response time evaluation in practical environments.

Experiments based on Digital Signal Processing hardware and software to: Study of DSP architecture; Interfacing with peripheral components; Implementation of DSP algorithm; Experiments based on Talbot effect, Digital Speckle Pattern Interferometry and Shack Hartmann Sensor.

DSL711 Sensors and Transducers

3 Credits (3-0-0)

Transducer Fundamentals: Transducer terminology Design and performance characteristics, --- criteria for transducer selection, Case Studies – Transducers principles of representative cases with emphasis on special "Electronic Conditioning requirements" of different type of sensors-- Resistive transducer; Inductive transducers; capacitive transducers; piezoelectric transducer; semiconductor and other sensing structures. Displacement transducers; tachometers and velocity transducers; accelerometers and gyros; strain gauges; force and torque transducers; flow meters and level sensors; pressure transducers; sound and ultrasonic transducer. Phototubes and photodiodes; photovoltaic and photoconductive cells, photoemission, photo electromagnetic, detectors pressure actuated photoelectric detectors, design and operation of optical detectors, detector characteristics.

Brief Introduction -- Smart Intelligent Sensors, MEMS, Nano.

Transducer Performance: Static and dynamic performance parameters Standards: Electrical tests, measurement unit, measurement standards of of voltage, current, frequency, impedance etc .

Errors and noise: types of errors, Effect of noise and errors on resolution and threshold. Dynamic range.

Testing: Calibration, dynamic tests, environmental test, life test.

Case Studies in Application of transducers: displacement, velocity, acceleration, force, stress, strain, pressure and temperature measurement. Angular and linear encoders, Radar, laser and sonar distance measurement, Tachometers, Viscometer, densitometer.

DSL712 Electronic Techniques for Signal Conditioning and Interfacing

3 Credits (3-0-0)

Review of Network theory, transmission lines and Circuit parameters (Z Y Hybrid, etc) and introduction to HF Design and S parameters Analog signal conditioning, Ultra- precision conditioning, Gain; attenuation; input and output impedances; single ended and differential signals; CMRR; system-module interfacing consideration; measurement and characterization of electronic system modules. Analog and digital System Co-housing: EMI effects and EMC measures; circuit card placement; shielding and grounding techniques; ground loop management; isolation and interference filtering. EMI hardening and EMC interfacing. Analog and digital data transmission; modulation & demodulation; Data transmission; channel noise and noise immunity factors. Data busses; GPIB and other standards in parallel data transmission. Opto-electronic interfacing techniques. Analog and digital representation of data; comparisons and relative merits; multiplexing and demultiplexing of analog and digital data, ADC/DAC. Microcontroller and DSP applications. Application of CPU's in signal and data handling; response linearization and drift compensation; data logger, computer aided measurement and control.

DSL714 Instrument Design and Simulations**3 Credits (2-0-2)**

Review of circuit analysis and design. Review of signals and systems in time and frequency domain: Fourier and Laplace Transforms, response plots. Dynamic properties of instrument systems: Review of instrument control systems, on-off, proportional and PID controllers. Stability considerations, gain and phase margin. Use of pulse and harmonic test signals for performance evaluation. Linear modelling of instrument systems. Models for basic instrument building blocks. Simulation studies of circuit blocks. Simulation studies of circuits, instrument modules, transducers and control schemes using PSPICE and MATLAB expert simulation software.

DSS720 Independent Study**3 Credits (0-3-0)****DSL722 Precision Measurement Systems****3 Credits (3-0-0)**

Fundamentals of precision measurements: accuracy, precision, resolution, repeatability, reproducibility, consistency, drift analysis, dynamic range, Measurements and error estimation, systematic and random errors, Instrument transfer function, least square method and its applications, filtering, polynomial fitting, data analysis and statistical inference, correlation, Surface roughness, waviness and shape measurements, Study of some measurement systems such as mechanical and optical profilers, circularity, cylindricality and conicity measurement systems, Co-ordinate measuring machine, profile projector, long trace slope measuring profilometer, Shack-Hartmann sensor for slope measurement, Different Interferometers for optical metrology, absolute testing techniques, Moire techniques for measurements in industrial applications.

DSL731 Optical Components and Basic Instruments**3 Credits (3-0-0)**

Generation of light: Thermal, non-thermal and semiconductor light sources. Measurement of light and instrumentation, Properties and propagation of light; The Ray Optics, Wave Optics, and Electromagnetic Optics; Basics of interference, diffraction and polarization of light. Optical Components: Reflecting components, plane, Spherical, paraboloidal, total internal reflection. Refracting components; Converging, diverging and combination of lenses, Design analysis and image formation by lenses, Wavefront aberrations; Monochromatic (Seidel), and chromatic aberrations. Eyepieces: Huygens, Ramsden, and special eyepieces; Prisms, Polarizing prisms: Glan Taylor Polarizer, Glan-Thomson prism polarizer, Rochon Prism Polarizer, Senarmont prism polarizer, Wollaston Prism, Phase plates ($\lambda/2$, $\lambda/4$), Soleil – Babinet compensator, Diffracting components; diffraction by single/multiple/openings, types of gratings and fabrication techniques, diffractive optical elements. Polarizing components; Polarization by reflection, and double refraction, birefringence crystals, and polarization based optical devices, Rotatory Polarization, Polarization rotators; Optical instruments: Microscopes, Telescopes, cystoscope; Refracting, reflecting, interferometric telescopes. Interferometers; two-beam, multiple-beam, and shearing interferometers; Detectors: Photodetectors, CCD and CMOS detectors, IR-detectors.

DSL733 Optical Materials and Optical Techniques in Instrumentation**3 Credits (2-0-2)**

Optical materials: Optical and mechanical characteristics of optical glass, metal optics, plastic optics and optical crystals, Manufacturing of optics on optical glass and plastics, Injection molding of plastic optics, Single point diamond turning and CNC milling and micromachining, replication techniques. Photo-Lithography and its optical system, Illumination and projection systems, Astronomical and remote sensing systems, detectors: Thermal detectors, photon detectors and Imaging detectors.

DSL734 Laser Based Instrumentation**3 Credits (3-0-0)**

Radiation and matter interaction and fundamental of LASER action. The LASER and it's properties. Laser systems - gas and semiconductor LASERS. LASER beam optics and propagation of LASER beams.

Fundamentals of holography - basic theory of holography, recording medium and type of holograms for display purposes. Applications of holography in metrology - Holographic Interferometry, double exposure, time averaged and real time holographic interferometry. Laser speckles and laser speckles techniques. Digital speckle pattern interferometry (DSPI) and digital holographic interferometry (DHI) in measurements of displacement, refractive index, temperature, shape, vibration and material properties. Two wavelength and phase-shifting interferometry. Laser based temperature measurement techniques. Collimation testing and laser based alignment systems. Laser based techniques for low frequency and high frequency vibration measurements. Talbot interferometry and its applications in scientific and industrial measurements. Shearing interferometry and its applications in scientific and industrial measurements. Sensing of high currents on high voltage lines using magneto optic effect.

DSL737 Display Devices and Technology**3 Credits (3-0-0)**

Human vision. Basics of luminescence, fluorescence, and phosphorescence. Display materials and their characterization. Emissive displays: Review of cathode ray tube (CRT) displays. Plasma display devices and technologies, field-emissive, electro-chromic and photo-chromic displays. Inorganic, organic and polymeric LED based display devices: Device physics, materials, fabrication processes, structures, and drive circuits. Electro-optical characterization of LEDs. Transparent thin film (TFTs) displays, electronics, and manufacturing technologies and applications.

Non-emissive displays: basics of liquid-crystal materials, their properties and characterization. Liquid-crystal display devices and technologies. Transmissive, reflective, active and passive matrix, thin-film transistor (TFT), transreflective, and back lighting technologies for LCDs. Electronic-ink, electronic paper, and flexible and transparent display technologies and their applications. Laser based projection displays Display electronics and digital light processing technologies. Three-dimensional (3-D) imaging and display technologies: Micro-displays, STEREO SCOPIC 3D displays. HOLOGRAPHIC 3-D displays. Laser based 3D-TV.

DSL740 Instrument Organization and Ergonomics**3 Credits (2-0-2)**

Functions of instrument systems, classification of tasks as man-machine systems, need analysis, product specifications, solutions search, product planning, systems break-up. Strengths and weaknesses of the machines. Understanding the potentials and weaknesses of the human beings, application of force, load lifting, load carrying, stride patterns. Functions of controls and displays, handles, levers, knobs, switches, dials, LCD screens. Hand-held devices, workstations, large control systems. Identification of constraints emerging from scientific, technical, production, environmental and maintenance considerations. Aesthetics of color, form and graphics. Value engineering. Design of manuals, job-aids and training aids. Case studies, Exercises & Projects.

DSD801 Major Project Part-I**6 Credits (0-0-12)****DSD802 Major Project Part-I****12 Credits (0-0-24)****DSL811 Selected Topics in Instrumentation-I****3 Credits (3-0-0)**

Advanced course on Selected Topics in Instrumentation to the M.Tech. Instrument Technology Programme.

DSC812 Term Paper and Seminar**3 Credits (0-3-0)****DSL814 Selected Topics in Instrumentation-II****3 Credits (3-0-0)**

Advanced course on Selected Topics in Instrumentation to the M.Tech. Instrument Technology Programme.

DSL815 Special Topics in Instrumentation**1 Credit (1-0-0)**

Amar Nath and Shashi Khosla School of Information Technology

SIL761 Introduction to Information and Communication Technologies for Development

4 Credits (3-0-2)

This course will focus on the following topics: what is social development, introduction to social development initiatives, example of ICTs applied in social development, successes and failures, theories on ICTs leading to development, best practices, cases studies, and evaluation methods. A perspective throughout will be on things to keep in mind when building ICTs for development, than interpreting various initiatives.

SIL763 Introduction to Blockchains, Cryptocurrencies, and Smart Contracts

4 Credits (3-0-2)

This course will focus on the motivation for blockchains, cryptocurrencies, and smart contracts; ingredients of blockchains – P2P networking and cryptographic primitives; Bitcoin blockchain structure; blockchain consensus protocols; mining strategies and attacks; anonymity and traceability; scalability solutions – sharding, segregated witness, Lightning network; Ethereum, smart contracts and blockchain as a service; Emerging applications of blockchain.

SIL765 Networks & System Security

4 Credits (3-0-2)

The goal of this course is to introduce challenges in securing computer systems and networks. We will discuss various types of vulnerabilities in existing software interfaces, such as buffer overflows, unsafe libc functions, filesystem design issues, etc. We will also discuss modern-day defenses against attacks exploiting these vulnerabilities. In network security, we will discuss security problems in network protocols and routing, such as sniffing, denial of service, viruses, worms, etc. and defenses against them. The course will involve reading research papers on relevant topics, programming assignments, and projects.

SIL769 Internet Traffic -Measurement, Modeling & Analysis

4 Credits (3-0-2)

Internet architecture: overview of TCP/IP protocol stack. Mathematics for studying the Internet: Review of basic probability and statistics, analytic modeling approaches. Practical issues in Internet Measurements: Challenges, tools and techniques for measuring performance. Internet Traffic Characterization: Poisson models for Internet traffic, self-similarity in network traffic. Web Performance: workload characterization, caching, content distribution networks. Multimedia Systems: Video-on-Demand, IP-TV, Peer-to-Peer file sharing, Peer-to-Peer Streaming. Social Networks. Network Security.

SIL801 Special Topics in Multimedia System

3 Credits (3-0-0)

Content of this course, depending upon the teacher, will be focused on some aspect(s) of multimedia systems like content based retrieval, multimedia communication, compression techniques, speech and audio technology, etc.

SIL802 Special Topics in Web Based Computing

3 Credits (3-0-0)

Content of this course, depending upon the teacher, will be focused on some aspect(s) of web based computing like semantic web, web based distributed computing, search methods, etc.

SIV813 Applications of Computer in Medicines

1 Credit (1-0-0)

This course will consist of 14 lecture-hours that focus on information and communication technologies (ICT) that are being developed and used in medical education and clinical practice today. Various technologies ranging from computer aided instruction (CAI), simulations, and networked applications at one end to electronic medical records (EMR), telemedicine, and robotic surgery at the other end will be described. The process of research, development, and evaluation in the designing and making of these applications

and tools will be detailed. Writing assignments, creative thinking, and interactive discussions will form an integral part of this course.

SIV851 Special Module on eGovernance

1 Credit (1-0-0)

The contents will attempt to expose students with recent developments on different aspects of e-governance. Specific coverage will vary with each offering and may focus on some particular aspects of e-governance and related issues and accordingly may include appropriate project work and/or case studies as per the emphasis laid out in that offering.

SIL861 Special Topics in ICTD

3 Credits (3-0-0)

This course will focus on state-of-the-art and research problems of importance in ICTD area.

SIV861 Information and Comm Technologies for Development

1 Credit (1-0-0)

Notion of appropriate technology; case studies of ICTD projects such as KioskNet, WiLDNet (Wireless Long Distance Networks), AIR (Advanced Interactive Radio), Spoken Web, GRINS (Gramin Radio Inter Networking System), Digital Green; design principles to be kept in mind; evaluation methodologies.

SIV864 Special Module on Media Processing & Communication

1 Credit (1-0-0)

Communication today has rich multimedia contents. Under the varying bandwidth attention is required for appropriate processing of the media contents satisfying desired quality of service. This course will focus on bringing the two broad areas of multimedia processing and communication together. In media processing fundamental concepts of media processing and compression will be introduced with exposure to current techniques and standards. In communication protocols and algorithms for both wired and wireless networks will be discussed in relation to multimedia communication.

SIV871 Special Module in Computational Neuroscience

1 Credit (1-0-0)

Special module that focuses on research problems of importance in this area of Neuroscience from a computational perspective. Specific coverage will vary with each offering, and may include project work and design/case studies. Topics for each offering of the course will be separately listed.

SID880 Minor Project in Information Technology

3 Credits (0-0-6)

SIV889 Special Module in Human Computer Interface

1 Credit (1-0-0)

Special module that focuses on research problems of importance in this area from a computational and design perspective. Specific coverage will vary with each offering, and may include project work and design/case studies. Topics for each offering of the course will be separately listed.

SID890 Major Project (SIY)

36 Credits (0-0-72)

SIV895 Special Module on Intelligent Information Processing

1 Credit (1-0-0)

This course will focus on presenting conclave of methods which are being practiced for intelligent computing – learning techniques, classification methods, embedding intelligence, neural networks, soft computing and evolutionarily methods. Emphasis will also be given on the variety of multidisciplinary applications of such techniques.

Kusuma School of Biological Sciences

SBL100 Introductory Biology for Engineers

4 Credits (3-0-2)

Darwinian evolution & molecular perspective; Introduction to phylogeny - Classification systems in biology and relationships; Cellular assemblies – From single cell to multi-cellular organisms: Geometry, Structure and Energetics; Comparing natural vs. humanmade machines; Infection, disease and evolution – synergy and antagonism; Immunology – An example of permutations and combinations in biology; Cancer biology – Control and regulation; Stem cells – Degeneracy in biological systems; Engineering designs inspired by biology – Micro- to Macro- scales.

Laboratory: Biosafety; Buffers in biology - Measuring microlitres, Preparation of standard biological buffers, buffering capacity and pKa of buffers, response of cells and plant tissues in different buffering conditions; Observing cell surface and intracellular contents using light and fluorescence microscopy, measuring cellular motion using real-time video microscopy; Measuring and visualizing intracellular molecular components - Proteins and Genomic DNA

SBP200 Introduction to Practical Modern Biology

2 Credits (0-0-4)

Pre-requisite(s): SBL100

Biosafety lab practices – use of lab coats, gloves, safety goggles, eye wash, shower, chemical and biological waste disposal; Buffers in biology– Preparation of standard biological buffers, buffering capacity and pKa of buffers, biomolecules such as enzymes, whole cells and plant tissues in different buffering conditions; Observing cell surface and intracellular contents using light and fluorescence microscopy, "autofluorescence" of cells, real-time video microscopy of motile cells, cell growth and division; Plant genomic DNA isolation; Protoplast isolation and viability; Computer Modeling-From Genome Sequence to Protein Sequence and structure to screening for a "Hit" Molecule.

SBL201 High-Dimensional Biology

3 Credits (3-0-0)

Pre-requisite(s): SBL100

Introduction to Genomics, Proteomics, Metabolomics & Cellomics; Size vis-à-vis packaging and replication challenges; Biomolecular architecture and assemblies leading to function; Immortal cells and aging; Minimalist genomes & designer genomes; Molecular engines; Proteins as nanobiomachines; Network circuits for genome organization and protein-protein interactions, data hubs, party hubs, structure-function axioms; Biochemical cycles and feedback loops, Omics applications; Forensics; Drug targets.

SBD301 Mini Project

3 Credits (0-0-6)

Pre-requisite(s): SBL100 and EC 75

Systems Biology, Plant Molecular Biology, Bioprospecting, Tissue culture and Developmental Biology, Virology, Structural Biology, Cell Biophysics, Cellular Signalling, Protein folding and misfolding, Computational Biology.

SBL701 Biometry

3 Credits (3-0-0)

Pre-requisite(s): EC 75

Probability and Set theory: Application to biological data, Random variables: Individuals vs. populations in biological systems, Classification of data: "Discreteness or Continuity" in biological evolution, Distributions, Descriptive statistics, Inferential statistics, Analysis of variance (ANOVA), ANOVA-advanced concepts, Power analysis of variance, Regression and Correlation, Count/Frequency data. MATLAB based assignment activities will be designed for data simulation and analysis corresponding to the covered lecture material.

SBL702 Systems Biology

3 Credits (3-0-0)

Pre-requisite(s): EC 75

Overview and history of systems biology; Basic elements of molecular

biology – DNA and protein, the genetic code, transfer RNA and protein sequences and control of gene expression; Signal transduction – signaling pathways and cascades, information processing and transmission, pathway dynamics; Trees and sequences – graphs, connectivity, trees, flows in networks; Elements of process control – feedback, feed forward and cascade control, dynamics of closed loops, analogies with control of gene expression; Examples of transcription networks, determination of simple motifs that are repeated in genetics; guidelines for analyzing genetics circuits, layouts and representations, circuit dynamics; modeling, simulation and prediction of cellular events, micro-macro relations; Experimental methods in systems biology, creation of directed information, existing databases; platforms and applications; Case studies from literature – circadian clock, metabolic networks, gene circuit design; New frontiers.

SBL703 Advanced Cell Biology

3 Credits (3-0-0)

Pre-requisite(s): EC 75

Chemistry of biological structure, function and information flow, Cellular compartmentalization and molecular organization of organelles, Properties and growth of HeLa, Jurkat, SF9 etc.; De-novo synthesis of organelles versus templated replication, Microtubule, microfilament and intermediate filaments; Transport of biomolecules; Nuclear structure, chromatin packing and transport; Microtubule, action and filament based motile systems, cell-cell recognition and adhesion; Fluorescence, phase contrast, confocal and AFM; Molecular basis of cancer, oncogenes and tumor suppressor genes; cell growth and differentiation.

SBL704 Human Virology

3 Credits (3-0-0)

Pre-requisite(s): EC 75

Introduction, overview and history of medical Virology; Virus structure, classification and replication – symmetries, replication, maturation and release; Principles of viral pathogenesis- entry, cell tropism. Cellular pathogenesis, clearance and persistence; Respiratory viruses – Influenza, paramyxoviruses, adenoviruses, SARS, RSV; Viral gastroenteritis – causative agents, epidemiology; Hepatitis viruses – food borne and blood borne; Herpes viruses – infections in immunocompetent and immunocompromised individuals, latency; Enteroviruses – Polio, ECHO, coxsackie viruses; Congenital viral infections – effects on foetus, prevention; Retroviruses – HIV, AIDS; Arboviruses and Viral zoonoses – arthropod vectors, vertebrate hosts, transmission cycles, rabies and viral haemorrhagic fevers; Tumour viruses – oncogenic mechanisms of viruses; Strategies for control of viral infection – active and passive immunoprophylaxis, antiviral agents; Safety precautions – lab acquired infections, hazard groups and containment levels; Case studies from literature, evolving and emerging areas of interest.

SBL705 Biology of Proteins

3 Credits (3-0-0)

Pre-requisite(s): EC 75

Over-view of protein preparation, modification, maturation; protein-protein interactions in cells, Heat shock proteins and their structure and functions in cells, protein mimicry, assisted protein maturation processes in cells, Protein trafficking and dislocation, protein secretion from cell, kinetics and thermodynamics of protein folding and unfolding reactions, biomarker discovery, ribosome profiling.

SBL706 Biologics

3 Credits (3-0-0)

Pre-requisite(s): EC 75 and BEL110 or CYL110 or CYL120 or Equivalent

Definition and classification of biologics, Biologics, Biopharmaceuticals Vs. conventional drugs, Biosimilars, Role of rDNA technologies, transgenics (animal and plant), oligonucleotides, peptide, PNAs mediated therapeutics, drug delivery systems (lipids, cell penetrating peptides), vaccine, monoclonal antibodies produced by and in the

living organisms, nanobiopharmaceutics, overview of the technologies employed for identification, characterization and production of biologics, Bioprospecting for novel drug discovery and development, Gene prospecting, plant bioprospecting, marine bioprospecting Phytomedicines, plant secondary metabolites, herbal drugs, edible vaccines, Bioresource based alternative medicine systems - AYUSH, Southeast Asian medicine system, PIC, MAT and ABS, assessing the role of biomimetics, system biology, synthetic biology in biologic production, GMPs, legislations, Safety Regulations associated with biologics in biopharmaceuticals.

SBL707 Bacterial Pathogenesis

3 Credits (3-0-0)

Pre-requisite(s): EC 75 and BEL110 or CYL110 or CYL120 or Equivalent

Common features of bacterial pathogens, structural features, capsules and cell walls, Pathogenicity islands, types of toxins produced, effect of toxins on host cells, secretion systems, production and function of adhesions, attachment to host cells, mechanisms of cellular invasion, extracellular and intracellular invasion, intracellular survival and multiplication, virulence factors, mechanisms of antibiotic resistance, interaction with the host immune system- innate and adaptive, evasion strategies, Immunocompromised individuals and opportunistic pathogens, specific examples such as *Listeria*, *Mycobacterium*, *Shigella*, *Yersinia* etc., strategies for prevention and cure, drug designing and scope for future studies, emerging infectious bacterial pathogens.

SBL708 Epigenetics in Human Health and Disease

3 Credits (3-0-0)

Pre-requisite(s): EC 75 and BEL110 or CYL110 or CYL120 or Equivalent

Introduction – overview of epigenetics in human health and disease; Epigenetic mechanisms – basic mechanisms: DNA methylation and genome imprinting –role of DNA methylation; Epigenetics in cancer Biology – global and region specific changes and effects on transcription; DNA methylation and repeat instability diseases; Epigenetic reprogramming and role of DNA methylation in mammalian development –role in embryogenesis; Epigenetics in pluripotency and differentiation of embryonic stem cells; MicroRNA in carcinogenesis – mechanisms and potential therapeutic options; Epigenetic regulation of viruses by the host –role in pathogenesis; methods in epigenetics-methylation patterns and histone modifications; Case studies from literature, evolving and emerging areas of interest.

SBL709 Marine Bioprospecting

3 Credits (3-0-0)

Pre-requisite(s): EC 75 and BEL110 or CYL110 or CYL120 or Equivalent

Significance, Overview of Marine Bioresources, Marine Biomedical Research and Development; Drug discovery continuum in Marine Biotechnology, Omics, Biosensors, Biomaterials, Bionanotechnology, Bioactive compounds, Nutraceuticals, Pharmaceuticals, Cosmeceuticals, Novel Technologies in Marine Research, Sustainable development, Case studies, Emerging issues and challenges; IPRs, Marine Biodiversity and Traditional Knowledge (medicine).

SBL710 Chemical Biology

3 Credits (3-0-0)

Pre-requisite(s): EC 75 and BEL110 or CYL110 or CYL120 or Equivalent

Chemical modifications of proteins, protein and nucleic acid immobilization; The Organic Chemistry of Biological Pathways; cross linking in biomolecules; Physical Chemistry of proteins; fluorescent labeling of proteins and nucleic acids, sequencing of proteins and amino acids, radio labeling of proteins and nucleic acids, chemistry of glycosylation, phosphorylation, sulphonylation, methylation, of proteins and nucleic acids, non-ribosomal peptide synthesis, nano

particles mediated monitoring of protein conformational transition, folding and unfolding processes; surface properties of proteins and subsequent implications in cellular processes, solubility of proteins, physical basis for biomolecular structure formation, environmental effects on structure-function of biomolecules, chemistry of enzymatic digestion of nucleotides and proteins, role of metal ions in the cellular function, metallo-enzymes and their biosynthesis, Hydrogen/ Deuterium exchange reaction and its application in monitoring biological processes, basic concept of chemical synthesis of life.

SBL711 Cell Signalling

3 Credits (3-0-0)

Pre-requisite(s): SBL100 and SBL201 (or equivalent) and EC 75

Signaling as a basis of cellular communications, conversion of information into cellular response, first messenger, intracellular and extracellular receptors, second messenger, signaling proteins, signal amplification, cascade formation, adaptors, domains, scaffold, recruitment of signaling proteins, pseudosubstrates, convergence, divergence, cross talk, molecular switches, critical nodes, multisite protein phosphorylation, G-protein coupled signal transduction, nuclear receptors, growth factors and tyrosine kinases, mitogen activated protein kinases, insulin signal transduction, phosphatases, emerging technologies like antisense, omics, RNAi, high content screening, target hopping, combination of mutations, systems approach to understand signaling complexity.

SBL712 Dynamics of Infection Biology

3 Credits (3-0-0)

Pre-requisite(s): SBL100 and either SBL201 or BEL204 or BEL311 and EC 75

Features of bacterial/viral/other pathogens, molecular evolution and dissemination, factors influencing dissemination, host entry, receptors and pathways, host genetics, persistence and latency, co-infection dynamics, host-pathogen interactions, innate and adaptive immunity, Th1-Th2 balance, intracellular survival and dissemination, molecular mimicry, apoptosis and necrosis, intervention strategies and application of bioinformatics in infection biology.

SBL713 Introduction to Structural Biology

3 Credits (3-0-0)

Pre-requisite(s): SBL100 and either BEL204 or BEL311 and EC 75

Introduction to protein structure; secondary, tertiary and quaternary structures; expression and purification of recombinant proteins for structure determination; basics of X-ray crystallography, space groups, diffraction basics, phasing techniques, validation and Ramachandran plot; cryoelectron microscopy, freezing and imaging techniques, model building; small angle X-ray scattering (SAXS), application to protein samples; NMR, chemical shifts, common NMR experiments, assignment, validation; advantages and disadvantages of each technique, types of applications.

SBL714 Plant Biotechnology and Human Health

3 Credits (3-0-0)

Pre-requisite(s): EC 75

Overview of medicinal plants and their geographical distribution, economics of medicinal plants, KnapSACK family database, metabolic diversity, genomic and transcriptomic profiling, phenomics, antivenoms, plant toxins, bioactive peptides, genetic engineering and molecular biology technologies such as DNA barcoding, DNA chip technology, cDNA, AFLP, microarray, siRNA, antisense, bioanalytics, plant models systems, Nutrigenomics, smart and functional foods, Plants based human diseases communicable and noncommunicable diseases, synthetic biology approaches

SBL720 Genome and Healthcare

3 Credits (3-0-0)

Pre-requisite(s): As per IITD norms for 700 level courses EC

75 and BEL110 or CYL110 or CYL120 or Equivalent

Fundamentals of Chromosomes and Cells, Fundamentals of Gene Structure, Human Genome Organization, Principles Underlying human gene expression, Principles of Genetic Variation, Single Gene Disorders, Genetic Variation Producing Disease-causing Abnormalities in DNA and Chromosomes, Identifying Disease Genes and Genetic Susceptibility to Complex Disease, Genomic Medicine in healthcare, Genetic Approaches to Treating Disease, Cancer Genetics and Genomics, Human Genome Projects, Genetic Testing from Genes to Genomes and the ethics of Genetic Testing and Therapy.

SBL721 Techniques in Biomolecular Interactions

3 Credits (3-0-0)

Pre-requisite(s): As per IITD norms for 700 level courses EC 75 and BEL110 or CYL110 or CYL120 or Equivalent

Importance of Biomolecular Interactions, The Structure of DNA, Protein Structure and DNA Recognition, Protein-DNA Complexes, Electrophoretic Mobility, Footprinting, Analysis of Interactions by SELEX, Surface Plasmon Resonance, Biacore, Fluorescence Resonance Energy Transfer, Fluorescence Correlation Spectroscopy, Chromatin Immunoprecipitation, Nucleosome Mapping, Introduction to Protein-Protein Interaction, the use of SPR, ITC and fluorescence anisotropy in Studying Protein-Protein Interaction, Protein-protein interactions in human disease, Disruption of Protein-DNA Interactions: An Opportunity for Cancer Chemotherapy, Therapeutic Tools against Brain Damage.

SBL722 Stem Cells Biology

3 Credits (3-0-0)

Pre-requisite(s): EC 75 and BEL110 or CYL110 or CYL120 or Equivalent

Fundamentals of stem cells; Types of adult cells, embryonic, adult, pluripotent; Induced pluripotent stem cells, Genomic reprogramming; Stem cells in clinic and research, Use of stem cell for therapy; Application of stem cells in various disorders eg. Cardiovascular disease, Diabetes, Cancer, Parkinson's disease, Neurological disorders; Approaches for derivation and maintenance of human embryonic stem cells; Human cord blood-derived stem cells in transplantation and regenerative medicine; Stem cells for discovery of effective and safe new drug; Legal and intellectual property issues associated with stem cells; Stem cells perspectives: A vision of the future.

SBL723 Principles of Neural Excitability and Communication

3 Credits (3-0-0)

Pre-requisite(s): EC 75 and SBL 100/BBL 131/CML101/ Equivalent

Neural physiology overview; Elements of excitable cell membrane: ion channels, transporters and cytoskeletal elements; Physical principles of neuronal excitability: Diffusion, Electro-diffusion, Nernst-Planck Equation, Donnan equilibrium, Goldman-Hodgkin-Katz equation; Concept of Resting membrane potential (RMP), maintenance of RMP-Pumps and transporters; Exemplar pump: Na⁺-K⁺ ATPase-structure and function; Pores in the membrane: Ion channels; Hodgkin-Huxley model for Na⁺ and K⁺ channels; Action potentials; Ion channel structure, function & modulation; Synaptic transmission: vesicle transport and recycling, neurotransmitter release; Neurotransmitter-receptor structure-function; Methods to study ion channels and receptors: Patch-Clamp, planar-bilayer, crystallography and Cryo-EM studies; Action potential generation and conduction: Mechanism and models; Simulation of neural activity

SBL724 Decoding Protein Modifications in Biology

3 Credits (3-0-0)

Pre-requisite(s): EC 75 with SBL100 or Equivalent

Introduction to protein modifications – folded protein versus functional protein, residue modifications, proteolytic processing, transient versus stable modifications, co-translational versus posttranslational

modifications, domains decoding protein modifications; Protein phosphorylation – kinases and phosphatases, consequences of phosphorylation; Ubiquitination – ubiquitin proteasomal system, degradative and non-degradative ubiquitination, techniques in ubiquitination research; SUMOylation and other protein conjugation systems; Glycosylation –role in protein structure and function, advanced glycation intermediates, dynamic O-GlcNAc modifications; Other protein modifications – acetylation, methylation, lipidation etc.; Pathogen-induced host protein modifications; Generation of antibodies against protein modifications; In silico prediction of protein modifications; Protein modifications in diagnostics and therapy; Omics approaches for modified proteome; Kinase inhibitors as drugs.

SBL727 Advanced Developmental Biology

3 Credits 3-0-0)

Pre-requisite(s): EC 75 and SBL100 for UG students

Developmental Anatomy; Cellular identity, differentiation, and competence; Differential gene expression; Concept of model organisms; Signalling mechanisms controlling cell fate and patterning; Cell cycle and programmed cell death; Metabolic regulation of cell fate decisions; Current technologies to reprogram cellular identity and its implications for therapeutic applications; Genetic/developmental mechanisms of birth defects and human diseases; Regulation of cellular identity in cancer; Mechanisms of protein homeostasis in health, aging and disease, Maintenance, repair and replacement of diseased and damaged tissues; Microbiome in health and disease; Omics in Health and Disease.

SBL726 Biological Motors

3 Credits 3-0-0)

Pre-requisite(s): EC 75 and SBL100 for UG students

Introduction to molecular motors and biological motor proteins, historical perspectives, basics principles and broad functions; Polymerization motors: actin, tubulin and intermediary filaments-their structure-function, dynamics – from in-vivo and in-vitro studies and regulation; Force generators: Myosins, dyneins and Kinesin – their structure-function and regulation. Rotational motors – FoF1ATP synthase and bacterial flagella (structure and function). Eukaryotic Cilia/flagella; DNA helicase and polymerase; Viral assembly – with specific examples of bacteriophages and retroviruses; recent advance (research articles) on organelle transport; Nuclear motors; Molecular motors associated with disease – with emphasis on myosin, dynein and kinesin; Methodologies used to study biological motor proteins; Biological motors in futuristic design.

SBL725 Endocytosis and Intracellular Trafficking

3 Credits 3-0-0)

Pre-requisite(s): EC 75 and SBL100 for UG students

Introduction to endocytosis and intracellular trafficking – Structure, function and dynamics of Clathrin-mediated endocytosis; Clathrin-independent endocytosis; Receptor-mediated endocytosis; Traffic through endocytic and secretory pathway; Regulation of intracellular trafficking by vesicle fusion; Endosomal system and sorting; Biogenesis of endosomes and lysosomes; Functions of Rab GTPases in vesicle fusions; Role of SNAREs in phagosome maturation; Modulation of phagosome maturation by intracellular pathogens: Mycobacterium; Legionella; Salmonella etc.; Intracellular trafficking and antigen presentation; Human diseases due to defect in intracellular trafficking; Lysosomal storage disease, Atherosclerosis, Niemann Pick C Diseases, Cancers, Neurodegeneration; Exploiting endocytosis for nanomedicine.

SBL750 Quantitative Biology

3 Credits (3-0-0)

Pre-requisite(s): SBL100 and SBL201 (or equivalent) and EC 75

Overview of quantitative biology; Biomolecules - a study of how information is code in molecules - DNA, RNA and proteins, information representation; Molecular sequences - the alignment problem,

PAM and BLOSUM matrices, applications - global, local and overlap alignment; Gene prediction - computational gene finding, ab-initio methods, comparative methods; Molecular evolution - molecular clock, explicit models and evolutionary rate estimation; Population genetics - polymorphism, genetic diversity and Neutral theory; Testing evolutionary hypothesis; Genetic circuits - motifs search, satio-temporal logic, methods of analyses; Protein structure prediction, protein-protein interaction networks, drug target identification, Biological network dynamics; Biological pattern formation; Self organization in biology.

SBV750 Bioinspiration and Biomimetics

1 Credit (1-0-0)

Pre-requisite(s): EC 75

Introduction to Bioinspiration and biomimetics, Bioinspiration pools marine and terrestrial plants and animals, Biomimetic/Bioenabled materials, biomineralisation, Biomimetic adhesives and attachment devices in nature, prosthetics function and design, bioinspired robotics, biomimetic pattern formation, colour and camouflage, photocells, role in agriculture and human health, future prospects in the industry.

SBL751 Chemical and Molecular Foundations of Cell

3 Credits (3-0-0)

Pre-requisite(s): SBL100 and SBL201 (or equivalent) and EC 75

Protein conformation, dynamics and function, Enzyme activity, Biomolecular interactions in cell, biomolecular assemblies in the cell, Generation and storage of metabolic energy, Biosynthesis of macromolecular precursors like, amino acids, lipids, hormones, nucleotides, Characterisation and identification of cells, Genes, genomics and chromosomes, Genetic material, DNA replication, Repair, Translation, Mutagenesis, mutations and mutants, Plasmid and transposable element, Recombinant DNA and genetic engineering, Protein targeting into membranes and organelles, Vesicular traffic, secretion, and endocytosis, Cellular organization of movement, microtubules, Eukaryotic cell cycle, functions and mode of action of nucleus, Nerve cells, Immune response, Evolution of cells, prebiotic synthesis, RNA catalysis, evolution of gene structure, Epigenetics, Non-coding RNA, Hologenome.

SBC795 Graduate Student Research Seminar-I

0.5 Credit (0-0-1)

Pre-requisite(s): EC 75

The course is aimed at giving the student a forum to periodically present their research, to critique the research of colleagues and learn about the best research in their fields. Discussions will be held on scientific methodology and inculcated with a value system for pursuing a career in science. Activities will be carried out in workshop mode.

SBC796 Graduate Student Research Seminar-II

0.5 Credits (0-0-1)

Pre-requisite(s): EC 75

Special topics in research will be assigned by Coordinator; results of the research of each student registered for the course will be discussed; Discussions on scientific material from recently published papers in areas related to their research; The "Laboratory" activities will include delivery of seminars on their research and participation in the seminars and critique.

SBS800 Independent Study

3 Credits (0-3-0)

Pre-requisite(s): EC 100

The course is aimed at providing the student an opportunity to pursue a special research topic. A research topic assigned and mutually agreed upon by the faculty and student. Registration will require the submission of a proposal through the research committee on the topic clearly delineating the objectives to be achieved.

SBL801 Signal Transduction and Drug Target Identification

3 Credits (3-0-0)

Pre-requisite(s): EC 100

Eukaryotic cellular communications, importance of signal transduction, principles of signaling, recurring themes of signal transduction, reception, transduction, response, signal amplification, coordination of signaling, cascade formation, structure to function, anchors, adaptors, scaffold, recruitment of signaling proteins, topology and functional domains, dual specificity, modules, convergence, divergence, cross talk, receptors, G-protein coupled signal transduction, growth factors and tyrosine kinases, mitogen activated protein kinases, insulin signal transduction, critical nodes, protein phosphorylation, drug target identification, mechanism of drug action against signal transduction, antagonists of cell surface receptors and nuclear and receptors, ion channel blockers, transport inhibitors, targeting protein kinases and phosphatases, inhibitors of kinases and phosphatases, pseudosubstrates, examples of clinical drugs against protein kinases/phosphatases, new and emerging technologies to identify drug target like antisense, omics, RNAi, high content screening, target hopping, combination of mutations, systems approach, complexity in signaling, techniques in signal transduction.

SBL802 Macromolecular Structure and Data Processing

3 Credits (3-0-0)

Pre-requisite(s): EC 100

Treatment of macromolecules to generate suitable crystals, hanging drop and sitting drop techniques, seeding, cryoprotecting and freezing crystals, acquisition of diffraction data, synchrotron radiation, indexing and scaling data, space group identification, symmetry elements, Fourier transformation and structure factors, the phase problem, heavy atom methods, molecular replacement, anomalous X-ray scattering, calculation of electron density, model building and phase refinement, co-crystallography, small angle X-ray scattering, preparing samples for transmission electron microscopy, negative staining, cryo-techniques for freezing grids, manual vs. automated data collection, cryotomography, software packages for data collection and processing, generating a model, refinement and validation, time resolved cryoEM.

SBP810 Advanced Bioscience Techniques

2 Credits (0-0-4)

Pre-requisite(s): EC 75

Particle sizing, biological and biomolecular visualization tools, advanced and analytical spectrometry, cell and molecular separation techniques, DNA and protein interaction techniques, membrane interaction and signalling, bioreactors, tissue culture, transgene technology, electrophysiology methods.

SBV881 Advances in Chemical Biology

1 Credit (1-0-0)

Pre-requisite(s): EC 100

Structural aspects of proteins and nucleic acids, Mechanism of action of biological molecules, Chemical approaches to solve biological problems, Designing chemical tools for addressing problems in biology, Bioconjugate chemistry, Recent developments in these areas.

SBV882 Biological Membranes

1 Credit (1-0-0)

Pre-requisite(s): EC 100

Introduction to the hydrophobic effect, Phospholipid model systems, Cellular membrane asymmetry, Membrane dynamics, Membrane trafficking, Membrane fusion, Membrane proteins (Form and function), Small molecule permeability, Pores channels and transporters, Lipid systems for drug delivery.

SBV883 Chaperone and Protein Conformational Disorders

1 Credit (1-0-0)

Pre-requisite(s): EC 100

Molecular mechanism of protein misfolding, fate of aggregated proteins in the cell, various protein misfolding disorders in humans, mechanism of action of molecular chaperones in various cells, chaperone assisted suppression of protein misfolding.

SBV884 Elements of Neuroscience

1 Credit (1-0-0)

Pre-requisite(s): EC 100

Introduction to cell biology of neurons; presynaptic and post synaptic mechanisms; signal transduction cascades; neural integration; Hodgkin-Huxley experiments; Na and K pumps; physiological significance of pump modulation; Na and K channels; type and function of different Ca activated K channels; structure function and inactivation; tools for studying Ca signalling; caging and releasing Ca in the neurons; role of nitric oxide; Long term potentiation.

SBV885 Protein Aggregations and Diseases

1 Credit (1-0-0)

Pre-requisite(s): EC 100

Introduction to protein aggregation (amorphous and amyloid), types of aggregates, difference between aggregation and precipitation; External and internal factors for protein aggregation, pH, temperature and protein concentration effects; hydrophobicity, discordant helices; Structural and conformational prerequisites of amyloidogenesis, predominance of beta-sheet, alpha-helices or random coils of native protein; generic nature of protein folding and misfolding, Cytotoxic intermediates in the fibrillation pathway, Oxidative stress and protein deposition disease, Protein aggregation, ion channel formation, and membrane damage, Recent trends in prevention of amyloidosis; drugs, antibodies, combination therapy.

SBV886 Signaling Pathway Analysis

1 Credit (1-0-0)

Pre-requisite(s): EC 100

Introduction to modelling of biological systems – history, types of models, macroscopic phenomena, modelling of cellular systems; hierarchy in information transmission and utilization, interaction between different levels of information leading complex behaviour; robustness of cellular systems and its significance; molecules that transmit signals, role of signaling in regulation of cellular functions, gene regulation; signal transduction – evolution and history; first messengers and receptors, GTP-binding proteins; Calcium Signaling – free, bound and trapped calcium, mechanisms regulating calcium concentration, calcium changes in single cells; protein phosphorylation as a switch, protein kinase A, protein kinase C, structure of signaling pathways, extracting motifs from pathways, relating motifs to observations; dynamics and periodicity in signaling pathways.

SBV887 Current Topics in Computational Biology

1 Credit (1-0-0)

Pre-requisite(s): EC 100

Bring about awareness of the challenges in Genomics, Proteomics, Metabolomics and Structural Biology.

SBV888 Current Trends in Computer Aided Drug Discovery

1 Credit (1-0-0)

Pre-requisite(s): EC 100

Teach students various methods for target identification, and applications QSAR and molecular modelling in drug discovery.

SBV889 Diagnostic Virology

1 Credit (1-0-0)

Pre-requisite(s): EC 100

Introduction to diagnostic virology – direct and indirect methods, specimens and window period; Microscopy – light microscopy, electron microscopy, and fluorescence microscopy in virus identifications; Methods of virus isolation – cell culture, embryonated egg inoculation and animal inoculation; Viral antigen detection – methods, assay

characteristics, rapid antigen identification techniques; Detection of viral antibodies – methods, role of quantitative measurements, class-specific immunoglobulin detection; Viral nucleic acids – amplification, detection and quantitation methods; Molecular epidemiology of viral infections – high throughput methods; Identifying antiviral resistance – genotypic and phenotypic approaches; Quality control in diagnostic virology – internal and external quality control, international standards, and Shewhart control charts.

SBV890 Kinetoplastid Parasites and Novel Targets

1 Credit(1-0-0)

Pre-requisite(s): EC 100

Kinetoplastid diseases, transmission, clinical features, immune evasion, treatment, antimicrobial chemotherapy, drug resistance, cross – resistance, Leishmania, promastigotes and amastigotes, procyclic and metacyclic, macrophage, interaction with sand fly, cytokine response, transmission, syndromes associated with leishmaniasis, microtubules in kinetoplastida, dynamics and posttranslational modifications, drug interactions, resistance against tubulin binding agents, arsenite resistance in Leishmania, transporters in kinetoplastid protozoa and drug targets, leishmanial glucose transporters, function of histone deacetylases in kinetoplastid protozoa, DNA – topoisomerases in Leishmania, a possible therapeutic target, exoproteome of leishmania, importance and its application in Leishmania.

SBV891 – Virus Host Interactions

1 Credit (1-0-0)

Pre-requisite(s): EC 100

Introduction to the virus life cycle; host cell surface molecules utilized as virus receptors, mechanism of cellular membrane penetration for enveloped and non-enveloped animal viruses, cellular entry of bacteriophages and plant viruses; icosahedral and helical capsids, disassembly and transport of genome to the replication site, process of replication, modification of cellular organelles and hijacking of host cell resources; site and manner of progeny virus assembly ; lytic and lysogenic viruses; virus egress and involvement of the host secretory pathway; host defence mechanisms, virus strategies to evade host immune system, antiviral therapies and drug discovery.

SBV892 Current Topics in Ion Channels and Receptors

1 credit (1-0-0)

Pre-requisite(s): EC 75 with SBL 100/ BBL131

Overview of neuronal physiology; Ion channels and receptors of excitable cell membrane; Ion channel properties: Permeability, Selectivity, Gating and Rectification; Nernst-Planck and Goldman-Hodgkin-Katz equations; Classification of ion channels and receptors; Structure and function studies of ion channels and receptors: voltage-gated Na⁺ and K⁺ channels, ligand-gated acetylcholine receptor channel, mechano-gated mscL and Piezo channels; Allosteric modulation of ion channels: theories and application; Ion channel and receptor pharmacology; Methods to study ion channels and receptors: Patch-Clamp, planar-bilayer, crystallography and Cryo-EM studies; Simulation of single channel activity and macroscopic currents from kinetic modeling.

SBV893 Cellular Differentiation and Therapy

1 credit (1-0-0)

Pre-requisite(s): EC 75 with SBL100 or Equivalent

Introduction to differentiation including concepts of totipotency, pluripotency (stem cell), multipotency. Examples of the fertilized egg, somatic stem cells and plant callus will be included. Differentiation vis-a-vis cellular proliferation. Embryonic differentiation and the formation of the three germ layers. Fate specification by growth factors, concept of microenvironment and mechanotransduction in differentiation. Examples of the haematopoietic system. Nuclear signatures and differentiation. Cellular reprogramming–concepts and methodologies used including dedifferentiation - induced pluripotent stem cells (iPSC). Differentiation and its association with diseases such as Leukemia. How differentiation may be used in therapy. Differentiation in the large-scale production of specific cell types. Future perspectives.

SBV894 Current Methods in Mammalian Genetics

1 credit (1-0-0)

Pre-requisite(s): EC 75 and SBL100 or Equivalent

Introduction to mouse genetics – genotypes, genetic backgrounds and methods; Conventional methods of gene targeting and transgenics – gene delivery into embryonic stem cells or zygotes, gene-traps, breeding strategies; Establishment of cell culture models from mice – Fibroblasts and macrophage cultures, rescue strategies using retro/lentiviral transduction; Gene targeting in cells using CRISPR/Cas9 - mutations, activation and suppression; In vivo conditional knockout strategies using Cre/lox and Flippase/FRT system; Bone-marrow chimeras; Animal models of human diseases.

SBD895 MS Research Project

36 Credits (0-0-72)

The research problem will be assigned by the supervisor. It is expected that the student will undertake the problem early in the program.

SBV895 Developmental Biology

1 credit (1-0-0)

Pre-requisite(s): EC 75 with SBL100 or Equivalent

Overview of the principles of animal development: how a single-celled fertilised egg becomes an embryo and then a fully formed adult body; Understanding role of gene networks: how does the control of gene regulation contribute to development? Cell fate and differentiation: overview of the mechanisms of developmental commitment and maintenance of cell differentiation; Patterning: how are the axes formed? Organogenesis: how do developmental processes affect tissue homeostasis and restoration? Growth and post-embryonic development: aging and senescence; Regeneration: how can mechanisms of development be re-employed? Comparative development and evolution: how does comparison between species explain the emergence of new features? Experimental developmental biology: model organisms and the main techniques to study development.

Bharti School of Telecommunication Technology and Management

BSP710 Communication and Signal Processing Technologies Laboratory

3 Credits (0-1-4)

Pre-requisite(s): ELL205, ELL411

Signal processing tools – Keil for ARM processor, Code Composer Studio (CCS), Field Programme Gate Array (FGPA) processor; Pulse shaping and inter-symbol interference, digital filtering; design of ADC, DAC, PLL; receiver design; design of encoder and decoders: Convolution, Viterbi. Group-based term projects such as advanced coding schemes (LDPC, Turbo, RS, Polar, etc.) in conjunction with

Demapper using Soft-decision/Hard-decision principles building a complete end to end system: design of band-pass processors for cell phone application, sample implementation of OFDM waveform TX and RX – like Wifi-6 or LTE. Sample implementation of single carrier waveform (DVB-S2, Cable/QAM, Doesis) both for RX and TX, design of audio codec, design of rake receiver- all could be implemented on FPGA or DSP such as ARM processor.

BSD895 MS Research Project

36 Credits (0-0-72)

School of Public Policy

SPV399 Special Module in Policy Studies

1 Credit (1-0-0)

For the particular domain, topic or issue chosen by the instructor (e.g. climate change, energy, agriculture etc.) the course would aim to familiarized students with key concepts in science and technology policy making. It would include studying various elements, actors and stages in the policy process and critical perspectives on unpacking and understanding methods of policy analysis for the particular issue chosen by the instructor.

SPL701 Introduction to Science and Technology Policy Studies

1.5 Credits (1.5-0-0)

The course will begin with a brief theoretical understanding of policy making processes and touch upon the specifics of science and technology policy systems in India. It will specifically examine the role of stakeholders in the process such as grassroots voices and civil society organisations, industry, academia, international actors, and policy makers. It will then examine the role of science and technology in policies in selected current and emerging key sectors, e.g. transport, agriculture, health, energy, environment, or information and communication technologies. The course will also explore the inherently political and contested nature of decision making in the policy arena.

SPL702 Approaches to Science and Technology Policy Studies

1.5 Credits (1.5-0-0)

The course identifies six themes which are key to understanding Science and Technology Policy (STP) viz., Safety, Ownership, Ethics/morality, Knowledge base, Participation and Choice of policy instruments. Through sociological, economic, regulatory and legal literature on selected current and emerging key sectors, e.g. transport, agriculture, health, energy, environment, or information and communication technologies, it invites the students to keenly understand the various underlying approaches in STP.

SPL703 Research Methods for Public Policy

3 Credits (3-0-0)

Overlaps with: HUL709/814, HUV781, MSL709

Paradigms of research; Deductive vs Inductive approaches; Observational vs Experimental approaches; Formulating research questions and hypotheses; Approaches to review of literature; Identifying population of interests and units of analysis; Identifying relevant actors and stakeholders; Identifying system boundaries; Formulating a theory of change; Conceptualizing and operationalizing variables of interest; Survey design; Qualitative data collection: sample size determination, sampling techniques, modes of observation (case studies, focus groups, interviews); Quantitative data collection: sample size determination and sampling techniques, modes of observation (surveys, questionnaires, secondary data); Elementary qualitative data analysis; Elementary quantitative data analysis; Research Budgeting; Research Monitoring, External and Internal Validity; Dealing with attrition and missing values; Research ethics; Policy Communication.

SPL704 Introduction to Public Policy and STI

3 Credits (3-0-0)

Introduction to Public Policy; Disciplinary Evolution and History of Public Policy; Policy Instruments; Policy Narratives; Policy Cycle; Policy Design Vs. Policy Implementation; Governance; Global Perspectives on Public Policy; Theories, Frameworks, Models and Heuristics of Public Policy Introduction to Science & Technology Policy; Rational for Science-Policy Interface; Science-Policy Interactions; Governance of STI Enterprises; Science Policy and International Affairs.

SPL705 Public Institutions in India: Theory and Practice

3 Credits (3-0-0)

Executive, Legislative, Judicial Branches and Balance of Powers; Political Parties and Election Commission; Planning Commission and Niti Aayog; Bureaucracies and Public Choice Theory; IRS and Taxation, GST; Police and Law Enforcement; CAG, CVC, CIC and Institutions of Accountability; Banking System and RBI; The Value of Institutional Independence; The Regulatory State; Federal Institutions: Finance Commission, GST Council, Ministerial Forums etc.; Decentralisation and 73rd and 74th Amendments; The Role of Civil Society; Redistributive Institutions (PDS, MGNREGA, DBT); Introduction to Case Study Methodology, Studying Organizations, Systems and Processes; Interplay between public institutions and how they influence, affect and change each other.

SPL706 Science, Technology, Innovation and Sustainable Development

3 Credits (3-0-0)

Sustainable development and the SDGs; Historical perspective on processes of technology development to meet societal objectives; nature and dynamics of technological change; elements of innovation processes and perspectives on organizing for effective innovation (and role of key actors); case studies on role of STI in agriculture, health, energy, and environment; potential future role of STI in SD in India.

SPL707 Tools for Policy Analysis

3 Credits (3-0-0)

Introduction to the policy process; Role of policy analyst; Stakeholder analysis; Graphical methods for visualizing data; Cost-Benefit Analysis; Experiments and quasi-experiments; Projection Techniques; Delphi Technique; Decision-trees; Multi-criteria Decision Analysis (MCDA); Expert elicitation.

SPL708 Statistics for Public Policy

3 Credits (3-0-0)

Overlaps with: MSL721, HUL315/HUL719

Probability and statistics Basics (Random variables, Population and sample, Parameters and Estimates, Normal distribution, Sampling distributions of estimates, Confidence intervals); Hypothesis testing (z-test, t-tests, chi square tests, p-values, comparison of means tests); Bivariate linear regression model; Multivariate regression model (Gauss Markov Theorem, Inference and Prediction, ANOVA); Model Specification Errors (Omitted Variables, Irrelevant Variables); Dealing with real-world issues (Multicollinearity, Heteroskedasticity, Outliers); Categorical variables in linear regression (Dummy Variables, Logit/Probit models); Introduction to Time Series Analysis; Introduction to Panel Data Analysis; Correlation vs Causation.

SPL709 Principles of Economics for Public Policy

3 Credits (3-0-0)

Introduction to Economics; Supply, demand and markets; Theories of consumer demand and cost; Welfare economics and deadweight loss; Market failures and government policies; Market structure; Taxation and National accounting; Productivity and growth; Saving and investment; Unemployment; the Monetary System; International trade; Monetary and Fiscal Policy.

SPL711 Modelling Complex Adaptive Systems for Policy Analysis

3 Credits (3-0-0)

Definitions of system thinking; complexity, adaptation; and socio-technical systems; Understanding complex adaptive systems; and the properties that characterize it; Put in perspective commonly applied modelling approaches in policy analysis with the framework of complex adaptive systems; A framework for modelling complex adaptive systems; agent based modelling; Practice-oriented steps to building an agent-based model for a policy problem of your choice –problem formulation, concept formulation, model formulations, verification and validation.

SPL712 Comparative Industrial Policy

3 Credits (3-0-0)

Overlaps with: HUL736

Comparative Industrial Policy, Political Economy of Economic Development, Primary vs. Secondary vs. Tertiary Production and Policy Environments Supporting Each, Infant Industry Argument, Import Substituting Industrialization and Autarky, Dependency Theory, Market Protection vs. Market Integration, East Asian Model vs. Other Developing Countries, Causes and Consequences of Industrial Concentration, Growth Diagnostics and Building Comparative Advantage, Industrial Clusters and SEZs, Market vs. State-Led Growth, Cooperative and Market-Preserving Federalism; Institutional Form and State Capacity.

SPL720 Energy and Infrastructure Finance: A Public Policy Lens

3 Credits (3-0-0)

The role of finance in creating energy and infrastructure assets; Basics of DCF Method and Valuation; Applying DCF to Infrastructure Investment; Difficulties of Raising Long-Term Finance; Project Finance; Role of Govts in Facilitating Infra Investment; State vs. Private Financing; Debt vs Equity, Risk Capital; The Role of the Promoter and Risk-Taking; Stages of Exit for Infra Projects; Public Private Partnerships: The Promise and the Reality; Hedging and Price Risk; Infrastructure Booms and Busts; Bank Financing vs. Project Financing through Bonds; DFIs, NBFCs and Risk Assessment; Currency markets and infrastructure finance, bilateral aid and EXIM banks; Tenders, bidding and contracts; Arbitration, renegotiation and the costs of extended dispute resolution; The effects of infrastructure on public finances; National vs. Local Infrastructure; Controllable vs. Uncontrollable Risks, Cash flow Management.

SPL721 Perspectives on Climate Change: Implications for Policy

3 Credits (3-0-0)

The course will develop a basic understanding of science of climate change, the associated uncertainties and the processes that link this science with policymaking. The impacts of climate change on socio-economic and natural systems and the link between climate change, and development policies will be discussed. The global distribution of greenhouse gas emissions and possible technological, market and regulatory trajectories to mitigate them will be discussed with the emphasis on how different trajectories lead to questions on geographic, inter-generational and distributional equity. The students would examine economic, political and institutional frameworks for understanding policies and practices designed to reduce greenhouse gas emissions, vulnerability to climate change and facilitate adaptation in the face of climate threats and explore how policy can produce or reduce vulnerability. The course will draw on theoretical framings and methodological tools from multiple disciplines including atmospheric sciences, economics, environmental policy, psychology and sociology.

SPL722 Managing the Energy Transition

3 Credits (3-0-0)

Introduction to the global energy transition; Features of historical technological transitions; Systemic and evolutionary views on technological change; Introduction to policy studies in the context of technological transitions; Domestic and international politics of energy transitions and climate change; Firm strategies under uncertainty and change; the role of finance.

SPL730 STI Policy and Agriculture

3 Credits (3-0-0)

Introduction to Agriculture, Development and Food Security; STI contribution to Agricultural Development; Types of Agriculture; Formal Institutions and Organization of Agricultural Research and Policy Making; ToT; Agro Ecology; Linear to Systems thinking in Agri-Systems; Agricultural Knowledge and Information Systems; Farmer's Field School, Farmer First Movement; Agricultural Innovation Systems (AIS); Agricultural Research for Development (AR4D); Mission Oriented Agricultural Innovation Systems (MAIS); Institutional Change in Agriculture; Science of Scaling; Smallholder agriculture; Global Food Security and Global Agri-Food Systems; Water, Energy and Food Security Nexus; Sustainable Agriculture; New Institutions for Global Agriculture; Agriculture 4.0.

SPL740 Causal Inference and Impact Assessment

3 Credits (3-0-0)

Introduction to Impact Assessment; Causality and the Problem of Confounders; Counterfactuals; Experimental design in social sciences: Randomized Control Trials or RCTs; Implementation failures within the RCT framework: Non-Compliance, Attrition, Interference; Critique of RCTs; Instrumental Variables; Matching Estimators; Propensity Score Methods; Difference in Difference Methods; Regression Discontinuity Design; Synthetic Control Methods; Structural Causal Models; Causal Forests; List Experiments and Natural Experiments; Qualitative Methods for Causal Inference.

SPL741 Socio-Economic Data Analysis

3 Credits (3-0-0)

Data analysis basics; Challenges of dealing with real-world socio-economic survey data; Introduction to R programming; Overview of nationally representative data sources in India; Background, Review of important papers, Public Policy lessons and Hands-on data analysis. The following datasets will be used: 1) Indian Census, 2) Demographics datasets like National Sample Surveys and India Human Development Surveys, 3) Health and Nutrition datasets like National Health Surveys and District Level Household Surveys, 4) Education datasets like Annual Status of Education Report, 5) Agriculture datasets like ICRISAT Village Dynamics in South Asia, 6) Manufacturing datasets like Annual Survey of Industries.

SPV799 Special Module is Policy Studies

1 Credit (1-0-0)

For the particular domain, topic or issue chosen by the instructor (e.g. climate change, energy, agriculture etc.) the course would aim to familiarized students with key concepts in science and technology policy making. It would include studying various elements, actors and stages in the policy process and critical perspectives on unpacking and understanding methods of policy analysis for the particular issue chosen by the instructor.

SPL810 Selected Topics in Policy Studies

3 Credits (3-0-0)

This course will introduce students to advanced topics in Policy Studies as decided by the instructor.

SPD881 MPP Major Project – I

4 Credits (0-0-8)

Each Master's research thesis would be unique and contents would be developed by the student under the supervision of advisor(s). A research committee consisting of supervisor, internal examiner, an external expert and chairman would evaluate the thesis.

SPD882 MPP Major Project – II

14 Credits (0-0-28)

Each Master's research thesis would be unique and contents would be developed by the student under the supervision of advisor(s). A research committee consisting of supervisor, internal examiner, an external expert and chairman would evaluate the thesis.

Interdisciplinary M.Tech. Programmes

M.Tech. Programme in Optoelectronics and Optical Communications

JOP791 Laboratory-I (Fiber Optics and Opt. Comm. Lab)
3 Credits (0-0-6)

JOP792 Laboratory-II (Fiber Optics and Opt. Comm. Lab)
3 Credits (0-0-6)

JOL793 Selected Topics-I
3 Credits (3-0-0)

JOL794 Selected Topics-II
3 Credits (3-0-0)

JOS795 Independent Study
3 Credits (0-3-0)

JOV796 Selected Topics in Photonics
1 Credit (1-0-0)

JOD801 Major Project Part-I
6 Credits (0-0-12)

JOD802 Major Project Part-II
12 Credits (0-0-24)

M.Tech. Programme in Cyber Security

JCD891 Minor Project
3 Credits (0-0-6)

Research and development oriented projects based on problems of practical and theoretical interest. Evaluation will be done based on periodic presentations, student seminars, written reports, and evaluation of the developed system (if applicable).

JCD892 M.Tech. Project Part-I
6 Credits (0-0-12)

The student will work on a challenging problem of practical or theoretical interest in the area of computer security. He or she will design a prototype system or create a theoretical basis for his/her chosen problem.

JCD893 M.Tech. Project Part-II
12 Credits (0-0-24)

The student will complete the M.Tech Part-I project, and either develop a fully functional prototype or propose concrete theoretical results in the area of computer security.

JCS816 Independent Study
3 Credits (0-3-0)

The student will be tasked with certain reading assignments and related problem solving in an appropriate area of research in Cyber Security under the overall guidance of a faculty member. Prior to registration, a detailed plan of work should be submitted by the student to the Head of the Centre for approval.

SIL618 Computer Architecture
4 Credits (3-0-2)

Overlaps with: COL216 (100%), ELL305(50%)

Prerequisite(s) : ELL201 or equivalent

History of computers, Boolean logic and number systems, Assembly language programming, ARM assembly language, Computer arithmetic, Design of a basic processor, Microprogramming, Pipelining, Memory system, Virtual memory, I/O protocols and devices, Multiprocessors.

SIL771 Special Topics in Cyber Security
3 Credits (3-0-0)

Prerequisite(s) : COL334 Computer Network

Cybersecurity Standards & Compliance, Applied Network Security, Application Security, Software Security, Cybersecurity Risk Management & Compliance, Mobile Device Management, Secure Unix Administration, Introduction to Reverse Engineering, Insider Threats, Introduction to Digital Forensics.

SIV810 Special Module in Cyber Security
1.5 Credits (1-0-1)

Potential topics or themes which may be covered (one topic per

offering) include: Cybersecurity Standards & Compliance, Applied Network Security, Cyber Physical Systems security, Application Security, Cloud Computing security, Software Security, Cybersecurity Risk Management, Distributed systems design, Intrusion Detection Systems, Cryptography

SIV814 Special Module in Application Security
1.5 Credits (1-0-1)

Overview of Web Applications, Introduction to Web Application Security, Web Application vulnerabilities, OWASP Top 10, Security Scanners & Interpreting Scan Reports, Protecting, Improving and some guidelines for Web Application Security.

SIV812 Special Module in Computer Forensics
1.5 Credits (1-0-1)

Introduction to Computer Forensics, Overview of hardware and operating systems, Data recovery, Computer Forensic, Network Forensic, Mobile Network Forensic, Software Reverse Engineering, Computer crime and Legal issues.

SIL775 Biometric Security
3 Credits (3-0-0)

Prerequisite(s) : COL106/COL702

Overview of Biometrics, benefits of biometrics over traditional authentication systems, Biometric parameters, biometric matching methods and accuracy in biometric systems, Overview of Image Processing for Biometric Applications, Biometric system design challenges, Biometric recognition: Fingerprint, Face, Iris, Voice, signature (offline and online), Multi-modal Biometric recognition Systems, Challenges to maintain cryptographic key, Biometrics security of cryptographic keys.

Template Protection, Fuzzy Vault and its weaknesses and secure template management.

SIL773 Digital Watermarking and Steganography
3 Credits (3-0-0)

Prerequisite(s) : COL106 Data Structures and Algorithms/ COL702 Advanced Data Structures

Introduction to Information Hiding, Steganography and Watermarking, Digital Watermarking: Applications, techniques, models, watermarking detection techniques. Visible and invisible watermarks. Watermark security, digital watermark attacks, Steganography techniques in images, video, audio and documents, Security in Steganography, Pure key Steganography, Private key Steganography and Public key Steganography, Steganalysis - detection, extraction & recovery of message.

SIL779 Data Privacy
3 Credits (3 -0-0)

Information Security and Privacy: the big picture, A gentle introduction to cryptography, Certificates, PKI, Decentralized Trust Management,

Authentication – incl. authentication infrastructure and protocols, Information Security: Legal landscape, Cybercrime, Information Privacy: Concepts and Regulatory Landscape, Privacy Enhancing Technologies, Methods of tracking and de-identification (Breaking users' privacy: packet sniffing, First-party data collection; third-party data collection: how ad networks work; surveillance by ISPs, Tracking users: cookie tracking, ads, Understanding privacy threat models.), Information Security as Risk management, Trusted Computing, Mobile Security, Privacy and Big Data, Web Attacks, Systems Security, Social Networking and Privacy, Usable Security and Privacy.

SIL777 Secure Programming Methodologies

4 Credits (3-0-2)

Prerequisite(s) : COL331, ELL405

Language level vulnerabilities, secure programming techniques and approaches, input processing, code checking, security testing, the integrity of modules, concurrent issues, random number generation and usage, security primitives, security code review, verification, recommended secure design practices.

SIL781 Secure Hardware-based System Design

4 Credits (3-0-2)

Prerequisite(s) : COL216, ELL305

Overview of Different Issues of Hardware Security, Useful Hardware Security Primitives: Cryptographic Hardware and their Implementation, Optimization of Cryptographic Hardware on FPGA, Physically Unclonable Functions (PUFs) with implementations and quality evaluation Side-channel Attacks on Cryptographic Hardware: Basic Idea, Prevention, Improved Side-channel Attack Algorithms, Cache Attacks, Testability and Verification of Cryptographic Hardware: Fault-tolerance of Cryptographic Hardware, Fault Attacks, Verification of Finite-field Arithmetic Circuits, Modern IC Design and Manufacturing Practices and Their Implications: Hardware Intellectual Property (IP) Piracy and IC Piracy, Prevention of IP and IC Piracy, Hardware Piracy,

Model Building Attacks on PUFs, Hardware Trojans: Nomenclature and Operating Modes, Countermeasures, Techniques for Trojan Detection, Techniques to Increase Testing Sensitivity Infrastructure Security: Impact of Hardware Security Compromise on Public Infrastructure, Defense Techniques.

JCP781 Data Structures and Algorithms Lab

1 Credit (0-0-2)

Prerequisite(s) : Computer programming. This course is to be taken in conjunction with ELL781 and covers the lab component of the theory covered there.

This course is to be taken in conjunction with ELL781 and covers the lab component of the theory covered there viz Basics of algorithm analysis. Elementary data structures. Hashing, Analysis of collision resolution techniques. Priority queues. Dynamic programming: rod cutting problem, matrix multiplication, longest common sequence, optimal binary search tree. Greedy algorithms: Huffman coding, activity selection problem, knapsack problem. Sparse Matrices manipulation. String matching, Matching DNA sequences.

JCP810 Cyber Security and Information Assurance Lab

1 Credit (0-0-2)

Prerequisite(s) : To be taken in parallel with ELL810. This is for lab component of the topics covered in ELL810

This is a lab only course to be taken in conjunction with ELL810. The labs will be on topics covered therein viz Basics of computer and networks security along with vulnerabilities in existing software interfaces, such as buffer overflows, unsafe libc functions, filesystem design issues, etc. The associated threat, attack, adversary models, identity representation, management and access control, intrusion detection, security at different levels: network, system, user, program security, network security, wireless security, mobile security, hardware security and the security of cyber physical systems.

Abbreviations

BAP	Board of Academic Programmes
B.Tech.	Bachelor of Technology
CGPA	Cumulative Grade Point Average
CRC	Centre Research Committee
DGPA	Degree Grade Point Average
D.I.I.T.	Diploma of I.I.T. Delhi
DRC	Department Research Committee
EC	Earned Credits
IRD	Industrial Research and Development
M.B.A.	Master of Business Administration
M.Des.	Master of Design
M.Sc.	Master of Science
M.S.(R)	Master of Science (Research)
M.Tech.	Master of Technology
PGS&R	Postgraduate Studies and Research
Ph.D.	Doctor of Philosophy
SGPA	Semester Grade Point Average
SRC	Student Research Committee (for M.S.(R) and Ph.D. student)
SRC	Student Research Committee (in respect to School)
UGS	Undergraduate Studies
PGS	Postgraduate Studies
IDDC	Industrial Design and Development Centre
ITMMEC	Industrial Tribology Machine Dynamics and Maintenance Engineering Centre
EWS	Economically Weaker Section

Slot Timings (General – 4 Cycles)

Day	8-850	9-950	10-1050	11-1150	12-1250	Cycle No.	1-150	2-250	3-350	4-450	5-550	6-650	
Monday	A		B	H	J	1	TE1		PE1		M		
						2	TF2		PF2				
						3		PB3		PC3			
						4	TA4	TD4		PD4			
Tuesday	C	D	E	F	J	1	TA1	TD1		PD1	K	L	
						2	TE2		PE2				
						3	TF3		PF3				
						4		PB4		PC4			
Wednesday	C	D	E	H	K	1	L/TG1	TG2	Seminar / Meeting / Project Activity				
						2							
						3							
						4							
Thursday	A		B	F	H	1		PB1		PC1	M		
						2	TA2	TD2		PD2			
						3	TE3		PE3				
						4	TF4		PF4				
Friday	C	D	E	F	J	1	TF1		PF1		K	L	
						2		PB2		PC2			
						3	TA3	TD3		PD3			
						4	TE4		PE4				

Note:

- Five-cycle lab / tutorial schedule would have lab / tutorial classes also on wednesday between 1-5 p.m.
- TG1 and TG2 are slots for courses that would like all groups to have tutorials together or in parallel at the same time.









INDIAN INSTITUTE OF TECHNOLOGY DELHI

THE HONOUR CODE

I, Entry No..... do hereby undertake that as a student at IIT Delhi :

- 1) I will not give or receive aid in examinations; that I will not give or receive unpermitted aid in class work, in preparation of reports, or in any other work that is to be used by the instructor as the basis of grading; and
- 2) I will do my share and take an active part in seeing to it that others as well as myself uphold the spirit and letter of the Honour Code.

I realise that some examples of misconduct which are regarded as being in violation of the Honour Code include :

-  Copying from another's examination paper or allowing another to copy from one's own paper;
-  Unpermitted collaboration;
-  Plagiarism;
-  Revising and resubmitting a marked quiz or examination paper for re-grading without the instructor's knowledge and consent;
-  Giving or receiving unpermitted aid on take home examinations;
-  Representing as one's own work, the work of another, including information available on the internet;
-  Giving or receiving aid on an academic assignment under circumstances in which a reasonable person should have known that such aid was not permitted; and
-  Committing a cyber-offence, such as, breaking passwords and accounts, sharing passwords, electronic copying, planting viruses, etc.

I accept that any act of mine that can be considered to be an Honour Code violation will invite disciplinary action.

Date.....

Student's Signature.....

Name.....

Entry No.....



Indian Institute of Technology Delhi

Hauz Khas, New Delhi-110 016 (India)

www.iitd.ac.in